



Tél. 04 73 84 84 94
info@palserviceminute.com

EL LIDER EN TECNOLOGÍA
THE LEADER IN TECHNOLOGY

EL LIDER EN CALIDAD
THE LEADER IN QUALITY

**EL LIDER EN COMPROMISO
MEDIOAMBIENTAL**
THE LEADER IN THE COMMITMENT
TO THE ENVIRONMENT

EL LIDER EN SERVICIO
THE LEADER IN SERVICE

A4-A20 **JMA, LA LLAVE DE LA EXCELENCIA**
JMA, BIKAIN TASUNAREN GILTZA
JMA, THE KEY TO EXCELLENCE
JMA, LA CLE DE L'EXCELLENCE
JMA, DER SCHLÜSSEL ZUR EXZELLENZ

JMA Konpromisoa da
JMA is Commitment
JMA, l'engagement
JMA bedeutet Verpflichtung

A6-A7 **JMA, el Líder**
JMA Liderra
JMA the Leader
JMA, le Leader
JMA der Marktführer

A8-A9 **JMA en el Mundo**
JMA Munduan
JMA Worldwide
JMA dans le Monde
JMA in der Welt

A10-A13 **Tipos de Llaves**
Giltza Motak
Key Types
Types de Clés
Schlüsseltypen

A14-A15 **Manual de uso**
Erabilera-eskuliburua
Manual of use
Manuel d'utilisation
Handbuch

A16-A17 **Descripción y Terminología**
Deskribapen eta Terminologia
Description and Terminology
Description et Terminologie
Begriffserklärung und Terminologie

A18-A19 **Símbolos y Nacionalidades**
Ikur eta Nazionalitateak
Symbols and Nationalities
Symboles et Nationalités
Symbole und Nationalitäten

A21-A54 **ÍNDICES**
AURKIBIDEAK
CONTENTS
TABLES DES MATIERES
INHALT

A21-A42 **Índice General**
Aurkibide Orokorra
General Index
Index Generale
Gesamtverzeichnis

A43-A54 **Índice de Marcas**
Marken Aurkibidea
Brand Index
Index Marque
Hauptmarke

01-350 **TIPOS DE LLAVES**
GILTZA MOTAK
TYPES OF KEYS
TYPES DE CLÉS
SCHLÜSSELTYPEN

01-158 **Llaves Planas para Cerraduras de Cilindro**
Sarraila Zilindrikotarako Giltza Zapalak
Cylinder Keys
Clés pour Cylindres
Zylinderschlüssel

159-241 **Llaves para Vehículos**
Ibilgailuentzako Giltzak
Keys for Vehicles
Clés pour Véhicules
Fahrzeugschlüssel

242-244 **Llaves de Cierre**
Ixteko Giltzak
Snap-lock Keys
Clés de Bouche d'eau
Dornschlüssel

245-255 **Llaves en Cruz**
Gurutze-Giltzak
Cruciform Keys
Clés Cruciformes
Kreuzschlüssel

256-276 **Llaves de Gorja Acero Dulce**
Altzairu Gozozko Gorja-Giltzak
Mild Steel Bit Keys
Clés à Gorges en Acier Doux
Chubbschlüssel aus Weichstahl

277-337 **Llaves de Gorja Latón**
Letoizko Gorja Giltzak
Brass Bit Keys
Clés à Gorges en Laiton
Chubbschlüssel aus Messing

338-340 **Llaves de Gorja Zamak**
Zamakezko Gorja Giltzak
Zamak Bit Keys
Clés à Gorges en Zamak
Chubbschlüssel aus Zamak

341-345 **Llaves Artísticas y de Armario Latón**
Letoizko Giltzak: Armairuetarako eta Artistikoak
Brass Furniture Keys
Clés pour Meubles en Laiton
Möbelschlüssel aus Messing

346-347 **Llaves Artísticas y de Armario Zamak**
Zamakezko Giltzak: Armairuetarako eta Artistikoak
Zamak Furniture Keys
Clés pour Meubles en Zamak
Möbelschlüssel aus Zamak

348-349 **Llaves para Casillas y Ascensores**
Kutxatila eta Iggogailuentzako Giltzak
Lift and Mail Box Keys
Clés pour Ascenseurs et Boîtes à Lettres
Briefkasten- und Liftschlüssel

351-424 **GUIA DE MARCAS**
MARKEN GIDA
MAIN GUIDE
GUIDE DES MARQUES
MARKENINDEX

351-390 **Automovil-Camioneta**
Automobila-Kamioneta
Car-Pick up
Voiture-Camionnette
Auto-Kleintransporter

391-397 **Camión**
Kamioia
Trucks
Camion
Lkw

399-418 **Motocicleta**
Motozikleta
Motorcycle
Motocyclette
Motorrad

419-424 **Alarma - avión - bicicleta - caravana - tapón de gasolina - motor marino - portaesquí - tractor - escavadora - carretilla elevadora - corta césped**

Alarma - Hegazkina - Bizikleta - Karabana - Gasolina Tapoia - Itsas Motorra - Eskieuskaria - Traktorea - Hondeatzaila - Orga Jasotzailea - Belarra Mozteko Makina

Alarm - Airplan - Bicycle - Caravans - Petrol Cap - Boat Engines - Ski Holder - Tractor - Earth Moving Machine - Forklift - Lawn Mower

Alarme - Avion - Bicyclette - Caravane - Bouchon Reservoir - Moteur de Bateau - Porte Ski - Traktor - Machine por Déplacement de Terre - Clark - Tondeuse

Alarm - Flugzeuge - Fahrräder - Wohnwagen - Tankverschlüsse - Schiffsmotoren - Skiträger Landmaschinen - Baummaschinen - Gabelstapler - Rasenmäher

JMA ES COMPROMISO

JMA IS COMMITMENT



FRANÇAIS

NOTRE SUCCÈS EST FONDÉ SUR L'ENGAGEMENT DES PERSONNES

*Alejandro Altuna S.A. est la société-mère qui a donné lieu au Groupe Altuna. Elle fabrique toutes sortes de **clés de serrure et de machines à copier**. Ses produits sont destinés au marché **OEM** et au remplacement, dans ce cas sous la marque **JMA**.*

*Alejandro Altuna en 1942, elle s'est établie à Mondragón. Très vite, une nouvelle génération familiale a misé sur le développement et grâce aux investissements engagés, l'entreprise a connu une forte croissance qui, dans les années 60, a imposé la marque **JMA** à la tête du secteur.*

*Par la suite, la stratégie d'ouverture sur les marchés extérieurs et une volonté d'internationalisation toujours sous-tendue par le recours aux procédés industriels les plus novateurs, a fait du **GROUPE ALTUNA** le **premier producteur de clés européen** et un **réfèrent mondial** dans ce domaine.*

*Actuellement, **15 firmes sur 4 continents** unissent leurs forces pour dynamiser et faire progresser notre marque JMA, connue dans plus de 100 pays du monde entier.*

*Les équipes JMA sont formées de **personnes motivées et pleinement investies** dans un projet commun qui nous a permis de devenir le plus important fabricant de clés d'Europe.*

DEUTSCH

UNSER ERFOLG BASIERT AUF DAS ENGAGEMENT VON MENSCHEN

*Alejandro Altuna S.A. ist die Muttergesellschaft, aus der später die Altuna Group hervorging. Sie stellt **Schlüssel** aller Art sowie **Schlüsselkopiermaschinen** her. Ihre Produkte wenden sich an dem OEM- und den Ersatzschlüsselmarkt, in diesem Fall mit der Markenbezeichnung **JMA**.*

*Das Unternehmen wurde 1942 von Alejandro Altuna gegründet und begann seinen Werdegang in Mondragón. Innerhalb eines nur kurzen Zeitraums sorgte eine neue, auf Entwicklung und Investition setzende Familiengeneration für ein bedeutendes Wachstum und sicherte der Marke **JMA** damit Anfang der 60er Jahre die unbestreitbare Führungsposition im Land.*

*Später dann hat die auf das Konzept der Internationalisierung und der Innovation der industriellen Prozesse gestützte Strategie der Öffnung gegenüber ausländischen Märkten die **ALTUNA GROUP** zum **führenden europäischen Hersteller von Schlüsseln und einem weltweiten Bezugspunkt** für diesen Sektor werden lassen.*

*Derzeit arbeiten **15 Unternehmen in 4 Kontinenten gemeinsam**, um die Stärke der in über 100 Ländern der ganzen Welt bekannten Marke JMA zu potenzieren und weiterzuentwickeln.*

*JMA arbeitet mit Teams **engagierter und motivierter Menschen**, die sich für ein gemeinsames Projekt einsetzen, das es uns möglich gemacht hat, der größte Hersteller von Schlüsseln in Europa zu werden.*

THE KEY TO EXCELLENCE
GLOBALLY UNLOCKING MILLIONS OF DOORS DAILY

ESPAÑOL:

LIDER EN TECNOLOGÍA:

Una apuesta sólida por la calidad y la innovación basada en la automatización y garantía de procesos y soportada por una vocación inversora a largo plazo.

LIDER EN CALIDAD:

En el ámbito de la Calidad Alejandro Altuna S.A. siempre ha sido una empresa líder y pionera en su sector. Nuestra política de calidad se basa en la prevención y planificación, mejora continua, satisfacción del cliente y participación de las personas

Estos valores están impregnados en nuestra empresa desde sus orígenes y han sido, junto con una adecuada política de inversión en instalaciones y maquinaria, el motivo principal de nuestro éxito, que además nos permite asegurar la competitividad de la empresa y con ello el futuro a largo plazo.

Además de la Certificación en Calidad de acuerdo a la ISO 9001, Alejandro Altuna S.A. acoge Sistemas de Gestión de la Calidad homologados por las empresas líderes del sector de automoción y residencial. Actualmente nuestra empresa es reconocida en el mercado como líder en este campo.



LIDER EN EL COMPROMISO POR EL MEDIO AMBIENTE:

En Alejandro Altuna S.A. las buenas prácticas medioambientales son la norma y no la excepción. Nuestro equipo forma parte de un proyecto de empresa respetuoso con el medioambiente y que colabora con el desarrollo sostenible de nuestro entorno.

Alejandro Altuna S.A. fue el primer fabricante mundial de llaves en conseguir en 2000 el certificado ISO 14001 para su Sistema de Gestión. Este Sistema incorpora la política medioambiental, donde se recogen los valores y compromisos de la empresa, así como procedimientos que desarrollan los sistemas de trabajo y garantizan las correctas prácticas medioambientales en todos los ámbitos de la empresa.

LIDER EN SERVICIO:

La realidad de una empresa se demuestra en su capacidad por responder con la máxima celeridad y eficacia a las necesidades y exigencias de los clientes. Se encuentran donde se encuentren. JMA pone a su disposición 5 plantas productivas en localizaciones estratégicas. Además, gracias a su amplia red de filiales y empresas distribuidoras repartidas por todo el mundo, le permite llegar a cualquier cliente, se cual sea su ubicación.



EUSKERA:

LIDERRA TEKNOLOGIAN:

Kalitatearen eta berrikuntzaren aldeko apustua sendoa da, prozesuen automatizazioan nahiz bermean oinarrituta eta epe luzerako inbertsioa eginda.

LIDERRA KALITATEAN:

Kalitatearen arloan, Alejandro Altuna S.A. sektoreko enpresa liderra eta aitzindaria izan da beti. Hona hemen gure kalitate-politikaren oinarriak: prebentzioa, plangintza, etengabeko hobekuntza, bezeroaren poztasuna eta pertsonen partaidetza.

Balio horiek hasiera-hasieratik ezarri dira gure enpresan, eta, instalazio zein makinatan inbertitzeko politika egokiarekin batera, gure arrakastaren arrazoi nagusia izan dira. Horrez gain, enpresaren lehiakortasuna eta epe luzerako etorkizuna bermatzeko aukera ere eskaini digute.

ISO 9001en arabeko kalitate-ziurtagiria ez ezik, Alejandro Altuna S.A. enpresak ibilgailu-industriako eta bizileku-sektoreko enpresa liderrek homologatutako kalitate-kudeaketarako sistemak ere baditugu. Gaur egun, merkatuaren arabera, gure enpresa liderra da arlo horretan.

LIDERRA INGURUMENAREKIKO KONPROMISOAN:

Alejandro Altuna S.A. enpresan, ingurumen-arloko jarduera egokiak ez dira salbuespena, araua baizik. Gure taldea ingurumena errespetatu eta ingurunearen garapen iraunkorra sustatzen duen enpresa-proiektuaren barruan dago.

2000. urtean, Alejandro Altuna S.A. bere kudeaketa-sistemarako ISO 14001 ziurtagiria lortu zuen lehen giltzagilea izan zen munduan. Ingurumen-politika sistema horren barruan dago kokatuta, eta, bertan, enpresaren balioak zein konpromisoak azaltzen dira, baita lan-sistemak garatu eta enpresako arlo guztietan ingurumen-jarduera egokiak bermatzeko prozedurak ere.

LIDERRA ZERBITZUAN:

Edonon daudela ere, bezeroen premiei eta eskakizunei ahalik eta azkarren eta era eraginkorrean erantzuteko daukan gaitasuna da enpresaren errealitatearen adierazgarri.

JMAk 5 ekoizpen-lantegi ditu leku estrategikoetan. Gainera, bere filialen sarea zabalaren eta banaketa-enpresak mundu zabalean barreiatuta daudenez, edozein bezerorengana heldu daiteke, edonon dagoela ere.

JMA, EL LIDER

JMA, THE LEADER

ENGLISH:

THE LEADER IN TECHNOLOGY:

Looking for the latest developments to improve the production processes together with a strong investment policy in all our plants to ensure the company's competitiveness and long-term future.

THE LEADER IN QUALITY:

As far as Quality is concerned, Alejandro Altuna S.A. has always been a leading, pioneering company in its sector. Our quality policy is based on prevention and planning, continuous improvement, customer satisfaction and people participation.

These values have been impregnated in our company from the start and have been, together with a good investment policy in terms of equipment and machinery, the main reason behind our success, which moreover enables us to ensure the company's competitiveness and long-term future.

In addition to Quality Certification to ISO 9001, Alejandro Altuna S.A. operates Quality Management Systems approved by the leading companies in the automotive and residential sectors. Our company is currently recognised in the market as a leader in this field.

THE LEADER IN THE COMMITMENT TO THE ENVIRONMENT:

At Alejandro Altuna S.A. best environmental practice is the norm and not the exception. Our team is part of a business project that respects the environment and contributes to the sustainable development of our community.

Alejandro Altuna S.A. was the first key manufacturer in the world to achieve ISO 14001 certification for its management system in 2000. This system incorporates the environmental policy, which includes the company's values and commitments, as well as procedures to set out the work systems and ensure good environmental practice throughout the company.

THE LEADER IN SERVICE:

The efficiency of a company is shown in its capacity to respond with the maximum speed and effectiveness to the needs and requirements of its customers, wherever they are based.

JMA places at your disposal 5 production plants based in strategic locations. Moreover, with its extensive network of associate and distribution companies located throughout the world, the company can reach any customer, wherever based.

FRANÇAIS:

LEADER EN TECHNOLOGIE:

Un pari résolu sur la qualité et l'innovation basée sur l'automatisation et la garantie des process et soutenu par une vocation d'investissement à long terme.

LEADER EN QUALITÉ:

Dans le domaine de la Qualité, Alejandro Altuna S.A. a toujours été une entreprise pionnière et leader de son secteur. Notre politique de qualité est assise sur la prévention et planification, l'amélioration continue, la satisfaction du client et la participation des personnes. Ces valeurs irriguent notre entreprise depuis sa création. Soutenues par une politique constante d'investissement en installations et machines, elles expliquent, notre succès et, de plus, nous permettent d'assurer la compétitivité de l'entreprise et donc notre futur à long terme.

Bénéficiant de la Certification de Qualité selon la norme ISO 9001, Alejandro Altuna S.A. s'appuie sur des systèmes de gestion de la qualité homologués par les principaux constructeurs, aussi bien automobiles que du bâtiment. Aujourd'hui, notre entreprise est reconnue par le marché comme le leader du secteur.

LEADER EN ENGAGEMENT ENVIRONNEMENTAL:

Pour Alejandro Altuna S.A., les bonnes pratiques environnementales sont la règle et non l'exception. Notre équipe fait partie d'un projet entrepreneurial respectueux de l'environnement qui collabore au développement durable de notre milieu.

Alejandro Altuna S.A. a été le premier fabricant mondial de clés à obtenir, dès 2000, le certificat ISO 14001 pour son système de gestion. Ce système comporte deux piliers: la politique environnementale, où sont définis les valeurs et les engagements de l'entreprise, et les procédures qui développent les systèmes de travail et qui garantissent les bonnes pratiques environnementales dans tous les domaines d'activité.

LEADER EN SERVICE:

La réalité d'une entreprise se démontre par sa capacité à répondre le plus promptement et le plus efficacement possible aux besoins et aux exigences des clients. Où qu'ils se trouvent.

JMA place à leur disposition 5 sites de production situés dans des lieux stratégiquement choisis. De plus, grâce à notre vaste réseau de filiales et de distributeurs répartis dans le monde entier, nous pouvons toucher tous nos clients, où qu'ils soient.

DEUTSCH:

FÜHREND IN TECHNOLOGIE:

Ein solider Einsatz für die Qualität und die Innovation, der sich auf Automatisierung und Prozesssicherheit sowie eine langfristige Investitionsgrundlage stützt.

FÜHREND IN QUALITÄT:

Auf dem Gebiet der Qualität war Alejandro Altuna S.A. stets ein führendes und bahnbrechendes Unternehmen des Sektors. Unsere Qualitätspolitik basiert auf Prävention und Planung, ständiger Verbesserung, Kundenzufriedenheit und Einbeziehung der Mitarbeiter.

Diese Werte sind schon seit den Anfängen fester Bestandteile unseres Unternehmens. Gemeinsam mit einer angemessenen Politik der Investition in Anlagen und Maschinenpark waren sie der wichtigste Grund für unseren Erfolg und sichern darüber hinaus die Wettbewerbsfähigkeit des Unternehmens und damit seine langfristige Zukunft.

Neben der Qualitätszertifizierung nach ISO 9001 verfügt Alejandro Altuna S.A. über Qualitätsmanagementsysteme, die von den führenden Automobil- und Wohnungsbauunternehmen zugelassen sind. Derzeit ist unser Unternehmen auf dem Markt für seine führende Position im Bereich Qualität bekannt.

FÜHREND IM UMWELTSCHUTZ:

Bei Alejandro Altuna S.A. sind gute Umweltpraktiken die Regel, nicht die Ausnahme. Unsere Mitarbeiter sind Teil des Projekts des umweltfreundlichen Unternehmens, das sich für die nachhaltige Entwicklung unserer Umwelt einsetzt. Alejandro Altuna S.A. erhielt im Jahr 2000 als weltweit erster Hersteller von Schlüsseln das Zertifikat ISO 14001 für sein Managementsystem. Dieses System umfasst die Umweltpolitik, die die Werte und Verpflichtungen des Unternehmens sowie die Verfahren für die Herstellungssysteme festlegt, und die korrekten Umweltpraktiken in allen Unternehmensbereichen garantiert.

FÜHREND IM SERVICE:

Die Realität eines Unternehmens zeigt sich in seiner Fähigkeit, in optimalem Zeitrahmen und mit maximaler Effizienz auf die Bedürfnisse und Anforderungen der Kunden zu reagieren, unabhängig davon, wo diese sich befinden. JMA verfügt über 5 Fertigungsstätten an strategischen Standorten. Dank eines über die ganze Welt ausgedehnten Netzes von Filialen und Vertriebshändlern ist das Unternehmen immer in der Nähe seiner Kunden, egal wo.

**15 COMPAÑÍAS EN 15 PAÍSES
600 PERSONAS Y
MÁS DE 550 MILLONES DE LLAVES AL AÑO
EN MÁS DE 100 PAÍSES EN TODO EL MUNDO.**

**El potencial de JMA en el mundo está cimentado a través de sus plantas productivas y filiales comerciales en Europa, América del Norte y del Sur, Asia y África.
La internacionalización es una estrategia prioritaria en JMA.**

JMA MUNDUAN

15 konpainia 15 herrialdeetan; 600 pertsona eta 550 milioitik gora giltza urtean, mundu zabaleko 100etik gora herrialdeetan.

JMA enpresak ahalmena du munduan, ekoizpen-lantegiak eta filial komertzialak dituelako Europan, Ipar Amerikan, Hego Amerikan, Asian eta Afrikan.
Izan ere, nazioarteko bihurtzea lehentasunezko estrategia da JMArentzat.

JMA WORLDWIDE

15 companies in 15 countries; 600 people and over 550 million keys sold in more than 100 countries all over the 5 continents

JMA's potential worldwide is based on its production plants and commercial subsidiaries in Europe, North and South America, Asia and Africa.
Globalisation is a priority strategy for JMA.

JMA DANS LE MONDE

15 sociétés dans 15 pays ; 600 personnes et plus de 550 millions de clés vendues chaque année dans plus de 100 pays de quatre continents

Le potentiel de JMA dans le monde est solidement ancré dans un réseau de production et de distribution qui couvre l'Europe, les deux Amériques, l'Asie et l'Afrique.
L'internationalisation est une stratégie prioritaire pour JMA.

JMA IN DER WELT

15 Unternehmen in 15 Ländern; 600 Personen und über 550 Millionen Schlüssel pro Jahr in über 100 Ländern der ganzen Welt.

Das Leistungspotenzial von JMA in der ganzen Welt wird durch seine Produktionsstätten und Handelsfilialen in Europa, Nord- und Südamerika, Asien und Afrika konsolidiert. Internationalisierung ist eine vorrangige Strategie von JMA.



JMA EN EL MUNDO

JMA WORLDWIDE

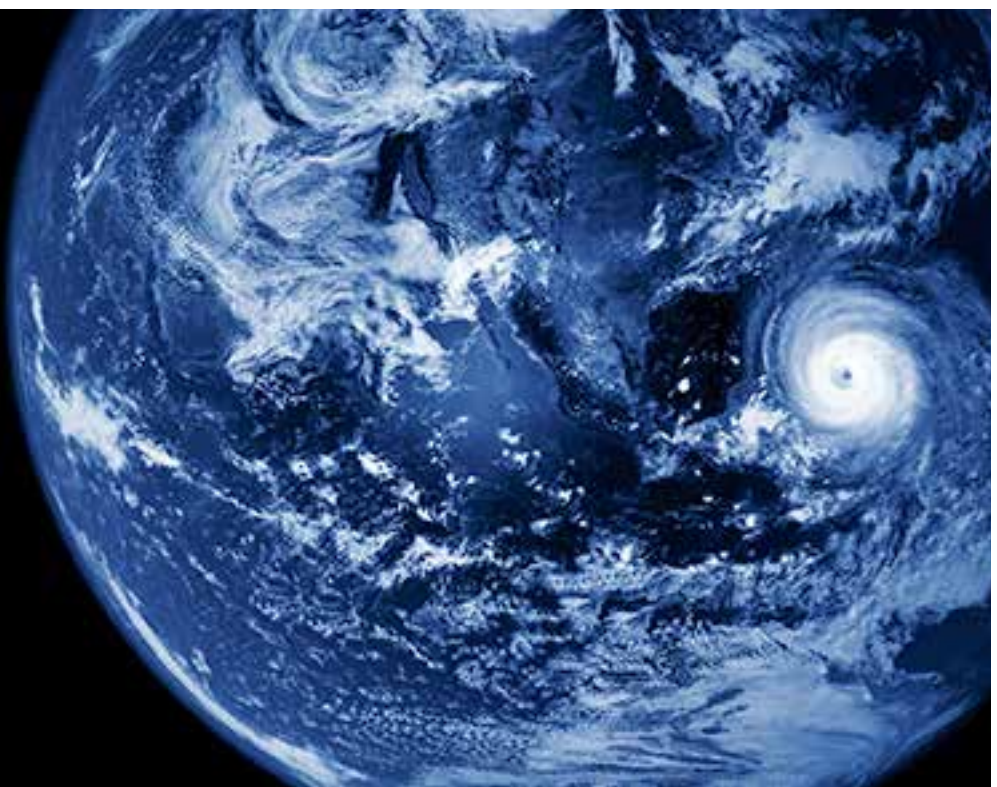

THE KEY TO EXCELLENCE
GLOBALLY UNLOCKING MILLIONS OF DOORS DAILY

01-158

LLAVES PLANAS PARA CERRADURAS DE CILINDRO

SARRAILA ZILINDRIKOTA-
RAKO GILTZA ZAPALAK

CYLINDER KEYS

CLÉS POUR CYLINDRES

ZYLINDERSCHLÜSSEL



159-241

LLAVES PARA VEHÍCULOS

IBILGAILUENTZAKO
GILTZAK

KEYS FOR VEHICLES

CLÉS POUR VÉHICULES

FAHRZEUGSCHLÜSSEL



242-244

LLAVES DE CIERRE

IXTEKO GILTZAK

SNAP-LOCK KEYS

CLÉS DE BOUCHE D'EAU

DORNSCHLÜSSEL



245-255

LLAVES EN CRUZ

GURUTZE-GILTZAK

CRUCIFORM KEYS

CLÉS CRUCIFORMES

KREUZSCHLÜSSEL



256-276

LLAVES DE GORJA ACERO DULCE

ALTZAIRU GOZOZKO
GORJA-GILTZAK

MILD STEEL BIT KEYS

CLÉS À GORGES EN ACIER DOUX

CHUBBSCHLÜSSEL
AUS WEICHSTAHL



TIPOS DE LLAVES

KEY TYPES

277-337

LLAVES DE GORJA LATÓN

LETOIZKO GORJA GILTZAK

BRASS BIT KEYS

CLÉS À GORGES EN
LAITON

CHUBBSCHLÜSSEL AUS
MESSING

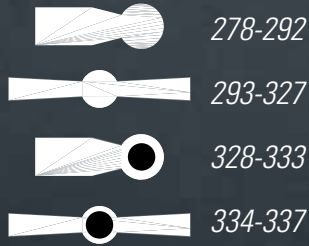

338-340

LLAVES DE GORJA ZAMAK

ZAMAKEZKO GORJA
GILTZAK

ZAMAK BIT KEYS

CLÉS À GORGES EN ZAMAK

CHUBBSCHLÜSSEL AUS
ZAMAK



341-345

LLAVES ARTÍSTICAS Y DE ARMARIO LATÓN

LETOIZKO GILTZAK:
ARMAIRUETARAKO
ETA ARTISTIKOAK

BRASS FURNITURE KEYS

CLÉS POUR MEUBLES EN LAITON

MÖBELSCHLÜSSEL
AUS MESSING



346-347

LLAVES ARTÍSTICAS Y DE ARMARIO ZAMAK

ZAMAKEZKO GILTZAK:
ARMAIRUETARAKO
ETA ARTISTIKOAK

ZAMAK FURNITURE KEYS

CLÉS POUR MEUBLES EN ZAMAK

MÖBELSCHLÜSSEL AUS ZAMAK



348-349

LLAVES PARA CASILLAS Y ASCENSORES

KUTXATILA ETA
IGOGAILUENTZAKO GILTZAK

LIFT AND MAIL BOX KEYS

CLÉS POUR ASCENSEURS ET
BOITES A LETTRES

BRIEFKASTEN- UND
LIFTSSCHLÜSSEL



THE KEY TO EXCELLENCE
GLOBALLY UNLOCKING MILLIONS OF DOORS DAILY

GRABADAS

GILTZA GRABATUAK
COINED KEYS
CLÉS FRAPÉES
PRÄGESCHLÜSSEL

*Consultar Referencias
Erreferentziak Kontsultatu
Check References
Voir Références
Referenzen Konsultieren*



ALUMINIO

*Consultar Referencias
Erreferentziak Kontsultatu
Check References
Voir Références
Referenzen prüfen*



WIND-COLOR

*Consultar Referencias
Erreferentziak Kontsultatu
Check References
Voir Références
Referenzen prüfen*



COLORMATIC

*Consultar Referencias
Erreferentziak Kontsultatu
Check References
Voir Références
Referenzen prüfen*



LLAVES ESPECIALES

SPECIAL KEYS

FASHION

*Consultar Referencias
Erreferentziak Kontsultatu
Check References
Voir Références
Referenzen prüfen*



PET COLLECTION

*Consultar Referencias
Erreferentziak Kontsultatu
Check References
Voir Références
Referenzen prüfen*



STYL COLOR

*Consultar Referencias
Erreferentziak Kontsultatu
Check References
Voir Références
Referenzen prüfen*



Tél. 04 73 84 84 94
info@palserviceminute.com

THE KEY TO EXCELLENCE
GLOBALLY UNLOCKING MILLIONS OF DOORS DAILY

ESPAÑOL

AVISO LEGAL - CATÁLOGO GENERAL C.11

Las llaves que aparecen en este catálogo son piezas JMA fabricadas por Alejandro ALTUNA S.A. o un subcontratista de éste. Están diseñadas para cilindros y cerraduras de los fabricantes cuyas marcas se indican en este catálogo.

Conforme a las disposiciones legales vigentes relativas a la propiedad industrial, las marcas o nombres comerciales indicados en este catálogo son propiedad exclusiva de los fabricantes de cilindros y cerraduras, así como de los fabricantes de automóviles, otros constructores, distribuidores y usuarios.

Dichas marcas o nombres comerciales se indican en calidad simplemente informativa con el fin de reco-

nocer con rapidez la cerradura a la que corresponden nuestras piezas.

Este catálogo está reservado exclusivamente a profesionales de la reproducción de llaves que utilizan piezas JMA.

Los datos referentes a los productos de este catálogo tienen carácter indicativo. Manteniendo siempre las características básicas, nos reservamos el derecho de realizar, sin previo aviso, modificaciones técnicas, estéticas o de otro tipo, por razones de evolución de los productos en cuestión.

Algunos modelos que están en este nuevo catálogo podrán recibirlos tanto con la marca y la referencia JMA como con otra marca del grupo ALTUNA.

EUSKERA

LEGE-OHARRA - KATALOGO OROKORRA C.11

Katalogo honetan ageri diren giltzak Alejandro ALTUNA SA enpresak edo honek kontratatutako beste enpresa batek egindako JMA piezak dira. Katalogoan zehazten diren marken fabrikatzaileen zilindro eta sarrailetarako diseinatuta daude.

Jabetza industrialari buruz indarrean dauden lege-xedape-nekin bat etorri, katalogo honetan zehaztutako merkataritza-markak edo izenak zilindro eta sarraileen fabrikatzaileen nahiz ibilgailuen fabrikatzaileen eta beste erakitzailen, banatzaileen eta erabiltzaileen batzuen jabetza eskusibokoak dira.

Merkataritza-marka edo izen horiek zehaztasun gehiago emateko adierazten dira, gure piezak zein sarraileari dagozkion berehala ikusi ahal izateko.

Katalogo hau giltzen kopiari egiteko JMA piezak erabiltzen dituzten profesionalentzako da soilik.

Katalogo honetako produktuei buruzko datuek izaera adierazgarria dute. Oinarriko ezaugarriak gordez, produktuen bilakaeraren ondoriozko aldaketak teknikoak, estetikoak edo bestelakoak egiteko eskubidea dugu, aurretik horren berri eman beharrik gabe.

Katalogo berri honetan dauden eredu eta batzuk JMA marka eta erreferentziarekin nahiz ALTUNA taldeko beste marka batekin jaso ahal izango dira.

ENGLISH

LEGAL WARNING - GENERAL CATALOGUE C.11

The keys that appear in this catalogue are JMA parts manufactured by Alejandro ALTUNA S.A. or one of its subcontractors. They are designed for cylinders and locks made by the manufacturers whose trademarks are indicated in this catalogue.

In accordance with legal requirements relating to industrial property rights, the trademarks or trade names indicated in this catalogue are the exclusive property of the manufacturers of the cylinders and locks, as well as automobile manufacturers, other constructors, distributors and users.

The aforementioned trademarks or trade names are indicated simply for information purposes so that the lock to which our parts correspond can be recognised quickly and easily. This catalogue is for the exclusive use of professional key copiers who use JMA parts.

Data referring to the products in this catalogue are indicative in nature. Although the basic characteristics are maintained at all times, we reserve the right to make, without previous notice, any technical, aesthetic or other types of changes involved in the development of the products in question.

Some of the keys in this new catalogue could be received either with the JMA reference and trademark or with another trademark from the ALTUNA group.

FRANÇAIS

MENTIONS LEGALES - CATALOGUE GENERALE C.11

Les ébauches de clés reportées sur ce catalogue sont des ébauches JMA fabriquées par Alejandro ALTUNA S.A. ou un de ses sous-traitants Elles sont destinées aux cylindres et serrures des fabricants dont les marques sont indiquées dans ce catalogue.

Conformément aux dispositions légales en vigueur relatives à la propriété industrielle, les marques ou les dénominations commerciales citées dans ce catalogue sont la propriété exclusive des fabricants de cylindres et de serrures ainsi que des constructeurs de voitures, autres constructeurs, distributeurs et utilisateurs.

Ces marques ou dénominations commerciales sont indiquées à titre de simple information afin de connaître rapidement à quelle serrure nos ébauches sont destinées.

Ce catalogue est exclusivement réservé aux professionnels de la reproduction de clés, utilisant des ébauches JMA.

Les renseignements sur les produits de ce catalogue sont donnés à titre indicatif. Tout en gardant les caractéristiques de base, nous nous réservons le droit d'apporter, sans préavis, des modifications techniques, esthétiques ou autres, dues à l'évolution des produits en question.

Des ébauches de ce catalogue pourront être livrées soit avec la marque et référence JMA soit avec une autre marque du groupe ALTUNA.

DEUTSCH

IMPRESSUM- GESAMTKATALOG C.11

Die in dem vorliegenden Katalog aufgeführten Schlüssel sind JMA-Teile, die von der Firma Alejandro ALTUNA, S.A., einem Zulieferanten von JMA, hergestellt werden. Sie sind für Zylinder und Schlösser derjenigen Hersteller entwickelt worden, deren Marken in diesem Katalog aufgeführt sind.

In Übereinstimmung mit den geltenden gesetzlichen Vorschriften bezüglich des gewerblichen Eigentums sind die im vorliegenden Katalog aufgeführten Marken und Firmennamen ausschließliches Eigentum der Zylinder- und Schloßhersteller, sowie der Automobilhersteller und anderer Konstrukteure, Vertrieber und Benutzer.

Diese Marken und Firmennamen werden nur zu Informationszwecken aufgeführt, mit dem Ziel, auf schnelle Weise zu erkennen, zu welchem Schloß unsere Teile gehören.

Dieser Katalog ist ausschließlich für Fachleute des Bereichs der Schlüsselreproduktion gedacht, die JMA-Teile verwenden.

Die Daten bezüglich der Produkte des vorliegenden Katalogs haben informativen Charakter. Bei Aufrechterhaltung der grundlegenden Eigenschaften behalten wir uns das Recht vor, aus Gründen der Entwicklung der entsprechenden Produkte und ohne Vorankündigung technische, ästhetische oder andere Änderungen vorzunehmen. Einige Modelle des neuen Katalogs können Sie sowohl mit der Marke und der Bezeichnung JMA erhalten, als auch mit jeder anderen Marke der Gruppe ALTUNA.

THE KEY TO EXCELLENCE

GLOBALLY UNLOCKING MILLIONS OF DOORS DAILY



MANUAL DE USO

MANUAL OF USE

ESPAÑOL

MANUAL DE USO

Todas las llaves del catálogo están en escala 1:1; tanto la silueta como el perfil, para hacer una búsqueda más fácil y precisa. Pasos a seguir para la identificación de la llave:

1. Identificación de la silueta: Confirmar que la llave que busca coincide con las dimensiones de la llave catálogo. Ver Fig. 1

2. Identificación del perfil:

2.1 Ver si el perfil de la llave y el perfil del catálogo forman una misma imagen. Ver Fig. 2.1

2.2 Cerciorar que el perfil del catálogo tiene la misma forma y dimensión, colocando la llave física sobre la imagen del catálogo. Ver Fig. 2.2

EUSKERA

ERABILERA-ESKULIBURUA:

Katalogoko giltza guztiak 1:1 eskalan agertzen dira; hala silueta nola profila, bilaketa errazagoa eta zehatzagoa izan dadin. Giltza identifikatzeko urratsak:

1. Silueta identifikatzea: Bilatzen den giltzak katalogoan agertzen den giltzaren dimentsio bera duela baiezatu. Ikus 1. irudia.

2. Profila identifikatzea:

2.1 Giltzaren profilak eta katalogoko profilak irudi bera osatzen duten ikusi. Ikus 2.1. irudia.

2.2 Katalogoko profilak forma eta dimentsio bera duela ziurtatzea, giltza fisikoa katalogoko irudiaren gainean jarri. Ikus 2.2. irudia.

ENGLISH

MANUAL OF USE

All the keys in this catalogue are 1:1 scale; both the silhouette outline and profile, to facilitate a precise search. Steps to follow for identifying the key:

1. Identification of the silhouette: Confirm that the key you want matches with the dimensions of the key in the catalogue. See Fig. 1

2. Identification of the profile:

2.1 Check to see if the profile of the original key and the profile in the catalogue have a similar shape. See Fig. 2

2.2 Make sure the profile of the catalogue has the same shape and dimension, by placing the physical key over the image in the catalogue. See Fig. 2.2

FRANÇAIS

MANUEL D'UTILISATION

Toutes les clés du catalogue sont à l'échelle 1:1; aussi bien la silhouette que le profil, afin de permettre une recherche plus simple et précise. Étapes à suivre pour l'identification de la clé :

1. Identification de la silhouette : Confirmer que la clé recherchée correspond aux dimensions de la clé du catalogue. Voir Fig.1

2. Identification du profil :

2.1. Voir si le profil de la clé correspond au profil du catalogue. Voir Fig.2.1

2.2. S'assurer que le profil du catalogue a la même forme et les mêmes dimensions, en plaçant la clé physique sur l'image du catalogue. Voir Fig.2.2

DEUTSCH

HANDBUCH

Alle Schlüssel im Katalog sind im Maßstab 1:1 dargestellt, sowohl als Silhouette als auch im Profil, um die Suche leichter und genauer zu machen. Zu befolgende Schritte für die Identifizierung des Schlüssels:

1. Identifizierung der Silhouette: Bestätigung, dass der gesuchte Schlüssel mit dem Abmessungen im Katalog übereinstimmt. Siehe Abb. 1

2. Identifizierung des Profils:

2.1. Prüfen, ob das Profil des Schlüssels und das im Katalog gezeigte Profil übereinstimmen. Siehe Abb. 2.1

2.2. Vergewissern, dass das Profil im Katalog die gleiche Form und Größe hat, indem man den tatsächlichen Schlüssel auf das Katalogbild legt. Siehe Abb. 2.2

IDENTIFICACIÓN DE LA LLAVE

IDENTIFICACIÓN DE LA LLAVE

1. Identificación de la Silueta

Identificación de la Silueta



2. Identificación del perfil

Identificación del perfil

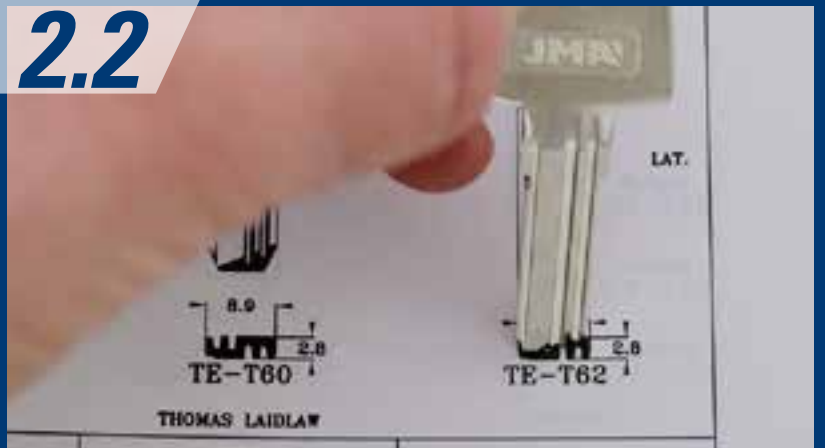

ESPAÑOL

- 1 MARCA PRINCIPAL
- 2 CABEZA
- 3 CUELLO
- 4 TOPE
- 5 PALETÓN
- 6 PUNTA
- 7 UTILIZACIÓN
- 8 NOMENCLATURA DE PERFIL ORIGINAL
- 9 PERFIL IZQUIERDO
- 10 PERFIL DERECHO
- 11 REFERENCIA
- 12 MARCAS SECUNDARIAS
- 13 SERIES
- 14 MARCA PRINCIPAL
- 15 MARCAS SECUNDARIAS DE LA PRINCIPAL (ABSA)

1 ABSA

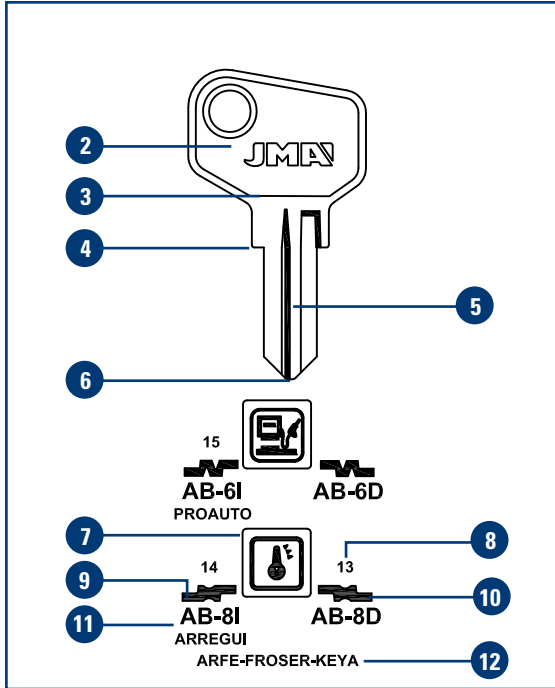

1 VACHETTE

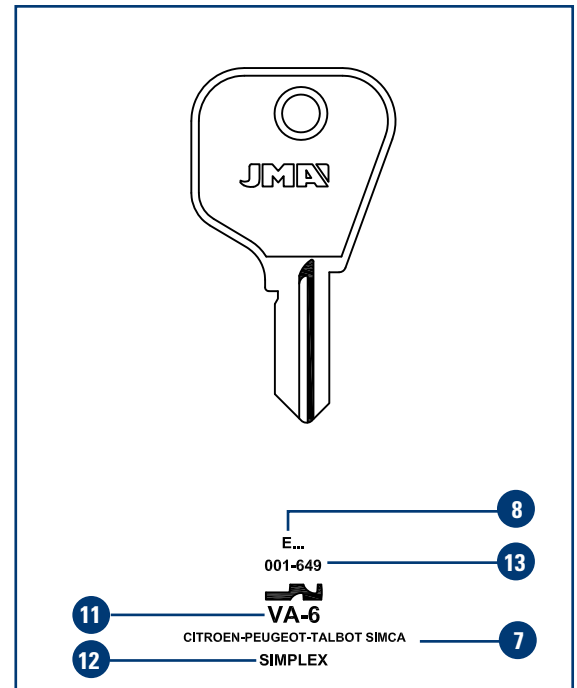

EUSKERA	ENGLISH	FRANÇAIS	DEUTSCH
1 MARKA NAGUSIA	1 MAIN BRAND	1 MARQUE PRINCIPALE	1 HAUPTPRÄGUNG
2 BURUA	2 HEAD	2 TÊTE	2 KOPF
3 LEPOA	3 NECK	3 COU	3 HALS
4 TOPEA	4 SHOULDER	4 ARRÊT	4 ANSCHLAG
5 BELARRIA	5 BLADE	5 CANON	5 SCHAFT
6 PUNTA	6 TIP	6 POINTE	6 SPITZE
7 ERABILERA	7 USE	7 UTILISATION	7 VERWENDUNG
8 JATORRIZKO PROFILAREN IZENDEGIA	8 ORIGINAL PROFILE	8 PROFIL ORIGINAL	8 ORIGINALPROFIL
9 EZKERREKO PROFILA	9 LEFT PROFILE	9 PROFIL GAUCHE	9 LINKSPROFIL
10 ESKUINEKO PROFILA	10 RIGHT PROFILE	10 PROFIL DROIT	10 RECHTSPROFIL
11 ERREFERENTZIA	11 REFERENCE	11 RÉFÉRENCE	11 BEZEICHNUNG
12 BIGARREN MAILAKO MARKAK	12 SECONDARY BRAND	12 MARQUE SECONDAIRE	12 2. PRÄGUNG
13 SERIEAK	13 SERIES	13 CODE	13 SERIE
14 MARCA NAGUSIA ETA JATORRIZKOA	14 MAIN BRAND AND NATIONALITY	14 MARQUE PRINCIPALE ET NATIONALITÉ	14 HAUPTPRÄGUNG UND NATIONALITÄT
15 MARKA NAGUSIAREN BIGARREN MAILAKO MARKAK (ABSA)	15 SECONDARY BRANDS OF THE MAIN ONE (ABSA)	15 MARQUES SECONDAIRES DE LA PRINCIPALE (ABSA)	15 2. PRÄGUNG FÜR HAUPTPRÄGUNG (ABSA)

DESCRIPCIÓN Y TERMINOLOGÍA

KEY DESCRIPTION AND TERMINOLOGY

ESPAÑOL

- 1 CABEZA
- 2 CUELLO
- 3 DIÁMETRO DE LA CAÑA
- 4 CAÑA
- 5 LONGITUD A
- 6 PALETON
- 7 PERFIL MACHO
- 8 REFERENCIA
- 9 MARCA ORIGINAL
- 10 PERFIL HEMBRA

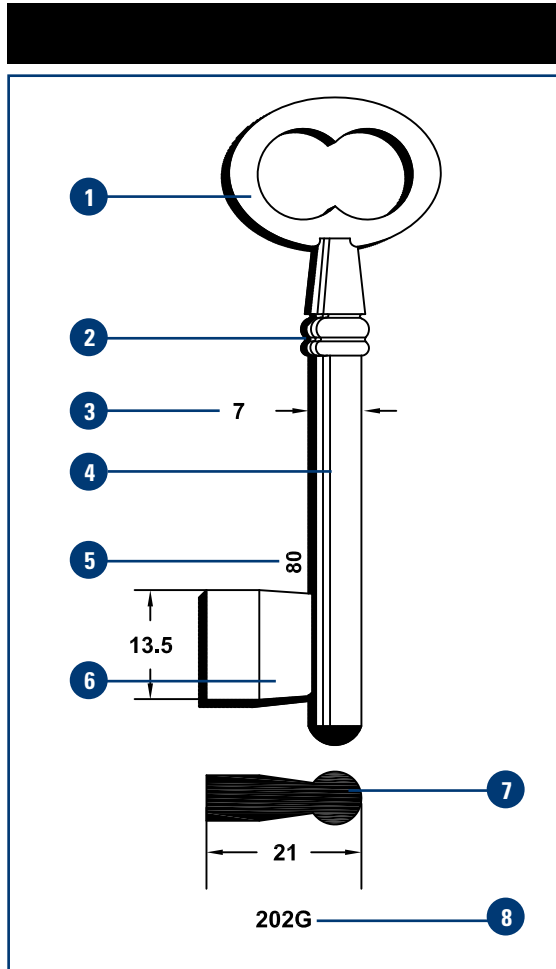

9 — ORENGO

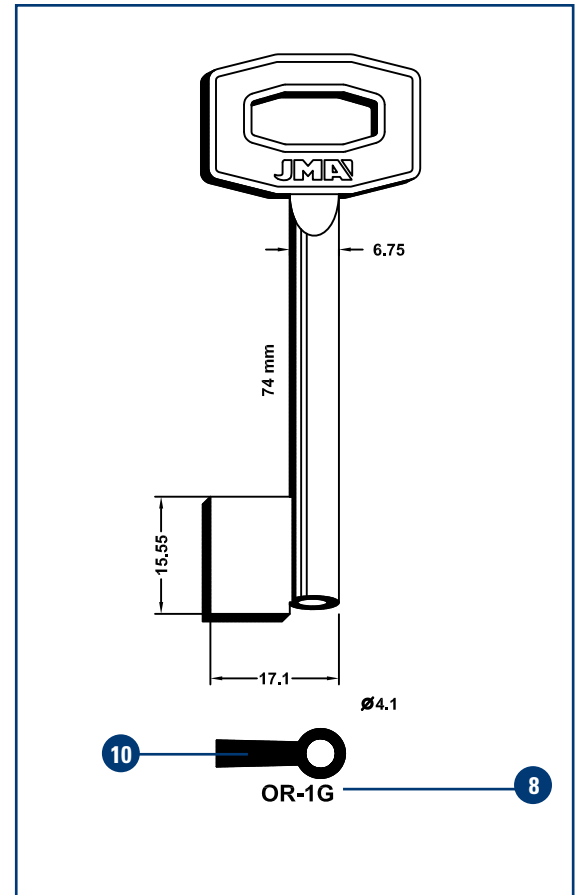

EUSKERA	ENGLISH	FRANÇAIS	DEUTSCH
1 BURUA	1 HEAD	1 TÊTE	1 KOPF
2 LEPOA	2 NECK	2 COU	2 HALS
3 ZIRIAREN DIAMETROA	3 SHANK DIAMETER	3 DIAMETRE DU CANON	3 HALM- DURCHMESSER
4 ZIRIA	4 SHANK	4 CANON	4 HALM
5 A LUZERA	5 LENGTH A	5 LONGUEUR A	5 LÄNGE A
6 BELARRIA	6 BIT	6 PANNETON	6 BART
7 PROFIL ARRA	7 PIN BIT PROFILE	7 PROFIL MALE	7 SCHWEIFUNG
8 ERREFERENTZIA	8 REFERENCE	8 RÉFÉRENCE	8 BEZEICHNUNG
9 JATORRIZKO MARKA	9 ORIGINAL BRAND	9 MARQUE ORIGINALE	9 ORIGINAL- PRÄGUNG
10 PROFIL EMEA	10 PIPE BIT PROFILE	10 PROFIL FEMELLE	10 GEBOHRT

ALP.

Llave fabricada en alpaca

Alpakaz egindako giltza
Key available in nickel silver
Clé fabriquée en maillechort
Schlüssel auch in Neusilber lieferbar

LAT.

Llave disponible también en latón

Giltza, letoizkoa ere eskuragarria
Key also available in brass
Clé aussi disponible en laiton
Schlüssel auch in Messing lieferbar

COL.

Llave disponible también con cabeza de plástico en colores

Giltza hau koloretako plastikozko buruarekin ere eskuragarria

Key also available with coloured plastic head

Clé aussi disponible avec tête plastifiée en couleurs

Schlüssel auch mit farbigem Plastikkopf lieferbar

ALU.

Llave disponible también en aluminio

Giltza, aluminioan ere eskuragarria
Key also available in aluminium
Clé aussi disponible en aluminium
Schlüssel auch in Aluminium lieferbar

ZAM.

Llave fabricada solamente en zamak

Zamakez soilik egindako giltza
Key only available in zamak
Clé aussi disponible en zamak
Schlüssel nur aus Zamak lieferbar



35

Llave de utilizacion en candados

Giltzarrapoetan erabiltzeko giltzak
Key for padlocks
Clé pour cadenas
Schlüssel für Hangschlösser



Llave de utilización en cerraduras auxiliar

Sarraila osagarrietan erabiltzeko giltzak
Key for cam locks
Clé pour petite serrurie
Schlüssel für Hebelschlösser



Llaves para motocicletas

Motozikleta giltzak
Key for motorcycles
Clé pour motocyclettes
Schlüssel für Motorräder



Llave para tapón de gasolina

Gasolina-tapoietarako giltza
Key for fuel cap
Clé pour bouchon d'essence
Schlüssel für Tankdeckel



Llave para camión

Kamioiko giltza
Key for lorries
Clé pour camion
Schlüssel für Lastkraftwagen



Alarma

Alarma
Alarm
Alarme
Alarm



Llaves gorja con acabado en color natural

Gorja giltzak berezko kolorezko akaberarekin
Bit key blank with natural colour finishing
Clé à gorges avec finition en couleur naturel
Chubbsschlüssel in naturfarben Ausführung



Llaves gorja con acabado en negro antiguo

Gorja giltza, beltz zaharkitu akaberarekin
Bit key blank with old black finishing
Clé à gorges avec finition en vieux noir
Chubbsschlüssel in altschwarzer Ausführung

NACIONALIDAD - NAZIONALITATEA - NATIONALITY - NACIONALITÉ - NATIONALITÄT

AUSTRIA
AUSTRALIA
BELGIUM
BRAZIL
CANADA
SWITZERLAND
GERMANY
DENMARK

A
AUS
B
BR
CDN
CH
D
DK

ALGERIA
SPAIN
ESLOVAKIA
EGYPT
FRANCE
GREAT BRITAIN
GREECE
HUNGARY

DZ
E
ES
ET
F
GB
GR
H

HONG KONG
CROATIA
ITALY
ISRAEL
INDIA
EIRE
JAPAN
KOREA

HK
HR
I
IL
IND
IRL
J
K

SÍMBOLOS

SYMBOLS

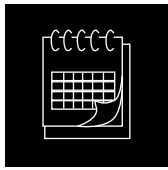

Calendario

Egutegia
Calendar
Calendrier
Kalender

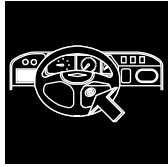

Contacto auto

Autoko kontaktua
Engine ignition
Contact auto
Zündschloss Pkw

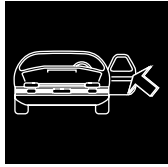

Puerta

Atea
Door lock
Portière
Türe

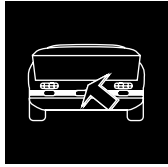

Maletero/Puerta trasera

Maletategia/Atzeko atea
Boot/Hatchback
Coffre/Portière postérieure
Kofferraum/Hecktür



Tapón de gasolina

Gasolina-tapoia
Petrol cap
Bouchon réservoir
Benzintankverschluss

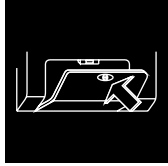

Guantera

Eskularru-kutxa
Drawer
Tiroir
Schublade

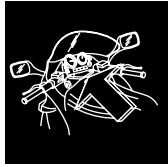

Contacto moto

Moto-kontaktua
Motorbike ignition
Contact moto
Zündschloss Motorrad

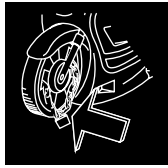

Bloqueo moto

Moto-blokeoa
Motorbike disc lock
Bloquage moto
Bremsenschloss Motorrad

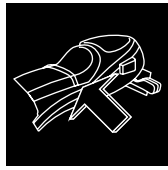

Sillin

Zela
Cycle seat
Selle
Sattel

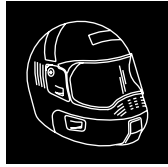

Casco

Kaskoa
Helmet
Casque
Helm



Automovil / camioneta

Automobila / kamioneta
Car / Pick-up trucks
Voiture / Camionnette
Auto / Kleintransporter

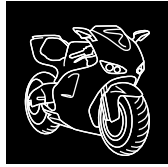

Motocicleta

Motozikleta
Motorcycle
Motocyclette
Motorrad



Camión

Kamioia
Trucks
Camion
Lkw

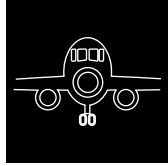

Avión

Hegazkina
Aeroplane
Avion
Flugzeuge

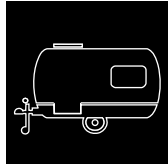

Caravana

Karabana
Caravans
Caravane
Wohnwagen

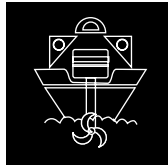

Motor marino

Itsas motorra
Boat engines
Moteur de bateau
Schiffsmotoren

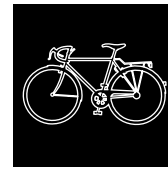

Bicicleta

Bizikleta
Bicycle
Bicyclette
Fahrräder

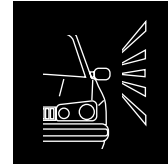

Alarma

Alarma
Alarm
Alarme
Alarm

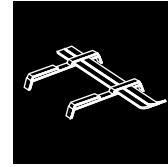

Portaesquis

Eski-euskarria
Ski holder
Porte ski
Skiträger

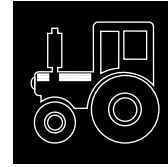

Tractor

Traktorea
Tractor
Traktor
Landmaschinen

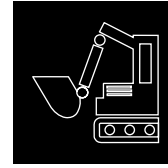

Escavadora

Hondeatzailea
Earth moving machine
Machine déplacement de terre
Baumaschinen

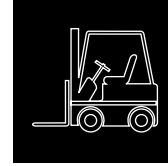

Carretilla elevadora

Orga jasotzailea
Forklift
Clark
Gabelstapler

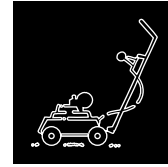

Corta cesped

Belarra mozteko makina
Lawn-mower
Tondeuse
Rasenmäher

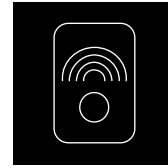

Alarma - llave

Alarma - giltza
Alarm - key
Alarme - clef
Alarm - Schlüssel

KUWAIT
MEXICO
NORWAY
THE NETHERLANDS
PORTUGAL
PERU
POLAND
ARGENTINA

KW
MEX
N
NL
P
PE
PL
RA

TAIWAN
CHILE
CHEKIA
RUMANIA
SWEDEN
FINLAND
SLOVENIA
RUSIA

RC
RCH
RCZ
RU
S
SF
SLO
RJ

CHINA
TUNISIA
UNITED STATES OF AMERICA
YUGOSLAVIA
VENEZUELA
ZAMBIA

TJ
TN
USA
YU
YV
Z

ÍNDICE DE GENERAL

AURKIBIDEA OROKORRA

GENERAL INDEX

INDEX GENERALE

GESAMTVERZEICHNIS



Tél. 04 73 84 84 94

info@palserviceminute.com

THE KEY TO EXCELLENCE
GLOBALLY UNLOCKING MILLIONS OF DOORS DAILY

REF.	PAG.
1G	278
2G	278
3G	278
3M-1D	1
4G	278
5G	278
5-L	135
6-C	146
6G	278
6-L	146
7G	278
7-S	118-349
8G	278
8M-1D	105
11G	279
12G	279
13G	279
14G	279
15-D	223
15G	279
15-I	223
16-D	224
16G	279
16-I	224
17G	279
19G	280
21G	280
23G	280
24G	280
25G	280
26-M	112-349
28-D	162
35-D	146
35-I	146
38-D	146
38-I	146
41-4-4	209
45-1	1
45-1D	1
45-2	1
45-2D	1
48-D	185
48-I	185
51G	328
52G	328
52GPC	328
53G	328
54G	328
55G	328
56G	328
57G	328
66G	329
68G	329
72G	329
73G	329
74G	267
101G	337
126H-60G	283
126N-60G	283

REF.	PAG.
126PP-60G	283
200G	257
201G	257
202G	257
203G	257
204G	257
205G	257
206G	257
207G	258
208G	258
209G	258
210G	258
211G	258
212G	259
213G	259
214G	259
215G	259
216G	259
217G	259
218G	260
219G	260
220G	260
221G	260
222G	260
223G	260
224G	260
225G	260
226G	261
227G	261
228G	261
229G	261
230G	261
231G	261
232G	261
233G	261
234G	262
235G	262
236G	262
237G	262
238G	262
239G	262
303-1	1
303-1D	1
333-1D	1
333-2D	1
500	243
501	243
502	243
503	243
504	243
505	243
506	243
507	243
508	243
509	243
510	243
511	244
512	244
513	244
600G	263

REF.	PAG.
601G	263
602G	263
603G	263
604G	263
605G	263
606G	263
607G	263
608G	264
609G	264
610G	264
611G	264
612G	264
613G	264
614G	265
615G	265
616G	265
618G	265
619G	265
620G	265
622G	266
623G	266
624G	266
625G	266
626G	266
1200G	267
1201G	267
1202G	267
1203G	267
1204G	267
1205G	267
1206G	267
1207G	268
1208G	268
1209G	268
1210G	268
1211G	268
1212G	269
1213G	269
1214G	269
1215G	269
1216G	269
1217G	269
1218G	270
1219G	270
1220G	270
1221G	270
1241G	270
1242G	270
1243G	270
1244G	271
1245G	271
1246G	271
1247G	271
1248G	271
1249G	271
1250G	272
1251G	272
1252G	272
1253G	272

REF.	PAG.
1254G	272
1255G	272
1256G	272
1600G	273
1601G	273
1602G	273
1603G	273
1604G	273
1605G	273
1606G	273
1607G	273
1608G	274
1609G	274
1610G	274
1611G	274
1612G	274
1613G	274
1614G	275
1615G	275
1616G	275
1617G	275
1618G	275
1619G	275
1620G	275
1621G	276
1622G	276
1623G	276
1624G	276
1625G	276
1626G	276

A

A 1(L)	347
A 1(N)	347
A-0G	342
A-0G(CV)	342
A-1G	342
A-1G(CV)	342
A-1G-1	342
A-1G-2	342
A-1G-3	342
A-1G-4	342
A-1G-5	342
A-1G-6	342
A-2G	342
A-2G(CV)	342
A-2G-1	342
A-3G	342
A-3G(CV)	342
A-4G	342
A-5G	342
AA-1G	343
AA-1G(CV)	343
AA-2G	343
AA-2G(CV)	343
AA-3G	343
AA-3G(CV)	343
AB- 1D	2-160
AB- 1I	2-160
AB- 1T	2

REF.	PAG.
AB- 2D	2-160
AB- 2I	2-160
AB- 2T	2
AB- 3I	2
AB- 3T	2
AB- 4D	160
AB- 4T	2
AB- 5D	3-160
AB- 5I	3-160
AB- 6D	3-160
AB- 6I	3-160
AB- 7I	160
AB- 8D	3-160
AB- 8I	3-160
AB- 9D	3
AB-10I	160
AB-11	3
ABA-1	1
ABC-1	1
ABC-2	1
ABC-3D	1
ABC-5D	1
ABC-5I	1
ABC-6	2
ABC-7	2
ABL-1	2
ABL-2	2
ABL-3	2
ABL-4	2
ABL-5	2
ABL-6	2
ABU- 1	3
ABU- 1D	3
ABU- 2D	3
ABU- 2G	330
ABU- 2I	3
ABU- 3	3
ABU- 4D	3
ABU- 4I	3
ABU- 5D	3
ABU- 6D	3
ABU- 6I	3
ABU- 7D	3
ABU- 8D	3
ABU- 8I	3
ABU- 9D	3
ABU- 9I	3
ABU-10D	3
ABU-10I	3
ABU-11	4
ABU-11D	4
ABU-12D	3
ABU-12I	3
ABU-13	4
ABU-13D	4
ABU-14	3
ABU-15	3
ABU-15D	3
ABU-16	4
ABU-17	4

ÍNDICE GENERAL

GENERAL INDEX

REF.	PAG.	REF.	PAG.	REF.	PAG.	REF.	PAG.	REF.	PAG.
ABU-17D	4	ABU-70	4	ADPLE-55	282	AGA- 1T	7	AGB-2	9
ABU-18DP	4-160	ABU-71D	3	ADS-1D	7	AGA- 2G	330	AGB-3	9
ABU-18P	4-160	ABU-72P	6-160	AEP-1D	7	AGA- 2T	7	AGB-3D	9
ABU-19D	4-160	ABU-73D	6	AEP-2D	7	AGA- 3G	330	AGB-4	9
ABU-19DP	4-160	ABU-74	3	AF- 1D	224	AGA- 3I	7	AGB-5	9
ABU-19P	4-160	ABU-74D	3	AF- 1I	224	AGA- 4D	7	AGD-1	9
ABU-20	3	ABU-75D	6	AF- 2D	224	AGA- 4G	334	AGD-1X	246
ABU-21	4	ABU-76	3	AF- 2I	224	AGA- 4I	7	AGD-2	9
ABU-22D	4	ABU-77	4	AF- 3D	224	AGA- 5D	7	AGD-2X	246
ABU-23D	4	ABU-78	6	AF- 3I	224	AGA- 5G	330	AGE-1I	9
ABU-24D	4	ABU-79	6	AF- 4D	224	AGA- 5I	7	AGE-2D	10
ABU-25D	5	ABU-80	4	AF- 4I	224	AGA- 6D	7	AGU-1D	10
ABU-26D	5	ABU-81	6	AF- 5D	224	AGA- 6G	334	AHR-2	10
ABU-27	5	ABU-83	4	AF- 5I	224	AGA- 6I	7	AHR-3	10
ABU-27D	5	ABU-84D	7	AF- 6D	224	AGA- 7	7	AIZ-1	10
ABU-28	5	ABU-85	4	AF- 6I	224	AGA- 7G	334	AIZ-2D	10
ABU-29P	5	ABU-86D	7	AF- 7D	226	AGA- 8D	8	AKA-1PG	293
ABU-30	5	AC- 9	349	AF- 7I	226	AGA- 8G	334	AKS-1	161
ABU-30D	5	AC-12	349	AF- 7IP	226	AGA- 9G	334	AL-1I	10
ABU-32D	5	AC-14	349	AF- 7IP1	226	AGA- 9I	8	AL-2	10
ABU-34	5	AC-15	349	AF- 8D	226	AGA-10	8	AL-3	10
ABU-35P	5-160	AD- 1	281	AF- 8DP	226	AGA-11	8	ALA-1X	246
ABU-36P	5-160	AD- 2	281	AF- 8I	226	AGA-12	8	ALC-1D	11
ABU-37D	3	AD- 3	281	AF- 8IP	226	AGA-13I	8	ALE-1	10
ABU-38D	5	AD- 4	281	AF- 9D	226	AGA-14D	8	ALE-1D	10
ABU-39P	5	AD- 5	281	AF- 9DP	226	AGA-15	8	ALE-1G	330
ABU-40	5	AD- 6	281	AF- 9I	226	AGA-15G	339	ALF- 1	11
ABU-41	6	AD- 7	281	AF- 9IP	226	AGA-16I	8	ALF- 2	11
ABU-41D	6	AD- 8	281	AF-10	224	AGA-18D	7	ALF- 3	11
ABU-42	6	AD- 9	281	AF-11	224	AGA-18I	7	ALF- 4	11
ABU-42D	6	AD-10	281	AF-12	224	AGA-19D	7	ALF- 5	11
ABU-43D	3	AD-11	281	AF-13	179	AGA-19I	7	ALF- 6	11
ABU-44	3	AD-12	281	AF-13P	179	AGA-20	8	ALF- 7	11
ABU-45	5	AD-13	281	AF-14	179	AGA-22	8	ALF- 8	11
ABU-46	3	AD-16	281	AF-14P	179	AGA-23	8	ALF- 8D	11
ABU-46D	3	AD-17	281	AF-19	224	AGA-23G	339	ALF- 9	11
ABU-47	3	AD-18	281	AF-19P	224	AGA-24D	8	ALF-10	11
ABU-48	4	AD-19	281	AF-21	224	AGA-24I	8	ALF-10D	11
ABU-49	3	AD-20	281	AF-21P	224	AGA-25	8	ALF-11D	11
ABU-50	6	AD-21	281	AG- 1D	10	AGA-27G	339	ALF-12D	11
ABU-51D	6	AD-23	281	AG- 1I	10	AGA-29	8	ALF-13D	11
ABU-52D	3	AD-24	281	AG- 3D	10	AGA-35G	339	ALF-14D	11
ABU-53	3	AD-25	281	AG- 3I	10	AGA-38	8	ALF-15	11
ABU-54	6	AD-26	281	AG- 4D	10	AGA-39	9	ALF-16	11
ABU-54D	6	AD-27	281	AG- 4I	10	AGA-40G	339	ALF-17	11
ABU-55	3	AD-28	281	AG- 5D	10	AGA-42	8	ALF-18	11
ABU-55D	3	AD-29	281	AG- 5I	10	AGA-43	9	ALF-19	11
ABU-57	6	AD-33T	330	AG- 6D	10	AGA-44	9	ALF-20	11
ABU-57D	6	AD-44-1	281	AG- 6I	10	AGA-46G	340	ALF-21	11
ABU-58D	4	AD-44-2	281	AG- 8D	10	AGA-48	8	ALF-22D	11
ABU-60	6	AD-44-3	281	AG- 8I	10	AGA-48G	340	ALF-23	11
ABU-61	6	AD-44-4	281	AG- 9D	10	AGA-49	9	ALF-24	11
ABU-63	6	AD-44-5	281	AG- 9I	10	AGA-49G	340	ALF-25	11
ABU-64P	6-160	AD-44-6	281	AG-10D	10	AGA-50	9	ALF-26	11
ABU-65P	6-160	AD-46	334	AG-10I	10	AGA-50G	340	ALF-27	11
ABU-66	6	AD-47	334	AG-11	10	AGA-51	9	ALF-28	11
ABU-67	3	ADPLE-11	282	AG-11D	10	AGA-52	9	ALF-29	11
ABU-67D	3	ADPLE-22	282	AGA- 1G	283	AGB-1	9	ALF-30	11
ABU-68	6	ADPLE-33	282	AGA- 1I	7	AGB-1D	9	ALF-31	11
ABU-69	3	ADPLE-44	282						

REF.	PAG.	REF.	PAG.	REF.	PAG.	REF.	PAG.	REF.	PAG.
ALF-32D	11	ARC- 1G	330	AS - 7D	15	AS -FM7	16	AS -RH7	16
ALF-33	11	ARC- 2G	330	AS - 8D	15	AS -G5	16	AS -RK7	16
ALF-34	11	ARC- 3G	331	AS - 9D	15	AS -G7	16	AS -RN7	16
ALF-35	11	ARC- 4G	331	AS -10D	15	AS -GG7	16	AS -RR7	16
ALF-36	11	ARC- 5G	331	AS -11D	15	AS -GK5	16	AS -S7	16
ALI-1	37	ARC- 6G	331	AS -12D	15	AS -GK7	16	AS -SS7	16
ALP-1D	11-161	ARC- 7G	331	AS -13D	15	AS -GL5	16	AS -T5	16
ALP-1I	11-161	ARC- 8G	331	AS -14D	15	AS -GL7	16	AS -T7	16
ALP-2	11-161	ARC-10G	331	AS -15D	15	AS -GM5	16	AS -TT7	17
ALP-2D	11-161	ARC-11G	331	AS -16D	15	AS -GM7	16	AS -U5	16
ALP-3	11	ARC-12G	331	AS -17D	161	AS -H7	16	AS -U7	16
ALP-4D	11	ARC-13G	331	AS -18D	15	AS -HH7	17	AS -UU7	17
ALP-5D	11	ARC-14G	331	AS -19D	161	AS -K7	16	AS -V5	16
ALP-6	11-161	ARC-15G	331	AS -20D	15	AS -KA7	17	AS -V7	16
ALP-6D	11-161	ARC-16G	331	AS -21	161	AS -KD7	17	AS -VV7	17
AMA-1	11	ARC-17DP	14	AS -21D	161	AS -KE5	17	AS -W5	16
AMA-1D	11	ARC-17P	14	AS -21DP	161	AS -KE7	17	AS -W7	16
AMB-1	1	ARC-18PG	331	AS -21P	161	AS -KF7	17	AS -WW7	17
AMB-1D	1	ARC-19PG	331	AS -22	15	AS -KG7	17	AS -X7	16
AME -1	12	ARC-20PG	332	AS -23	15	AS -KK7	16	AS -XX7	17
AME -2	12	ARC-21PG	332	AS -23D	15	AS -L7	16	AS -Z7	16
AME -4	12	ARC-22PG	332	AS -24	161	AS -LA7	17	ASH-2	15
AMG- 1	12	ARC-23PG	332	AS -24D	161	AS -LD7	17	ASI-1	15
AMG- 2D	12	ARC-24G	332	AS -25D	15	AS -LE7	17	ASP-1D	15
AMG- 3D	12	ARC-25G	332	AS -28	15	AS -LF7	17	ATA-1	11
AMG- 4D	12	ARC-26G	331	AS -A5	16	AS -LG7	17	ATA-1D	11
AMG- 5D	12	ARC-27PG	332	AS -A7	16	AS -M5	16	ATR-1G	293
AMG- 8D	12	ARE-1D	14	AS -AK5	16	AS -M7	16	ATR-2G	294
AMG- 9D	12	ARFE-1D	14	AS -AK7	16	AS -MA7	17	ATR-2TG	294
AMG-10	12	ARFE-1I	14	AS -AL5	16	AS -MD7	17	AU -1	185
AMG-10D	12	ARFE-3D	14	AS -AL7	16	AS -ME5	17	AU -AH	186
AMM-1	161	ARN-1	14	AS -AM5	16	AS -ME7	17	AU -AHP	186
AMM-2	161	ARN-2	14	AS -AM7	16	AS -MF7	17	AU -AHP1	186
ANA-1	13	ARN-2D	14	AS -B5	16	AS -MG5	17	AU -AN	186
ANA-1D	13	ARN-3	14	AS -B7	16	AS -MG7	17	AU -ANP	186
ANC-1D	12	ARN-3D	14	AS -BK5	16	AS -MM5	16	AU -C	186
ANC-2	13	ARO-1D	14	AS -BK7	16	AS -MM7	16	AU -HV	186
ANK- 1	13	ARR-1	14	AS -BL7	16	AS -N5	16	AU -HVP	186
ANK- 2	13	ARR-2	14	AS -BM7	16	AS -N7	16	AU -HVP1	186
ANK- 3	13	ARR-3	14	AS -D7	16	AS -NN5	16	AU -W	186
ANK- 4	13	ARR-7D	14	AS -DD7	17	AS -NN7	16	AUM-2D	17
ANK- 6	13	ARR-8	14	AS -DK5	16	AS -P5	16	AV-1	17
ANK-17	13	ARR-9D	14	AS -DK7	16	AS -P7	16	AV-1D	17
ANK-47D	13	ARS-1D	15	AS -DL5	16	AS -PA7	17	AV-2D	17
ANK-65	13	AS - 1D	161	AS -DL7	16	AS -PB7	17	AX-1	161
ANT-1G	293	AS - 1G	283	AS -DM5	16	AS -PF7	17	AX-1D	161
ANT-2G	293	AS - 1I	161	AS -DM7	16	AS -PG7	17	AX-1DP	162
ANT-3G	293	AS - 2D	161	AS -E5	16	AS -PH7	17	AX-1P	162
ANT-4G	293	AS - 2G	283	AS -E7	16	AS -PN7	17	AX-2P	162
ANT-5G	293	AS - 2I	161	AS -EK5	16	AS -PP7	16	AX-2P1	162
AP-1D	13	AS - 3D	15	AS -EK7	16	AS -PR7	17	AX-3DP	162
AP-2D	13	AS - 3G	283	AS -EL5	16	AS -PT7	17	AX-4DP	162
AP-3D	13	AS - 3I	15	AS -EL7	16	AS -R7	16	AYP-1G	332
AP-4D	13	AS - 4D	15	AS -EM5	16	AS -RA7	16	AZ- 1D	17
AP-5D	14	AS - 4G	293	AS -EM7	16	AS -RB7	16	AZ- 1I	17
APEC-1G	334	AS - 5D	15	AS -F5	16	AS -RC7	16	AZ- 2D	17
APEC-2G	335	AS - 5G	332	AS -F7	16	AS -RD7	16	AZ- 2I	17
AR-1D	14	AS - 6D	15	AS -FK5	16	AS -RE7	16	AZ- 3D	17
AR-4DP	14	AS - 6G-1	283	AS -FK7	16	AS -RF7	16	AZ- 3I	17
AR-4IP	14	AS - 6G-2	284	AS -FL7	16	AS -RG7	16	AZ- 4	17

ÍNDICE GENERAL

GENERAL INDEX

REF.	PAG.	REF.	PAG.	REF.	PAG.	REF.	PAG.	REF.	PAG.
AZ- 6	17	BCZ-2	20	BK- 9	23	BK-18/20	24	BLU-1X	246
AZ- 7	18	BD-1	18	BK-14	23	BK-18/21	24	BLU-2X	246
AZ- 8D	18	BDA-1	20	BK-16/ 0	23	BK-18/22	24	BM -1P	186
AZ- 9	18	BE- 1	21	BK-16/ 1	23	BK-18/23	24	BM -2	186
AZ- 9D	18	BE- 1G	294	BK-16/ 2	23	BK-18/24	24	BM -2P	187
AZ-10	18	BE- 3G	294	BK-16/ 3	23	BK-18/25	24	BM -3	187
AZ-12	18	BE- 4D	21	BK-16/ 4	23	BK-18/26	24	BM -3P	187
AZ-14	18	BE- 4G	294	BK-16/ 5	23	BK-18/27	24	BM -4	187
AZ-17	18	BE- 4I	21	BK-16/ 7	23	BK-18/28	24	BM -5P	187
AZ-17D	18	BE- 5D	21	BK-16/ 9	23	BK-18/29	24	BM -6P	187
AZ-18	18	BE- 5G	294	BK-16/10	23	BK-18/30	24	BM -6P1C1	187
AZ-18D	18	BE- 5I	21	BK-16/13	23	BK-18/31	24	BM -B	187
AZ-29	18	BE- 6G	294	BK-16/14	23	BK-18/32	24	BM -HB	187
AZ-32	18	BE- 7G	294	BK-16/15	23	BK-18/33	24	BM -HBP	187
AZ-37	18	BE-10G	295	BK-16/16	23	BK-18/34	24	BM -HBP1	187
AZ-37D	18	BES- 1D	21	BK-16/17	23	BK-18/35	24	BM -NB	187
AZKO-1I	18	BES- 2D	21	BK-16/18	23	BK-19/ 1	24	BM -NBP	187
		BES- 3D	21	BK-16/19	23	BK-19/ 2	24	BM -W	187
		BES- 4D	21	BK-16/20	23	BK-19/ 4	24	BMB-1	24
		BES- 5D	21	BK-16/21	23	BK-19/ 5	24	BMB-2	24
		BES- 6D	21	BK-16/23	23	BK-19/ 6	24	BMB-3D	24
		BES- 7D	21	BK-16/30	23	BK-19/ 7	24	BMC-1G	295
		BES- 8D	21	BK-17/1	23	BK-19/ 8	24	BOB-1D	163
		BES- 9D	21	BK-17/1PZ	23	BK-19/10	24	BOD-1	24
		BES-10D	21	BK-17/2	23	BK-19/11	24	BOD-1G	295
		BES-11D	21	BK-17/2PZ	23	BK-19/12	24	BOD-2G	295
		BES-12D	21	BK-17/3	23	BK-19/13	24	BOD-3G	295
		BES-13D	21	BK-17/4	23	BK-19/14	24	BOD-4G	284
		BES-14D	21	BK-17/4PZ	23	BK-19/15	24	BOD-5G	284
		BES-15D	21	BK-17/5	23	BK-19/16	24	BOG-1G	295
		BES-16D	21	BK-17/5PZ	23	BK-19/19	24	BOG-2G	295
		BES-17D	21	BK-17/6	23	BK-19/20	24	BOM-1	25
		BEY-1D	21	BK-17/6PZ	23	BK-19/21	24	BOM-1D	25
		BEY-2D	21	BK-17/7	23	BK-19/23	24	BOM-2	25-163
		BH-1	163	BK-17/7PZ	23	BK-19/25	24	BOM-2D	25-163
		BH-1P	163	BK-17/8	23	BK-19/26	24	BON-3G	262
		BH-2	163	BK-17/8PZ	23	BK-19/27	24	BOX-1G	295
		BH-3	163	BK-17/9	23	BK-19/31	24	BRA-1	99
		BH-4	163	BK-17/9PZ	23	BK-19/32	24	BRA-2	25-163
		BH-5	163	BK-17D/1PZ	23	BK-20	24	BRAS -1	25
		BH-6	163	BK-17D/2PZ	23	BK-21/ 1	22	BRI- 1D	25
		BH-8	163	BK-17D/3PZ	23	BK-21/ 2	22	BRI- 1I	25
		BI-1D	21	BK-17D/4PZ	23	BK-21/ 7	22	BRI- 1X	246
		BI-2	22	BK-18/ 1	24	BK-21/ 9	22	BRI- 2D	25
		BI-3D	22	BK-18/ 2	24	BK-21/14	22	BRI- 2I	25
		BIE-1	22	BK-18/ 3	24	BK-21/17	22	BRI- 2X	246
		BIF-1	22	BK-18/ 4	24	BK-21/19	22	BRI- 3D	25
		BIL-1T	22	BK-18/ 5	24	BKY-1	25	BRI- 3I	25
		BK- 1D	22	BK-18/ 6	24	BKY-2	25	BRI- 3X	246
		BK- 1I	22	BK-18/ 7	24	BL-1D	162	BRI- 4D	25
		BK- 2D	22	BK-18/ 9	24	BL-1I	162	BRI- 4I	25
		BK- 3D	22	BK-18/10	24	BL-2	162	BRI- 6D	25
		BK- 4	22	BK-18/11	24	BL-3	162	BRI- 6I	25
		BK- 4D	22	BK-18/12	24	BL-4	162	BRI- 6L 1	284
		BK- 5D	22	BK-18/13	24	BL-4D	162	BRI- 6L 2	284
		BK- 5I	22	BK-18/14	24	BL-5	162	BRI- 6L 7	284
		BK- 6D	22	BK-18/15	24	BL-5D	162	BRI- 6L 8	284
		BK- 6I	22	BK-18/16	24	BL-6	162	BRI- 6L11	284
		BK- 7D	22	BK-18/17	24	BL-6D	162	BRI- 6L12	284
		BK- 8D	23	BK-18/18	24	BLT-1	20	BRI- 6L17	284

REF.	PAG.	REF.	PAG.	REF.	PAG.	REF.	PAG.	REF.	PAG.
BRI- 6L18	284	BTV-2I	27	BUR-33	30	CE- 12D	33	CE- 70	34
BRI- 6L21	284	BTV-3	27	BUR-34	30	CE- 13D	33	CE- 71	34
BRI- 6L22	284	BU-1D	30	BUS-1	30	CE- 14D	33	CE- 72	34
BRI- 6L29	284	BU-1I	30	C		CE- 15D	33	CE- 73	34
BRI- 6L30	284	BUL-1	27	C	30	CE- 16D	33	CE- 74	34
BRI- 7D	25	BUL-2D	27	C-2	31	CE- 17D	33	CE- 75	34
BRI- 8I	25	BUL-3D	27	C-3G	343	CE- 18D	33	CE- 76	34
BRI- 9D	25	BUL-4D	27	C-3G(CV)	343	CE- 19D	33	CE- 77	34
BRI-10	26	BUL-5D	28	CA- 1I	31	CE- 20D	33	CE- 78	34
BRI-12	26	BUL-6D	27	CA- 2I	31	CE- 21D	33	CE- 79	34
BRI-13	25	BUL-7D	28	CA- 3I	31	CE- 22D	33	CE- 80	34
BRI-14	25	BUR- 1D	28	CA- 4D	31	CE- 23D	33	CE- 81	34
BRI-14D	25	BUR- 1G	335	CA- 4I	31	CE- 24D	33	CE- 82	34
BRI-15	25	BUR- 1I	28	CA- 5I	31	CE- 25D	33	CE- 83	34
BRI-16	26	BUR- 1X	246	CA- 6D	31	CE- 26D	33	CE- 84	34
BRI-17	25	BUR- 2D	28	CA- 7	32	CE- 27D	33	CE- 85	34
BRI-18	26	BUR- 2I	28	CA- 7D	32	CE- 28D	33	CE- 86	34
BRI-18D	26	BUR- 2X	247	CA- 8D	32	CE- 29D	33	CE- 87	34
BRI-19	26	BUR- 3	28	CA- 8I	32	CE- 30D	33	CE- 88	34
BRI-20	25	BUR- 3D	28	CA- 9I	31	CE- 31D	33	CE- 89	34
BRI-21	25	BUR- 3X	247	CA-10I	31	CE- 32D	33	CE- 89D	34
BRI-22	26	BUR- 4	28	CA-11I	31	CE- 33D	33	CE- 90D	34
BRI-23	26	BUR- 4D	28	CA-12I	31	CE- 34D	33	CE- 92	33
BRI-24	26	BUR- 4X	247	CA-13D	31	CE- 35D	33	CE- 92D	33
BRI-25	26	BUR- 5	28	CA-14D	32	CE- 36D	33	CE- 93D	33
BRI-26	26	BUR- 5D	28	CA-14D	32	CE- 37D	33	CE- 94	34
BRI-27	26	BUR- 5X	247	CA-15I	32	CE- 38D	33	CE- 96	34
BRI-28	26	BUR- 6	28-164	CAB-1D	30	CE- 39D	33	CE- 97	34
BRI-29	26	BUR- 7	28	CAF-1G	296	CE- 40D	33	CE- 98D	35
BRI-30	26	BUR- 8D	28	CAF-2G	296	CE- 41D	33	CE- 99D	33
BRI-31	26	BUR- 9	28	CAM-1D	164	CE- 42D	33	CE-100D	33
BRI-32D	26	BUR- 9D	28	CAS -1D	164	CE- 43D	33	CE-101D	33
BRI-33	26	BUR-10	28	CAT-1P	164	CE- 44D	33	CE-102	35
BRI-34	26	BUR-10D	28	CAT-2	164	CE- 45D	33	CE-103	35
BRR-1	20	BUR-11D	29	CAT-3	164	CE- 46D	33	CE-104D	35
BRS-1	25	BUR-12	29	CAY-1D	32	CE- 47D	33	CE-105	35
BRU -1	26	BUR-13D	29	CAY-1I	32	CE- 48D	33	CE-106	35
BRU -1D	26	BUR-14	29	CAY-2	32	CE- 49	34	CE-107	35
BS-1I	163	BUR-14D	29	CCF- 1X	247	CE- 49D	34	CE-108	33
BS-2	164	BUR-15	29	CCF- 5X	247	CE- 50	34	CE-109D	35
BS-4D	164	BUR-16	29	CCF- 8X	247	CE- 51	34	CE-110	33
BS-5	164	BUR-17	29	CCF- 9X	247	CE- 51D	34	CE-111D	35
BS-6	164	BUR-17D	29	CCF-10X	248	CE- 52	34	CE-114	35
BS-7	164	BUR-18D	29	CE- 1D	33	CE- 53D	34	CE-117D	35
BS-7D	164	BUR-19D	29	CE- 1I	33	CE- 54	34	CE-118D	33
BS-8	164	BUR-20D	29	CE- 2D	33	CE- 55	34	CE-130	35
BS-8D	164	BUR-21D	29	CE- 2I	33	CE- 56	34	CE-131D	35
BS-9	164	BUR-22D	29	CE- 3D	33	CE- 57	34	CE-132/15	35
BS-9D	164	BUR-23D	29	CE- 3I	33	CE- 58	34	CE-132/16	35
BSS-1D	26	BUR-24	29	CE- 4D	33	CE- 59	34	CE-132/17	35
BSS-2	26	BUR-24D	29	CE- 5	33	CE- 60	34	CE-132/18	35
BSS-2D	26	BUR-25D	29	CE- 5D	33	CE- 61	34	CE-132/25	35
BSS-3	27	BUR-26D	30	CE- 6D	33	CE- 62	34	CE-132/26	35
BSS-4D	27	BUR-27D	28	CE- 6I	33	CE- 63	34	CE-132/27	35
BSS-5D	27	BUR-28	30	CE- 7D	33	CE- 64	34	CE-132/35	35
BSS-6D	27	BUR-29	30	CE- 7I	33	CE- 65	34	CE-132/36	35
BSS-7D	27	BUR-29D	30	CE- 8D	33	CE- 66	34	CE-132/37	35
BTV-1D	27	BUR-30D	164	CE- 9D	33	CE- 67	34	CE-132/38	35
BTV-1I	27	BUR-31D	30	CE- 10D	33	CE- 68	34	CE-132/45	35
BTV-2D	27	BUR-32D	30	CE- 11D	33	CE- 69	34	CE-132/46	35

ÍNDICE GENERAL

GENERAL INDEX

REF.	PAG.	REF.	PAG.	REF.	PAG.	REF.	PAG.	REF.	PAG.
CE-134	35	CHU - 1G	284	CI -32	38	CIS-1D	31	COR- 7	41
CE-135D	35	CHU - 2G	284	CI -33	38	CIS-1I	31	COR- 8	41
CEM-BP	164	CHU - 4G	297	CI -34	39	CIS-2	31	COR- 9	41
CEM-JC	165	CHU - 5G	297	CI -34D	39	CIS-3	31	COR- 10	41
CENT-1D	32	CHU -10	36	CI -35	38	CIS-4	31	COR- 11	41
CENT-1I	32	CI - 1D	37	CI -36	39	CIS-5	31	COR- 11D	41
CENT-2D	32	CI - 1G	298	CI -38D	39	CIS-6D	31	COR- 12	41
CENT-2I	32	CI - 1I	37	CI -39D	37	CIS-7D	31	COR- 13	41
CENT-3D	32	CI - 1PG	298	CI -3PG	298	CIS-803-1	340	COR- 13D	41
CENT-4	32	CI - 2	39	CI -41	39	CIS-803-2	340	COR- 15D	41
CER-1	32	CI - 2G	298	CI -42	39	CIS-803-3	340	COR- 16D	41
CER-1G	314	CI - 2I	39	CI -43D	39	CIS-803-4	340	COR- 17D	41
CER-2G	314	CI - 3D	37	CI -44D	38	CIS-803-5	340	COR- 18D	41
CER-3G	314	CI - 3G	298	CI -45D	39	CIS-803-6	340	COR- 19D	41
CER-4G	314	CI - 4D	37	CI -46D	39	CL-1I	40-166	COR- 20	41
CF-1D	36	CI - 4DP	37	CI -48	39	CL-2D	166	COR- 20-25	42
CF-1I	36	CI - 4G	298	CI -49	39	CL-2I	166	COR- 20D	41
CHA-2	36	CI - 4I	37	CI -51	39	CL-3I	167	COR- 21D	41
CHA-2D	36	CI - 4IP	37	CI -51D	39	CL-4I	167	COR- 22D	41
CHEK-1	36	CI - 5DP	38	CI -53	39	CL-5D	167	COR- 23D	42
CHI- 1	36	CI - 5IP	38	CI -55D	39	CL-6	167	COR- 24	42
CHI- 1T	36	CI - 5PG	298	CI -56	38	CL-6P	167	COR- 24D	42
CHI- 2	36	CI - 6D	38	CI -57	39	CL-7P	167	COR- 25	42
CHI- 3	36	CI - 6G	298	CI -58D	38	CL-8P	167	COR- 25I	42
CHI- 4	36	CI - 6I	38	CI -59	38	CL-9P	167	COR- 26	42
CHI- 5	36	CI - 6PG	299	CI -60	38	CLA-3G	299	COR- 27D	42
CHI- 6	36	CI - 7D	38	CI -61	39	CLF-1	40	COR- 28	42
CHI- 7D	36	CI - 7TG	299	CI -62	39	CLI-1D	167	COR- 29D	42
CHI- 8D	36	CI - 8D	39	CI -62D	39	CLK-1	44	COR- 30	42
CHI- 9D	36	CI - 8G	299	CI -63	39	CLS-1D	40	COR- 31	42
CHI-10D	36	CI - 9D	39	CI -63D	39	CLU-1D	167	COR- 32	42
CHI-12D	36	CI - 9PG	299	CI -64D	39	CLU-1I	167	COR- 33	42
CHR- 1	165	CI -10D	39	CI -65	39	CLU-2	167	COR- 34	42
CHR- 2	165	CI -10G	298	CI -66D	39	CLU-3	167	COR- 35	43
CHR- 3	165	CI -11D	39	CI -67	38	CLU-4	167	COR- 36D	41
CHR- 3P	165	CI -12	39	CI -69	39	CLU-5	167	COR- 37	43
CHR- 4D	222	CI -12TG	299	CI -70	39	CMA-1	32	COR- 40	43
CHR- 4I	222	CI -13	39	CI -71	39	CMA-1D	32	COR- 48	41
CHR- 5	165	CI -13G	299	CI -72	39	CMA-2	32	COR- 49	41
CHR- 6	165	CI -14	38	CI -73	39	CMA-2D	32	COR- 50-60	43
CHR- 6D	165	CI -14G	299	CI -DL	39	CML-1	30	COR- 50-60I	43
CHR- 7	165	CI -15	39	CI -IL	39	CN-1D	165	COR- 62	43
CHR- 7P	165	CI -15D	39	CIE-1D	36	CO -1D	43	COR- 64	41
CHR- 8	165	CI -16D	39	CIF-1D	37	CO -M	44	COR- 65	41
CHR- 8P	165	CI -17	38	CIF-1X	248	COB-1	167	COR- 66	41
CHR- 9	165	CI -18	39	CIF-2D	37	COB-1P	168	COR- 67	41
CHR- 9P	165	CI -19D	38	CIF-3	37	COB-2	168	COR- 68	41
CHR-10	166	CI -20	38	CIF-3D	37	COH-1	40	COR- 69	41
CHR-10P	166	CI -20D	38	CIF-4	37	COH-2	40	COR- 70D	43
CHR-11	166	CI -21	38	CIL-1	37	COH-2D	40	COR- 71	41
CHR-11P	166	CI -22D	38	CIL-1D	37	COH-3	40	COR- 72	41
CHR-12	166	CI -23D	38	CIL-2D	37	COH-4	40	COR- 73	41
CHR-13D	166	CI -24	38	CIL-3D	37	COM-1D	40	COR- 74	41
CHR-14	166	CI -25	38	CIL-4	37	COR- 1D	41	COR- 76D	41
CHR-14P	166	CI -26	38	CIL-4D	37	COR- 1GD	41	COR- 77	43
CHR-15	166	CI -27	39	CIL-5D	37	COR- 1I	41	COR- 78	43
CHR-15P	166	CI -28D	38	CIN-1	37	COR- 2D	41	COR- 79	41
CHR-17	166	CI -29	39	CIN-1D	37	COR- 2I	41	COR- 80	41
CHTZ-1	36	CI -30	38	CIN-2	37	COR- 3	41	COR-114	43
CHU - 1D	36	CI -31	38	CIN-2D	37	COR- 3D	41	COR-115D	43

REF.	PAG.	REF.	PAG.	REF.	PAG.	REF.	PAG.	REF.	PAG.
COR-153	43	DAC-1DP	168	DAT- 9D	219	DMR-6-2	285	DOM-27/16	48
COR-223	43	DAC-2D	168	DAT- 9DP	219	DMR-6-2L	285	DOM-27/19	48
COT-1D	44	DAC-3DC1	168	DAT- 9I	219	DMR-6-3	285	DOM-27/35	48
CR- 1G	300	DAC-4DC1	168	DAT- 9IP	219	DMR-6-3L	285	DOM-27D/ 1	49
CR- 2G	300	DAC-5C1	168	DAT-10	219	DMR-6-4	285	DOM-27D/ 2	49
CR- 3G	300	DAD-1D	44	DAT-10P	220	DMR-6-4L	285	DOM-27D/ 3	49
CR- 4G	300	DAD-1I	44	DAT-11	220	DMR-7-1	285	DOM-27D/ 4	49
CR- 5G	300	DAD-2D	44	DAT-11D	220	DMR-7-2	285	DOM-27D/ 5	49
CR- 8G	300	DAD-2I	44	DAT-11DP	220	DMR-7-3	285	DOM-27D/ 6	49
CR-10G	300	DAD-3D	44	DAT-11P	220	DMR-7-4	285	DOM-27D/ 7	49
CR-11G	301	DAD-4D	44	DAT-12	220	DO-2I	51	DOM-27D/ 8	49
CR-12G	301	DAD-5D	44	DAT-13	220	DO-3	51	DOM-27D/ 9	49
CR-14G	301	DAD-6D	44	DAT-13P	220	DO-4	51	DOM-27D/10	49
CR-17TG	301	DAE-1P	168	DAT-14	220	DO-5	52	DOM-27D/11	49
CR-18G	301	DAE-2DP	168	DAT-14P	220	DO-5D	52	DOM-27D/12	49
CR-19G	301	DAE-3D	168	DAT-15	220	DO-7	52	DOM-27D/13	49
CRC-1X	248	DAE-3DP1	168	DAT-15C1	220	DOB-1	169	DOM-27D/14	49
CRN-1G	300	DAE-3DP2	169	DAT-15C2	220	DOB-1D	169	DOM-27D/15	49
CRO-1G	335	DAE-3P2	169	DAT-15P	220	DOB-2	169	DOM-27D/16	49
CRT- 1G	296	DAE-4D	168	DAT-16	220	DOB-2D	169	DOM-27D/17	49
CRT- 2G	296	DAE-4DP1	168	DAT-17	220	DOB-3	169	DOM-27D/18	49
CRT- 3G	296	DAE-4P1	168	DAT-17D	220	DOB-3D	169	DOM-27D/19	49
CRT- 4G	296	DAE-5P	169	DAT-18	221	DOI-1	51	DOM-27D/20	49
CRT- 7G	296	DAF-1	45	DAT-19	221	DOI-4	51	DOM-27D/21	49
CRT- 8G	296	DAF-1D	45	DAT-19P	221	DOL-1X	248	DOM-27D/22	49
CRT-10G	332	DAF-2	45	DAT-20	221	DOM- 1D	46	DOM-27D/23	49
CRT-11G	297	DAF-3D	45	DAT-20P	221	DOM- 1DP	47	DOM-27D/24	49
CRT-12G	297	DAF-4D	45	DAV-1	169	DOM- 1I	46	DOM-27D/25	49
CRT-13G	297	DAI-1P	169	DAV-1P	169	DOM- 2D	47	DOM-27D/26	49
CRT-14G	297	DAI-2D	169	DC-1D	52	DOM- 3D	47	DOM-27D/27	49
CRT-15G	297	DAL-1P	168	DC-2D	52	DOM- 3I	47	DOM-27D/28	49
CRT-17G	297	DAR-1	169	DC-3	52	DOM- 4	47	DOM-27D/29	49
CRT-18G	297	DAT- 1D	218	DC-4D	52	DOM- 4D	47	DOM-27D/30	49
CSB-1D	31	DAT- 1DP	218	DEB- 1X	248	DOM- 5D	47	DOM-27D/31	49
CSB-2D	31	DAT- 1I	218	DEB-12L	285	DOM- 6D	47	DOM-27D/32	49
CT-1	224	DAT- 1IP	218	DEF-1D	45	DOM- 6I	47	DOM-27D/33	49
CT-1P	224	DAT- 2D	218	DEK- 1G	302	DOM- 7D	47	DOM-27D/34	49
CT-2	224	DAT- 2DP	218	DEK- 2	45	DOM- 7I	47	DOM-27D/35	49
CT-2P	225	DAT- 2I	218	DEK- 3	45	DOM- 8D	47	DOM-27D/36	49
CT-2P1	225	DAT- 2IP	218	DEK- 4	45	DOM- 9	47-169	DOM-27D/37	49
CT-3	225	DAT- 3D	218	DEK- 6D	45	DOM- 9D	47-169	DOM-27D/38	49
CT-3P	225	DAT- 3I	218	DEK- 7D	45	DOM-10D	47	DOM-27D/39	49
CT-4P	225	DAT- 4D	218	DEK- 8	45	DOM-11D	47	DOM-27D/40	49
CUB-1	44	DAT- 4I	218	DEK- 9D	45	DOM-11I	47	DOM-27D/41	49
CVL-1D	44	DAT- 5D	218	DEK-10	45	DOM-12	47	DOM-27D/42	49
CVL-1I	44	DAT- 6	218	DEK-11	45	DOM-12D	47	DOM-27D/43	49
CVL-2D	44	DAT- 6C1	219	DEK-13	45	DOM-13D	47	DOM-27D/44	49
CVL-2I	44	DAT- 6D	218	DEK-14D	45	DOM-14D	47-170	DOM-27D/45	49
CVL-3D	44	DAT- 6DP	219	DIA-1	46	DOM-15D	48	DOM-27D/46	49
CVL-3I	44	DAT- 6DP1	219	DIA-2	46	DOM-16D	48	DOM-27D/47	49
CVL-4	44	DAT- 6P	219	DIA-3	46	DOM-17I	48	DOM-27D/48	49
CVL-5D	44	DAT- 6P1	219	DIE-1	46-349	DOM-18D	48	DOM-27D/49	49
CVL-5I	44	DAT- 7	218	DLC-1	46	DOM-20D	48	DOM-27D/50	49
CVL-6	44	DAT- 7P	219	DLC-2	46	DOM-21D	48	DOM-27D/51	49
CVL-8D	44	DAT- 7P1	219	DLC-3	46	DOM-22	48	DOM-27D/52	49
CVL-9D	44	DAT- 8	219	DLP-1	45	DOM-25D	48	DOM-27D/53	49
		DAT- 8I	219	DLP-2	46	DOM-26	48	DOM-27D/54	49
		DAT- 8IP	219	DM-1	46	DOM-26D	48	DOM-27D/55	49
		DAT- 8IP1	219	DMR-6-1	285	DOM-27/12	48	DOM-27D/56	49
		DAT- 8P	219	DMR-6-1L	285	DOM-27/13	48	DOM-27D/57	49

D

ÍNDICE GENERAL

GENERAL INDEX

REF.	PAG.	REF.	PAG.	REF.	PAG.	REF.	PAG.	REF.	PAG.	
DOM-27D/58	49	DV- 3G	302	ELZ-11D	53	EV- 3D	55	F		
DOM-27D/59	49	DV- 4G	335	ELZ-12	53	EV- 3I	55		F1(L)	347
DOM-27D/60	49	DV- 5G	302	ELZ-12D	53	EV- 4D	55		FA-1	59
DOM-27D/61	49	DV- 6G	302	EMK-1	53	EV- 6D	56		FA-1D	59
DOM-28	49	DV- 7G	302	EP-1D	53	EV- 7D	56		FA-1G	286
DOM-28D	49	DV- 8G	302	ER-1D	53	EV- 8D	56		FA-2G	286
DOM-29	49	DV- 9G	302	ER-1G	286	EV- 9D	56		FA-2PPG	286
DOM-30	49	DV-10G	303	ER-2D	53	EV-10	55		FA-3G	287
DOM-31	49	DV-10G-A	335	ER-3	54	EV-11	56		FA-3PPG	287
DOM-32	50	DV-11G	335	ER-4D	54	EV-11D	56		FA-4G	287
DOM-33	50	DV-12G	303	ER-4G	286	EV-12D	56		FA-5G	287
DOM-34	50	DV-13G	303	ER-5G	286	EV-13D	55		FA-6G	287
DOM-35	50	DV-13G-A	336	ERV-1G	304	EV-19	56		FA-7G	287
DOM-35D	50	DV-14G	303	ERV-2G	304	EV-20D	56		FAB-1	170
DOM-36	50	DV-15G	303	ERV-3G	304	EV-23D	56		FAB-2	170
DOM-36D	50	DV-16G	303	ERV-3G-A	336	EV-24	56	FAC- 1D	58	
DOM-37	50	DV-17G	336	ES-1D	54	EV-25D	55	FAC- 1G	307	
DOM-37D	50	DV-18G	303	ES-1G	286	EV-27D/ 1	56	FAC- 1I	58	
DOM-38D	50-170	DV-19G	303	ES-1I	54	EV-27D/ 2	56	FAC- 2D	58	
DOM-39	50	DX-5	46	ESL-1	54	EV-27D/ 3	56	FAC- 2G	307	
DOM-40D	50	DX-5D	46	ESL-1D	54	EV-27D/ 4	56	FAC- 2I	58	
DOM-41D	48	DX-6	46	ESS-1	54	EV-27D/ 5	56	FAC- 3D	58	
DOM-42	50	DX-6D	46	ESS-2	54	EV-27D/ 6	56	FAC- 3G	307	
DOM-43	50			ESS-3	54	EV-27D/ 7	56	FAC- 3I	58	
DOM-44D	48	E		ESS-4	54	EV-27D/ 8	56	FAC- 4D	58	
DOM-45	48	E-0G	343	ESS-9D	54	EV-27D/ 9	56	FAC- 4G	307	
DOM-46D	48	E-0G(CV)	343	EST- 1G	304	EV-27D/10	56	FAC- 5D	58	
DOM-48	47	E-1G	343	EST- 2G	304	EVE-1	55	FAC- 6D	58	
DOM-49D	48	E-1G(CV)	343	EST- 3G	305	EVE-1D	55	FAC- 7D	58	
DOM-51	50	E-2G	344	EST- 4G	305	EVE-2D	55	FAC- 8D	58	
DOM-52	50	E-2G(CV)	344	EST- 5G	305	EVE-3D	55	FAC- 9D	58	
DOM-53D	50	E-3G	344	EST- 5TG	305	EVE-4	55	FAC-10D	58	
DOM-54D	50	E-3G(CV)	344	EST- 6G	305	EX-1D	56	FAC-11D	58	
DOM-55	51	EAG-2D	52	EST- 7G	305	EXS-1D	56	FAC-12D	58	
DOM-55D	51	EC-1	52	EST-10G	305	EXS-2D	56	FAC-13D	58	
DOM-56D	51	EC-1D	52	ETS-1D	54	EXS-3	56	FAC-14D	58	
DOM-57	51	ECH-1	170	EU- 1	54	EXS-3D	56	FAC-15	58	
DOM-57D	51	EG-1	52	EU- 2	55	EXS-4D	56	FAC-18	58	
DOM-58D	50	EG-2	52	EU- 3	55	EXS-5	56	FAC-19	58	
DOM-59	51	EI-1D	52	EU- 4	55	EXS-5D	56	FAC-20D	58	
DOM-60D	51	EI-2D	52	EU- 4D	55	EXS-6	56	FAC-21	59	
DOM-61	51	ELB-1G	303	EU- 6	54	EZ-1D	56	FAC-21D	59	
DOM-62D	51	ELZ- 1D	53	EU- 7	55	EZ-1G	306	FAC-22D	59	
DOM-63D	51	ELZ- 1G	304	EU- 7D	55	EZ-1I	56	FAC-23	59	
DOM-64D	51	ELZ- 2	53	EU- 8D	55	EZ-2G	306	FAC-24	59	
DOM-65	51	ELZ- 2G	285	EU- 9	54	EZ-2I	56	FAI-A	171	
DOM-66D	51	ELZ- 3D	53	EU-10D	54	EZ-3D	57	FAI-B	171	
DOM-67D	51	ELZ- 3G	285	EU-11	55	EZ-3G	306	FAI-C	171	
DOM-68	51	ELZ- 4	53	EU-12	55-170	EZ-3I	57	FAI-D	171	
DOM-71D	51	ELZ- 4D	53	EU-13D	55	EZ-4D	57	FAIN-1I	59	
DOM-72D	50	ELZ- 4G	304	EU-14D	54	EZ-4G	306	FAL-1D	59	
DOM-73D	51	ELZ- 5D	53	EUB-1	54	EZ-4I	57	FAL-2D	59	
DOM-74D	50	ELZ- 5G	286	EUB-2	54	EZ-5G	306	FAM-1	59	
DOM-B1	51	ELZ- 6D	53	EUR-1D	54	EZ-6G	306	FAM-2	59	
DR-1	46	ELZ- 6G	286	EUT-1G	305	EZ-7G	306	FAN-1	59	
DU-1	170	ELZ- 7G	304	EUT-2G	306	EZ-8G	307	FAN-1D	59	
DUP-1G	335	ELZ- 8D	53	EUT-3G	306	EZ-DS10	57	FAR-1D	171	
DUR-1D	52	ELZ- 9	53	EV- 1	55	EZ-DS10E	57	FAR-1I	171	
DV- 1G	302	ELZ-10	53	EV- 2	55	EZ-DS15	57	FAR-2D	171	
DV- 2G	335	ELZ-10D	53	EV- 2I	55	EZ-DS15R	57			

REF.	PAG.	REF.	PAG.	REF.	PAG.	REF.	PAG.	REF.	PAG.
FAR-2I	171	FEM-3D	171	FI-16P1	234	FO -20D	173	FTH- 9	63
FAR-3	171	FEM-3I	171	FIA-1	171	FO -22P	173	FTH-10	63
FAR-3D	171	FER-1	60	FIA-2	171	FO -24C1	187	FTH-11D	63
FAR-4D	171	FET-1G	307	FIC- 1	61	FO -24C2	188	FTH-12D	64
FAS-1	59	FF- 1	60	FIC- 2	61	FO -35	173	FTH-13D	64
FAV-1D	59	FF- 1D	60	FIC- 5	61	FO -36	174	FTH-14D	64
FAV-2	59	FF- 2	60	FIC- 7	61	FO -ANP	174	FTH-15	64
FAY-1D	60	FF- 2D	60	FIC- 8	61	FO -D	174	FTH-16	64
FAY-1X	248	FF- 3	60	FIC- 9	61	FO -E-TC	174	FTH-17D	64
FB- 1	57	FF- 5D	60	FIC- 18	61	FO -E-TCP	174	FTH-18	64
FB- 2D	57	FF- 6	61	FIC-200	310	FO -FHP	174	FTH-19	64
FB- 2I	57	FF- 7D	61	FIC-401G	287	FO -FK	174	FTH-20D	64
FB- 3	57	FF- 8D	61	FIS-1D	62-171	FO -FKP	174	FTH-21	63
FB- 4	57	FF- 9D	61	FLO-1	62	FO -FR	174	FTH-22	63
FB- 5	57	FF-10D	60	FLO-1D	62	FO -FRP	174	FTH-23	64
FB- 6	57	FF-11	61	FLO-2D	171	FO -OA	174	FTH-25	64
FB- 7	57	FF-13	61	FM- 1G	308	FO -OL	174	FTH-26D	64
FB- 8	57	FI- 1	179	FM- 1X	248	FO -OR	174	FTH-27	65
FB- 9	57	FI- 1P	179	FM- 2G	308	FO -PN	174	FTH-28	65
FB-10	57	FI- 1P8	179	FM- 2X	248	FO -PRL	174	FTH-29	65
FB-11	57	FI- 2D	179	FM- 3G	308	FO -PRR	174	FTH-31	65
FB-12	57	FI- 2DP3	179	FM- 4G	308	FO -SR	188	FV-1D	60
FB-13	57	FI- 3	179	FM- 4TG	308	FO -TC	174		
FB-14	57	FI- 3D	179	FM- 5G	308	FO -TX	175		
FB-15	57	FI- 3DP	179	FM- 6G	308	FO -TX1	175	G	
FB-16	57	FI- 3DP1	179	FM- 7G	308	FO -TX1P	175	GAB-1D	65
FB-17	57	FI- 3DP2	179	FM- 8G	309	FO -TX2	175	GAB-1I	65
FB-18	57	FI- 3DP3	179	FM-13G	309	FO -TX2P	175	GAB-2	65
FB-19	57	FI- 3DP4	180	FM-14G	309	FO -TXP	175	GARD-1G	310
FB-20	57	FI- 3DP5	180	FM-15G	309	FO -XL	174	GAS -1	175
FB-21	57	FI- 4D	180	FM-16G	309	FO -XR	174	GAS -1D	175
FB-22	57	FI- 5D	180	FM-17G	309	FON-1E	62	GAT-1	65
FB-23	57	FI- 5I	180	FM-20G	309	FON-2E	62	GAT-2D	65
FB-24	57	FI- 6I	180	FM-21G	309	FON-3E	62	GAT-3D	65
FB-25	57	FI- 6IP	180	FO - 1	171	FON-4E	62	GBZ-1	65
FB-26	57	FI- 6IP1	180	FO - 2	172	FON-5E	62	GDA- 1P	67
FB-27	57	FI- 6IP2	180	FO - 3	171	FON-6E	62	GDA- 3D	67
FB-28	57	FI- 6IP3	180	FO - 3D	171	FON-6E	62	GDA-30D	67
FB-29	57	FI- 6IP4	179	FO - 3DP	172	FORTIS-2I	63	GDA-50D	67
FB-31	57	FI- 7I	180	FO - 3P	172	FR- 1D	62	GDA-60D	67
FB-32	57	FI- 8I	180	FO - 4P	172	FR- 2	62	GE- 1D	65
FB-33	57	FI- 8IP	180	FO - 5	165	FR- 4	62	GE- 2	65
FB-34	57	FI- 8IP1	180	FO - 6P	172	FR- 7D	62	GE- 3D	66
FB-35	57	FI- 9I	181	FO - 7P	172	FR- 8	62	GE- 4D	66
FB-38	57	FI- 9IP	181	FO - 8	172	FR- 9D	62	GE- 5	66
FB-39	57	FI-10	179	FO - 8D	172	FR-11D	62	GE- 5D	66
FB-41	57	FI-10P	179	FO - 8DP	172	FRI-1X	249	GE- 6	66
FCS-1D	61	FI-11	181	FO - 8DP1	172	FRI-2X	249	GE- 6D	66
FEB-1G	307	FI-11P	181	FO - 9D	172	FRI-3	63	GE- 7	66
FEB-2G	307	FI-12	179	FO - 9DP	172	FTE -1	62	GE- 8	66
FEC-1D	60	FI-12P	179	FO - 10P	172	FTE -1D	62	GE- 9	66
FEC-2	60	FI-12P1	179	FO -10D	172	FTH- 1	63	GE-10D	66
FEC-3D	60	FI-12P3	179	FO -11D	172	FTH- 1D	63	GE-11	66
FED-1	60	FI-13	181	FO -12	173	FTH- 2	63	GE-15D	66
FED-2	60	FI-13P	181	FO -12P	173	FTH- 3	63	GE-16D	66
FED-3	60	FI-13P1	181	FO -13DP	173	FTH- 4	63	GE-19	66
FEM-1D	171	FI-13P7	181	FO -14DP	173	FTH- 5	63	GE-21	66
FEM-1I	171	FI-14P	181	FO -15D	173	FTH- 6	63	GE-21D	66
FEM-2D	171	FI-15	181	FO -15DP	173	FTH- 7	63	GEA-1	66
FEM-2I	171	FI-16C1	234	FO -17P	173	FTH- 8	63	GEA-1X	249
				FO -18D	173	FTH- 8D	63	GEA-2D	66

ÍNDICE GENERAL

GENERAL INDEX

REF.	PAG.	REF.	PAG.	REF.	PAG.	REF.	PAG.	REF.	PAG.
GEA-3	66	GM - 4P1	176	GMT-3D	65	HAW-1D	71	HOND-16DP1	184
GEA-3X	249	GM - 5	176	GMT-4D	65	HAW-2D	71	HOND-17P	184
GEA-4D	67	GM - 5P	176	GMT-5D	65	HAW-3D	71	HOND-18DP	183
GEA-5D	67	GM - 6	176	GOD-1	69	HAW-4D	71	HOND-18P	183
GEA-6D	67	GM - 6P	176	GOD-2	69	HB-1	71	HOND-19	184
GEA-7D	67	GM - 7	176	GPS-1G	310	HD-1	182	HOND-19D	184
GEA-8D	67	GM - 7P	176	GPS-2G	310	HD-1D	182	HOND-19DP	184
GEB-1D	66	GM - 8	176	GPZ-1G	287	HD-2	182	HOND-19P	184
GG-1D	169	GM - 8P	176	GR-1D	70	HD-2D	182	HOND-20	184
GH-1	178	GM - 9	176	GR-1I	70	HD-3	182	HOND-20D	184
GH-2	178	GM - 9P	176	GR-2D	70	HD-3D	182	HOND-20DP	184
GH-3	178	GM - 10	176	GR-2I	70	HD-4D	182	HOND-20P	184
GH-GX	178	GM - 10P	176	GR-3D	70	HEK-1	71	HOND-22DP	184
GH-HX	178	GM - 11	176	GR-3I	70	HEK-2	71	HOND-23	184
GH-PS	178	GM - 11P	176	GR-4D	70	HEK-3	71	HOND-24DP	184
GIB-1D	67	GM - 12	176	GR-4I	70	HEK-4	71	HOND-24P	184
GIM-1TG	310	GM - 12P	176	GR-5D	70	HEL-1	71	HOND-25P2	182
GIOB-1D	181	GM - 13	176	GR-5I	70	HEN-1	71	HOND-26DP1	185
GIOB-1DP	181	GM - 13P	176	GR-6	70	HEN-1D	71	HOND-26P1	185
GIOB-2I	181	GM - 14	176	GR-6D	70	HEN-1GP	288	HOND-27D	185
GIOB-2IP	181	GM - 14P	176	GR-7	70	HEN-2	71	HOND-28DP	185
GIOB-3P	182	GM - 15D	176	GR-7D	70	HOB-1	72	HOND-28P	185
GIOB-3P2	182	GM - 15DP	176	GR-8	70	HOB-2D	72	HOND-29DP	185
GIU-1	67	GM - 16P	177	GRG-1	69	HOND- 1	182	HOND-29P	185
GIU-1D	67	GM - 17P	177	GTV- 1D	69	HOND- 1P	182	HOND-30DP2	182
GIU-2	67	GM - 18P	177	GTV- 2	69	HOND- 2	182	HOND-30P2	182
GIU-2D	67	GM - 19P	177	GTV- 2D	69	HOND- 2P	182	HOND-31P	185
GIU-3D	67	GM - 20P	177	GTV- 3D	69	HOND- 3D	182	HOND-42P	185
GIU-4	68	GM - 21	177	GTV- 4D	69	HOND- 3I	182	HOND-43	185
GLA-1D	68	GM - 21P	177	GTV- 5D	69	HOND- 4D	182	HOND-43D	185
GLA-2D	68	GM - 22	177	GTV-10	69	HOND- 4DP	182	HOND-43DP	185
GLO- 1D	68	GM - 22P	177	GTV-11	69	HOND- 4DP1	183	HOND-43P	185
GLO- 1I	68	GM - 23	177	GUA-1	69	HOND- 4DP2	182	HOND-45D	185
GLO- 2	68	GM - 23P	177	GUA-1D	69	HOND- 4I	182	HOND-46D	185
GLO- 2D	68	GM - 24	177	GUA-2	69	HOND- 4IP	182	HOND-49	185
GLO- 3	68	GM - 24P	177	GUA-2D	69	HOND- 4IP1	183	HOR-1	72
GLO- 3D	68	GM - 25	177	GUA-3	70	HOND- 5D	183	HOR-2	72
GLO- 4D	68	GM - 25P	177	GUA-3D	70	HOND- 5I	183	HOR-2D	72
GLO- 4I	68	GM - 26	178	GUR-1G	288	HOND- 6D	183	HRM-1	71
GLO- 5I	68	GM - 42	178	GW-1D	178	HOND- 6I	183	HT-1	72
GLO- 6	68	GM - A	178	H		HOND- 7D	183	HTE -1D	72
GLO- 6D	68	GM - AP	178	H-3G	344	HOND- 7I	183	HTE -50	72
GLO- 7	68	GM - B	178	H-3G(CV)	344	HOND- 8D	183	HU -1	188
GLO- 7D	68	GM - BP	178	HA-1D	182	HOND- 8I	183	HU -2P	188
GLO- 8	68	GM - C	178	HA-1I	182	HOND- 9D	183	HU -3	188
GLO- 8D	68	GM - CP	178	HAF-1	70	HOND- 9I	183	HU -AN	188
GLO- 9D	68	GM - D	178	HAF-1D	70	HOND-10	183	HU -DF	188
GLO-10	69	GM - DP	178	HAF-2	70	HOND-10P	183	HU -DFP	188
GLO-11	69	GM - E	178	HAF-2D	70	HOND-11	183	HU -DFP1	188
GLO-12D	69	GM - EP	178	HAF-3D	70	HOND-11P	183	HU -DHP	188
GLO-22	69	GM - H	178	HAF-4	70	HOND-12	183	HU -DNP	188
GLO-22D	69	GM - HP	178	HAG-1D	70	HOND-12P	183	HU -HAAC1	188
GLO-23	69	GM - J	178	HAK-1D	71	HOND-13	183	HU -HAAC2	189
GLO-23D	69	GM - JP	178	HAK-2D	71	HOND-13P	183	HU -HAAC3	236
GM - 1P	175	GM - K	178	HAK-3	71	HOND-14	183	HU -HAAC4	236
GM - 2	175	GM - KP	178	HAK-4	71	HOND-14P	183	HU -HAAC5	189
GM - 2P	175	GMG-1G	310	HAK-5	71	HOND-15	183	HU -HAAP1	189
GM - 3P	175	GMG-2G	310	HAL-1	70	HOND-15P	184	HU -MN	189
GM - 4	175	GMT-1	65	HAR-1I	71	HOND-16D	184	HU -MNP	189
GM - 4P	176	GMT-2	65			HOND-16DP	184	HU -NAAC2	189

REF.	PAG.
HU-NW	189
HU-P	189
HU-SC	189
HU-SR	189
HU-SU	189
HU-SX	189
HU-SY	189
HU-SZ	189
HUD-1	185
HUD-1D	185
HUD-2D	72-185
HUD-3	72
HUN-1D	72
HUW-1	72-196
HUW-1D	72-196
HUW-2	72
HUW-3D	72
HUW-N	73-196
HY-1	196
HY-2	196
HY-2P	196
HY-3	196
HY-3D	196
HY-3DP	196
HY-3DP1	196
HY-3DP2	196
HY-3P2	196
HY-3P3	196
HY-4	197
HY-4P	197
HY-4P2	197
HY-4P3	197
HY-5	197
HY-5P	197
HY-6D	197
HY-6DP	197
HY-7P	197
HY-8	197
HY-8P	197
HY-9P2	197
HY-11DP1	198
HY-11DP3	198
HY-11P3	198
HY-12P3	198
I	
I-1G	344
I-1G NIQ	344
IB-1	73
IB-2	73
ICA-1	73
ICA-4IP	73
ICA-5IP	73
ICS-1D	73
ICS-2D	73
IDM-1G	311
IDM-2G	311
IDM-3G	311
IDM-4G	311
IDM-5G	311

REF.	PAG.
IF-1I	73
IF-2	73
IF-3P	73
IF-4	73
IF-5	73
IF-6	74
IF-15	74
IF-35	74
IF-45-55	74
IF-60-70	74
IF-D20	74
IF-D25	74
IF-D30	74
IF-I20	74
IF-I25	74
IF-I30	74
IF-I40	74
IF-I40L	74
IF-I50	74
IF-I51	74
IF-I60-70	74
IGS-1	74
IL-1D	77
IL-1I	77
IL-2	77
ILC-1D	77
ILC-2D	77
ILC-3	77
ILC-6D	77
ILL-1	77
ILL-2	77
ILL-2D	77
ILS-1	77
IMB-1	77
IMB-1D	77
IMS-3	224
IMS-3C	198
IMS-3P	224
IMS-5	224
IMS-5C	198
IMS-5P	224
IMS-6D	198
IMS-6I	198
IMS-7	198
IMS-7P	198
IMS-8	198
IMS-9	198
IMS-10	198
IMS-11P	198
IMS-12	198
IMS-13	224
IMS-13P	224
IMS-MER	199
IN-1	234
IN-4	234
IN-5	234
INCE-1E	78
INCE-2E	78
ING-6	78
ING-A	78

REF.	PAG.
ING-D	78
ING-M	78
ING-N	78
ING-S	78
ING-W	78
INT-1	78
INT-1D	78
IR-1P	78
IS-1D	78
IS-1G	311
IS-1I	78
IS-1X	249
IS-2D	78
IS-2G	311
IS-2I	78
IS-3D	78
IS-3G	311
IS-3I	78
IS-4	78
IS-4G	312
IS-5D	78
IS-5G	312
IS-6D	78
IS-6G	312
IS-7D	78
IS-8	78
IS-8D	78
IS-10	79
IS-10P	79
IS-14D	79
IS-15	79
IS-16D	79
IS-17D	79
IS-18D	78
IS-19D	78
IS-20	79
ISU-1	199
ISU-2	199
ISU-3D	199
ISU-3DP	199
IT-1G	312
IT-1TG	312
IT-2G	312
IT-3G	312
IT-4G	312
ITO-1D	79
ITO-2D	79
IV-1	79
IV-2D	79
J	
J-1G(CV)	344
J-2G(CV)	344
J-3G	344
J-3G(CV)	344
JAR-1D	79
JAR-1I	79
JAR-2D	79
JAR-2I	79
JAR-3	79

REF.	PAG.
JAR-4D	80
JAR-5D	80
JAR-5I	80
JAR-6	79
JAR-6D	79
JAU-1P	229
JD-1	199
JD-2	199
JD-3D	199
JD-4D	199
JGH-1D	82
JIN-1D	80
JIP-1D	80
JIP-1I	80
JIS-1D	80
JIS-2I	80
JIS-3D	80
JIS-3I	80
JIS-4P	80
JMA-1D	146
JMA-1I	146
JMA-2D	146
JMA-2I	146
JMA-3D	146
JMA-3I	146
JMA-4D	146
JMA-4I	146
JMA-9D	146
JMA-9I	146
JNG-1	82
JNG-1D	82
JNG-2D	82
JNG-3	82
JO-1	80
JOM-1D	80
JPM-1D	81
JPM-1E	81
JPM-1I	81
JPM-2D	81
JPM-2E	81
JPM-2I	81
JPM-3D	81
JPM-4	81
JPM-4D	81
JPM-10D	81
JPM-11D	81
JTF-1I	81
JTF-2I	81
JTF-3	81
JTF-4	81
JU-1	82
JU-2	82
JU-2D	82
JUNI-1	82
JUNI-1D	82
JUNI-2	82
JUNI-2D	82
JUNI-3D	82
JUNI-4D	82
JUNI-5D	82

REF.	PAG.
JUNI-6D	82
JUNI-7D	82
JUNI-8D	82
JUNI-9D	82
JUZU-1	82
JV-1D	82
JV-1I	82
JV-2	82
JV-3D	82
JV-3I	82
JV-4I	82
JV-5I	82
JV-6	82
JV-7	82
JV-7D	82
JW-20G	313
JW-30G	313
JW-40G	313
JW-45G	313
JW-50G	313
JW-70G	313
JW-90G	313
JWL-1D	80
JWL-2D	80
JWL-3D	80
JWL-4D	80
JWL-5	81
JWL-6	81
JWL-7D	81
JWL-9	80
JWL-9D	80
JWL-10D	81
JWL-11D	81
K	
KA-1	82
KA-2	82
KA-3	82
KA-4	82
KA-5	83
KA-6	83
KA-7	82
KA-8	83
KA-10	83
KA-11	83
KAB-1D	83
KAE-1	83
KAE-1G	313
KAE-2	83
KAE-3	83
KAE-3D	83
KAE-4	83
KAE-5	83
KAE-6	83
KAE-6D	83
KAE-7	83
KAE-7D	83
KAE-8	84
KAE-8D	84
KAE-9	84

ÍNDICE GENERAL

GENERAL INDEX

REF.	PAG.	REF.	PAG.	REF.	PAG.	REF.	PAG.	REF.	PAG.
KAE-9D	84	KI-2D	201	LAP-3D	87	LAS-TK	88-202	LF-24	94
KAE-10D	84	KI-3DP	201	LAP-3E	87	LAS-TX	89-202	LF-25	94
KAE-11D	84	KI-3P	201	LAP-3I	87	LAS-U	88-202	LF-26	94
KAE-12D	84	KIC-1	85	LAP-4	87	LAS-V	89-202	LF-27	94
KAE-13D	84	KIF-1	85	LAP-5D	87	LAS-X	88-202	LF-28	94-204
KAE-14	84	KIF-1D	85	LAP-6	87	LAS-XS	89-202	LF-29D	94
KAL-1	84	KIF-2D	85	LAP-7D	87	LAS-XY	89-202	LF-30	94
KAL-2D	84	KIR-1D	86	LAP-8D	87	LAS-Y	89-202	LF-31	95
KAM-1	199	KIR-2	86	LAP-9	87	LASB-1	89	LF-32	93-203
KAM-1D	199	KNA-1D	86	LAP-9D	87	LASB-1D	89	LF-33D	94
KAP-1D	84	KOM-1	201	LAP-10D	87	LASB-1G	288	LF-34	95
KAP-2D	84	KP-1	86	LAP-11D	87	LASB-2	89	LF-35	95
KAS-1G	314	KR-1X	250	LAP-13P	87	LASB-2D	89	LF-36	95
KAS-2G	314	KR-2X	250	LAP-17P	87	LASB-2G	288	LF-37D	95
KAS-4G	314	KR-3X	250	LAP-20P	87	LASB-3D	89	LF-38D	95
KAS-6G	314	KR-4X	250	LAP-21P	87	LASB-3G	288	LF-39D	204
KAW-1D	199	KR-5X	250	LAP-22P	87	LASB-4G	288	LF-40	94
KAW-1I	199	KR-6X	250	LAP-23P	87	LB-1	91	LF-41	95
KAW-2D	199	KR-7X	250	LAP-28D	87	LB-1D	91	LF-43	94
KAW-2I	199	KR-8X	250	LAP-29D	87	LB-2D	92	LF-44	95
KAW-3	199	KR-9X	251	LAP-30D	87	LB-2DP	92	LF-45	95
KAW-4	200	KR-10X	251	LAP-34D	87	LB-3	92	LF-46	95
KAW-5	200	KR-11X	251	LAP-42D	88	LB-3D	92	LF-BL	204
KAW-5P	200	KR-12X	251	LAP-43D	88	LB-4D	92	LF-RO	204
KAW-6DP	200	KR-13X	251	LAP-44D	88	LCK-1X	252	LF-ROP	204
KAW-6P	200	KR-14X	251	LAP-45D	88	LEA-1D	89	LF-SL	204
KAW-7P	200	KR-15X	251	LAP-46D	88	LEA-2D	89	LF-SLP	204
KAW-8	200	KR-16X	251	LAP-88	88	LEG-1D	89	LF-WB	204
KAW-8D	200	KR-17X	252	LAP-96D	88	LF-1D	92-203	LF-WBP	205
KAW-9P	200	KRA-1D	86	LAR-1G	288	LF-1I	92-203	LF-WR	205
KAW-10P	200	KRA-2	86	LAR-1I	88	LF-2	93-203	LIN-1D	89
KAZ-1	84	KRE-1D	86	LAR-2G	332	LF-3	203	LIN-1I	89
KAZ-2	84	KRP-1G	315	LAR-3G	332	LF-4I	93-203	LIN-2	89
KAZ-3	84	KUR-1G	315	LAS-1D	88-202	LF-5	93-203	LIN-2G	315
KAZ-4	84	KWI-1	86	LAS-2	88-202	LF-5D	93-203	LIN-3D	89
KAZ-5	84	KWI-2D	86	LAS-3	88-202	LF-6	203	LIN-3G	315
KAZ-5D	84	KYM-1DP	201	LAS-4	88-202	LF-7	93-203	LIN-3I	89
KAZ-6	85	KYM-1P	201	LAS-4D	88-202	LF-7D	93-203	LIN-4D	89
KAZ-7	85	KYM-2	201	LAS-5	88-202	LF-8	93-204	LIN-4I	89
KE-1	85	KYM-2D	201	LAS-5D	88-202	LF-8D	93-204	LIN-5D	90
KE-3	85	KYM-2DP	201	LAS-6	88-202	LF-9	204	LIN-5I	90
KE-4	85	KYM-2P	201	LAS-6D	88-202	LF-10	93	LIN-6D	90
KE-5	85	KYM-3P	201	LAS-7	88	LF-11	93-204	LIN-6I	90
KEN-1	200	KYM-3DP	201	LAS-8	88	LF-11D	93-204	LIN-7D	90
KEN-1D	200			LAS-9	88	LF-12	93-203	LIN-7I	90
KFV-1	85	L		LAS-10	89	LF-12D	93-203	LIN-8D	90
KFV-1X	249	L-3G	344	LAS-11	89	LF-13	93	LIN-8I	90
KFV-2X	249	L-3G(CV)	344	LAS-11D	89	LF-13D	93	LIN-9	90
KFV-3X	249	LA-1D	201	LAS-12D	89	LF-14D	93	LIN-10D	90
KFV-C	85	LA-1DP	201	LAS-AX	88-202	LF-15	93-204	LIN-10I	90
KFV-D	85	LA-2	201	LAS-AX-L	89	LF-15D	93-204	LIN-11D	90
KFV-E	85	LA-2P	201	LAS-BT	202	LF-16	93	LIN-11I	90
KFV-F	85	LA-3D	201	LAS-CR	202	LF-17	93-204	LIN-12D	90
KFV-L	85	LA-3DP	201	LAS-FH	88-202	LF-18D	93	LIN-12I	90
KFV-M	85	LA-4D	202	LAS-KT	88-202	LF-19	94	LIN-13	90
KFV-N	85	LA-4DP	202	LAS-P	202	LF-20	94	LIN-14D	89
KFV-O	85	LAF-1D	86	LAS-R	89-202	LF-20D	94	LIN-14I	89
KI-1D	200	LAP-1	86	LAS-RC	202	LF-21	94	LIN-15D	89
KI-1DP	200	LAP-2D	86	LAS-SX	89-202	LF-22	94	LIN-15I	89
KI-1DP1	200	LAP-2E	86	LAS-TB	202	LF-23	94	LIN-16	90

REF.	PAG.	REF.	PAG.	REF.	PAG.	REF.	PAG.	REF.	PAG.
LIN-16D	90	LWO- 2	92	MAZ- 6DP	206	MCM-32D	99	MER-13I	100
LIN-17	90	LWO- 2D	92	MAZ- 6P	206	MCM-33	99	MER-14I	100
LIN-17D	90	LWO- 7D	92	MAZ- 7D	206	MCM-35	99	MER-15	100
LIN-18	90	LWO- 8	92	MAZ- 7DP	206	ME - 1	189	MER-16	100
LIN-18D	90	LWO- 9	92	MAZ- 7DP1	206	ME - 1P	189	MER-16D	100
LIN-19D	90	LWO-26D	92	MAZ- 8D	206	ME - 2P	190	MER-17	100
LIN-20D	89	LYF-1T	96	MAZ- 8DP	206	ME - 3P	190	MER-18	100
LIN-21D	90	LYF-2T	96	MAZ-11D	206	ME - 4P	190	MER-19D	101
LIN-25	90			MAZ-11DP1	206	ME - 5P	190	MER-20D	101
LIN-25D	90	M		MAZ-13D	206	ME - 6P	190	MER-21D	101
LIP- 1D	90	MA-5D	96	MAZ-13DP	206	ME - 7P	190	MERI-1D	207
LIP- 1GD	91	MAC-1G	336	MAZ-13DP1	207	ME - 8P	190	MERI-1DP	207
LIP- 1I	90	MAG-2DP	96	MAZ-14D	207	ME - 9P	190	MET-2D	101
LIP- 2	91	MAK-1	205	MAZ-15D	207	ME -10P	190	MEZ-1D	101
LIP- 2D	91	MAR-1P	205	MAZ-16	207	ME -11P	190	MG-6D	40
LIP- 3	91	MAS - 1	96	MAZ-21DP1	207	ME -12P	190	MG-6I	40
LIP- 4	91	MAS - 1D	96	MBL-1	103	ME -13DP	190	MG-6S	40
LIP-28D	91	MAS - 2D	96	MBL-1D	103	ME -14P	190	MG-9	40
LIP-33	91	MAS - 3D	96	MCH-1	101	ME -HD	191	MGA-1	101
LIT-1I	91	MAS - 4D	96	MCH-1D	101	ME -HDP	191	MGA-1D	101
LIT-2D	91	MAS - 5D	96	MCH-2	101	ME -HF	191	MGA-2	101
LIT-2GD	91	MAS - 6	96	MCH-2D	101	ME -HFP	191	MGA-3	101
LIT-3D	91	MAS - 7	96	MCL-1D	97	ME -HM	191	MI-1D	101
LIT-5D	91	MAS - 7D	96	MCM- 1	97	ME -HMLP	191	MI-2D	101
LIT-5I	91	MAS - 8	96	MCM- 1G	288	ME -HMP	191	MI-3D	102
LIT-7D	91	MAS - 9	97	MCM- 2D	97	ME -HU	191	MI-4D	102
LMP-1	202	MAS - 9D	97	MCM- 2G	315	ME -HUP	191	MI-5D	102
LMP-1P	202	MAS -10	97	MCM- 2I	97	ME -HY	191	MIL-1	102
LMP-2	203	MAS -10D	97	MCM- 3D	98	ME -HYP	191	MIL-2	102
LMP-2P	203	MAS -11	96	MCM- 3G	315	ME -HZ	191	MIN-1D	102
LMP-3	203	MAS -11D	96	MCM- 3I	98	ME -HZP	191	MIS-1	207
LMP-3P	203	MAS -12D	96	MCM- 4D	98	ME -L	191	MIT- 1D	207
LMP-4	203	MAS -13D	97	MCM- 4EC	98	ME -NU	191	MIT- 1DP	207
LMP-4P	203	MAS -15P	97	MCM- 4G	289	ME -NUP	191	MIT- 1I	207
LMP-4P1	203	MAS -17	97	MCM- 4I	98	ME -NY	191	MIT- 1IP	207
LMP-5	203	MAS -17D	97	MCM- 4SS	98	ME -NYP	191	MIT- 2D	207
LMP-5P	203	MAS -18D	97	MCM- 5D	98	ME -S	191	MIT- 2DP	207
LMP-5P1	203	MAS -19	97	MCM- 5G	315	ME -SP	192	MIT- 2I	207
LO-1D	92	MAS -22D	96	MCM- 5I	98	ME -VA	192	MIT- 2IP	207
LO-1I	92	MAS -24D	96	MCM- 6	98	MEC-5D	99	MIT- 3	208
LO-2D	92	MAS -29D	97	MCM- 7	98	MEL-1	99	MIT- 3P	208
LO-2I	92	MASL-1	97	MCM- 8	98	MEL-2D	100	MIT- 4	208
LO-3D	92	MAX-1G	336	MCM-10	98	MEL-3	100	MIT- 4P	208
LO-4D	92	MAX-2G	336	MCM-11S	98	MEL-4	99	MIT- 5	208
LOC-1D	92	MAZ- 1D	205	MCM-12D	98	MEL-4D	99	MIT- 5P	208
LPO- 1	88	MAZ- 1I	205	MCM-13D	98	MEL-5P	100	MIT- 6	208
LPO- 2	88	MAZ- 2D	205	MCM-16	98	MER- 1D	100	MIT- 6P	208
LT-1	95	MAZ- 2DP	205	MCM-18D	98	MER- 1T	100	MIT- 7	208
LUC-1D	95	MAZ- 2I	205	MCM-21D	98	MER- 2I	100	MIT- 7P	208
LUC-2	95	MAZ- 2IP	205	MCM-24B	99	MER- 3I	100	MIT- 8D	208
LUMA-1D	95	MAZ- 3D	205	MCM-24C	99	MER- 3T	100	MIT- 8DP	208
LUMA-1I	95	MAZ- 3DP	205	MCM-24D	99	MER- 4I	100	MIT- 9	209
LUMA-2D	95	MAZ- 3I	205	MCM-24E	99	MER- 5I	100	MIT-10	209
LUMA-2I	95	MAZ- 3IP	205	MCM-24F	99	MER- 6I	100	MIT-11D	209
LUMA-3D	95	MAZ- 4	205	MCM-26	99	MER- 7I	100	MIT-12	209
LUMA-3I	95	MAZ- 4P	205	MCM-27	99	MER- 8I	100	MIT-13D	209
LUMA-4D	95	MAZ- 5D	205	MCM-29D	99	MER- 9I	100	MIT-14D	209
LUMA-4I	95	MAZ- 5DP	206	MCM-30D	99	MER-10I	100	MIT-15P	208
LWO- 1	92	MAZ- 6	206	MCM-31	99	MER-11I	100	MIW-1	102
LWO- 1D	92	MAZ- 6D	206	MCM-31D	99	MER-12I	100	MIW-2	102

ÍNDICE GENERAL

GENERAL INDEX

REF.	PAG.	REF.	PAG.	REF.	PAG.	REF.	PAG.	REF.	PAG.
MIW-3	102	MT-14G	319	NE-10	211	NE-39P	215	OJ- 9D	106
MIW-4	102	MT-15G	319	NE-10P	211	NE-40	215	OJ-10	106
MLM-1D	102	MT-16G	319	NE-11	211	NE-40P	215	OJ-11	106
MLM-2	102	MT-17PG	319	NE-11P	211	NE-41P	216	OJ-12	106
MLM-3	103	MT-18G	319	NE-11P1	211	NE-42	216	OJ-13	106
MLM-4	103	MT-AG	104	NE-11P2	211	NE-42P	216	OJ-14	106
MLM-5	102	MT-AGP	104	NE-11P3	212	NE-42P1	216	OJ-15	106
MLM-5D	102	MT-CG	104	NE-12	212	NE-43	216	OJ-16	106
MLM-6	103	MT-CGP	104	NE-12P	212	NE-44P	214	OJ-17	106
MLM-7	103	MT-DGP	104	NE-13	212	NE-45	216	OJ-18P	106
MM-1X	252	MT-EG	104	NE-14	212	NE-45P	216	OJ-19	106
MNO-1D	103	MT-EGP	104	NE-15D	210	NE-46	216	OJ-J	106
MOD-1DP	209	MT-GG	104	NE-15DP	210	NE-47	216	OJ-K	106
MOG-1D	103	MT-GGP	104	NE-15DP1	210	NE-48	216	OJ-L	106
MOI-1G	316	MTL-1	101	NE-15I	210	NE-49	216	OJ-M	106
MOI-2G	316	MTL-1D	101	NE-15IP	210	NE-50P	216	OJ-Q	106
MOI-3G	316	MTL-1G	315	NE-15IP1	210	NE-51P2	217	OL-5D	106
MOK-1G	289	MTL-2G	316	NE-16	212	NE-52P	217	OLIV-1	107
MON-1D	103	MTO-1	101	NE-18	212	NE-53	217	OM-1	107
MON-1I	103	MUL-T 2P	104	NE-18P	212	NE-54P	217	OMC-1D	107
MON-2D	103	MUL-T 3P	104	NE-19	212	NE-55P	217	OMC-1G	319
MON-2I	103	MUL-T 3P1	104	NE-19P	212	NE-56	217	OMC-2D	107
MOR-1X	252	MUL-T 4P	104	NE-19P1	212	NE-57	217	OMC-3	107
MOR-2X	252	MUL-T 5P	104	NE-20	212	NE-58D	217	OMC-4	107
MOS-1	209	MUL-T 6	105	NE-20P	212	NE-59P	217	OMC-5D	107
MP-1D	104	MUL-T 6D	105	NE-20P1	212	NE-60C1	217	OMC-6D	107
MP-1I	104	MUL-T 7P	104	NE-20P2	213	NE-60C2	217	OMI-1	107
MPA-1G	289	MUL-T 8P1	104	NE-20P3	213	NE-61D	218	OMI-1D	107
MQ-1D	96	MUL-T 9P1	104	NE-22P	213	NE-62	218	ON-1D	107
MQ-1I	96	MUL-T10P	105	NE-22P1	213	NE-63D	218	ON-1I	107
MR-1	103	MUL-T11P1	104	NE-22P2	213	NEF-1X	253	OP- 1	192
MR-2	103	MUL-T16P	105	NE-23	213	NEF-2Z 1	340	OP- 6	192
MR-3	103	MXS-1	97	NE-24	213	NEF-2Z 2	340	OP- 7	192
MSM-1D	104			NE-24P	213	NEF-2Z 3	340	OP- 8	192
MSM-2D	104			NE-24P1	213	NEF-2Z 4	340	OP- 9	192
MSV-1	104	N		NE-25	213	NEF-2Z 5	340	OP-11C1	192
MSV-1X	252	N-1G	345	NE-26	213	NEF-2Z 6	340	OP-AB	192
MSV-2	104	N-1G NIQ	345	NE-27	213	NEF-2Z 7	340	OP-ABP	192
MT- 1G	316	NAB-1X	252	NE-28	213	NEF-2Z 8	340	OP-BA	192
MT- 2G	316	NE- 1	209	NE-28	213	NEF-2Z 9	340	OP-BAP	192
MT- 2TG	316	NE- 1D	209	NE-29	214	NEF-2Z10	340	OP-BB	192
MT- 3G	316	NE- 1DP	209	NE-29P	214	NO-1	105	OP-CC	192
MT- 3P1G	317	NE- 1P	209	NE-30	214	NTC-10D	105	OP-D	192
MT- 3PG	317	NE- 2	209	NE-30P	214	NTC-6	105	OP-DD	192
MT- 4G	317	NE- 3	210	NE-31	214			OP-DP	192
MT- 5G	317	NE- 3D	210	NE-31P	214			OP-EE	192
MT- 5P1G	317	NE- 3P	210	NE-32	214	O		OP-FF	192
MT- 6G	317	NE- 3P1	210	NE-32P	214	OA-1	107	OP-HA	193
MT- 6P1G	318	NE- 3P2	210	NE-33P	214	OCA-1D	105	OP-HB	193
MT- 6PG	318	NE- 4	210	NE-33P1	214	OCA-2D	105	OP-HG	193
MT- 8G	318	NE- 4D	210	NE-34P	214	OF-1	105	OP-HH	193
MT- 8P1G	318	NE- 4P	210	NE-35	214	OF-2	105	OP-J	193
MT- 8PG	318	NE- 4P1	210	NE-35P	215	OJ- 1D	105	OP-JP	193
MT- 9G	318	NE- 4P2	210	NE-35P2	215	OJ- 2I	105	OP-NA	193
MT- 9P1G	318	NE- 5	210	NE-36	215	OJ- 3D	105	OP-NB	193
MT- 9PG	318	NE- 6	211	NE-36P	215	OJ- 3I	105	OP-R	193
MT-10G	317	NE- 6P	211	NE-36P1	215	OJ- 4D	106	OP-RP	193
MT-10P1G	318	NE- 7	211	NE-37	215	OJ- 5I	106	OP-S	192
MT-10PG	318	NE- 8	211	NE-37P	215	OJ- 6D	106	OP-SP	192
MT-11G	318	NE- 9	211	NE-38	215	OJ- 6I	106	OP-SP1	193
		NE- 9P	211	NE-38P1	215	OJ- 7I	105		

REF.	PAG.
OP-T	193
OP-TP	193
OP-WHC1	193
OP-WHP	193
OP-WYP	193
OR-0G	333
OR-1G	333
OR-1I	107
OR-2G	319
OR-3G	289
OR-4G	333
OR-5G	333
OR-6G	289
ORK-1D	108
ORO-1D	108
OST-1G	289
OST-2G	289

P

PAD-1D	108
PAD-2D	108
PAD-3	108
PAD-3D	108
PAP-1	108
PAP-1X	253
PAP-2	108
PAP-2X	253
PAP-3	108
PAP-4	108
PAP-5	108
PAP-6	108
PAT-1G	319
PC-1D	109
PC-1T	109
PC-2D	109
PC-3TP	109
PCI-1T	108
PEN-1	109
PEN-1D	109
PEN-2	109
PET-1	109
PEU-1C1	236
PEU-2C1	236
PFA- 1	109
PFA- 2	109
PFA- 3	109
PFA- 4	109
PFA- 5	109
PFA- 6	110
PFA- 6D	110
PFA- 7D	110
PFA- 8D	110
PFA- 9D	110
PFA-10D	109
PFA-11D	109
PFA-12D	109
PFA-13D	109
PFA-14D	109
PFA-15D	109
PFA-16D	109

REF.	PAG.
PFA-17D	109
PFA-18D	109
PFA-21	110
PFA-22	109
PFA-22D	109
PGO-1	221
PGO-2P	221
PHI-52	110
PHO-1	110
PIC-1E	110
PIC-8D	110
PJ-1	221
PJ-2	221
PJ-2P	221
PJ-3	221
PJ-K	221
PJ-KP	222
PLL-1	222
PO -1P	193
PO -2P	194
PO -HC	194
PO -HCP	194
PO -NC	194
PO -NCP	194
POL-3TEC	110
POL-4E	110
POL-5TEC	110
POS-1DP	222
PPT-1G	289
PPT-2G	289
PPT-3G	289
PR- 1	110
PR- 1D	110
PR- 1G	321
PR- 2	110
PR- 2G	336
PR- 3	110
PR- 3G	321
PR- 4D	110
PR- 4G	321
PR- 4I	110
PR- 5D	111
PR- 5I	111
PR- 6	111
PR- 7	111
PR- 8	111
PR- 9	111
PR- 9D	111
PR-10	110
PR-11	110
PR-12	111
PR-13	111
PR-14	111
PR-15D	111
PR-16	111
PR-16D	111
PR-17D	111
PR-18	111
PR-19	111
PR-20	111

REF.	PAG.
PR-20D	111
PRE-1I	222
PRE-2I	222
PRE-3	222
PTN- 1D	110
PTN- 1G	320
PTN- 2D	110
PTN- 2G	320
PTN- 3G	320
PTN- 4G	320
PTN- 5G	320
PTN- 6G	320
PTN- 7G	320
PTN-10G	320
PTN-11G	321
PTN-13G	321
PTN-13TG	321
PTN-14G	321
PTN-15G	321

R

RAZ-1D	112
RE-1	111
RE-1D	111
RE-2	111
RE-2D	111
RE-3D	112
RE-4D	111
RE-5D	112
REG-1D	111
REN-1G	290
REN-2G	290
REVI-1G	321
REX-1D	112
REX-1G	290
REX-2G	290
RGL-1G	322
RGM -1D	112
RGM -1I	112
RGM -2	112
RI-1D	112
RI-1I	112
RI-2D	112
RI-2I	112
RI-3D	112
RI-3I	112
RIG-1D	112
RIO-1D	112
RIT-1D	112
RO- 1D	113-222
RO- 1DS	222
RO- 1I	113-222
RO- 1IS	222
RO- 1X	252
RO- 2D	113-222
RO- 2I	113-222
RO- 3	222
RO- 4D	113-222
RO- 4I	113-222
RO- 5D	113-222

REF.	PAG.
RO- 5I	113-222
RO- 6D	113-222
RO- 6I	113-222
RO- 7D	113-222
RO- 7I	113-222
RO- 8D	113-222
RO- 8I	113-222
RO- 9D	113
RO- 9I	113
RO-10D	113
RO-10I	113
RO-11D	113-222
RO-11I	113-222
RO-12D	114-223
RO-12I	114-223
RO-14	223
RO-15	223
RO-16D	114-223
RO-16I	114-223
RO-17	223
RO-18I	113
RO-19D	113
RO-19I	113
RO-20D	113
RO-20I	113
RO-21D	113
RO-21I	113
RO-22I	113
RO-23D	113
RO-24D	114
RO-24I	114
RO-25D	114
RO-25I	114
RO-26D	114
RO-26I	114
RO-27D	114
RO-27I	114
RO-28D	114
RO-28I	114
RO-29D	114
RO-30	113-222
RO-30D	113-222
RO-31D	114
RO-32D	113-222
RO-33	113-222
RO-34D	114
RO-36D	114
RO-37	114
RO-37D	114
RO-38	114
RO-38D	114
RO-39	114
RO-40	114
RO-40D	114
RO-41	114
RO-42	114
ROS-1D	223
ROS-2	223
ROSE -1	114
ROY-1	114

REF.	PAG.
RSS-1	115
RSS-2D	115
RST-1	25
RU - 1D	114
RU - 2D	114
RU - 2I	114
RU - 3D	114
RU - 4D	114
RU - 5D	115
RU - 5I	115
RU - 6I	115
RU - 7D	115
RU - 8D	115
RU - 9D	115
RU - 9I	115
RU -10D	114
RU -11D	115
RU -12D	115
RU -13D	115
RU -14D	115
RU -15	115
RU -16D	115
RU -19D	114
RU -GC	115
RU -GK	115
RU -GK7	115
RU -GL	115
RU -GL7	115
RU -GM	115
RU -GM7	115
RU -GS	115
RU -GS7	115
RU -K	115
RU -KD	115
RU -L	115
RU -M	115
RU -TL	114
RUB-1G	322
RUB-2G	322
RUB-3G	336
RUB-4G	322
RUB-5G	322
RUB-6G	333
RUB-7G	322
RUB-8G	322
RUB-9G	322
RUE-2G	333
RUS-1	115
RUS-2	115

S

SA-1	116
SA-1D	116
SA-2	116
SA-3D	116
SA-3I	116
SA-4	116
SAA-1P	223
SAA-1P1	223
SAA-2P	223

ÍNDICE GENERAL

GENERAL INDEX

REF.	PAG.	REF.	PAG.	REF.	PAG.	REF.	PAG.	REF.	PAG.
SAA-AC	223	SI-1D	226	SLG-3	117	SR-4	125	STS-13D	124
SAA-ACP	223	SI-2D	226	SLG-4	117	SR-5	125	STS-21D	124
SABT-1	116	SI-3	226	SLG-5	117	SRM-1G	324	STS-28	123
SAF-1G	323	SI-3D	226	SLG-6	117	SSA-1P1	226	STS-35	124
SAF-2G	323	SI-4	226	SLG-7	117	SSO-1	120	STS-38	124
SAG-1T	135	SI-4D	226	SLG-8	117	SSO-2	120	STS-B1	124
SAM-1D	116	SI-5D	226	SLG-9	117	ST-1I	122	STS-T14	124
SAM-1G	323	SIA-2G	324	SLG-10	117	ST-2	122	STS-TV 3	124
SAM-2D	116	SIA-3G	324	SLG-11	117	STA-1	122	STS-TV 5	124
SAM-2G	323	SIB-1G	337	SLG-12	117	STA-1D	122	STS-TV 8	124
SAM-4G	323	SIB-2G	324	SLG-13	117	STA-2	122	STS-TV 9	124
SAM-5G	323	SIB-3G	325	SLG-14	117	STA-2D	122	STS-X5	124
SAR-1	116	SIB-4G	325	SLG-15	117	STA-3	122	STS-X6	124
SAR-1D	116	SIB-5G	325	SLG-16	117	STA-3D	122	STUV-1D	124
SAR-2D	116	SID-1	119	SLG-17	117	STA-4	122	STUV-1I	124
SAR-3D	116	SID-2	119	SLG-18	117	STA-4D	122	STUV-2	125
SAR-4	116	SIM-900	167	SLG-19	117	STA-5	122	STUV-3	124
SAR-4D	116	SIM-1200	160	SLG-20	117	STA-5D	122	SUB-2P	227
SAR-5D	116	SIP-1	226	SLG-21	117	STB-1	124	SUZU-1D	227
SAR-6	116	SIP-2	226	SLG-22	117	STB-1D	124	SUZU-1I	227
SAR-6D	116	SIP-3	226	SLG-23	117	STE-1	123	SUZU-2D	227
SAT-1D	117	SIS-1	119	SLG-24	117	STE-2D	123	SUZU-2I	227
SAT-2	117	SIS-2	119	SLG-25	117	STE-3	123	SUZU-3I	227
SB-1PG	323	SIS-3	119	SM-1	119	STE-4	123	SUZU-4D	227
SCC-1D	117	SIS-4D	119	SM-2	119	STE-5D	123	SUZU-4DP	227
SCH-1D	117	SIS-5D	119	SM-3	119	STE-6	123	SUZU-4I	227
SCO-1	18	SIS-6	119	SM-3D	119	STE-7	123	SUZU-4IP	227
SCR-1	118	SIS-6D	119	SM-4	119	STE-8D	123	SUZU-5	227
SDR-1G	325	SIS-7D	119	SM-4D	119	STE-9D	123	SUZU-5P	228
SDR-2G	325	SIS-8	120	SOF-1	120	STE-10	123	SUZU-6	228
SDR-3G	325	SIS-8D	120	SOF-2	120	STE-11	123	SUZU-7	228
SE-AHP	194	SIS-9	120	SOFI-1D	120	STE-12	123	SUZU-7DP	228
SE-AN	194	SIS-9D	120	SOFI-1I	120	STE-13D	123	SUZU-7P	228
SEA-1	117	SIX-1	225	SOFI-2D	120	STE-14D	123	SUZU-8	228
SEA-2	118	SIX-1P	225	SOFI-2I	120	STF-1	124	SUZU-8I	228
SEC-1	118	SIX-1P1	225	SOFI-3I	120	STF-1D	124	SUZU-8P	228
SEC-1G	323	SIX-1P2	225	SOFI-4	120	STG-1	123	SUZU-9P	228
SEC-2	118	SIX-2	225	SOFI-4D	120	STK-1	122	SUZU-10	228
SEC-2G	324	SIX-2P	225	SOFI-5	120	STL-1D	122	SUZU-10P	228
SEC-3	118	SIX-2P2	225	SOFI-6	120	STL-2I	122	SUZU-11D	228
SEC-3G	324	SIX-3P	225	SOL-1	120	STR-1	123	SUZU-11DP	228
SEC-4G	324	SIX-3P1	225	SOP-1D	120	STR-2	123	SUZU-12DP	228
SEC-7G	324	SIX-3P2	225	SOS-1D	121	STR-3	227	SUZU-13DP	229
SEL-1D	118	SIX-4	225	SOS-2D	121	STR-4	123-227	SUZU-13P	229
SEL-1I	118	SIX-4P	225	SOS-3	121	STR-5	123	SUZU-14P2	229
SEL-2D	118	SIX-5P	226	SOS-4D	121	STS-1D	123		
SEL-2I	118	SJL-1	120	SOS-5	121	STS-1DP	123	T	
SEL-3D	118	SKO-1	170	SPI-1	121	STS-1I	123	TAI-1	125
SEL-4D	118	SKO-1P	170	SPI-1D	121	STS-2D	227	TAL-1	125
SEN-1D	118	SKO-2	170	SQ-1	121	STS-2DP	227	TAL-1D	125
SEN-2D	118	SKO-3I	170	SQ-2	121	STS-3D	123	TAL-2	125
SER-1G	337	SKO-3IP	170	SQ-3D	121	STS-3I	123	TAL-3	125
SER-3D	118	SKO-4	170	SQ-4	121	STS-4D	123	TAP-1P	229
SH-1I	119	SKO-5P	171	SQ-5D	121	STS-4DP	123	TAP-2	229
SHA-1	119	SKO-6	171	SQ-6	121	STS-5D	227	TAT-1D	229
SHI-1	119	SKO-7	171	SQ-7	122	STS-5DP	227	TAT-1DP	229
SHI-1D	119	SKO-8	171	SQ-8D	122	STS-6D	123	TAT-2D	229
SHI-2D	119	SL-1	118	SR-1I	125	STS-7D	124	TAT-2DP	229
SHI-3D	119	SLG-1	117	SR-2	125	STS-11	227	TAY-1	126
SHR-1	117	SLG-2	117	SR-3	125	STS-12D	124	TC-1	126

REF.	PAG.	REF.	PAG.	REF.	PAG.	REF.	PAG.	REF.	PAG.
TC-2	126	TIT-12D	129	TOK-45	131	TOYO- 8	231	TRI- 8I	133
TE - 1D	126	TIT-13	129	TOK-45D	131	TOYO- 8IP	231	TRI- 9D	133
TE - 1G	290	TIT-15	129	TOK-46	131	TOYO- 8P	231	TRI- 9I	133
TE - 1I	126	TIT-15D	129	TOK-46D	131	TOYO- 9	231	TRI-10D	133
TE - 2G	290	TIT-16D	129	TOK-47	131	TOYO- 9P	231	TRI-10I	133
TE - 3	126	TIT-17	129	TOK-47D	131	TOYO- 9P1	231	TRI-11D	133
TE - 3G	290	TIT-18D	129	TOK-48	131	TOYO-10	231	TRI-11I	133
TE - 4	126	TIT-19D	128	TOK-48D	131	TOYO-10P	231	TRI-12D	133
TE - 7D	127	TK-2D	126	TOK-49	131	TOYO-10P1	231	TRI-12I	133
TE - 8D	127	TK-2I	126	TOK-50	131	TOYO-11	231	TRI-13	133
TE - 8DKT1	127	TKY-1	125	TOK-51	131	TOYO-11P	231	TRI-14	133
TE - 8I	127	TKY-2	125	TOK-52	131	TOYO-11P1	231	TRI-15	133
TE - 9D	127	TKY-3	125	TOK-53	131	TOYO-12	231	TRI-16	133
TE -10I	127	TOK- 2	130	TOK-54	131	TOYO-12D	231	TRI-17D	133
TE -11D	127	TOK- 2D	130	TOK-55	131	TOYO-12DP1	231	TRI-18	133
TE -23	127	TOK- 3	130	TOK-56D	131	TOYO-12P1	231	TRI-18D	133
TE -28	127	TOK- 3D	130	TOK-58	131	TOYO-13	231	TRI-19	133
TE -T10	127	TOK- 4D	130	TOK-59	131	TOYO-13P1	231	TRI-19D	133
TE -T10D	127	TOK- 5D	130	TOK-60	131	TOYO-14	230	TRI-20	133
TE -T11	127	TOK- 6	130	TOK-61	131	TOYO-14P	230	TRL-1P	132-233
TE -T12PLUS	127	TOK- 6D	130	TOK-62	131	TOYO-15	232	TRL-2	132
TE -T60	127	TOK- 7D	130	TOK-62D	131	TOYO-15P	232	TRM- 4	134
TE -T62	127	TOK- 8	131	TOK-63	131	TOYO-16	232	TRM-11D	134
TE -T80	127	TOK- 9	130	TOK-64	131	TOYO-16P	232	TRO-1	126
TE -T8OSC	127	TOK-10D	130	TOK-65	131	TOYO-16P1	232	TRO-1D	126
TE -T82	127	TOK-11	130	TOK-66	131	TOYO-17	232	TRP-1D	233
TEC-1G	325	TOK-12	130	TOK-67	131	TOYO-17P	232	TRU- 7	134
TEC-2	126	TOK-13D	130	TOK-68	131	TOYO-18P	232	TRU- 8P	135
TEI-1D	126	TOK-14D	130	TOK-69	131	TOYO-19P	232	TRV-1	132
TEM-D35	126	TOK-15	130	TOK-70	131	TOYO-20D	232	TRV-1D	132
TEM-D55	126	TOK-16D	130	TOK-71	131	TOYO-22	232	TSI-1G	325
TEM-I35	126	TOK-17D	130	TOK-71D	131	TOYO-22D	232	TST-1	134
TEM-I55	126	TOK-18	130	TOK-72	131	TOYO-23	233	TTN-1G	326
TEU-1	229	TOK-19	130	TOK-73	131	TOYO-23P	233	TTN-2G	326
TH-1	128	TOK-20	130	TOK-74	131	TOYO-24	233	TUF-1X	253
TI-1	128	TOK-21	131	TOK-75	131	TOYO-25	233	TUF-2X	253
TI-1D	128	TOK-21D	131	TOK-76	131	TOYO-26	233	TUF-3X	253
TIF- 1D	128	TOK-22	131	TOK-77	131	TOYO-27	233	TUL-1D	135
TIF- 2D	128	TOK-23	130	TOK-78	131	TOYO-28P	233	TUL-2D	135
TIF-15-20	128	TOK-24	131	TOM-1D	132	TOYO-29	233	TUS-1D	135
TIF-25D	128	TOK-25	130	TOO-1D	229	TOYO-30P1	233	TUS-1G	326
TIF-30D	128	TOK-26	130	TOO-2	230	TOYO-37D	233	TUS-2D	135
TIF-40D	128	TOK-27	130	TOP-1	132	TOYO-K1	230	TV- 1D	134
TIF-50-60	128	TOK-28D	130	TOV-1	132	TOYO-K1P	230	TV- 1G	290
TIG-1D	128	TOK-29D	130	TOV-1G	326	TR-1G	326	TV- 2D	134
TIT- 1D	128	TOK-30	130	TOV-2	132	TRI- 1D	133	TV- 2G	290
TIT- 2	128	TOK-31	130	TOV-3	132	TRI- 1I	133	TV- 3D	134
TIT- 2D	128	TOK-32	130	TOV-4	132	TRI- 2D	133	TV- 3G	291
TIT- 2GD	129	TOK-33	130	TOV-5	132	TRI- 2I	133	TV- 4D	134
TIT- 3	129	TOK-34D	130	TOV-6	132	TRI- 3D	133	TV- 5G	291
TIT- 4	129	TOK-37	131	TOV-7	132	TRI- 3I	133	TV- 7G	291
TIT- 5	129	TOK-38	131	TOYO- 2	230	TRI- 4D	133	TV- 8G	291
TIT- 6	129	TOK-39	131	TOYO- 3	230	TRI- 4I	133	TV- 9G	291
TIT- 7D	229	TOK-40	131	TOYO- 3P	230	TRI- 5D	133	TV-10G	291
TIT- 8D	129	TOK-41	131	TOYO- 4	230	TRI- 5I	133	TV-11	134
TIT- 8GD	129	TOK-41D	131	TOYO- 4P	230	TRI- 6D	133	TV-11G	291
TIT- 9	129	TOK-42	131	TOYO- 5	230	TRI- 6I	133	TV-12	134
TIT- 9D	129	TOK-43	131	TOYO- 5P	230	TRI- 7D	133	TV-12G	291
TIT-10	128	TOK-44	131	TOYO- 5P1	230	TRI- 7I	133	TV-13	134
TIT-11D	129	TOK-44D	131	TOYO- 6	230	TRI- 8D	133	TV-13G	291

ÍNDICE GENERAL

GENERAL INDEX

REF.	PAG.
TV-14G	291
TV-15D	134
TV-15G	291
TV-16D	134
TV-16G	291
TV-17	134
TV-17D	134
TV-17G	291
TV-18D	134
TV-18G	291
TV-19D	134
TV-19G	291
TV-20	134
TV-20G	291
TV-21	134
TV-21G	291
TV-22	134
TV-22D	134
TV-22G	292
TV-23	134
TV-23D	134
TV-23G	292
TV-24G	292
TV-25G	292
TV-26G	292
TV-27G	292
TV-30	134
TV-31	134
TV-32	134
TX-1	138
TX-3D	138
TZ-1	135
TZ-1D	135

U

U- 1D	138
U- 1G	345
U- 1G NIQ	345
U- 1I	138
U- 1X	253
U- 2D	138
U- 2I	138
U- 3D	138
U- 3I	138
U- 4AD	139
U- 4AI	139
U- 4D	138
U- 4I	138
U- 4JD	139
U- 4JI	139
U- 4TD	139
U- 4TI	139
U- 5AD	139
U- 5AI	139
U- 5BD	139
U- 5BI	139
U- 5CD	139
U- 5CI	139
U- 5D	139
U- 5DD	139

REF.	PAG.
U- 5DI	139
U- 5DSP	140
U- 5ED	139
U- 5EI	139
U- 5FD	139
U- 5FI	139
U- 5I	139
U- 5JD	139
U- 5JI	139
U- 5KD	139
U- 5KI	139
U- 5MD	140
U- 5MI	140
U- 5PD	140
U- 5PI	140
U- 5QD	140
U- 5QI	140
U- 5SD	140
U- 5SI	140
U- 5SP	140
U- 5TD	140
U- 5TI	140
U- 5VD	140
U- 5VI	140
U- 5XD	140
U- 5XI	140
U- 5YD	140
U- 5YI	140
U- 6BD	140
U- 6D	140
U- 6GD	140
U- 6I	140
U- 7	141
U- 7D	141
U- 8	141
U- 8D	141
U- 8PD	141
U- 8TD	141
U- 9	141
U- 9D	141
U-10D	141
U-10I	141
U-13D	141
U-13I	141
U-14D	141
U-14I	141
U-15	141
U-15D	141
U-15GD	141
U-15GI	141
U-16	141
U-16D	141
U-17	141
U-17D	141
U-18D	142
U-19	142
U-19D	142
U-21	142
U-21D	142
U-22	142

REF.	PAG.
U-22D	142
U-25	142
U-25D	142
U-26	142
U-26D	142
U-26GD	142
UCEM- 1D	135
UCEM- 1G	292
UCEM- 1I	135
UCEM- 2D	135
UCEM- 2G	292
UCEM- 2I	135
UCEM- 3	135
UCEM- 3G	292
UCEM- 4I	135
UCEM- 5D	136
UCEM- 5I	136
UCEM- 7D	136
UCEM- 7I	136
UCEM- 8D	136
UCEM- 8DP	136
UCEM-12	135
UCEM-13D	136
UCEM-17D	136
UL-1	136
UL-2D	136
UL-3	136
UL-4	136
UMF-1	136
UN- 1FS	137-234
UN- 1G	292
UN- 2	137-234
UN- 3	137-234
UN- 4	234
UN- 5D	137
UN- 6D	137
UN- 7D	137
UN- 7I	137
UN- 8D	137
UN- 8I	137
UN- 9D	138
UN- 9I	138
UN-10D	138
UN-10I	138
UN-11	138
UN-12I	137
UN-13D	137
UN-13I	137
UN-14D	137
UN-14I	137
UN-15D	137
UN-15I	137
UN-16D	137
UN-16I	137
UN-17D	137
UN-17I	137
UN-18D	137
UN-18I	137
UN-19D	137
UN-19I	137

REF.	PAG.
UN-20D	137
UN-20I	137
UN-21D	137
UN-21I	137
UN-22D	137
UN-22I	137
UN-23D	137
UN-23I	137
UN-24D	137
UN-24I	137
UN-25D	137
UN-25I	137
UN-26D	137
UN-26I	137
UN-27D	137
UN-27I	137
UN-28I	137
UN-29D	137
UN-29I	137
UN-30D	137
UN-30I	137
UN-31D	137
UN-31I	137
UN-32D	137
UN-32I	137
UN-33D	137
UN-33I	137
UN-34D	137
UN-34I	137
UN-35D	137
UN-35I	137
UN-36D	137
UN-36I	137
UN-37D	137
UN-37I	137
UN-38D	137
UN-38I	137
UN-39D	137
UN-39I	137
UN-40D	137
UN-40I	137
UN-41D	137
UN-41I	137
UN-42D	137
UN-42I	137
UN-43D	137
UN-43I	137
UN-44	137-234
UN-44D	137-234
UN-45D	138
UN-46D	138-234
UN-47	138
UN-FFE	137-234
UN-FK	138-234
UN-FP	137-234
UN-FR	137-234
UN-FS	138-234
UN-FT	234
UN-MRN	137-234
UN-NC	234

REF.	PAG.
UN-NG	137-234
UN-NH	234
UN-NHP	234
UN-TF	234
URB-1	142
URB-1D	142
URB-2	142
URB-3D	142
URB-4D	142
URKO-1D	142
URKO-1I	142
URKO-2D	142
URKO-2I	142
URKO-3D	142
URKO-3I	142
URKO-4	142-349

V

V-1G	345
V-1G(CV)	345
V-2G	345
V-2G(CV)	345
V-3G	345
V-3G(CV)	345
V-4G(CV)	345
V-5G(CV)	345
VA- 1	143
VA- 2	143
VA- 3	143-235
VA- 3I	143-235
VA- 4	143
VA- 4D	143
VA- 5	143
VA- 6	235
VA- 6P	235
VA- 7	235
VA- 8D	143
VA- 9D	144
VA-10	144-235
VA-11	145
VA-12D	144
VA-13D	143
VA-13I	143
VA-14D	144
VA-15	144
VA-16	235
VA-17P	235
VA-18	235
VA-19	143
VA-20	143
VA-21	143
VA-22	143
VA-23	143
VA-24D	144
VA-24I	144
VA-25	144
VA-26	144
VA-27	144
VA-28	144
VA-29	144

REF.	PAG.	REF.	PAG.	REF.	PAG.	REF.	PAG.	REF.	PAG.
VA-29D	144	VA-RH	143	VO -FHP	195	WE-5D	149	WIL-50D	150
VA-30	144	VA-RHM	143	VO -FHP1	195	WE-5I	149	WIL-51D	150
VA-31D	144	VA-RJ	143	VO -HV	195	WE-6D	149	WIL-52	150
VA-32D	144	VA-RK	143	VO -HVP	195	WEB-1	149	WIL-53	150
VA-33D	144	VA-RL	143	VO -K	195	WEB-2	149	WIL-54	150
VA-34	235	VA-RM	143	VO -L	195	WEB-3	149	WIL-55	150
VA-34P	235	VA-RN	143	VO -M	195	WEI-1	149	WIL-56	150
VA-34P1	235	VA-ROK	143	VO -MP	195	WEI-2	149	WIL-57D	150
VA-35	144	VB-1D	146	VO -N	195	WEI-3	149	WIL-58D	150
VA-35D	144	VB-2D	146	VO -NP	195	WEI-4	149	WIL-59D	150
VA-36	145	VE-1D	146	VO -R	195	WEI-5	149	WIL-60D	150
VA-37	145	VG-1D	148	VO -RP	195	WEI-6	149	WIL-61	150
VA-38	145	VGf-4D	147	VO -VA	195	WES-1D	149	WIL-62	150
VA-39	145	VGf-4I	147	VO -VAP	195	WHI-1D	150	WIL-63D	150
VA-40	145	VGf-5D	147	VO -VB	195	WIL- 1D	150	WIL-65D	150
VA-41	145	VGf-5I	147	VO -VBP	195	WIL- 2D	150	WIN- 1D	151
VA-42	145	VI- 1D	147	VO -VBP1	196	WIL- 3D	150	WIN- 1I	151
VA-43	145	VI- 1I	147	VOL-1	236	WIL- 4D	150	WIN- 2D	151
VA-44	145	VI- 2D	147	VOL-1P	236	WIL- 5	150	WIN- 3D	151
VA-45	145	VI- 2I	147	VOL-2	236	WIL- 5D	150	WIN- 4D	151
VA-46	145	VI- 4D	147	VOL-2D	236	WIL- 7	150	WIN- 5	151
VA-47	145	VI- 4DP	147	VOL-3	236	WIL- 8	150	WIN- 5D	151
VA-48	145	VI- 4I	147	VOL-4	236	WIL- 9	150	WIN- 6D	151
VA-49	145	VI- 4IP	147	VOL-5P	236	WIL-10	151	WIN-21	151
VA-50	145	VI- 5D	147	VW-K70	196	WIL-11	151	WIN-22	151
VA-51	145	VI- 6D	147			WIL-12	151	WIR-1	151
VA-52	145	VI- 7	147	W		WIL-13	151	WIT-1	237
VA-53	145	VI- 8	147	WA-1D	148	WIL-14	151	WM-1D	152
VA-54	145	VI- 8D	147	WA-4D	148	WIL-15	151	WM-1G	292
VA-55	145	VI- 9D	147	WA-4I	148	WIL-16	151	WM-2D	152
VA-56	144	VI-10	148	WA-5D	148	WIL-17D	151	WM-3D	152
VA-57	145	VI-11	148	WA-5DP	148	WIL-18	150	WM-4D	152
VA-58	145	VI-11D	148	WA-5I	148	WIL-19D	150	WM-5D	152
VA-59	145	VI-12	147	WA-5IP	148	WIL-20	151	WNC-1	151
VA-60	145	VI-14	148	WAL-1D	148	WIL-22	151	WST-1D	150-237
VA-61C1	235	VI-15	147	WAL-2D	149	WIL-24	150	WST-2D	150-237
VA-61C2	236	VI-16D	148	WAN-1D	149	WIL-25	150	WT-1	152
VA-62	144	VILL-1G	333	WAS - 1	236	WIL-26	150		
VA-62D	144	VIN-1D	147	WAS - 2P	236	WIL-27	150		
VA-70	145	VLK-1	148	WAS - 3	237	WIL-28	150	Y	
VA-75D	143	VLK-2	148	WAS - 3P	237	WIL-29	150	YA- 1D	152
VA-DHP	143	VND-1	146	WAS - 4	237	WIL-30	150	YA- 1G	327
VA-LA	143	VND-1D	146	WAS - 4P	237	WIL-31D	150	YA- 1I	152
VA-LB	143	VND-2	146	WAS - 5	237	WIL-32	150	YA- 1X	253
VA-LC	143	VND-2D	146	WAS - 5P	237	WIL-33D	150	YA- 2D	152
VA-LD	143	VND-3	147	WAS - 6	237	WIL-34D	150	YA- 2G	327
VA-LE	143	VO -1	194	WAS - 6P	237	WIL-35D	150	YA- 2I	152
VA-LF	143	VO -2	194	WAS - 7D	237	WIL-36D	150	YA- 2X	254
VA-LG	143	VO -2DP	194	WAS - 7I	237	WIL-37D	150	YA- 3D	152
VA-LH	143	VO -2DP1	194	WAS - 8	237	WIL-38D	150	YA- 3G	327
VA-LN	143	VO -2P	194	WAS - 8D	237	WIL-39D	150	YA- 3I	152
VA-RA	143	VO -2P1	194	WAS - 9	237	WIL-40D	150	YA- 3X	254
VA-RB	143	VO -5P	194	WAS - 9D	237	WIL-41D	150	YA- 4G	327
VA-RC	143	VO -6D	194	WAS -10DP	237	WIL-43D	150	YA- 4X	254
VA-RD	143	VO -7	174	WAS -10P	237	WIL-44	150	YA- 5D	152
VA-RDH	143	VO -8P	194	WBS-1	149	WIL-45D	150	YA- 5G	292
VA-RDM	143	VO -8P1	194	WE-1G	326	WIL-46D	150	YA- 5I	152
VA-RE	143	VO -AH	195	WE-2G	326	WIL-47D	150	YA- 5X	254
VA-RF	143	VO -AHP	195	WE-4D	149	WIL-48D	150	YA- 6D	152
VA-RG	143	VO -FH	195	WE-4I	149	WIL-49D	150	YA- 6I	152
								YA- 6X	254

ÍNDICE GENERAL

GENERAL INDEX

REF.	PAG.	REF.	PAG.	REF.	PAG.	REF.	PAG.	REF.	PAG.
YA- 7D	152	YA- 58	154	YAMA- 7I	238	YET- 3D	156	ZE- 7D	75
YA- 7I	152	YA- 58D	154	YAMA- 8D	238	YET- 4	156	ZE- 7X	255
YA- 8D	152	YA- 59	154	YAMA- 8I	238	YET- 4D	156	ZE- 8	75
YA- 8I	152	YA- 59D	154	YAMA- 9D	238	YET- 5	157	ZE- 8X	255
YA- 9I	152	YA- 72	155	YAMA- 9I	238	YET- 5D	157	ZE- 9D	74
YA- 10	153	YA- 79D	155	YAMA-10D	239	YET- 6	157	ZE- 9X	255
YA- 10D	153	YA- 81	155	YAMA-10I	239	YET- 6D	157	ZE- 10D	76
YA- 11D	153	YA- 85D	155	YAMA-11D	239	YET- 7	157	ZE- 11D	76
YA- 11I	153	YA- 88	155	YAMA-11I	239	YET- 7D	157	ZE- 13	76
YA- 12D	153	YA- 89	155	YAMA-12D	239	YET- 8	157	ZE- 14D	74
YA- 12I	153	YA- 91	154	YAMA-12I	239	YET- 8D	157	ZE- 15	75
YA- 13D	153	YA- 91D	154	YAMA-13D	239	YET- 9	157	ZE- 16D	75
YA- 13I	153	YA- 92	154	YAMA-13I	239	YET- 9D	157	ZE- 17D	75
YA- 14D	153	YA- 92D	154	YAMA-14D	239	YET- 10	157	ZE- 18D	75
YA- 14I	153	YA- 93	154	YAMA-14I	239	YET- 10D	157	ZE- 19	75
YA- 15D	153	YA- 94	154	YAMA-15D	239	YET- 11	157	ZE- 20	75
YA- 15I	153	YA- 95	154	YAMA-15I	239	YET- 11D	157	ZE- 21D	75
YA- 16D	152	YA- 97D	155	YAMA-16D	239	YET- 12	157	ZE- 22	75
YA- 17D	153	YA- 98D	155	YAMA-16I	239	YET- 13	157	ZE- 23D	76
YA- 17I	153	YA- 99D	155	YAMA-17D	239	YET- 14	156	ZE- 24D	76
YA- 18D	237	YA- 100D	155	YAMA-17I	239	YET- 14D	156	ZE- 25D	76
YA- 19D	238	YA- 101D	155	YAMA-18D	239	YET- 15	156	ZE- 26D	76
YA- 20D	238	YA- 102D	155	YAMA-18DP	239	YET- 16	156	ZE- 27D	76
YA- 20I	238	YA- 103D	155	YAMA-18I	239	YET- 17D	157	ZE- 28D	76
YA- 21D	238	YA- 108	155	YAMA-18IP	239	YU- 1D	240	ZE- 29D	76
YA- 21I	238	YA- 111	155	YAMA-19D	239	YUH- 1D	157	ZE- 30D	76
YA- 22D	153	YA- 112	155	YAMA-19DP	239	YUH- 2D	157	ZE- 31D	76
YA- 22I	153	YA- 113	155	YAMA-19I	239	YW- 1P	157-240	ZE- 32D	76
YA- 23	153	YA- 142D	155	YAMA-19IP	239			ZE- 33D	76
YA- 24D	153	YA- 186D	155	YAMA-20D	239	Z		ZE- 34D	76
YA- 24I	153	YA- 206D	155	YAMA-20DP	239	ZA- 1	157-240	ZE- 35	77
YA- 25D	153	YA- 208D	155	YAMA-20I	239	ZA- 1P	158-240	ZE- 35D	77
YA- 25I	153	YA- 209D	155	YAMA-20IP	239	ZA- 2P	240	ZE- 36D	75
YA- 26I	153	YA- 210D	155	YAMA-21I	239	ZA- 3D	240	ZE- 37D	75
YA- 27	153	YA- 212D	155	YAMA-21IP	239	ZA- 4DP	240	ZE- 38	75
YA- 27D	153	YA- 216	156	YAMA-22DP	239	ZA- 5DP	241	ZE- 39	75
YA- 28	154	YA- 217	156	YAMA-22IP	239	ZA- 5P	241	ZE- 40D	75
YA- 28D	154	YA- 219	156	YAMA-23DP	239	ZA- 6DP	241	ZE- 41	75
YA- 29	153	YA- 220	156	YAMA-23IP	239	ZA- 6DP1	241	ZE- 42	75
YA- 30	154-349	YA- 221	156	YAMA-24DP	239	ZA- 7DP	241	ZE- 43	75
YA- 31D	154	YA- 225	156	YAMA-24IP	239	ZA- 8P	241	ZE- 44D	75
YA- 32D	152	YA- 226	156	YAMA-25DP	240	ZA- 9P	241	ZE- 45D	75
YA- 33D	154	YA- 227	156	YAMA-26	240	ZA- 9P1	241	ZE- 46	75
YA- 34D	154	YA- 228	156	YAMA-26D	240	ZA- 10	241	ZE- 47D	76
YA- 36D	154	YA- 229	156	YAMA-26DP	240	ZA- 12	158-241	ZE- 48D	76
YA- 37	154-238	YA- 232	156	YAMA-26P	240	ZA- 13P	241	ZE- 49D	76
YA- 37D	154-238	YA- 272D	155	YAMA-27	240	ZE- 1	74	ZE- 50D	76
YA- 38D	154	YA- 273D	156	YAMA-27D	240	ZE- 1D	74	ZE- 51D	76
YA- 39	153	YAMA- 1D	238	YAMA-27DP	240	ZE- 1X	254	ZE- 52D	76
YA- 39D	153	YAMA- 1I	238	YAMA-27P	240	ZE- 2	74	ZE- 53D	76
YA- 46D	154	YAMA- 2D	238	YAMA-28P	240	ZE- 2D	74	ZE- 54D	76
YA- 50	154	YAMA- 2I	238	YAMA-29P	240	ZE- 2X	254	ZE- 55D	76
YA- 50D	154	YAMA- 3D	238	YAMA-30P	240	ZE- 3X	254	ZE- 56D	76
YA- 51	154	YAMA- 3I	238	YAR- 1	156	ZE- 4X	254	ZE- 57D	76
YA- 51D	154	YAMA- 4D	238	YAR- 2	156	ZE- 5D	75	ZE- 58D	76
YA- 52D	154	YAMA- 5D	238	YAR- 3	156	ZE- 5I	75	ZE- 59D	76
YA- 53	154	YAMA- 5I	238	YET- 1	156	ZE- 5X	254	ZE- 60D	76
YA- 53D	154	YAMA- 6D	238	YET- 1D	156	ZE- 6	74	ZE- 61D	76
YA- 57	154	YAMA- 6I	238	YET- 2	156	ZE- 6D	74	ZE- 62D	76
YA- 57D	154	YAMA- 7D	238	YET- 2D	156	ZE- 6X	254	ZE- 63D	76

REF.	PAG.
ZE-64D	76
ZE-65D	76
ZE-66D	76
ZE-67D	76
ZE-68D	76
ZE-69D	76
ZE-70D	76
ZE-71D	75
ZE-72	75
ZE-73	75
ZE-74	75
ZE-75	75
ZE-76D	75
ZE-77D	75
ZE-78D	75
ZE-79	75
ZE-80	75
ZE-81	75
ZE-82	75
ZE-83	75
ZE-84	75

REF.	PAG.
ZE-85	75
ZE-86D	75
ZE-87	75
ZE-88	75
ZE-89	75
ZE-90	75
ZE-91D	75
ZE-92D	75
ZE-93D	75
ZE-94D	75
ZE-95D	75
ZE-96D	75
ZE-97D	75
ZE-98	75
ZE-99	75
ZE-100	75
ZE-101	75
ZE-102	75
ZE-103	75
ZE-104D	75
ZE-105D	76

REF.	PAG.
ZE-106D	76
ZE-107D	76
ZE-108D	76
ZE-109D	76
ZE-110D	76
ZE-111D	76
ZE-112D	76
ZE-113D	76
ZE-114D	76
ZE-115D	76
ZE-116D	76
ZE-117D	76
ZE-118	75
ZE-119D	75
ZE-120	75
ZE-121D	75
ZE-122D	75
ZE-123D	75
ZE-124	75
ZE-125D	76
ZE-126D	76

REF.	PAG.
ZE-127D	76
ZE-128	75
ZE-129D	75
ZE-130	75
ZE-131	75
ZE-132D	75
ZE-133D	75
ZE-134	75
ZE-135D	75
ZE-136D	76
ZE-137	75
ZE-138	75
ZE-139D	75
ZE-140	75
ZE-141D	76
ZE-142	75
ZE-143	75
ZE-144D	75
ZE-145D	76
ZE-146D	76
ZE-147D	76

REF.	PAG.
ZE-148D	76
ZE-149	75
ZE-150	75
ZE-151D	75
ZE-152D	75
ZE-153D	75
ZE-154D	75
ZE-155D	75
ZE-156	75
ZE-157	75
ZE-158	75
ZE-159D	77
ZE-K1	77
ZE-K2	77
ZE-K5	77
ZE-K6	77
ZE-N1	77
ZEN-1D	158
ZI-1	241



Tél. 04 73 84 84 94
info@palserviceminute.com

ÍNDICE DE MARCAS

MARKEN AURKIBIDEA

BRAND INDEX

INDEX MARQUE

HAUPTMARKE



Tél. 04 73 84 84 94

info@palserviceminute.com

THE KEY TO EXCELLENCE
GLOBALLY UNLOCKING MILLIONS OF DOORS DAILY

ÍNDICE DE MARCAS

MARKEN AURKIBIDEA • BRAND INDEX • INDEX MARQUE • HAUPTMARKE

MARCA- MARKA- MAIN MARQUE - MARKE	PÁG. - ORRIA - PAGE - PAGE - SEITE
45	1
126	283
303	1
333	1
3M	1
4TR	326
A	
A.M. BARAS	1
ABA	1
ABBES	88,202
ABC	1,2
ABLOY	2
ABSA	2,3,31,113,160,222
ABT	147
ABUS	3,4,5,6,7,14,26,37,38,39,62,65,74,81,105,112,132,147,15 3,157,160,240,330
ACE	36
ADAMSRITE	7
ADEMCO	36,154,238
AEP	7
AGA	7,8,9,18,30,36,283,330,334,339,340
AGB	9,289
AGC	9,246
AGE	9,1
AGUEDA	127
AGUIA	10
AGUT	10
AHRAM	10
AIZPUTE	10
AKARSAN	293
AKIRA	156,157
AKS	161,185,186,188,189,194,195
AL	11
ALA	39,246
ALDRIDGE	10
ALE	10
ALEDAL	330
ALFA	8,11,66
ALIANCA	11
ALLGOOD	32
ALPHA	11,36,161
ALSO	82
ALTAY	11
ALUNORM	41
AM	101
AMARU	11
AMERICAN LOCK	12
AMERICAN MOTORS	20,82,161,162
AMIG	12,13
ANA	252
ANCHOR	3,4,5,6,12,13

MARCA- MARKA- MAIN MARQUE - MARKE	PÁG. - ORRIA - PAGE - PAGE - SEITE
ANKE	29
ANKER	13
ANKERSLOT	12,91
ANLO	69
ANTAR	13,113,114
ANTONIOLI	293
APEX	13,14
APRI	100
ARCU	14,48,330,331,332
AREL	14
ARES	334,335
ARFE	3,14,44,111,160,334
ARMAN	174,179,180,236
ARMOR	113,222
ARMSTRONG	5,14
ARNOU	32
AROUCA	14
ARREGUI	3,8,14,31,55,62,160
ARROW	14
ARSENEVSK	15
ARTEB	226
ASEC	10
ASHICO	15
ASIA	15,156,157
ASPA	15
ASSA	15,16,17,115,126,161,283,284,293,332
ASSA ABLOY	155
ASTRAL	38
ATAL	88,89,143,202
ATL	28
ATLANTIC	64
ATLAS	125
ATP	31
ATRA	46,79,293,294
AUMON	17,44
AUNO	293
AUTOBLOCK	226
AVA-CHUBB	36
AVANGARD	17
AXA	161,162
AXIS	38
AYPE	332
AZBE	17,18,151
AZKOYEN	18
AZU	162
B	
B+D	18
BAB	19,43,54,113
BAGEM	1,2,19
BALING LOCK	125
BALTIKA	20
BANE SEKULIC	26,27,142
BANHAM	20

ÍNDICE DE MARCAS

BRAND INDEX

MARCA- MARKA- MAIN MARQUE - MARKE	PÁG. - ORRIA - PAGE - PAGE - SEITE
BAODEAN	20
BARCZ	20
BARIER	20
BARRO	47
BASCO	20,162,200
BASI	20
BASTA	20,21,95,214,240
BATU	21,38,74
BAU	143
BELL	156,157
BENCO	127
BENDIX	153,154,238
BERAM	147
BERRY	22,23,33
BERTOLOTTI	128
BEST	21
BETA	21,294,295
BEY	21
BIBERING	21,22,130
BIELLE	22
BIFFAR	22
BILMA	22
BIRD	63,152
BKS	22,23,24,63,91,152,153,155,156,253,254
BLACK & DECKER	43
BLAU	162,182
BLOCK	227
BLOCTOUT	26
BLOCUS	110,111,113
BLOSTER	224
BLUMA	246
BMB	24
BMC	295
BMH	340
BODA	24,33,34,284,295,323
BOGATIR	295
BOINAITI	289
BOMBARDIER	163
BOMORO	25,146,163,217
BONAITI	262
BÖRKEY	25
BOSCH	163,189,217
BOULTON & PAUL	25
BOXAFE	295
BRABANTIA	25,40,54,99,163,166
BRAS	25
BRASIL	25
BRETER	157,158,240,241
BRICARD	4,25,26,38,86,92,116,246,284
BRIGGS & STRATTON	20,162,163,164,166,175,176,177,178
BRITAX	174,204
BRUMME	26,74,75
BSS	26,27
BTV	20,27,46,47,123,124,315
BUFFO	4,5,6,160
BUGA	27
BULAT	27,28
BULIT	3,82
BURG	4,5,28,29,30,43,77,106,114,147,164,223,246,247,335

MARCA- MARKA- MAIN MARQUE - MARKE	PÁG. - ORRIA - PAGE - PAGE - SEITE
BURG WACHTER	28,29,313
BURGHOWT	127
BUS	30
BUVA	28,3
BWS	41
BY	31
BYP	13,78
C	
C.A.R.S.	107
C.V.C.	13
CAB	30,31,153
CAF	296
CAM	323
CAM LOCK	30
CAMA	164
CAMBOA	41
CAP	31,11,111
CARAT	63,152
CARTERO	30,31
CAS	57
CAS CISMA	31,101,340
CASAS	8
CASELLAS	164
CASH BOX	31,99
CASI	117,174,175,185,186,188,191,192,194,195
CASMA	33,35
CATERPILLAR	164
CATOR	114
CAVERS	18,31,32,121
CAYS	32,44,124
CAZORLA	44
CC	127
CCF	247,248
CCL	42
CEKA	72
CEM	92,93,164,165,174,175,203,204,234
CEMA	32
CENTURION	18
CENTURY	32
CERRAMARC	32
CERUTTI	296,297,332
CES	33,34,35
CESSNA	165
CF	63,319
CFP	150
CHANGE-O-MATIC	42
CHAVO	6,36,38,39
CHELIABINSK	36
CHEYLOCK	36
CHG	65
CHICAGO	20,36,153,154,162,238
CHRIST	47
CHRYSLER	165,166
CHUBB	36,284,297
CIB	63,107,110,111,135
CIBC	63
CIBOX	28
CIEF	36
CIELS	36

MARCA- MARKA- MAIN MARQUE - MARKE	PÁG. - ORRIA - PAGE - PAGE - SEITE
CIFIAL	37,248
CILA GENTILI	37
CINA	15,37,52,119
CISA	3,4,5,6,37,38,39,92,141,298,299
CITY	31,32,63
CLARK FORK LIFT	40
CLASS	299
CLASSIC	40
CLAUSOR	40,99,165,166,167,174,175,179,189,209,210,211,212,213, 214,216,217,226,228
CLEMSA	40
CLICK	167
CLUM	167
COBRA	167,168
CODEM	63
CODKEY	121
COFER	98
COHNKO	40
COLE HERSEE	153
COLOMENCA	8
COM	40
COMBA	33,85,130
CORBIN	41,42,43,48,49,50,162
CORNI	127,289,300
CORONA	43,44,77
CORSA	126
COTICO	44
COUILLET	112
CR	254,300, 301
CRAIN	90
CRAZY LOCKS	44
CRC	41
CRC CAMBOA	248
CROMODORA	224
CRONOS	335
CUBELLS	44
CVL	44
CWS	47
D	
DACIA	168
DAD	44,46,47,62,124,144
DAELIM	168
DAEWOO	168,169
DAF	45
DAIHATSU	169
DAMM	22,23
DAR-MAR	285
DARMIX	169
DATSUN	213,218,219,220
DAV	169
DC	113
DEBEAURAIN	70,113,136,248,285
DECAYEUX	44,107,112
DEFA	45
DEHA	156,157
DEKABA	45,302
DELAPORTE	45,46
DELCA	46

MARCA- MARKA- MAIN MARQUE - MARKE	PÁG. - ORRIA - PAGE - PAGE - SEITE
DELTA	113
DERLOCHE	113
DESAL	29
DESPREZ	113
DEXTER	46,163
DIAMOND	46
DIEBOLD	46,349
DIERRE	46,98
DIFA	114
DIMITROVGRAD	46
DIRAK	45
DJC	127
DKW	162
DNS	71
DOBLE G	169
DOBLE SAFE	93,94,203
DOBLINA	169
DOCO	43
DOM	41,46,47,48,49,50,51,102,103,124,169,170,174,194,227, 236
DOMINION LOCK	14,51
DOMUS	31,51,52,311
DONNER	127
DOOR LOCK	248
DOUBLE CIRCLE	52
DRAPER	155
DUBOIS	88,89,170,202
DUPLEX	335
DURABLE	28
DURALOCK	52
DVERNIAK	302,303,335,336
E	
EAG	52
EAGLE	52,71
EAO	49
ECHO	170
ECM	52
EFER	37
EIKO	52
ELBOR	303
ELCA	55,56,127
ELEPHANT	133
ELFIN	32
ELMO	20,162
ELSET	99
ELZETT	33,53,285, 286,304
EMGE	113
EMHART	48,49, 50, 113, 222
EMKA	45,53, 54
EMOH	162
ENA OQ	135
EP PINSON	53
EPO	117
EQUIBATIR	113
ERA	53,54, 286
EREVAN	304,336
ERINRUDE	222
ERMEX	126

ÍNDICE DE MARCAS

BRAND INDEX

MARCA- MARKA- MAIN MARQUE - MARKE	PÁG. - ORRIA - PAGE - PAGE - SEITE
ESA	54,286
ESAFE	36,46, 47, 98, 124, 127, 136, 139
ESCO	6,38, 39, 41, 42, 127
ESETY	304,305
ESLA	54
ESS	54
ESSENDIA	6,38, 39
ESZ	80
ETAS	54
ETNA	31,109
EUREKA	54
EURO	44
EURO BOX	54
EURO LOCKS	21,36, 54, 55, 92, 93, 94, 170, 203, 204
EURO PRO	148
EURO SPEC	138
EURONORM	41,42
EUROP	125
EUROPARTNER	41
EUROPROFIL	67
EUROTEMPLE	305,306
EVERGOOD	55,12
EVVA	55,56
EXCEL	56
EXPRES	56,65, 91, 92, 157
EZCURRA	56,57, 117, 118, 306, 307
EZSET	86
F	
FAAB	170
FAB	57,69, 170,171
FAC	7,30, 31, 58, 59, 84, 124, 127, 146, 307
FACEF	311
FADE	74,112
FAI	148
FAICA	171
FAINER	59
FALCON	21,59,149
FAMA	59
FANA	26,59
FARMA	171
FAS	59
FAS - YALE	286,287
FASEM	22,59
FASMA	55
FAVOUR	59
FAYN	60,248
FB	8
FCV	60,85
FEB	11,36, 82, 109, 161, 307
FECHADURA	60
FECOR	46, 47, 334
FEDERAL	60, 64, 65
FEFI	33
FEL	119
FEMSA	171
FERMABLOCK	106
FERMOD	44
FERONERIA	60

MARCA- MARKA- MAIN MARQUE - MARKE	PÁG. - ORRIA - PAGE - PAGE - SEITE
FETIS	307
FF	60,61
FH	340
FHUR	80
FIAM	248, 254, 308, 309
FIAT	171
FIC LOCKS	61
FICHET	22, 61, 88, 130, 149, 287, 310
FINSTRAL	66
FISAM	171
FIST	62, 164, 171, 179, 223, 224
FLAMBO	50, 170
FLIETHER	85
FLIK	65
FLOHR	62
FLORA	62, 162, 171
FO	31, 32, 103
FONTAINE	62, 113, 143
FORCE	68
FORD	171, 172, 173, 174, 175
FORINDEX	113,222
FORT	14, 36, 62, 77, 154, 162, 238
FORTE	62
FORTIS	63
FORTRESS	127
FOUR CIRCLE	156, 157
FPB	109
FRAL	109
FREA	224
FRECOV	33
FRIPA	63, 249
FROSER	3, 113, 160, 222
FT	70
FTH	3, 13, 63, 64, 65, 72, 129
FUCHS	41
FUHR	33
FULLEX	65
G	
GABON	65
GAINSBOROUGH	92,127
GALLUS	65
GAMMA	104
GAMMET	65
GAON	84
GARDIAN	310
GARI	8
GAS	175
GATO	65
GAZ	236
GBS	150
GBZ	65
GE GE	6, 11, 27, 65, 66, 123
GEBA	22, 23, 66
GEBRO	43
GEFI	6, 38, 39
GELBAU	127
GELBON	202, 203
GEM	36

MARCA- MARKA- MAIN MARQUE - MARKE	PÁG. - ORRIA - PAGE - PAGE - SEITE
GEMINI	82
GEMM	87, 88
GENERAL MOTORS	175, 176, 177, 178
GERA	66, 67, 117, 249
GERDA	67
GETE	6,38,39
GEVY	20,46
GEWIRU	51
GEWU	178
GHE	178
GIBBONS	67
GIESCHE	33,85
GIMAST	310
GIMN	113
GIObERT	167, 179, 180, 181, 182, 224, 234
GIPIS	310
GIUSSANI	67,68
GLAZIEV	68
GLOBE	68,69
GLOSTAL	65
GMB	12
GMG	310
GODREJ	69
GOLD DOOR	68, 69
GOLLOT	113
GOTZ	85
GOYAL	8
GPZ	287
GR	69
GRAF	85
GRAYHILL	77
GRUNDMANN	65
GSA	31
GTV	6, 38, 39, 69, 80
GUARD	69, 70, 74
GUARDIAN	31, 60, 288
GUERVILLE R.	70
GUIDOTTI	113
GUITTEL	4, 5
GUTLER	119
H	
HÄFELE	33, 34, 46, 47, 70, 72, 88, 89, 202
HAGA	70
HAIDE	156, 157
HALLE	70
HAMA	182
HAMPTON	132
HANNO	33
HARKOV	71
HARLEY DAVIDSON	182
HARLOC	71, 127
HASLER	117, 118
HAYWORTH	71
HB	71
HBC	100
HEAD	156, 157
HEGO	41
HEKNA	46, 47, 50, 71

MARCA- MARKA- MAIN MARQUE - MARKE	PÁG. - ORRIA - PAGE - PAGE - SEITE
HELCO-KFV	249
HELIX	71
HEMA	143
HEMY	156, 157
HENDERSON	71, 288
HERACLES	64
HERME	71
HERMES	156, 157
HERO	106
HERPE	127
HERSEE	20, 162
HESTE	41
HEVY	28
HILLMANN	128
HINO	233
HK	162
HOBBY	55, 170
HOBES	72
HOHRMANN	22, 23, 33, 47, 65
HONDA	182, 183, 184, 185
HOPPE	28
HORSE	72
HRG	106
HSA	85
HTEC	72
HTV	72, 119
HUDSON	72, 185
HUF	168, 172, 174, 185, 186, 187, 188, 189, 190, 191, 192, 193, 194, 195, 196
HUNIT	72
HUTRA	117
HUWIL	46, 47, 72, 73, 196
HYMER	55, 170
HYUNDAI	196, 197, 198
I	
I.R.	152
IACAM	180
IBEAR	73
ICA	73
ICSA	73, 90
IDEAL	47
IDEAL SECURITY	149
IDM	311
IFAM	18, 43, 63, 64, 73, 74, 78, 124
IFOS	126, 127
IGS	74
IKON	43, 44, 74, 75, 76, 77
ILARGI	32, 77
ILCO	77
ILLINOIS	20, 36, 77, 154, 162, 238
ILS	77
IMB	77
IMBAC	111
IMP	3, 4, 5
IMSA	191, 198, 199, 224
INCECA	78
INDAK	229
INDAUX	14

ÍNDICE DE MARCAS

BRAND INDEX

MARCA- MARKA- MAIN MARQUE - MARKE	PÁG. - ORRIA - PAGE - PAGE - SEITE
INGERSOLL	78
INLOC	26
INSTALL	127
INT	78
IR	78
ISEO	3, 32, 78, 79, 110, 136, 143, 235, 249, 289, 309, 311, 312
ISKU	106
ISSERSTEDT	41
ISUZU	199
ITAL	312
ITEM	29
ITO	6, 38, 39, 79
IVANA	79

J

JARDI	79, 80
JD	11, 114, 161
JET	3
JINLONG	80
JIP	80, 110, 111, 113
JIS	80, 84
JJ	44
JL	63
JMP	3, 6, 38
JOHN DEERE	199
JOMA	31, 73, 74, 80, 120
JORE	150
JOSTA	33
JOVI	7, 80
JOWIL	69, 80, 81
JPM	3, 81, 85
JTF	81
JU	89, 144, 202
JU JUNGINGER	82
JUGODENT	174
JUNGHEINRICH	82
JUNGST	80
JUNIE	82
JUNKUNC	82
JUWEL	313
JUZU	82
JVAL	82

K

K+K	98
KABA	82, 83
KABS	83
KALE	3, 83, 84, 313
KALUGA	84
KAMAZ	199
KAP	84
KARDEX	33, 113, 222
KARO	64
KASSBOHRER	178
KASSEL	314
KATE	119
KAWASAKI	199, 200
KAWE	41, 42, 127, 149
KAZAN	84, 85
KEMEN	7, 8, 106

MARCA- MARKA- MAIN MARQUE - MARKE	PÁG. - ORRIA - PAGE - PAGE - SEITE
KENWORTH	200
KERBEROS	314
KESO	85
KEYA	2, 3, 160
KFV	85
KIA	200, 201
KICHINEV	85
KIFER	7
KIFERM	85, 88, 89, 112, 165, 202, 221
KIMA	33
KIND	28, 33
KIROVMACH	86
KITTY	2
KLIT	143, 235
KN	162
KNAPP	33
KOLB	163, 172, 173, 174, 175
KOMATSU	201
KP	86
KRAMATORSK	86
KREMENCHUG	86
KREPISH	315
KRESTI	250, 251, 252
KROST	30
KUNERT	38
KURZEME	315
KVR	31
KWIKSET	86
KYMCO	201
KYNNARPS	86
KYR	118

L

LABOFA	66
LADA BAKONY	201, 202
LAFONTE	86
LAGRANDE	77
LAMA	100, 129
LAMPA	32
LANE	43
LAPERCHE	31, 86, 87, 88, 113, 114, 143
LAPORTE	25, 88, 163, 222
LAR	288, 332
LAREDO	63, 152
LARK	68, 88
LAS	88, 89, 112, 202
LASBOLAGET	82, 89, 119, 288
LEFEBURU	37
LEGALLAIS	71, 89
LEGGE	89
LEN-LOK	92
LEROY MERLIN	79
LG	14
LINCE	11, 89, 90, 161, 315
LINDE	162
LION	82
LIONA LIOX	113
LIPS	90, 91, 111
LISTA	47

MARCA- MARKA- MAIN MARQUE - MARKE	PÁG. - ORRIA - PAGE - PAGE - SEITE
LITTO	13, 41, 91
LM	126
LMP	202, 203
LOB	91, 92, 98, 157
LOCK	92
LOCK-IT	252
LOCKSYS	121
LOCKWOOD	92
LOGO	92, 141
LORI	71
LOTUS	156, 157
LOWE & FLETCHER	36, 55, 92, 93, 94, 95, 203, 204, 205
LT	95
LUCKY	95
LUCO	69
LUMA	95
LUME	67
LUXOR	127
LYF	96
M	
M.LUNA	2, 160
MACK	205
MACOR	336
MAFOR	113, 252
MAGNETI MARELLI	179, 224, 226
MAGNUM	96
MARCADET	88, 89, 202
MARIANI	96
MARK	133
MARQUES	96
MARS	54
MARUTI	205
MASTER	41, 96, 97
MASTER LOCK	97
MASTERCRAFT	127
MATTEY	125
MAUER	45
MAUSER	33, 72
MAVE	289
MAXIGARD	65
MAXIM	336
MAXUS	97
MAZDA	205, 206, 207
MBB	33
MCL	97
MCM	97, 98, 99, 288, 289, 315
MD	78, 79
ME FA	99
MECALUX	7, 46, 47
MECO	99
MELSMETALL	28, 99, 100
MENOVA	47
MERCURY	167
MERIT LINDE	207
MERKUR	80
MERMIER	41, 43
MERONI	100, 101
METAL	101, 315, 316

MARCA- MARKA- MAIN MARQUE - MARKE	PÁG. - ORRIA - PAGE - PAGE - SEITE
METALCASTELLI	71, 111
METALCHIMEX	127
METALUX	101, 127, 143
METEOR	22, 46, 47, 89, 101, 202
METIZ	101
METTEM	303
MG MONTI	101
MIA	323
MIAN	68
MIBRA	93, 204
MICHEL SEAT	101, 107
MIGNON	152
MILA	101, 102
MILES	102
MING TAY	102
MINI MOLA	252
MIRAGLIO	224
MISCELLANEOUS	207
MITSUBISHI	207, 208, 209
MIWA	102
MLM	46, 47, 102, 103, 113, 124, 222
MOBELLA	103
MODERN	143
MOFA	164
MOFLEX	106
MOGILEV	103
MOIA	316
MON	103
MONACOR	11, 161
MONDIAL	70, 113, 209
MONOBLOC	32, 103
MOREAUX	47, 49, 113, 148, 252
MOSKVA	289
MOSKVITCH	209
MOSRENTGUEN	103
MOTTURA	104, 316, 317, 318, 319
MP	289
MP PLODARI	104
MR	126
MSM	104
MST	31
MSV	104, 252
MUKRA	41, 42
MULTLOCK	104, 105
N	
NABOB	252
NATIONAL CABINET	105
NB	6, 38 39 62
ND	135, 136
NEIMAN	163, 165, 174, 175, 179, 180, 185, 187, 188, 194, 195, 196, 209, 210, 211, 212, 213, 214, 215, 216, 217, 218, 224, 225, 226, 235
NEMEF	33, 35, 41, 113, 222, 253, 340
NEWMAN TONKS	127
NICO	63, 85
NISSAN	218, 219, 220, 221
NOBO	47, 50, 169
NORDWEST	62, 117
NOVA	105, 132

ÍNDICE DE MARCAS

BRAND INDEX

MARCA- MARKA- MAIN MARQUE - MARKE	PÁG. - ORRIA - PAGE - PAGE - SEITE
NOVOFERM	41
NUMIDA	54, 113
O	
OAL	43, 67
OASA	289
OCARIZ	105
OCTAVO M.	105
ODA	13, 36
OFITA	105
OIAUS	9
OJMAR	33, 105, 106
OLIVA	106
OLIVETTI	107
OMA	107
OMEC	107, 319
OMIV	22, 107
OMR	101, 107
ONIUM	138
ORBA	119
ORDO	88, 107, 202
ORENGO	8, 289, 319, 333
ORION	127
ORION NOVOX	107
ORLANDO	73
ORO	108
ORONA	244
ORSHA	108
OSKO	80
OSMET	289
OSTMARK	289
OTIS	74, 75, 77
P	
P&C I.	108
PADO	108
PANTHER	80
PAPAIZ	108, 253
PAS	111
PASSEPARTOUT	289
PASSY	112
PASTORE	110, 111
PATENT	289
PATRONE	319
PAYKAN	128
PB	106
PC	22, 82, 109
PEBRA	186
PENT	136
PENZMASH	109
PERINO	289
PEROHAUS	50, 65, 66, 82, 178
PERRIER	70
PETERBORO	51
PETROZAVODSK	109
PAFFENHAIN	109, 110
PGO	221
PH	136
PHILLIPS	25, 110
PHOENIX	110

MARCA- MARKA- MAIN MARQUE - MARKE	PÁG. - ORRIA - PAGE - PAGE - SEITE
PICARD	21, 110
PICARDIE	6, 1295
PJ	89, 113, 165, 202, 221, 222
PK	89, 202
PLUS	5
PM	113
POLAR	163
POLLAK	222
POLLUX	110
POS	162, 178, 222
POTENT	101, 110, 320, 321
PP	44
PRAZIS	254
PREFER	106, 110, 111, 321, 336
PREMI	100
PRESTA	25, 163, 222
PROAUTO	3, 160
PROBAT	63
PROGRES	62
PROMO	110, 111
PROTEC	31
PZ	22, 23
Q	
QCM	44, 135
QCP	31
R	
RADIAL	144, 145
RAM	156, 157
RAUCO	71
REDY	92
REGAL	111
REGENT	71
REMO	73
RENAG	290
RENZ	46, 47, 88, 89, 111, 112, 202
REVI	321
REX	112, 290
RGM	112
RIAZIAN	112
RICOUARD	112
RIGA	112
RIGAL	322
RIL	112, 349
RIPA	74, 112
RITA	112
RITTAL	28, 29
RIV	135
ROC	63, 152
RONEO	7, 113, 146, 222
RONIS	87, 88, 113, 114, 202, 222, 223, 252
ROOL A DOOR	18
ROOTES	204
ROS	202, 203
ROSS	165, 223
ROSSETTI	114
ROTO	28, 67
ROYAL	4, 5, 114, 147, 156, 157
RS	106

MARCA- MARKA- MAIN MARQUE - MARKE	PÁG. - ORRIA - PAGE - PAGE - SEITE
RST	25
RUBEN	322, 333, 336
RUE	333
RUFFINI	224
RUKA	46, 47, 144
RUKO	114, 115
RUNO	171
RUSSIA	115
RUSSWIN	115
RUTALCHI	8
S	
SAAB	223
SAB	323
SABT	116
SADV	27, 113, 222
SAFE	182, 198, 199, 223, 224, 226, 323
SAG	305, 306, 311
SAM	116, 323
SAMSONITE	116
SANCHUN	156, 157
SANEL	113, 222
SANPEUR	145
SANTIS	33
SANTOS	107, 109
SANY	11, 161
SARGENT	116
SATURN	20, 117
SCHAFFER	222
SCHARER	117
SCHARF	72
SCHLAGE	18, 117
SCHLECHTENDAHL	117
SCHLEGEL	46, 47
SCHRITT	77
SCHUCO	3, 6, 38, 39, 85, 117
SCOVILL	18
SCUDO	9
SE	70, 127
SEA	117, 118
SECURE	122
SECUREMME	118, 323, 324
SECURIKEY	54, 100
SECURITAL	62, 118
SEEBURG	77
SEIMA	202, 203
SELECT	118
SELIVANOVSK	118
SEMEL	80, 123
SEN	85
SENTRY SAFE	118
SERMEC	324
SERRALLER	8, 44, 73, 118, 124, 337
SERRETA	118, 349
SES	127
SESA	113, 114
SEZAN	156, 157
SHANGAI	119
SHAW	119

MARCA- MARKA- MAIN MARQUE - MARKE	PÁG. - ORRIA - PAGE - PAGE - SEITE
SHILUTE	119
SHOWA	116
SIAM	31, 119
SIAS	324
SIB	32, 90
SIBI	324, 325, 337
SIDERAL	325
SIDESE	119
SIDLEEN	56
SIEBAU	33, 130
SIL	59, 120, 139
SIMATIC	119
SIMECA	67, 119
SIMPLEX	113, 222, 224, 225, 226, 235
SINJET	47
SIPEA	179, 180, 181, 224, 226
SIS	119, 120
SISO	31, 56, 106, 120
SISPA	222, 226
SJL	120
SKILMANN	42
SMET	289
SOFER	120
SOFI SONAFI	120
SOLER	120
SOLID	33
SOLOR	114
SONICO	40
SOPRANO	120
SOS	31, 65, 121, 127, 252
SP	64
SPEEDAL	33, 35
SPIDER	121
SQUIRE & SONS	121, 122
SS	33
SSANGYONG	226
STA LOCK	122
STAM	60
STANDARD	6, 38, 39
STAR	122
STARLET	122
STEELCASE	36, 72, 196
STEIGA	47
STEKLOMASH	122
STEM	123
STERLING	123
STIQAM	31, 135
STIQUAM	289
STRAFOR	72, 88, 113, 114, 196, 202, 222, 223
STRATTEC	173
STREBOR	123, 203, 227
STREMLER	25, 31, 41, 113, 143
STS	30, 46, 47, 51, 123, 124, 127, 227
STUBLINA	124
STUMPF	124
STUMPF METALL	106
STUV	33, 47, 51, 102, 103, 113, 124, 125
STV	107
SUBARU	227

ÍNDICE DE MARCAS

BRAND INDEX

MARCA - MARKA - MAIN MARQUE - MARKE	PÁG. - ORRIA - PAGE - PAGE - SEITE
SUF	63
SUKI	62
SUL	41
SUREX	125
SURFINOR	61
SUYOKA	7
SUZUKI	227, 228, 229
SWAN	156, 157
SWEDA	111
T	
TAITO	125
TALLINN	125
TANLOCKS	89
TAP-AGIS	229
TARONI	126
TAS	21
TATA	229
TAYLOR	126, 127
TAYMOR	127
TECHNAL	127
TECNO	73, 138, 196
TECNOLAR	124
TECNOR	61
TECON	126
TECSESA	124, 126, 325
TECUMSEH	229
TEICOCIL	59, 126, 127, 132
TEKA	15, 126
TELFORD	93, 203
TEM	74, 126
TERCA	8
TESA	3, 74, 78, 126, 127, 147, 247, 290
TESIO	4, 325
TESTA	31
TH	128
THOMAS LAIDLAW	127
THONE	41
THT	72
TIBBE	187, 229
TICINO	128
TIEFENTHAL	53, 69, 80
TIFON	128
TIGRIS	128
TITAN	86, 128, 129, 229
TITANO	326
TITUS	152
T-KEY	125
TM	47
TOK	22, 237
TOK WINKHAUS	130, 131, 237
TOKAJ RIKA	177, 230, 231, 232, 233
TOMSK	132
TOOL BOX	229, 230
TOP	105, 132
TOPLOCK	127
TOVER	20, 63, 132, 326
TOY	2
TOYOTA	230, 231, 232, 233

MARCA - MARKA - MAIN MARQUE - MARKE	PÁG. - ORRIA - PAGE - PAGE - SEITE
TRAMA	223, 224
TRAVEX	132
TREE	39
TRELOCK	130, 131, 132, 144, 233, 237
TRI CIRCLE	52, 133
TRI STAR	134
TRIMARK	134
TRINITY	102
TRIO	134
TRIO-VING	134, 246, 290, 291, 292
TRITON	33, 80
TRIUMPH MOTORCYCLE	233
TROMER	98, 101, 132
TRUMPH	128
TRUPER	134, 135
TRW-SIPEA	234
TRYBA	56
TSAG	135
TUFF	253
TULA	135
TÜRSCHLOSS	21
TUSHINO	135, 326
TUTIS	53
TZAFRER	37, 65, 135
U	
UBE	185, 186, 188, 194, 195
UCEM	44, 135, 136, 146, 292
ULIANOVSK	136
ULTRA	93, 94, 204
UMF	136
UNIFOR	110
UNION	92, 93, 137, 138, 203, 204, 227, 234, 292
UNIPART	
UNIVERSAL	138, 139, 140, 141, 142, 253
URBIS	142
URKO	142, 349
US	82
UTZ	93, 119, 204
V	
VACHETTE	78, 79, 86, 88, 129, 130, 143, 144, 145, 146, 224, 225, 235, 236, 340
VAGO	111
VALEO	217, 219, 220, 232, 236
VARIOS	146
VAUGHN	72, 119
VBH	146
VDO	189
VEGA	13, 113, 146
VELO	156, 157
VENDI	146, 147
VENLOCK	127
VERA	117
VERSCO	41
VG F VILLATORE	147
VIDMAR	117, 118
VIKI	47
VILLFER	333
VINCO	143, 144

MARCA- MARKA- MAIN MARQUE - MARKE	PÁG. - ORRIA - PAGE - PAGE - SEITE
VING	147
VIP	31
VIRO	2, 147, 148, 240
VISO	156, 157
VISONIC	11, 161
VOKO	33, 80
VOLGA	236
VOLGOGRAD	148
VOLKOVYSK	148
W	
WALE	152
WALLY	148
WALRUS	148, 149
WANJIN	149
WASO	33, 162, 174, 218, 220, 236, 237
WEBER	149
WEBSTER	149
WECO	22, 33, 149, 152, 178
WEDO	54
WEISER	59, 149
WELKA	149, 326
WEPA	80
WESCO	162
WESLOCK	149
WEST LOCK	150, 237
WHITCO	150
WIGRO	150
WILKA	150, 151
WILLENHALL	67
WILMOT BREEDEN	204, 205
WINFIELD	156, 157
WINKHAUS	151
WINLOCK	151
WINNER	65, 70
WIREROPE	151
WITTE	185, 186, 187, 188, 194, 195, 237
WMS	152, 292
WOC	63, 152
WSM	28
WT	152

MARCA- MARKA- MAIN MARQUE - MARKE	PÁG. - ORRIA - PAGE - PAGE - SEITE
Y	
YAC	113, 222
YALE	20, 22, 23, 40, 63, 119, 152, 153, 154, 155, 156, 162, 165, 166, 237, 238, 253, 254, 292, 327, 349
YALTRES	25, 63
YAMAHA	238, 239, 240
YANEDIS	54
YARD	157
YARDENI	156, 157
YEMAR	127, 136
YETI	92, 98, 156, 157
YMOS	174, 179, 185, 188, 190, 191, 192, 193, 215, 216, 223
YUGO	240
YUN HUAN	157
YVEL	112, 170
YWS	157, 240
Z	
ZADI	157, 158, 233, 240, 241
ZAIN	17, 18
ZANI	73
ZAZ	236
ZECE	41
ZEISS IKON	254, 255
ZENI	32, 158
ZENICA	31
ZENITH	31, 32, 119
ZIL	199, 241
ZUNDAPP	178

LLAVES PLANAS PARA CERRADURAS DE CILINDRO

SARRAILA ZILINDRIKOTARAKO GILTZA ZAPALAK

CYLINDER KEYS

CLES POUR CYLINDRES

ZYLINDERSCHIÜSSEL



Tél. 04 73 84 84 94

info@palserviceminute.com

THE KEY TO EXCELLENCE

GLOBALLY UNLOCKING MILLIONS OF DOORS DAILY

45

303

333

PARA-FOR:

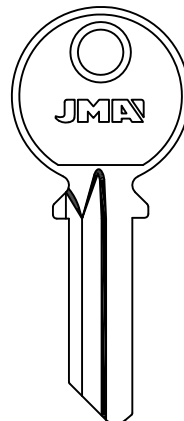
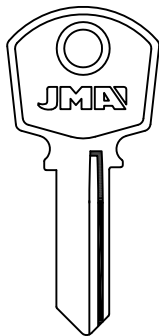
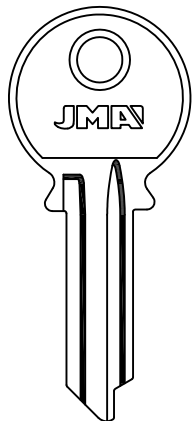
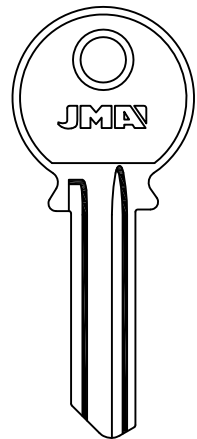

45 (RUS)

303 (RC)

333 (IL)

3M (PRC)

A.M. BARAS (GB)

ABA (SF)

ABC (E)



45-1

45-1D

45-2

45-2D

303-1

303-1D

333-1D

333

3M

A.M. BARAS

ABA

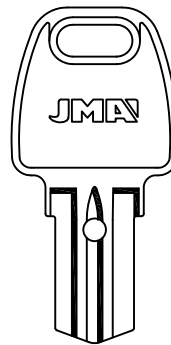
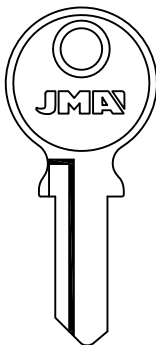
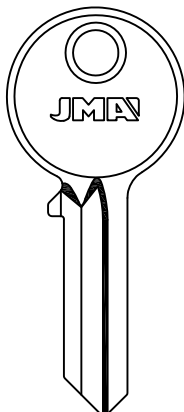
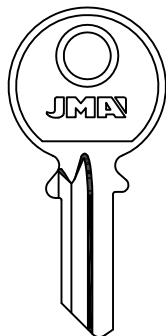

LAT.



333-2D

3M-1D

AMB-1

AMB-1D

ABA-1

ABC

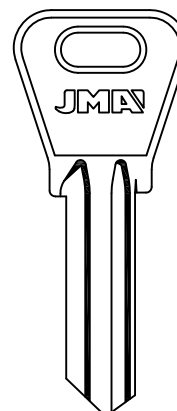
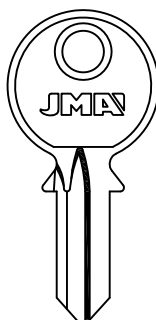
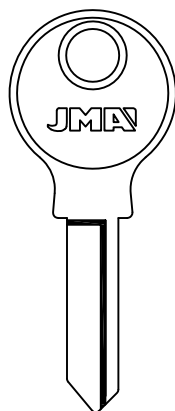
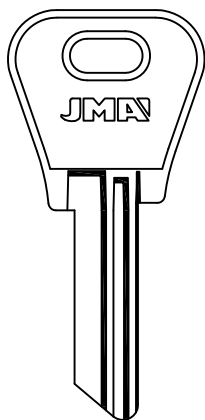

ABC-1

BAGEM



ABC-2



ABC-3D



ABC-5I



ABC-5D

BAGEM

JMA[®]







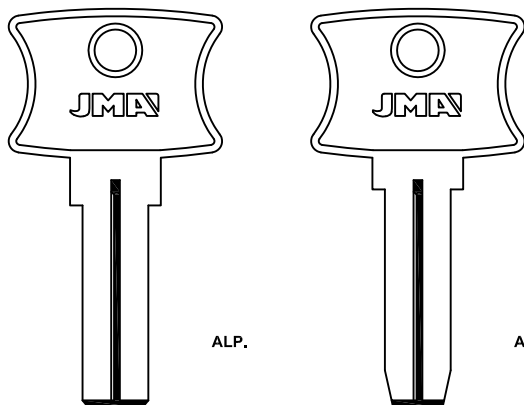

Copyright by Alejandro Altuna S.A. 2014

ATENCIÓN: Concerniente a las marcas y denominaciones comerciales ver nota en índice.
ATTENTION: Concerning the marks and commercial denominations see note in index.
ATTENTION: Concernant les marques et dénominations commerciales voir la note dans l'index.
ACHTUNG: Beziehen auf die marke und handelsname sehen sie die notiz im index.

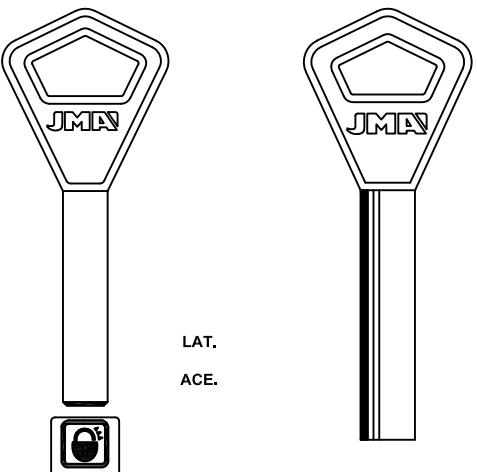
PARA-FOR:

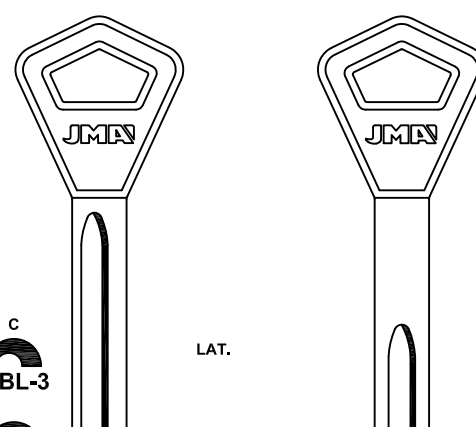
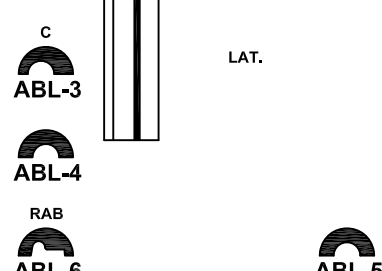
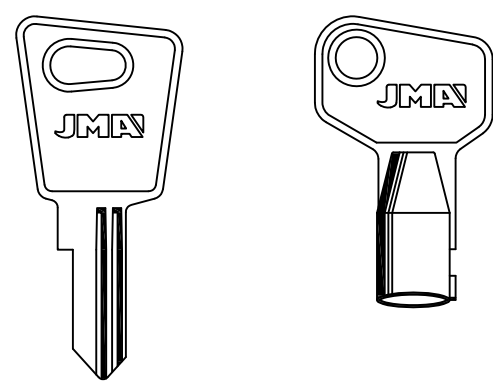
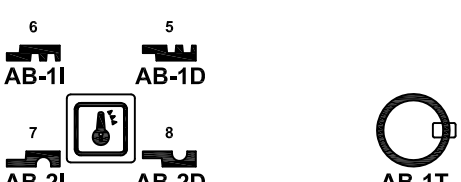
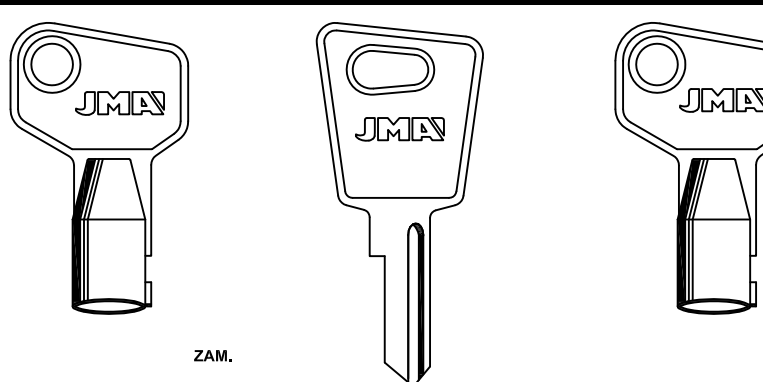
- ABC (E)
- ABLOY (SF)
- ABSA (E)

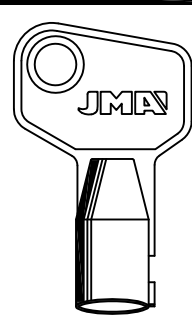
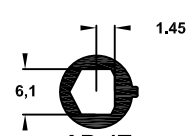
ABC	ABLOY
 <p>ALP. ALP.</p>  <p>8,7 2,30 ABC-6 ABC-7</p> <p>BAGEM BAGEM</p>	 <p>LAT. LAT. ACE.</p>  <p>0 AL 9 ABL-1 ABL-2</p> <p>KITTY-VIRO</p>
ABLOY	ABSA
 <p>LAT. LAT.</p>  <p>C ABL-3 ABL-4 RAB ABL-6 ABL-5</p>	 <p>ZAM. ZAM. ZAM.</p>  <p>6 5 AB-11 AB-1D 7 8 AB-2I AB-2D AB-1T</p> <p>M.LUNA KEYA</p>
ABSA	
 <p>ZAM. ZAM. ZAM.</p>  <p>6 AB-2T 60 AB-3I 7 AB-3T</p> <p>KEYA-TOY M.LUNA KEYA</p>	 <p>ZAM.</p>  <p>1,45 6,1 AB-4T</p> <p>KEYA</p>



ABSA

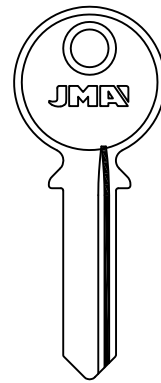
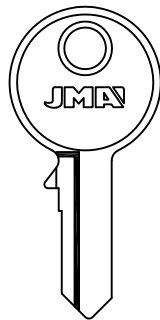
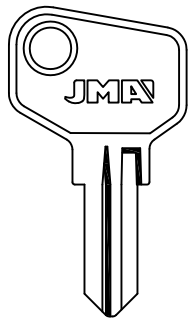
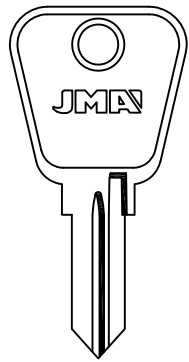

FROSER



ARFE-FROSER-KEYA



KEYA

PARA-FOR:

ABSA (E)

ABUS (D)

ABUS

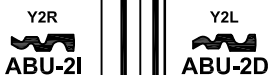
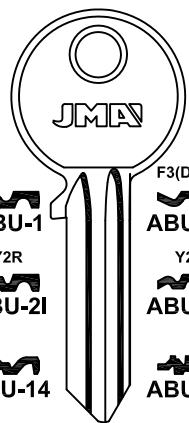

CISA-ISEO-JPM-SCHUCO

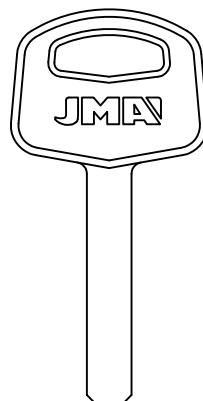

GRANIT



BULIT

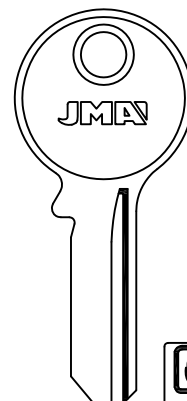

ANCHOR-JET-JMP-KALE-TESA

ABUS

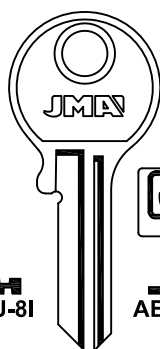
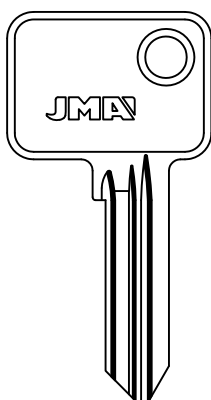

ANCHOR-FTH-IMP

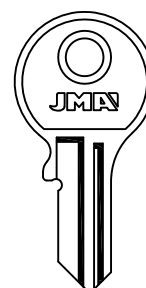
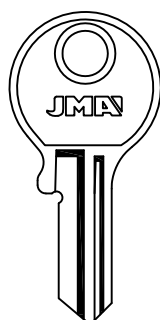

JMA[®]

Copyright by Alejandro Altuna S.A. 2014







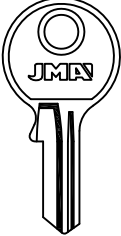
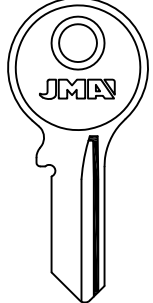
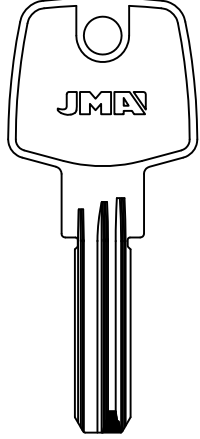

ATENCIÓN: Concerniente a las marcas y denominaciones comerciales ver nota en índice.
 ATTENTION: Concerning the marks and commercial denominations see note in index.
 ATTENTION: Concernant les marques et dénominations commerciales voir la note dans l'index.
 ACHTUNG: Beziehen auf die marke und handelsname sehen sie die notiz im index.

PARA-FOR:

ABUS (D)

ABUS

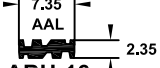
ABU-11 ABU-11D CISA



ABU-13 ABU-13D

ABU-21
ANCHOR-BURG
GUITTEL-IMP-ROYAL

7.35
AAL
2.35
ABU-16
EXTRA CLASSE
CISA-BRICARD

LAT.

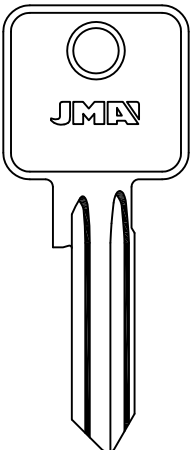
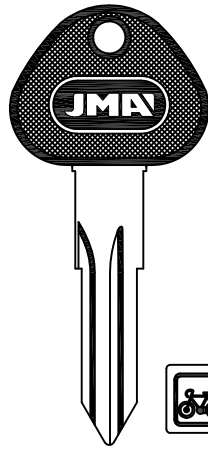
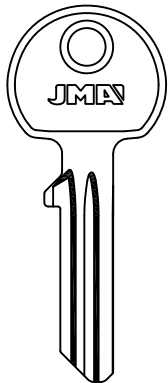
ABUS

ABU-48

ABU-58D

K1D
ABU-70

ABU-77

ABU-80

ABU-83

X4S
* ABU-85



ABU-17 ABU-17D CISA

* LAT.

Z71....1-1043
Z72....1-1043
ABU-18.P ABU-18D.P BUFFO

Z71....1-1043
Z72....1-1043
ABU-19D BUFFO

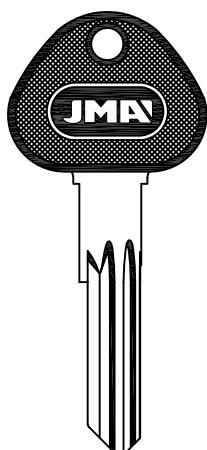
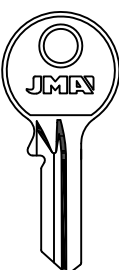
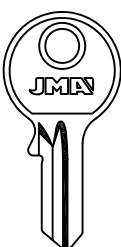
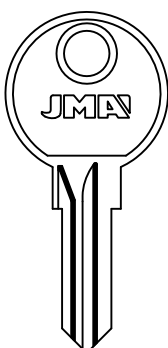
ABUS

Z71....1-1043
Z72....1-1043
ABU-19.P ABU-19D.P BUFFO

ABU-22D

ABU-23D CISA

ABU-24D



ABUS

PARA-FOR:

ABUS (D)

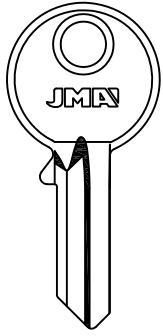

ABU-25D

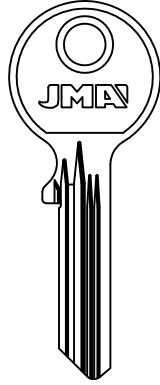

ABU-26D

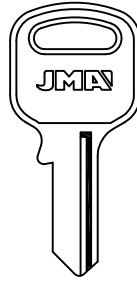

ABU-27



CISA

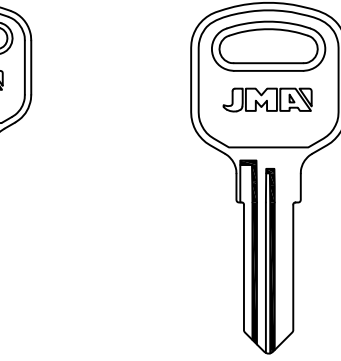

ABU-27D

ABU-28

ARMSTRONG-BUFFO

ABUS

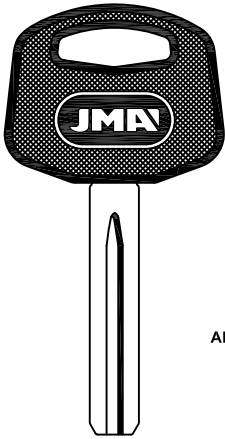

ABU-29.P

PLUS

ALP.

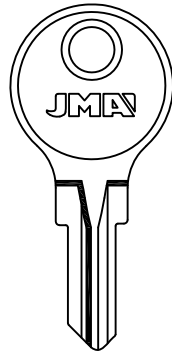

ABU-30

ABU-30D

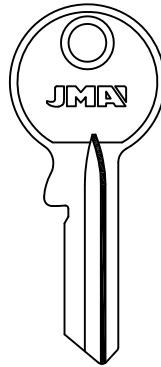

ABU-32D

ANCHOR-IMP

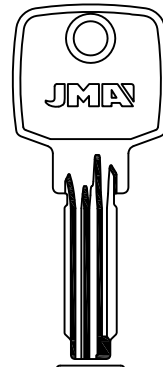

30-40

EC 75

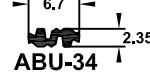

ABU-34

LAT.

ABUS

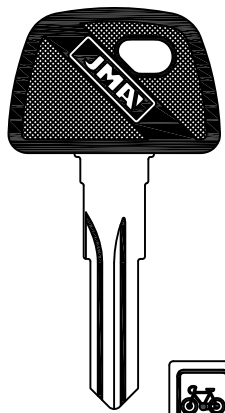

X61... 1-331
X62... V61...

ABU-35.P

BUFFO



V62...
ABU-36.P

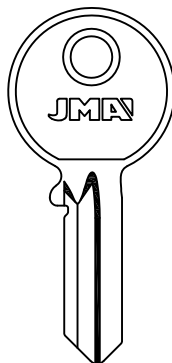

40-50-60
ABU-38D

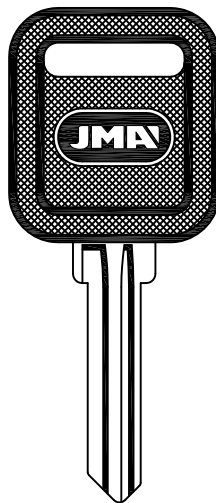

ABU-39.P

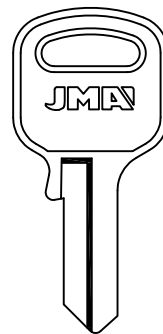

ABU-45



ABU-40

ANCHOR-BURG-GUITTEL
IMP-ROYAL



PARA-FOR:

ABUS (D)

ABUS

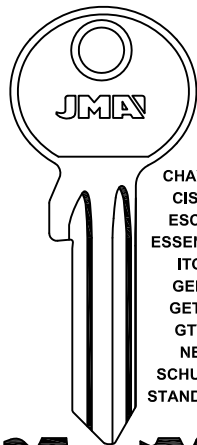

ABU-41 ABU-41D



ABU-68

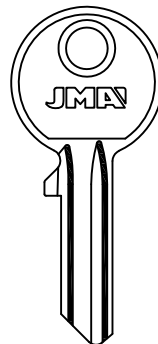

...1-342
EF...1-724
B...1-342
EE...1-724
ABU-42

E....
ER....
801-1236
ABU-42D

BUFFO-CISA

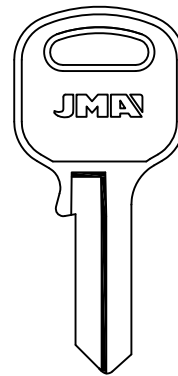

ABU-60 ABU-50

ANCHOR-JMP

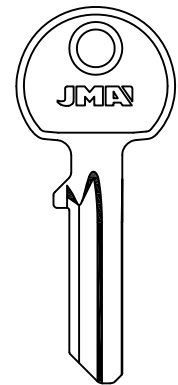

ABU-51D

ABUS

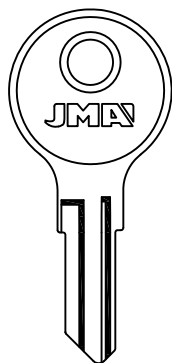

ABU-54 ABU-54D

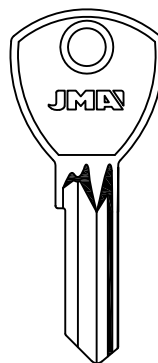

ABU-57 ABU-57D

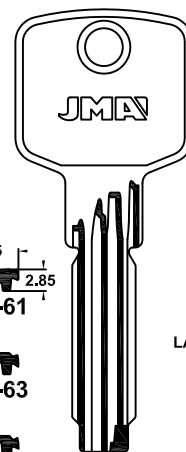

ABU-61
ABU-63
ABU-66

LAT.

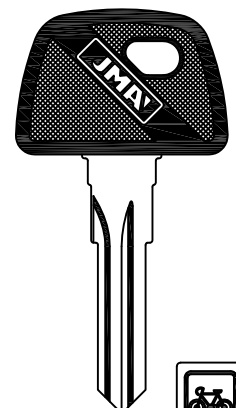

U72
ABU-64.P

W71
ABU-65.P

ABUS

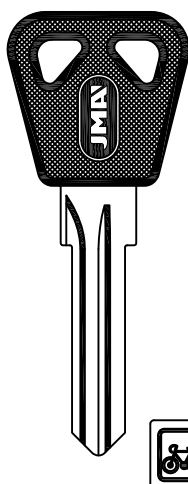

ABU-72.P

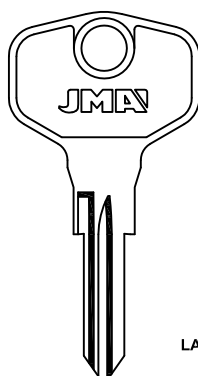

LAT.

ABU-73D

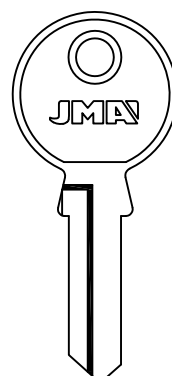

ABU-75D

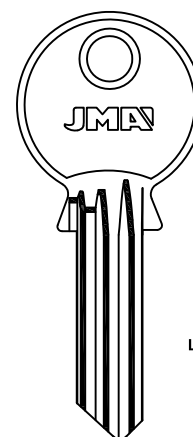

LAT.

004
ABU-78

GE GE

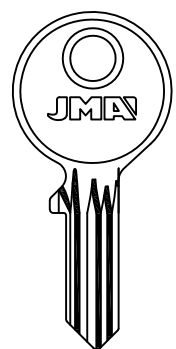

AL
ABU-79

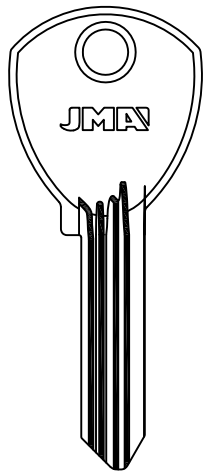
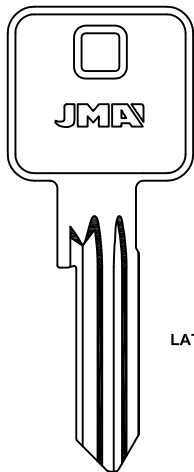

ABUS
ABU-84D
ABU-86D

LAT.

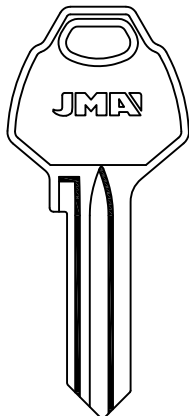
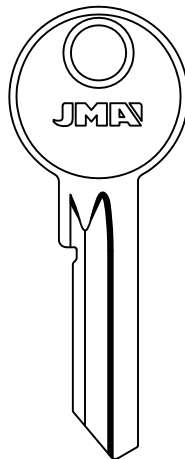
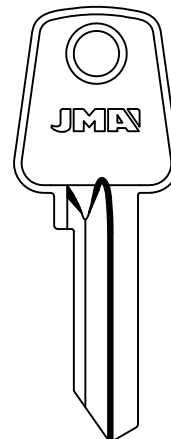
ADAMSRITE
ADS-1D**AEP**
AEP-1D
AEP-2D**PARA-FOR:**

ABUS (D)

ADAMSRITE (GB)

AEP (RUS)

AGA (E)

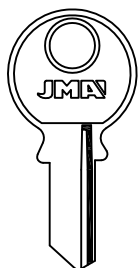
AGA

T1

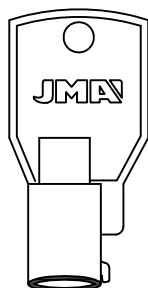
AGA-1I

AGA-1T

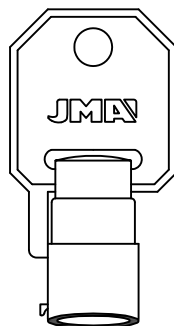

AGA-2T

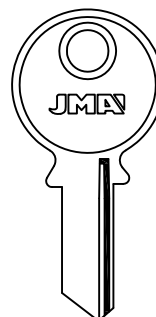

AGA-3I

LAT.

LAT.

FAC-KEMEN-KIFER-RONEO

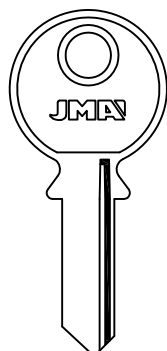
AGA

AGA-4I



AGA-4D

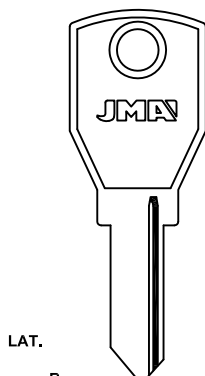

LAT.

B

901-926

AGA-5I

D

901-926

AGA-6I

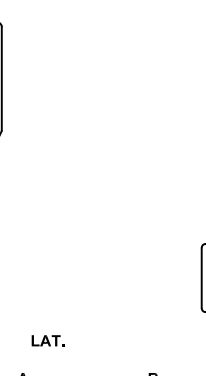

LAT.

A

901-926

AGA-5D

C

901-926

AGA-6D



B

501-526

AGA-18I

D

501-526

AGA-19I

A

501-526

AGA-18D

C

501-526

AGA-19D

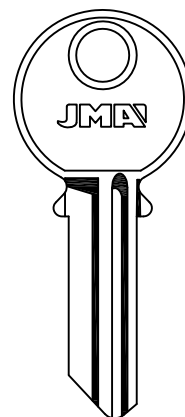

AGA-7

MECALUX-SUYOKA

JOVI

JMA[®]

Copyright by Alejandro Altuna S.A. 2014



ATENCIÓN: Concerniente a las marcas y denominaciones comerciales ver nota en índice.

ATTENTION: Concerning the marks and commercial denominations see note in index.

ATTENTION: Concernant les marques et dénominations commerciales voir la note dans l'index.

ACHTUNG: Beziehen auf die marke und handelsname sehen sie die notiz im index.

PARA-FOR:

AGA (E)

AGA

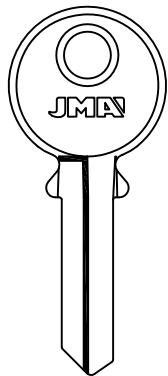

AGA-8D

GOYAL-KEMEN

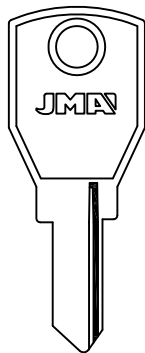

AGA-9I



AGA-23

ARREGUI-ALFA-GARI
ORENGO-RUTALCHI-SERRALLER

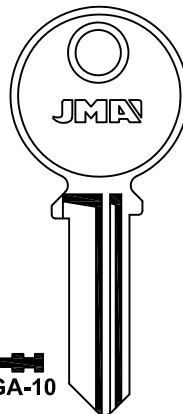

AGA-10



AGA-13I

AGA-22

GARI

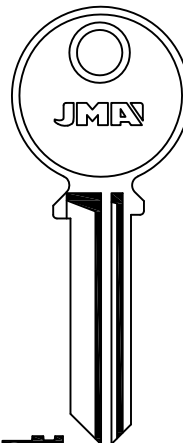

AGA-11

AGA-14D

GARI

AGA

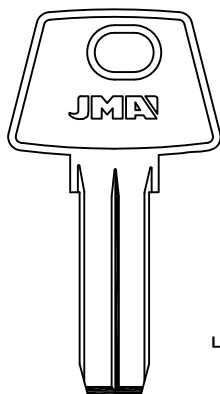

LAT.

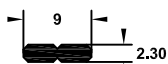

AGA-12

COLOMENCA-FB
SERRALLER-TERCA

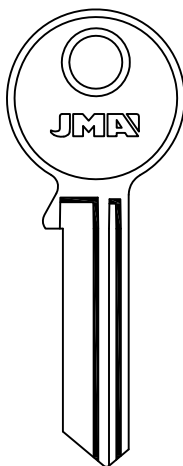

AGA-15

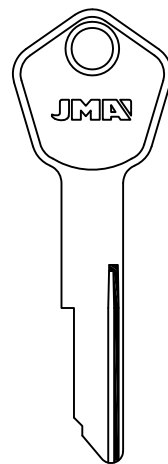

AGA-16I

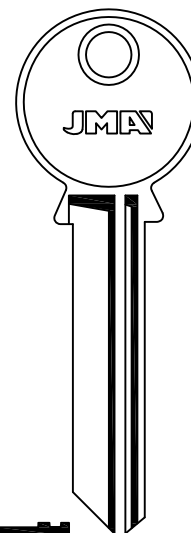

AGA-20

SERRALLER

AGA

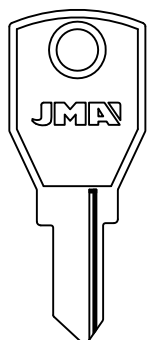

AGA-24I

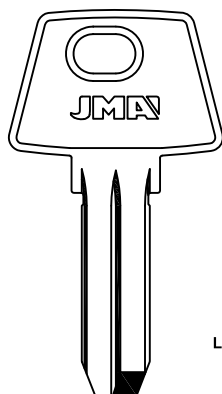

AGA-24D



AGA-25

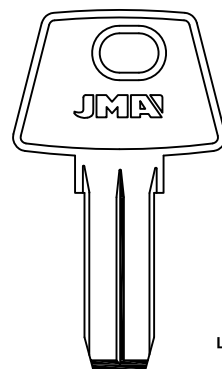

AGA-29

CASAS

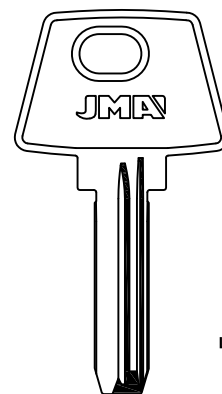

AGA-38

AGA-42

AGA-48



AGA

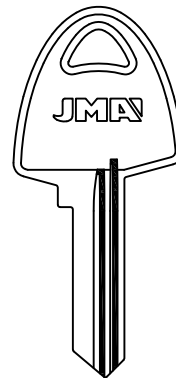
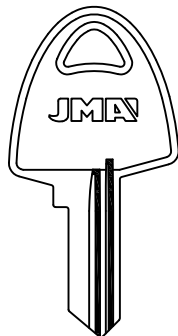
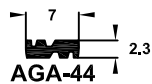
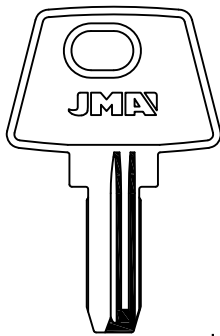
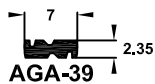
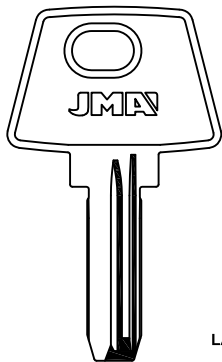

PARA-FOR:

AGA (E)

AGB (I)

AGC (P)

AGE (J)

AGB

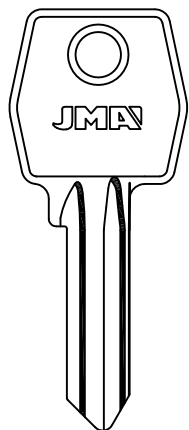

OIAUS

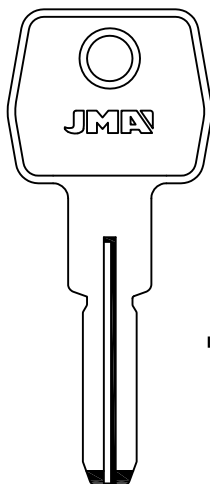

SCUDO

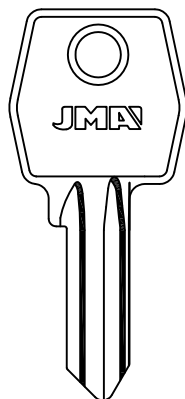

OIAUS

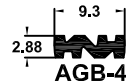
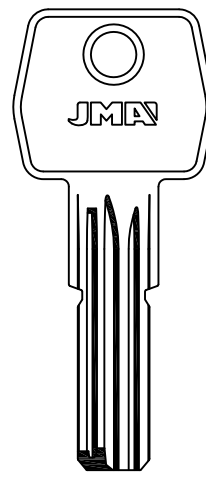

SCUDO 5000

AGB

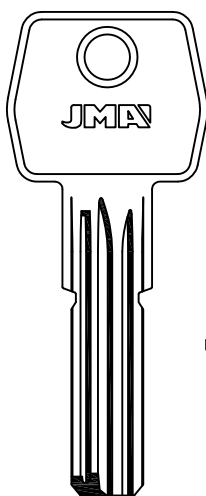

SCUDO 5000

AGC

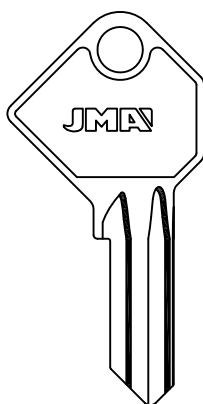
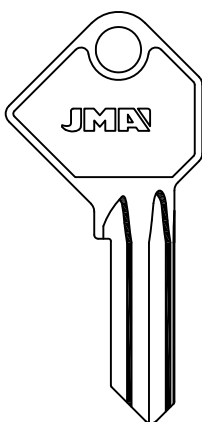

AGE

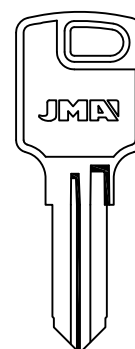

PARA-FOR:

- AGE (J)
- AGUIA (P)
- AGUT (E)
- AHRAM (ET)
- AIZPUTE (RUS)
- ALDRIDGE (GB)
- ALE (E)

AGE	AGUIA			
 AGE-2D	 701 AG-1I	 701 AG-1D	 706 AG-6I	 706 AG-6D
	 703 AG-3I	 703 AG-3D	 708 AG-8I	 708 AG-8D
	 704 AG-4I	 704 AG-4D	 709 AG-9I	 709 AG-9D
	 705 AG-5I	 705 AG-5D	 710 AG-10I	 710 AG-10D
			 AG-11	 AG-11D
AGUT	AHRAM	AIZPUTE	ALDRIDGE	
 AGU-1D	 AHR-2	 AIZ-1	 AL-1I	
	 AHR-3	 AIZ-2D		
	 9 2,5			
ALDRIDGE		ALE		
 AL-2	 AL-3	 ALE-1		
 ALE-1D	 ASEC	 ASEC		



ALFA

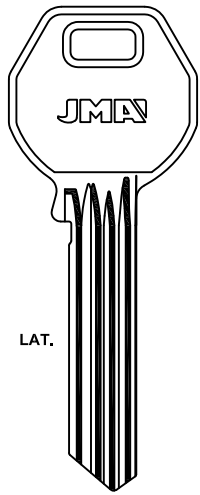

ALF-8	ALF-8D	ALF-15	ALF-22D	ALF-29	ALF-36
ALF-7		ALF-14D	ALF-21	ALF-28	ALF-35
ALF-6		ALF-13D	ALF-20	ALF-27	ALF-34
ALF-5		ALF-12D	ALF-19	ALF-26	ALF-33
ALF-4		ALF-11D	ALF-18	ALF-25	ALF-32D
ALF-3	ALF-10	ALF-10D	ALF-17	ALF-24	ALF-31
ALF-1	ALF-2	ALF-9	ALF-16	ALF-23	ALF-30

GE GE

PARA-FOR:

- ALFA (S)
- ALIANCA (BR)
- ALPHA (J)
- ALTAY (RUS)
- AMARU (P)

ALIANCA

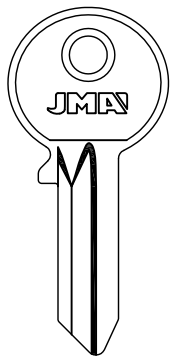

ALC-1D

ALPHA

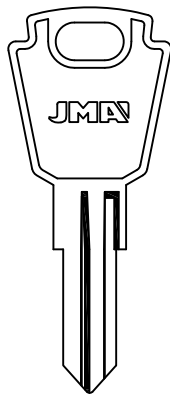

S...301-600

ALP-1I ALP-1D

FEB

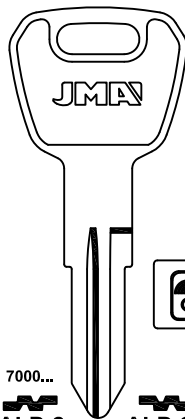

7000...

ALP-2 ALP-2D
JD-LINCE-MONACOR
SANY-VISONIC

S...301-600

ALP-6 ALP-6D

FEB

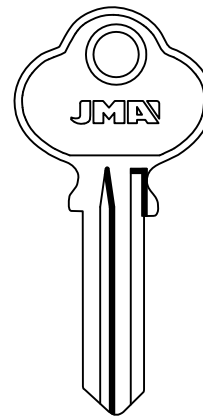

ALP-3

ALPHA

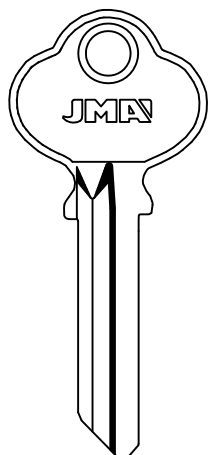

ALP-4D

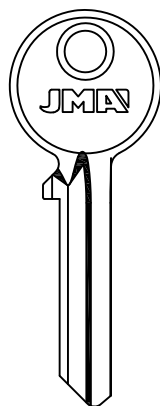

ALP-5D

ALTAY

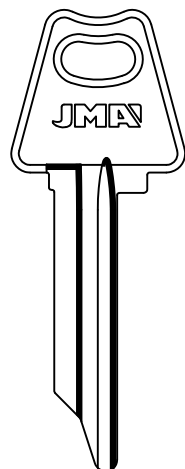

ATA-1 ATA-1D

AMARU

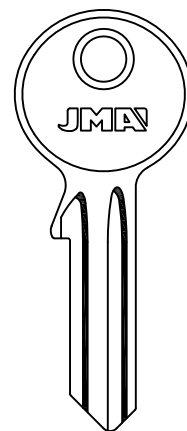

AMA-1 AMA-1D

AL









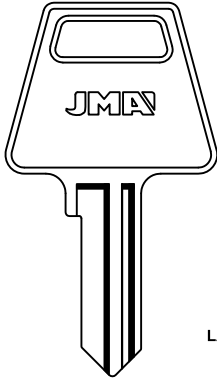
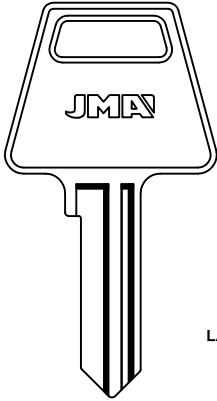
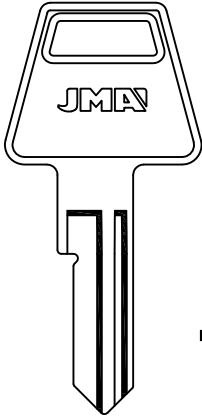
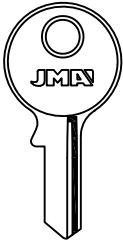

PARA-FOR:



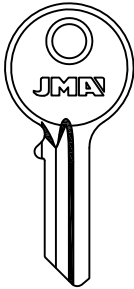
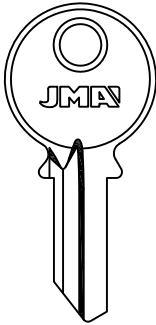
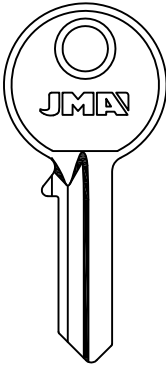
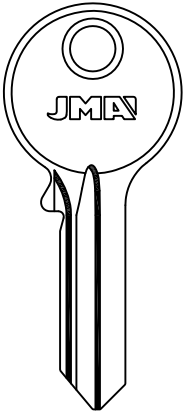

AMERICAN LOCK
(USA)

AMIG (E)

ANCHOR (S)

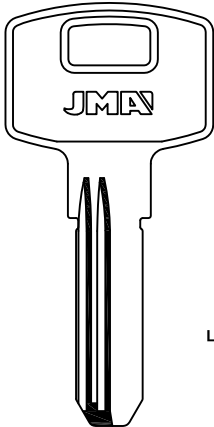
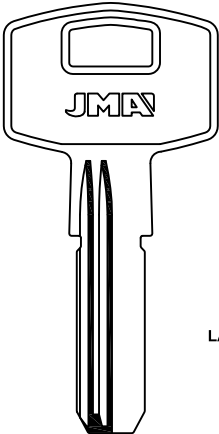
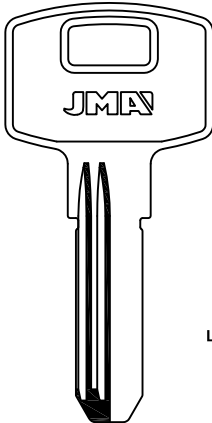
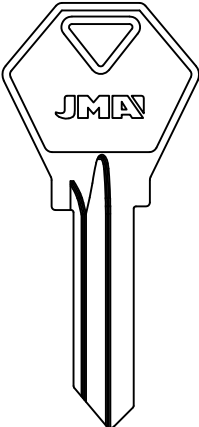
AMERICAN LOCK			AMIG
			
LAT.	LAT.	LAT.	
 AME-1	 AME-2	 AME-4	1-15 / 1-20  AMG-1

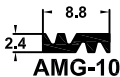
AMIG			
			
1-25  AMG-2D	1-30  AMG-3D	1-40  AMG-4D	1-50  AMG-5D

AMIG			ANCHOR
			
LAT.	LAT.	LAT.	
 AMG-8D 5000	 AMG-9D 2500	 AMG-10D 4900	 ANC-1D ANKERSLOT



ANCHOR

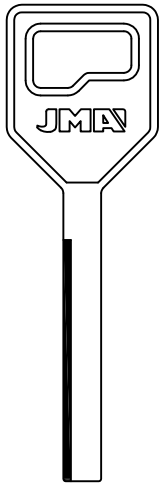

ALP.



ANC-2

ANKER

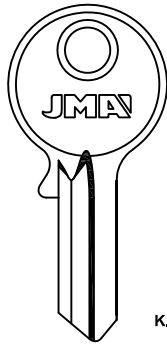

K...111-888
....
K...
1011-7077
E...
F...
B...
1-2-3-4-5-6-7



ANK-1

ANCHOR-LITTO-ODA

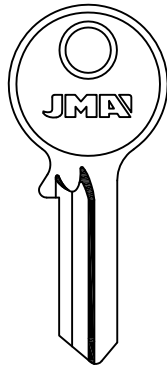

ANK-2

ODA

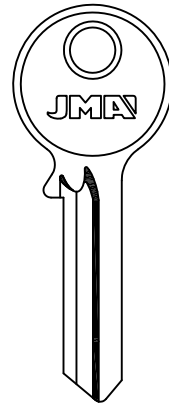

ANK-3

ODA

PARA-FOR:

ANCHOR (S)

ANKER (NL)

ANTAR (F)

APEX (RUS)

ANKER

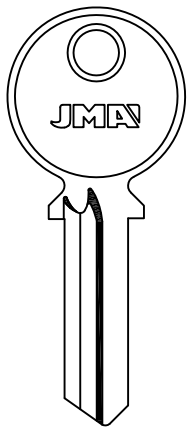

ANK-4

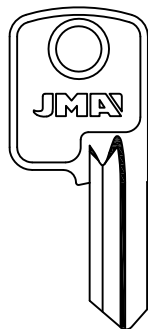

K...111-888
....
K...
1011-7077
E...
F...
B...
1-2-3-4-5-6-7



ANK-6

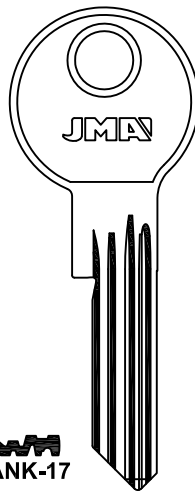

ANK-17



ANK-65

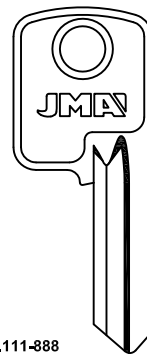

K...111-888
....
K...
1011-7077
E...
F...
B...
1-2-3-4-5-6-7



ANK-47D

ANTAR

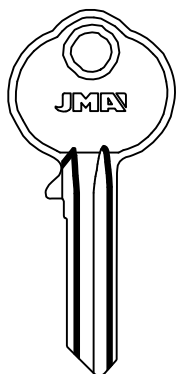

ANA-1



ANA-1D

VEGA

APEX

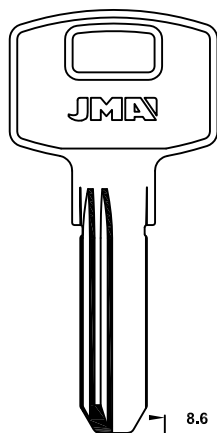

LAT.



AP-1D



AP-3D

AMIG-BYP-C.V.C.

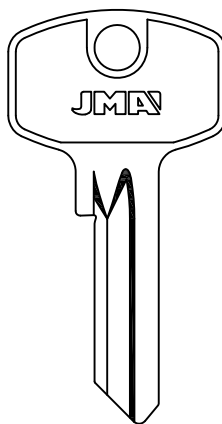

AP-2D

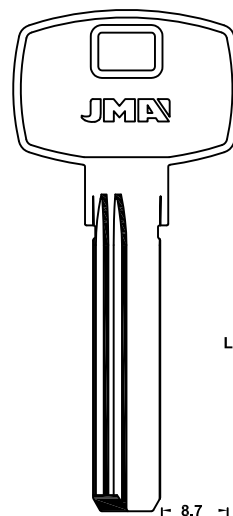

LAT.

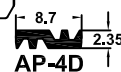











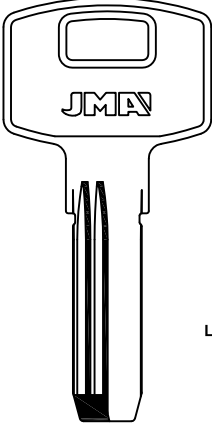
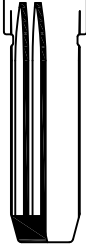
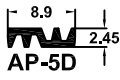
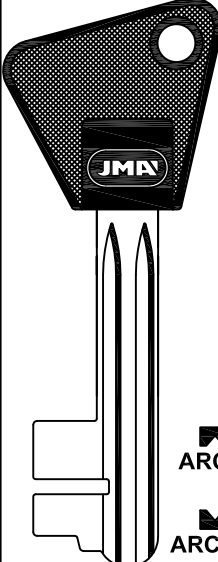
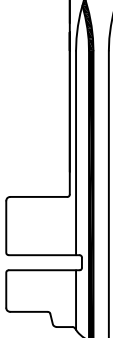

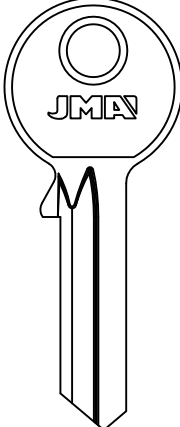
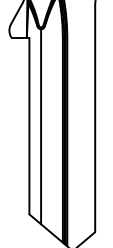

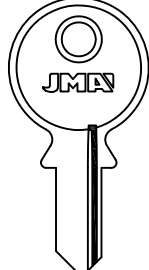
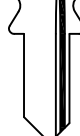
AP-4D

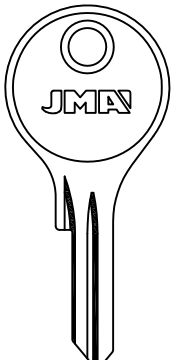
FTH

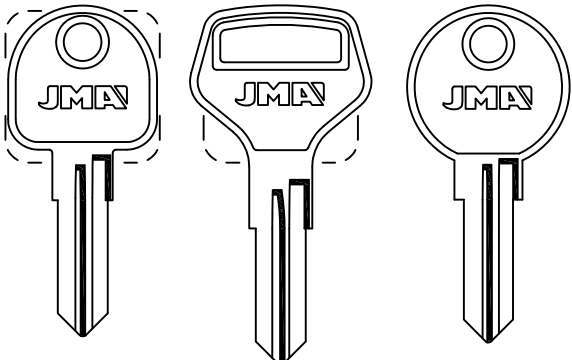
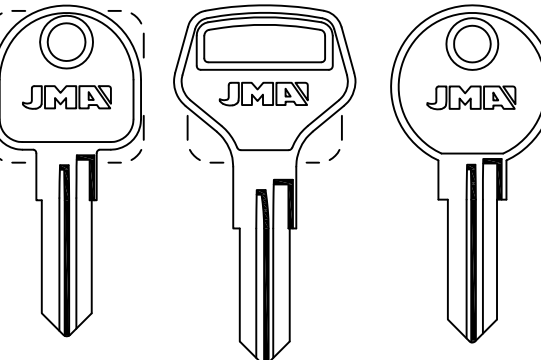

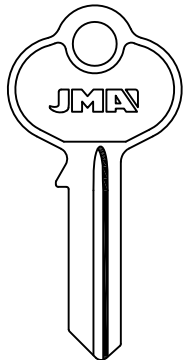
PARA-FOR:

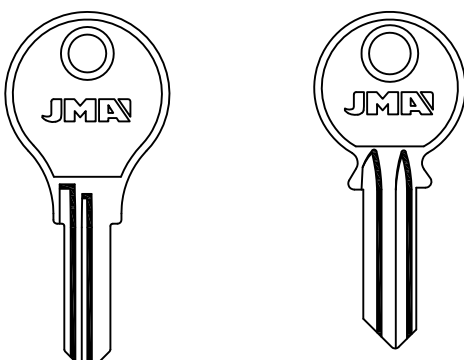
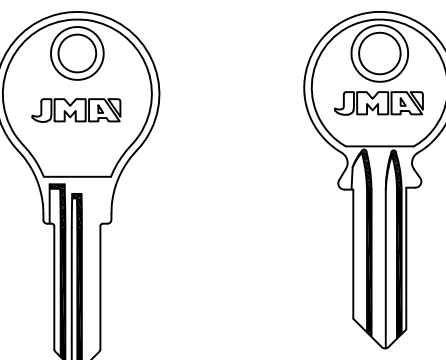
- APEX (RUS)
- ARCU (E)
- AREL (GB)
- ARFE (E)
- ARMSTRONG (USA)
- AROUCA (BR)
- ARREGUI (E)
- ARROW (USA)

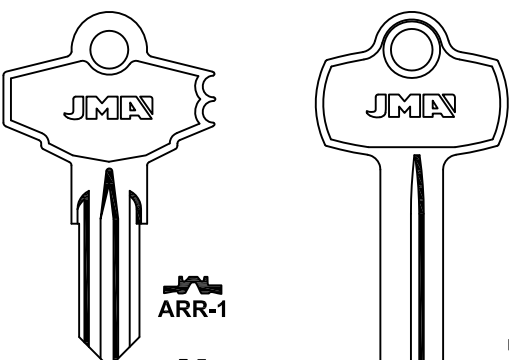
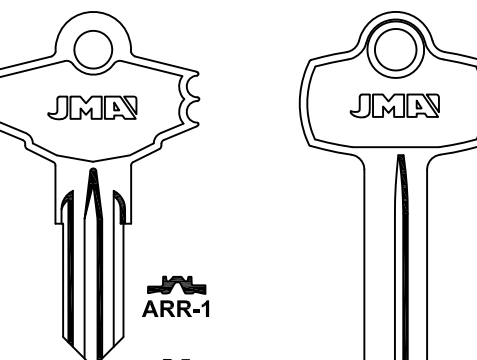
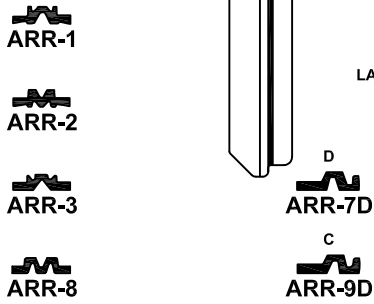
APEX	ARCU	AREL	ARFE	
   LAT.	   ALP.	   ARE-1D	   ARFE-1I ARFE-1D	
ARFE	ARMSTRONG			AROUCA
   ARFE-3D	   ARN-1 ARN-2 ARN-2D ARN-3 ARN-3D ABUS			   ARO-1D
ARREGUI		ARROW		
   AR-1D AR-4IP AR-4DP INDAUX		   ARR-1 ARR-2 ARR-3 ARR-8 ARR-7D ARR-9D DOMINION LOCK-FORT-LG LAT.		



ARSENEVSK

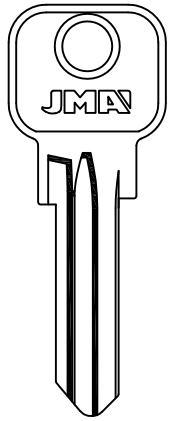

ASHICO

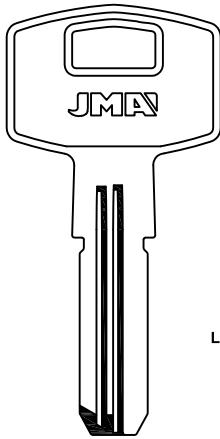

LAT.

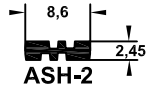

ASIA

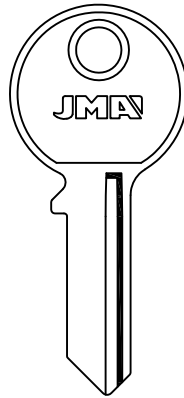

CINA

ASPA

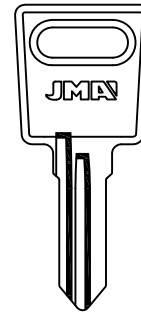

PARA-FOR:

ARSENEVSK (RUS)

ASHICO (TJ)

ASIA (RC)

ASPA (NL)

ASSA (S)

ASSA

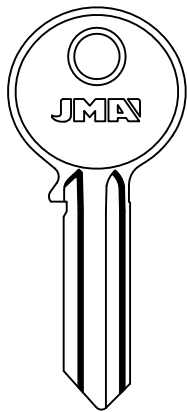

ABC
0 AL 9

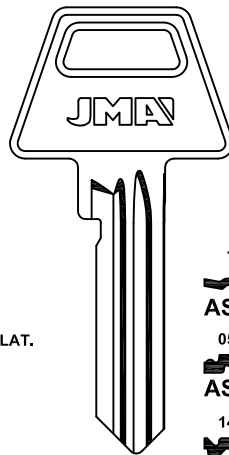

* LAT.



ASSA

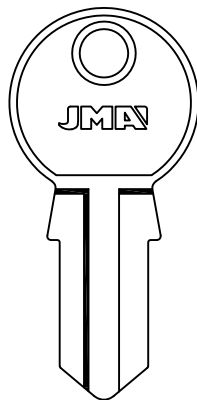
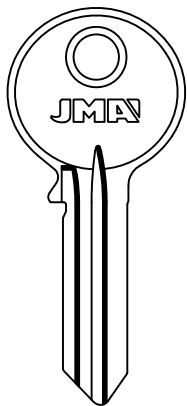

LAT.

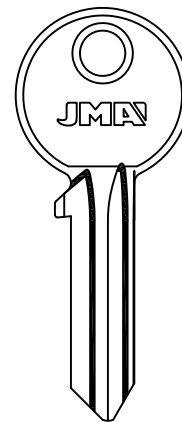

TEKA



PARA-FOR:

ASSA (S)

ASSA

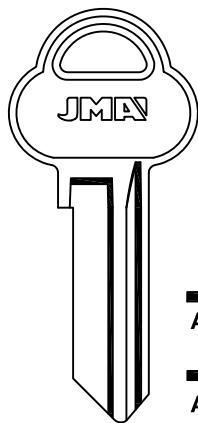

28,4 mm.

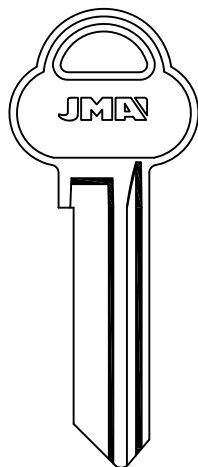

34,5 mm.



ASSA

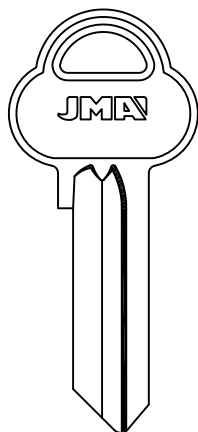

29,7 mm.



ASSA

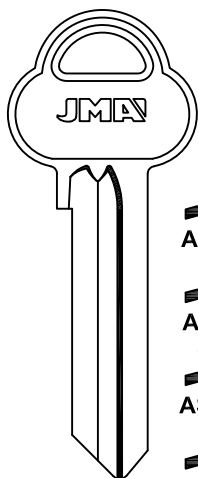

35,7 mm.



ASSA

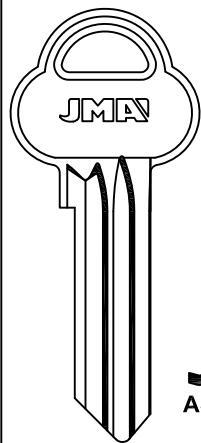

31 mm.

- 560MG
AS-MG5
- 560KE
AS-KE5
- 560ME
AS-ME5

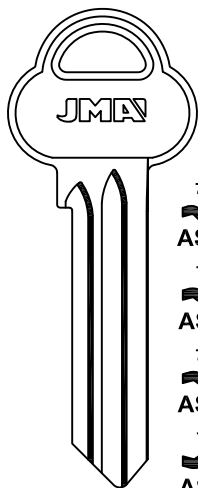

37 mm.

- | | | | | | | | |
|-----------------|-----------------|-----------------|-----------------|-----------------|-----------------|-----------------|-----------------|
| 760DD
AS-DD7 | 760HH
AS-HH7 | 760LD
AS-LD7 | 760LG
AS-LG7 | 760MA
AS-MA7 | 760ME
AS-ME7 | 760PH
AS-PH7 | 760PN
AS-PN7 |
| 760KA
AS-KA7 | 760KE
AS-KE7 | 760MD
AS-MD7 | 760MG
AS-MG7 | 760MD
AS-MD7 | 760MG
AS-MG7 | 760PR
AS-PR7 | 760PT
AS-PT7 |
| 760KD
AS-KD7 | 760KG
AS-KG7 | 760PF
AS-PF7 | 760MF
AS-MF7 | 760PF
AS-PF7 | 760PG
AS-PG7 | 760VV
AS-VV7 | 760TT
AS-TT7 |
| 760KF
AS-KF7 | 760LF
AS-LF7 | 760PA
AS-PA7 | 760MF
AS-MF7 | 760PF
AS-PF7 | 760PG
AS-PG7 | 760UU
AS-UU7 | 760WW
AS-WW7 |
| 760LA
AS-LA7 | 760LE
AS-LE7 | 760PA
AS-PA7 | 760PB
AS-PB7 | 760PA
AS-PA7 | 760PB
AS-PB7 | 760UU
AS-UU7 | 760XX
AS-XX7 |

PARA-FOR:

- ASSA (S)
- AUMON (E)
- AVANGARD (RUS)
- AZBE (E)

AUMON

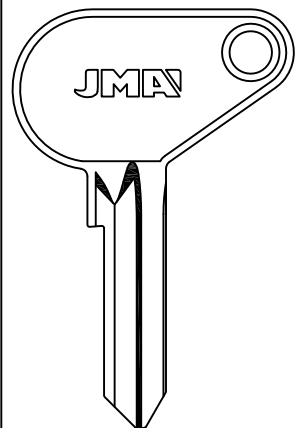

- AUM-2D

AVANGARD

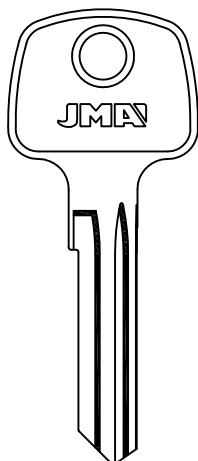

- AV-1
- AV-1D

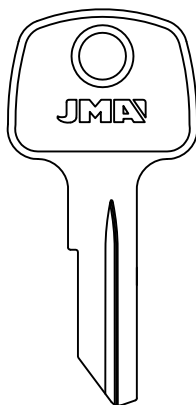

- AV-2D

AZBE

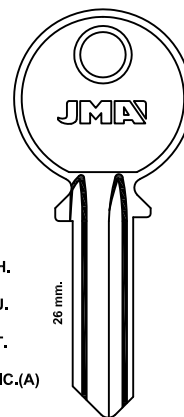

FSH.
ALU.
LAT.
* MTIC.(A)

26 mm.

- AZ-1I
- AZ-1D *

ZAIN

AZBE

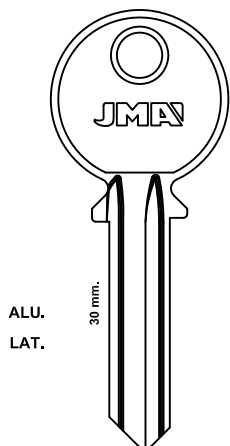

ALU.
LAT.

30 mm.

- AZ-2I
- AZ-2D

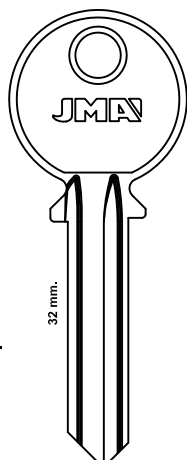

LAT.

32 mm.

- AZ-3I
- AZ-3D

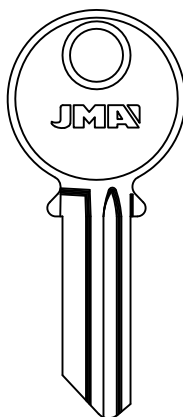

- AZ-4

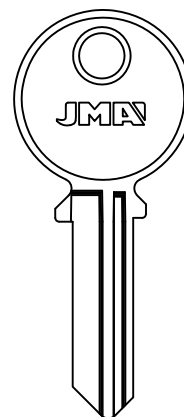

- AZ-6



PARA-FOR:

AZBE (E)

AZKOYEN (E)

B+D (GB)

AZBE

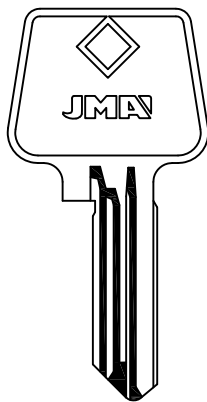

ALP.



AZ-7

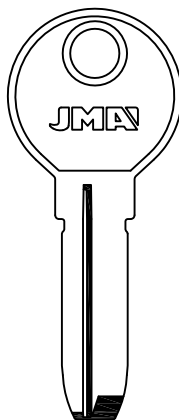

ALP.

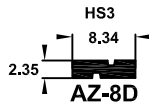

AZ-8D

IFAM

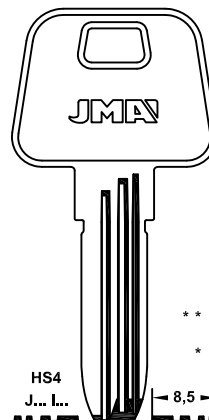

** ALP.

* LAT.

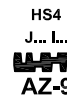

AZ-9

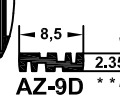

AZ-9D



AZ-12

**



AZ-29

*

CAVERS-CENTURION-ZAIN

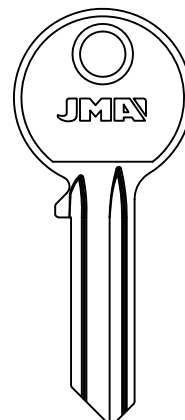

AZ-10

AZBE

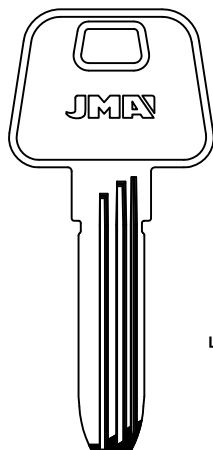

LAT.



AZ-14

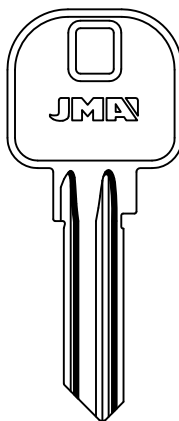

AZ-17



AZ-17D

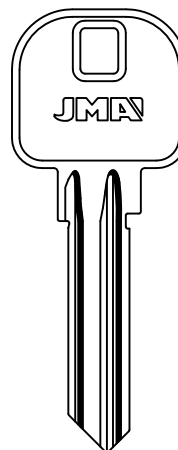

AZ-18



AZ-18D

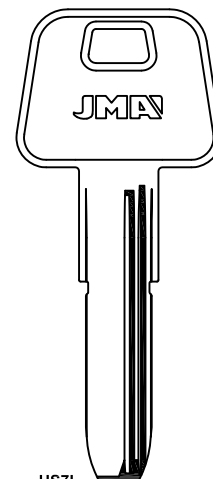

LAT.



AZ-32

AZBE

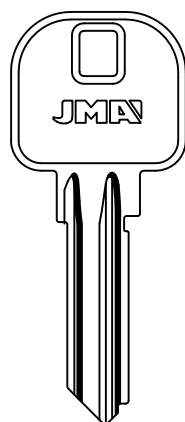

AZ-37



AZ-37D

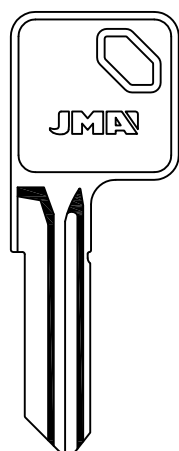

LAT.



SCO-1

SCHLAGE-SCOVILL

AZKOYEN

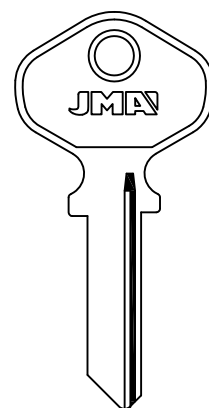

AZKO-11

AGA

B+D

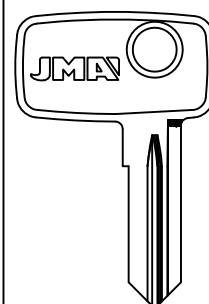

BD-1

ROLL A DOOR



BAB

PARA-FOR:

BAB (D)

BAGEM (E)

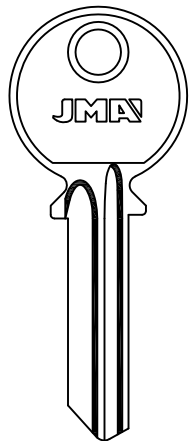

BAB-11

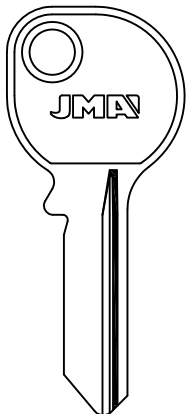

BAB-21

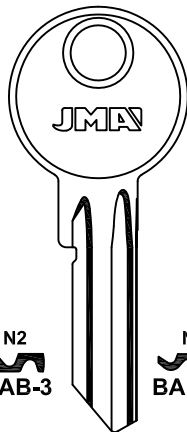

N2
BAB-3

N1
BAB-3D

BAB-12D

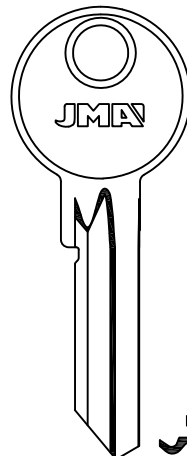

SN2
BAB-5

N1
BAB-4D

SN1
BAB-5D

BAB

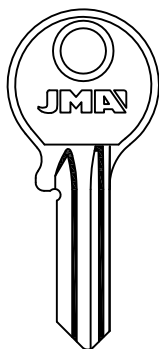

BAB-6

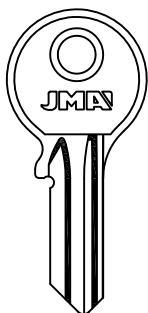

BAB-7

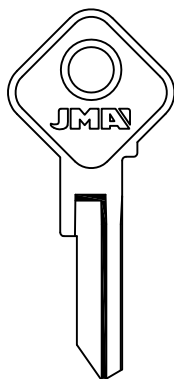

BAB-8D

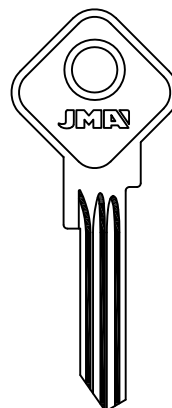

BAB-9D

BAB

BAGEM

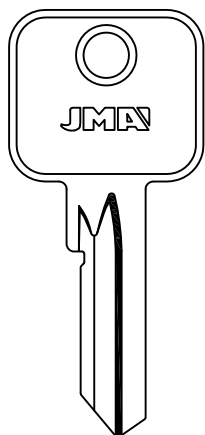

BAB-14D

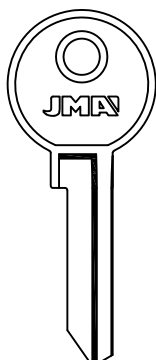

LAT.

BAB-17D

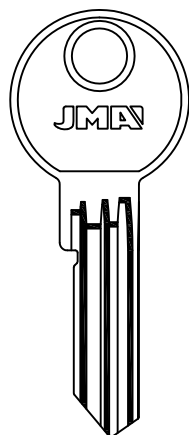

BAB-19

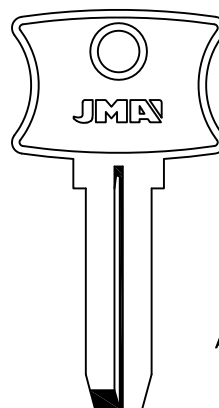







ALP.

BAG-1

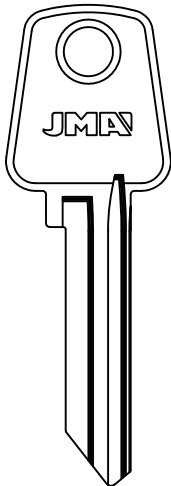
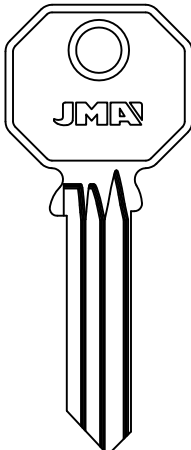
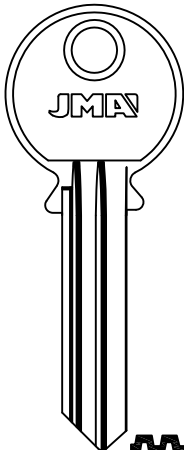
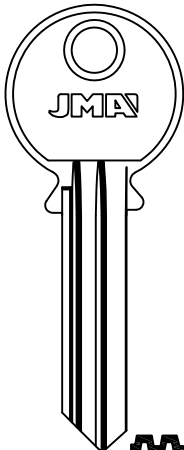

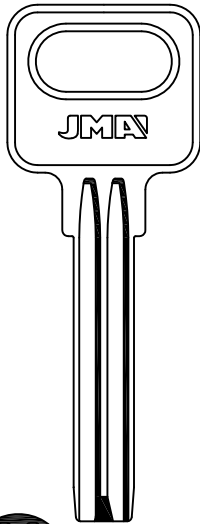
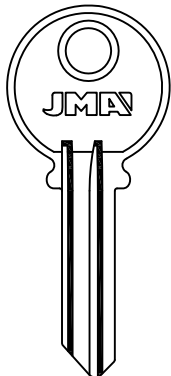
PARA-FOR:

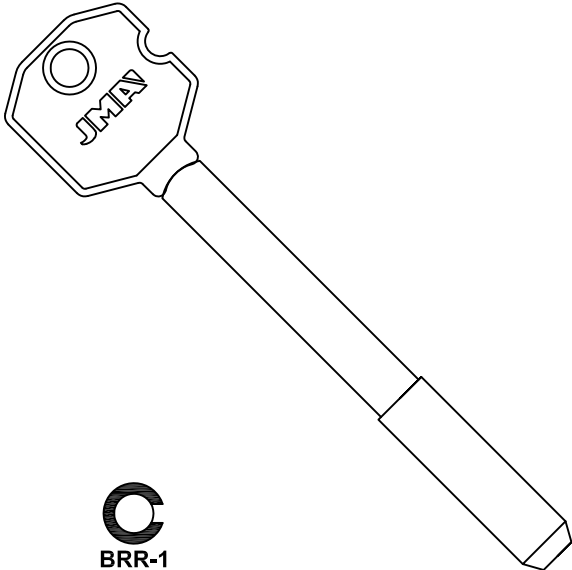
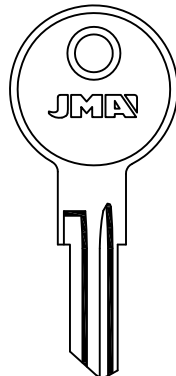
- BALTIKA (RUS)
- BANHAM (GB)
- BAODEAN (TJ)
- BARCZ (PL)
- BARIER (RUS)
- BASCO (USA)
- BASI (D)
- BASTA (IRL)

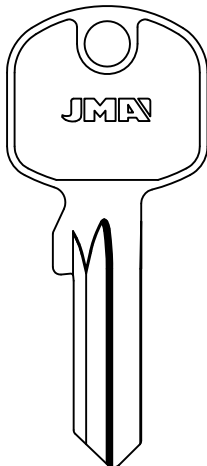
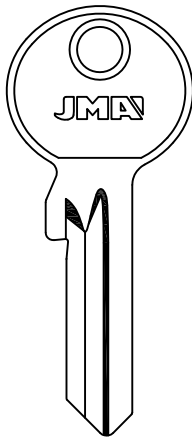
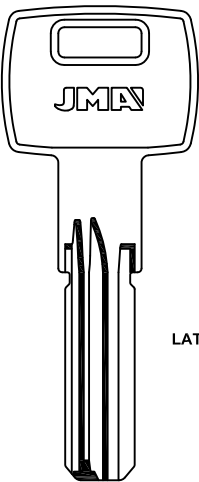
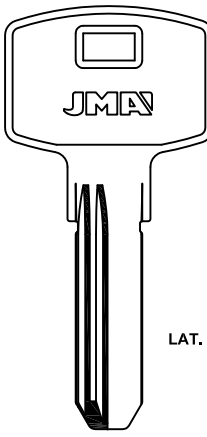
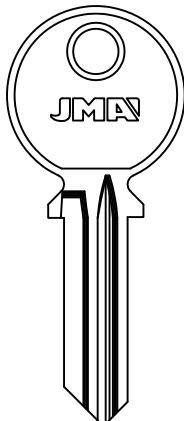
BALTIKA	BANHAM		BAODEAN
 <p>BLT-1</p>	 <p>BAN-1I</p>	 <p>BAN-1D</p>	 <p>BAN-2D</p>  <p>BAN-3D</p>  <p>BDA-1</p> <p>LAT.</p> <p>BTV</p>
BARCZ	BARIER		BASCO
 <p>BCZ-1</p>  <p>BCZ-2</p>	 <p>BRR-1</p>		  <p>BAS-4</p> <p>AMERICAN M.-B&S-CHICAGO C. ELMO-HERSEE E.-ILLINOIS-YALE</p>
BASI			BASTA
 <p>1 AL 9</p> <p>BAI-1D</p>	 <p>BAI-5D</p>	 <p>BAI-8D</p> <p>GEVY-SATURN</p>	 <p>LAT.</p> <p>TOVER</p> <p>CX</p> <p>8,6</p> <p>2,5</p> <p>BAI-9D</p>
			 <p>BAST-1I</p>



BASTA			BATU
 BAST-2D	 BAST-3D	 BAST-4D.P	 BATU-11
EURO LOCKS			

PARA-FOR:

- BASTA (IRL)
- BATU (E)
- BEST (USA)
- BETA (I)
- BEY (TR)
- BIBERING (D)

BEST		BETA	
	<p>Q BES-12D</p> <p>R BES-13D</p> <p>L BES-10D</p> <p>M BES-11D</p> <p>J BES-8D</p> <p>K BES-9D</p> <p>TB BES-17D</p> <p>G BES-6D</p> <p>H BES-7D</p> <p>F BES-16D</p> <p>DD BES-4D</p> <p>E BES-5D</p> <p>FM BES-15D</p> <p>A BES-1D</p> <p>C BES-2D</p> <p>D BES-3D</p> <p>B BES-14D</p>		
LAT.		LAT.	
FALCON		 BE-1	 BE-4I
			 BE-4D

BETA	BEY		BIBERING
 BE-5I	 BE-5D	 BEY-1D	 BEY-2D
 BE-5I	 BE-5D	 BEY-1D	 BEY-2D
PICARD		TAS-TÜRSCHLOSS	



PARA-FOR:











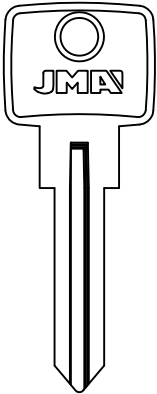
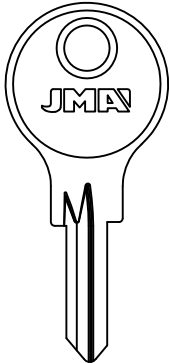
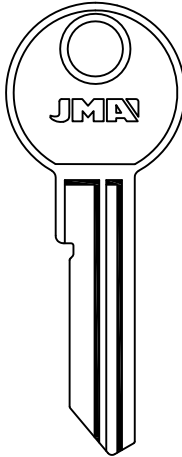
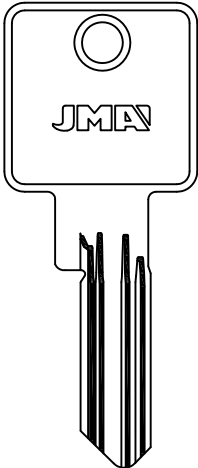





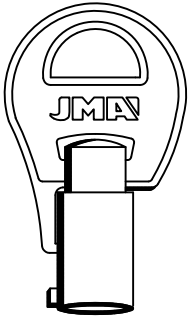
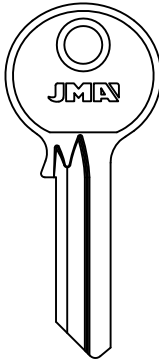
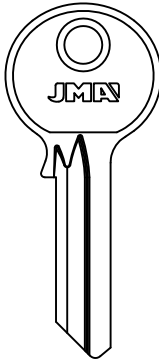
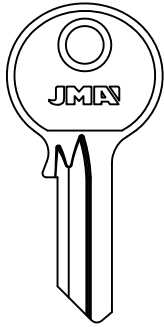





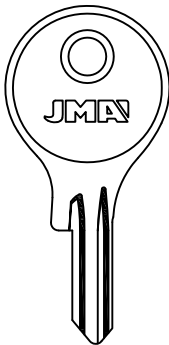
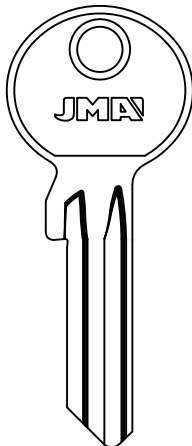





BIBERING (D)

BIELLE (I)

BIFFAR (D)

BILMA (E)

BKS (E)

BIBERING		BIELLE		BIFFAR	
					
 BI-2	 BI-3D	 BIE-1		  BIF-1	
		FASEM-OMIV-P.C.		FICHET-TOK	
BILMA			BKS		
					
	LAT.	BERRY DAMM GEBA HOHRMANN PZ YALE	ALU.		
 BIL-1T		 BK-1I	 BK-1D	 BK-2D	 R 101-105 BK-3D
			YALE		YALE-WECO
BKS					
				 BK-21/1	
				 BK-21/2	
				 BK-21/7	
				 BK-21/9	
				 BK-21/14	
 BK-4	 BK-4D			 BK-21/17	
 BK-5I	 BK-5D	 BK-6I	 BK-6D	 BK-7D	 BK-21/19
	METEOR-YALE				



BKS

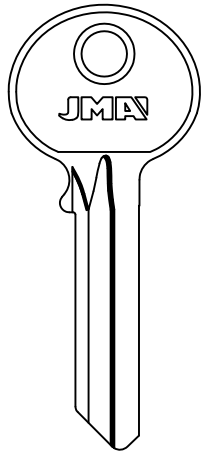

NA
BK-8D

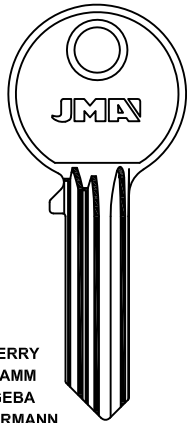

BERRY
DAMM
GEBÄ
HOHRMANN
PZ
YALE

BK-9
SERIE O

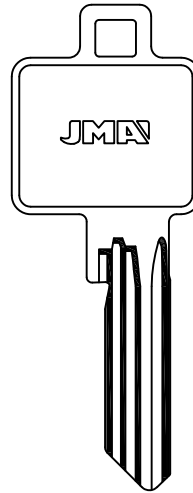

BK-14
PZ-YALE

PARA-FOR:

BKS (D)

BKS

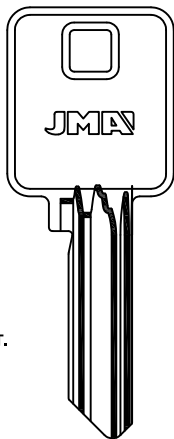

* LAT.

* BK-16/7	* BK-16/17	
* BK-16/5	* BK-16/16	BK-16/30
* BK-16/4	* BK-16/15	* BK-16/23
* BK-16/3	* BK-16/14	* BK-16/21
* BK-16/2	* BK-16/13	* BK-16/20
* BK-16/1	* BK-16/10	* BK-16/19
* BK-16/0	* BK-16/9	* BK-16/18

SERIE 2000

BKS

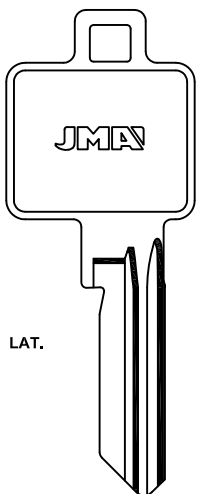

LAT.

BK-17/7PZ			BK-17/7	
BK-17/6PZ			BK-17/6	
BK-17/5PZ			BK-17/5	
BK-17/4PZ	BK-17D/4PZ		BK-17/4	
	BK-17D/3PZ		BK-17/3	
BK-17/2PZ	BK-17D/2PZ	BK-17/9PZ	BK-17/2	BK-17/9
BK-17/1PZ	BK-17D/1PZ	BK-17/8PZ	BK-17/1	BK-17/8

PZ-YALE

SERIE 0

JMA®

Copyright by Alejandro Altuna S.A. 2014



ATENCIÓN: Concerniente a las marcas y denominaciones comerciales ver nota en índice.
 ATTENTION: Concerning the marks and commercial denominations see note in index.
 ATTENTION: Concernant les marques et dénominations commerciales voir la note dans l'index.
 ACHTUNG: Beziehen auf die marke und handelsname sehen sie die notiz im index.

PARA-FOR:

- BKS (D)
- BMB (D)
- BODA (SF)

BKS

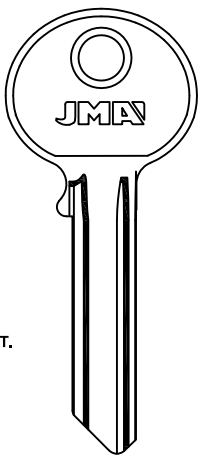

LAT.

B7 BK-18/7	B15 BK-18/15	B23 BK-18/23	B30 BK-18/30	
B6 BK-18/6	B14 BK-18/14	B22 BK-18/22	B29 BK-18/29	
B5 BK-18/5	B13 BK-18/13	B21 BK-18/21	B28 BK-18/28	B35 BK-18/35
B4 BK-18/4	B12 BK-18/12	B20 BK-18/20	B27 BK-18/27	B34 BK-18/34
B3 BK-18/3	B11 BK-18/11	B18 BK-18/18	B26 BK-18/26	B33 BK-18/33
B2 BK-18/2	B10 BK-18/10	B17 BK-18/17	B25 BK-18/25	B32 BK-18/32
B1 BK-18/1	B9 BK-18/9	B16 BK-18/16	B24 BK-18/24	B31 BK-18/31

SERIE 1000

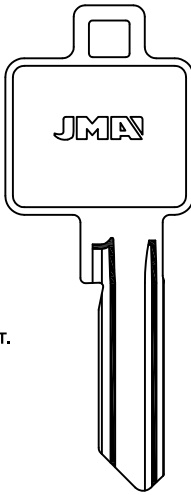

BKS



LAT.

B8 BK-19/8	B16 BK-19/16	B27 BK-19/27	
B7 BK-19/7	B15 BK-19/15	B26 BK-19/26	
B6 BK-19/6	B14 BK-19/14	B25 BK-19/25	
B5 BK-19/5	B13 BK-19/13	B23 BK-19/23	
B4 BK-19/4	B12 BK-19/12	B21 BK-19/21	
B2 BK-19/2	B11 BK-19/11	B20 BK-19/20	B32 BK-19/32
B1 BK-19/1	B10 BK-19/10	B19 BK-19/19	B31 BK-19/31

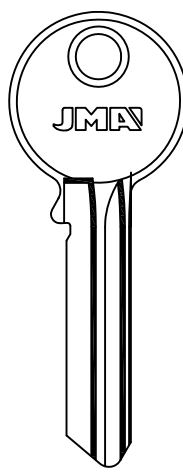
SERIE 1000

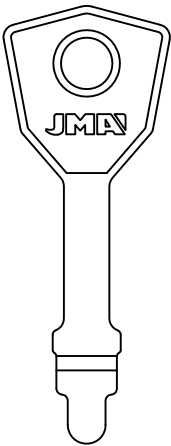
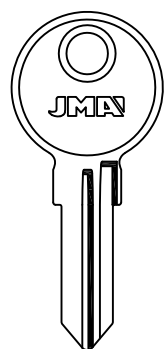
BKS	BMB	BODA
 <p style="text-align: center;">BK-20</p>	 <p>LAT.</p> <p style="text-align: center;">A BMB-1</p> <p style="text-align: center;">M BMB-3D</p>	 <p style="text-align: center;">BOD-1</p>
 <p style="text-align: center;">A...401-600 BMB-2</p>		



BOMORO

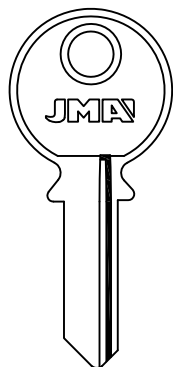
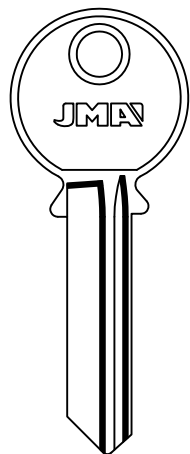

LAPORTE-PRESTA

BÖRKEY

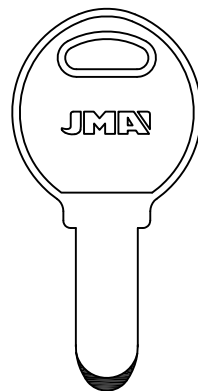
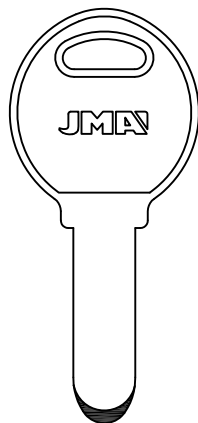

LAT.

LAT.

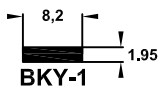

PHILLIPS-YALTRES

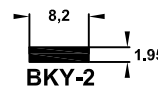

PHILLIPS-YALTRES

BOULTON & P.

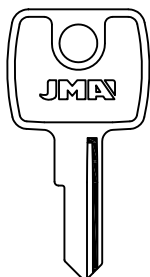

RST

BRABANTIA

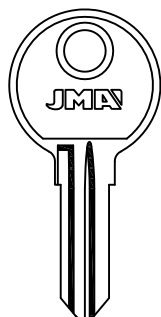

BRA-2

BRAS

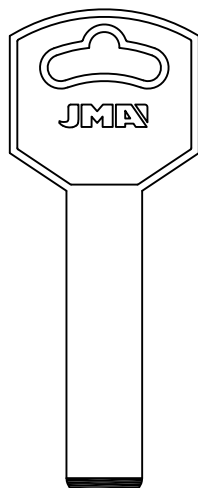

ALP.



BRAS-1

BRASIL

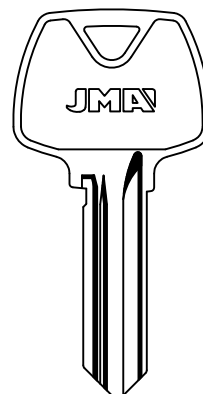

BRS-1

BRICARD

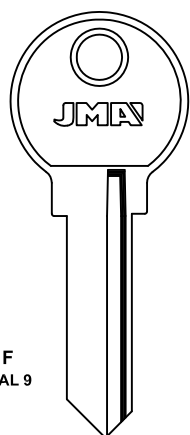

F
0 AL 9

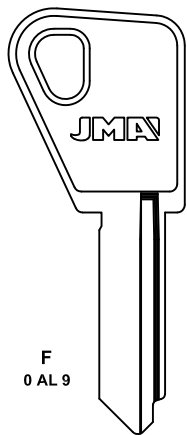

F
0 AL 9

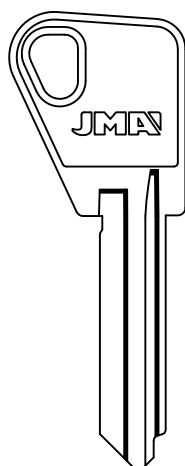

F
0 AL 9



STREMLER

PARA-FOR:

BOMORO (D)

BÖRKEY (D)

BOULTON & PAUL
(GB)

BRABANTIA (E)

BRAS (E)

BRASIL (BR)

BRICARD (F)

JMA[®]

Copyright by Alejandro Altuna S.A. 2014



ATENCIÓN: Concerniente a las marcas y denominaciones comerciales ver nota en índice.

ATTENTION: Concerning the marks and commercial denominations see note in index.

ATTENTION: Concernant les marques et dénominations commerciales voir la note dans l'index.

ACHTUNG: Beziehen auf die marke und handelsname sehen sie die notiz im index.

PARA-FOR:

BRICARD (F)

BRUMME (D)

BSS (SCG)

BRICARD

BL
BRI-10

BRI-12

LAT.

JMA

LAT.

7.35
2.35
BRI-16

BRI-18

BRI-19

BRI-22

BRI-23

BRI-18D

BRI-24

BLOCOUT-INLOC

ABUS

BRICARD

LAT.

JMA

LAT.

7.4
2.4
BRI-25

BRI-27

8.2
2.83
BRI-26

3.5
BRI-28

2.85
BRI-29

3.5
BRI-31

3.5
BRI-33

3.5
BRI-34

8.2
2.83
BRI-30

LAT.

BRICARD

BRUMME

BSS

LAT.

JMA

LAT.

JMA

LAT.

JMA

LAT.

JMA

BRI-32D

BRU-1

BRU-1D

FANA

BSS-1D

BSS-2

BSS-2D

BANE SEKULIĆ

BANE SEKULIĆ



BSS

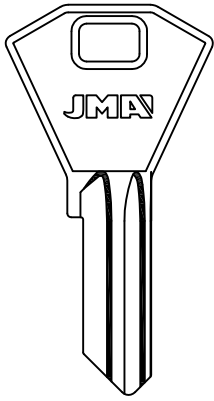

BSS-3

BANE SEKULIĆ

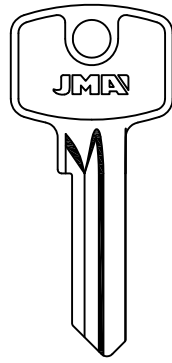

BSS-4D

BANE SEKULIĆ

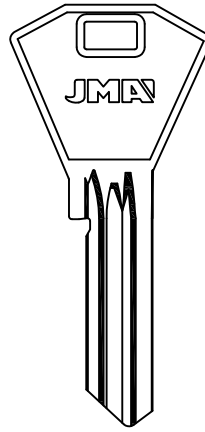

BSS-5D

BANE SEKULIĆ-GE GE

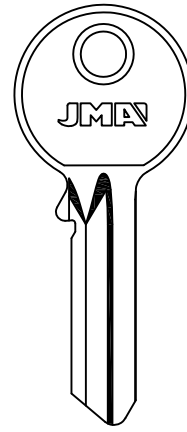

BSS-6D

BANE SEKULIĆ

LAT.

PARA-FOR:

BSS (SCG)

BTV (E)

BUGA (D)

BULAT (RUS)

BTV

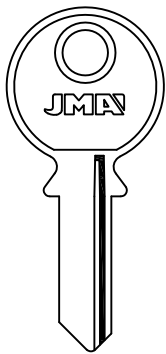

BTV-1I

BTV-1D

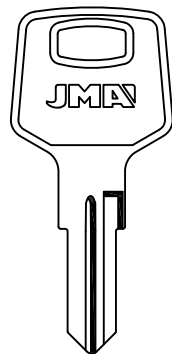

BTV-2I

BTV-2D

SADV

BTV-3

BUGA

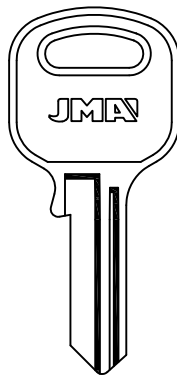

BAI-6

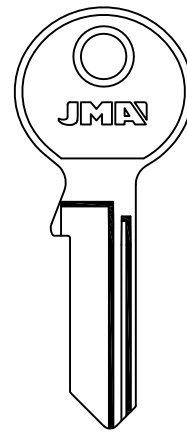

BAI-7

BULAT

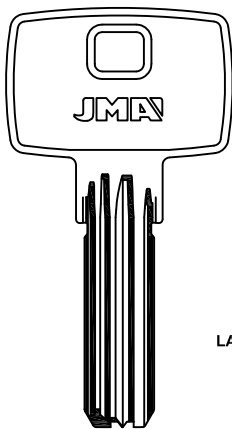

LAT.

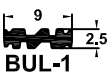

BUL-1

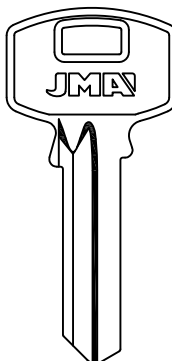

BUL-2D

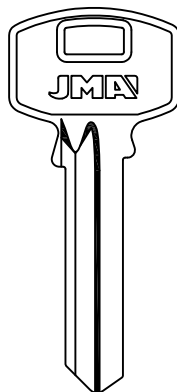

BUL-3D

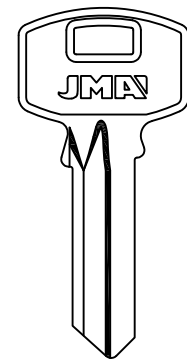

BUL-4D

BUL-6D



PARA-FOR:

BULAT (RUS)

BURG (D)

BULAT		BURG	
		 1/91/9... 0 AL 6	 1/91/9... 0 AL 6
BUL-5D	BUL-7D	BUR-11	BUR-1D
		BUR-27D	BUR-21
			BUR-2D
			MELSMETALL

BURG

BUR-3	BUR-3D	BUR-4	BUR-4D	BUR-5	BUR-5D	BUR-6
						MELSMETALL

BURG

	 1/91/9... 0 AL 6		 ATL-BURGWACHTER-BUVA-HEWY DURABLE-HOPPE-RITTAL-WSM		 CIBOX-HOPPE-KIND-ROTO
BUR-7	BUR-8D	BUR-9	BUR-9D	BUR-10	BUR-10D



BURG

PARA-FOR:

BURG (D)

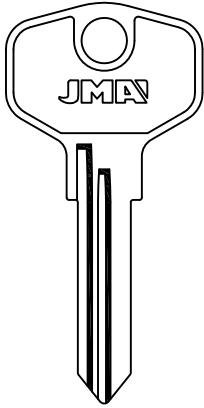

 BUR-11D

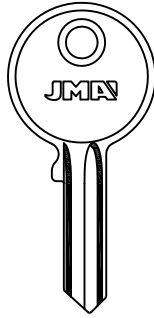

 BUR-12

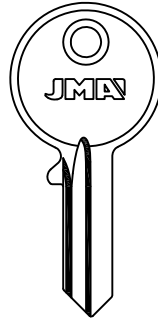

 BUR-13D

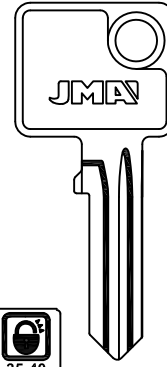

 BUR-14

 BUR-14D

222 C40

 BUR-19D

ANKE-BURG WACHTER

DESAL

ITEM-RITTAL

BURG

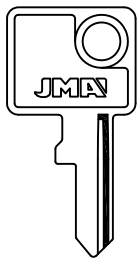

 BUR-15

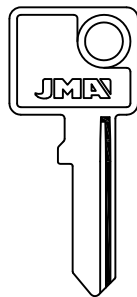

 BUR-16

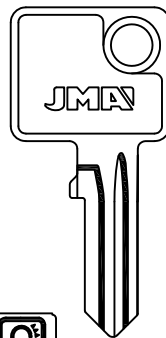

 BUR-17

 BUR-17D

222 C30

 BUR-20D



 BUR-18D

BURG

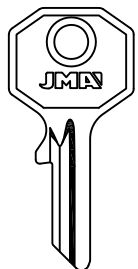

 BUR-21D

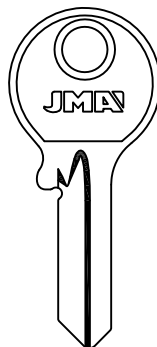

 BUR-22D

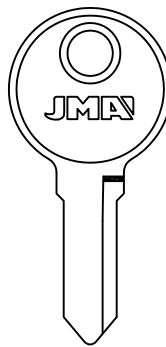

 BUR-24

 BUR-24D

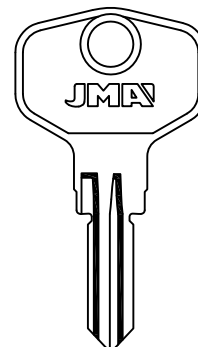

 BUR-25D

JMA[®]

Copyright by Alejandro Altuna S.A. 2014



ATENCIÓN: Concerniente a las marcas y denominaciones comerciales ver nota en índice.

ATTENTION: Concerning the marks and commercial denominations see note in index.

ATTENTION: Concernant les marques et dénominations commerciales voir la note dans l'index.

ACHTUNG: Beziehen auf die marke und handelsname sehen sie die notiz im index.

PARA-FOR:

- BURG (D)
- BUS (D)
- BUVA (D)
- CAB (I)
- CAM LOCK (USA)
- CARTERO (E)

BURG

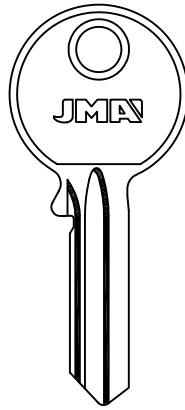

LAT.



BUR-26D

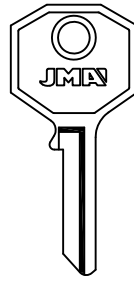

LAT.

BUR-28

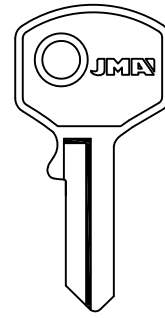

BUR-29

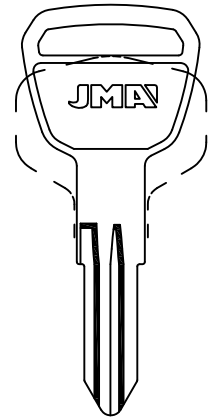

BUR-29D

ZBK 70/74
ZS 85/86
BUR-31D

BURG

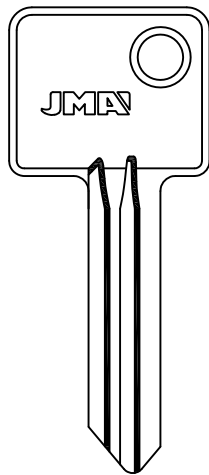

BUR-32D

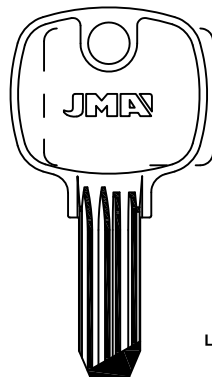

LAT.

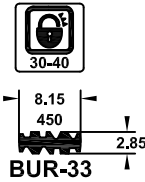

BUR-33

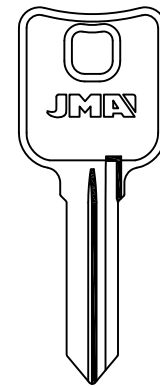

BUR-34

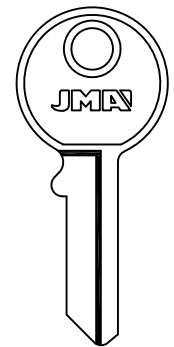

BUS-1

KROST

BUVA

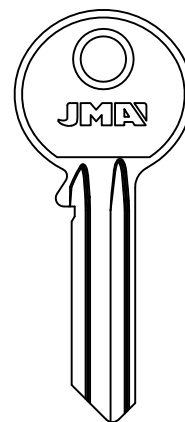

BU-11 BU-1D

CAB

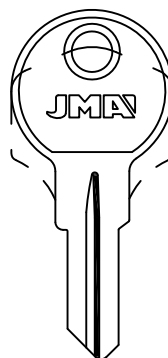

LAT.

CAB-1D

CAM LOCK

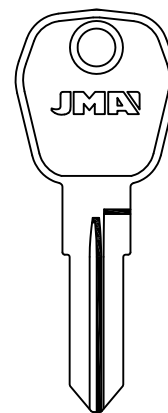

LAT.

CML-1

CARTERO

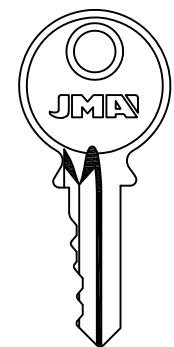

C

AGA-FAC-ST5



CARTERO

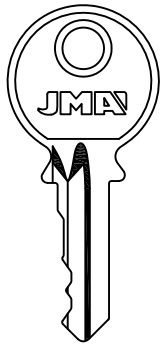

ABSA

CAS CISMA

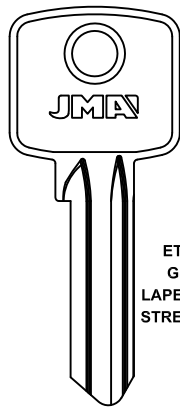

ETNA
GSA
LAPERCHE
STREMLER

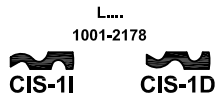

L....
1001-2178

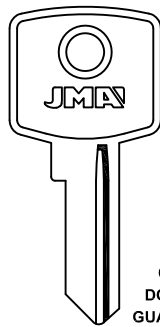

BY
CAB
DOMUS
GUARDIAN
MST
SISO
STIQAM
TESTA



CIS-2



CIS-3

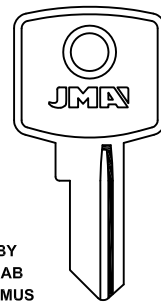

BY
CAB
DOMUS
GUARDIAN
MST
SISO
STIQAM
TESTA



CIS-4



CIS-5

LAT.

PARA-FOR:

- CARTERO (E)
- CAS CISMA (I)
- CASH BOX (D)
- CAVERS (F)

CAS CISMA

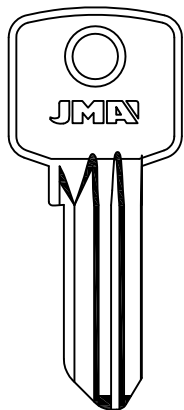

LAT.



CIS-6D



CIS-7D

KP2

CASH BOX

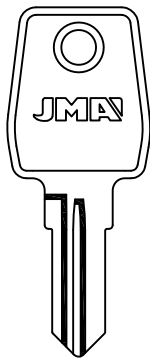

CSB-1D



CSB-2D

0-1-2

ARREGUI-FAC-JOMA

CAVERS

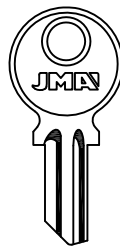

CA-1I

CITY

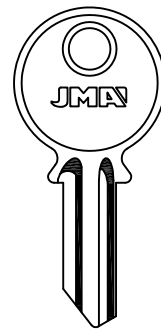

CA-2I



CA-10I

CITY-ZENICA

CAVERS

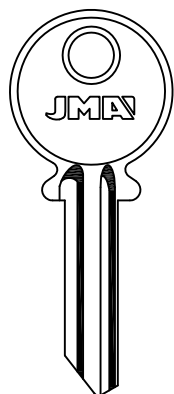

CA-3I



CA-9I

CITY-KVR

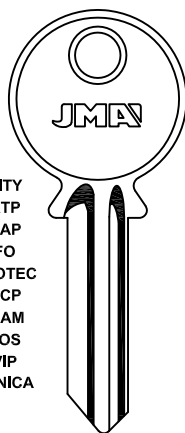

CITY
ATP
CAP
FO
PROTEC
QCP
SIAM
SOS
VIP
ZENICA



CA-4I



CA-12I



CA-4D

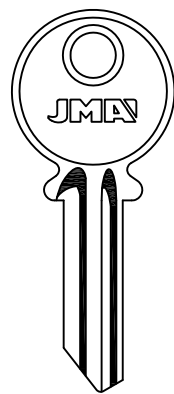

CA-5I



CA-11I

ZENITH-ZENICA

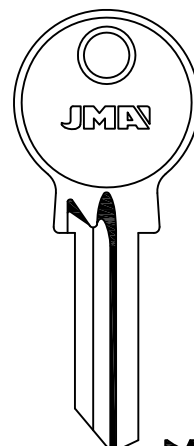

CA-6D



CA-13D

ZENITH-ZENICA



PARA-FOR:

- CAVERS (F)
- CAYS (E)
- CEMA (I)
- CENTURY (GB)
- CERRAMARC (E)

CAVERS

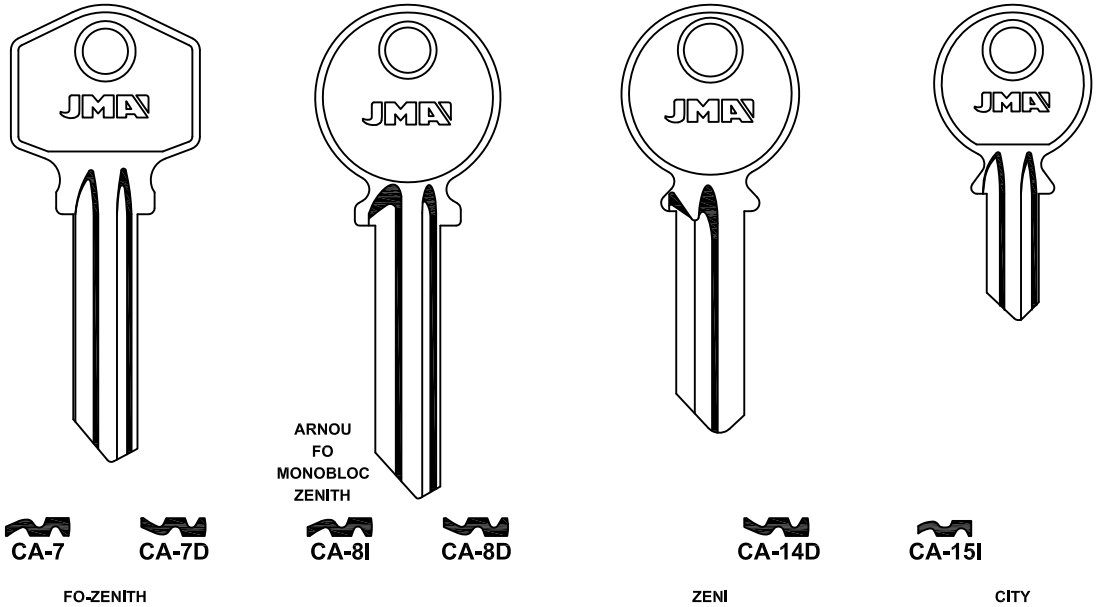

CAYS

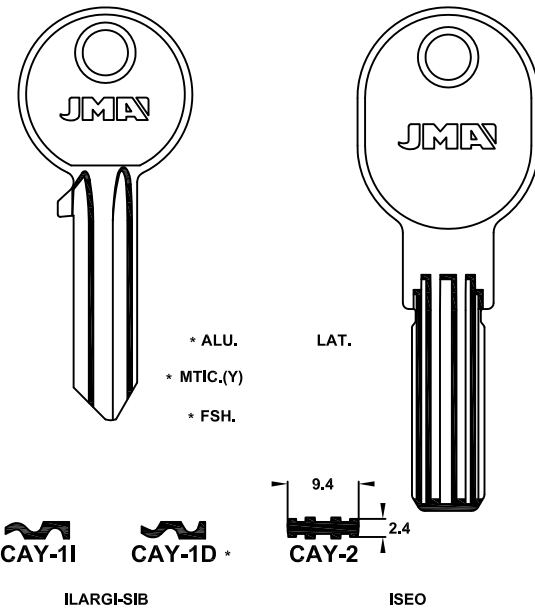

CEMA

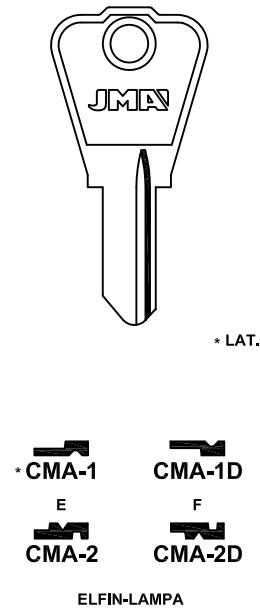

CENTURY

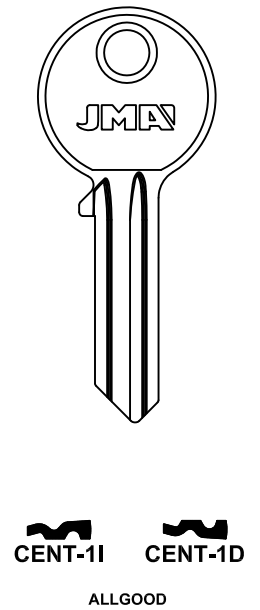

CENTURY

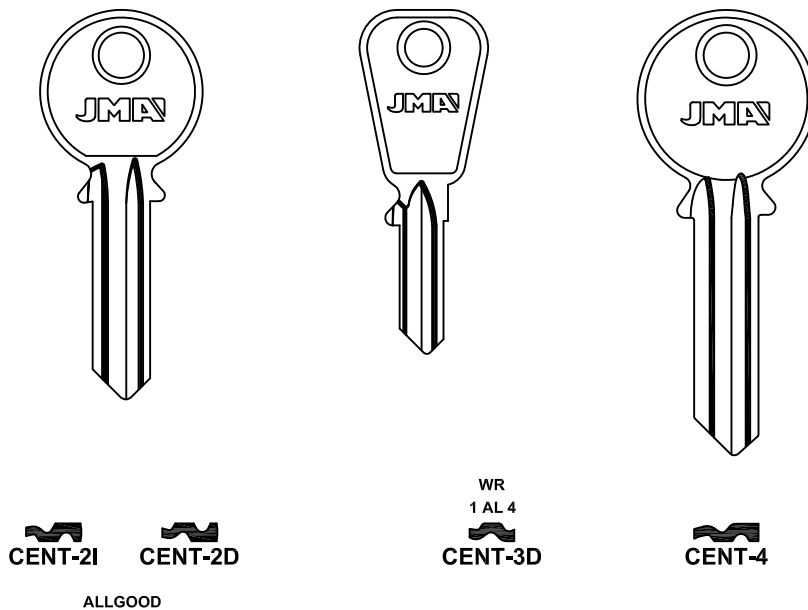

CERRAMARC

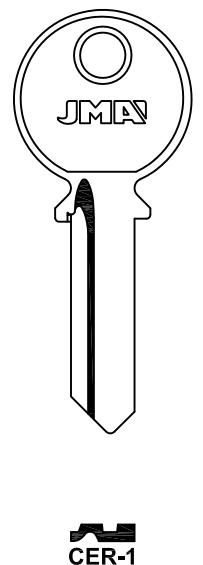

CES

PARA-FOR:

CES (D)

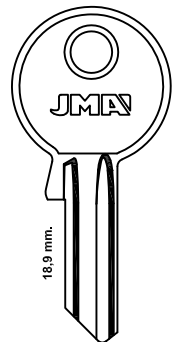

CE-1I

CE-1D

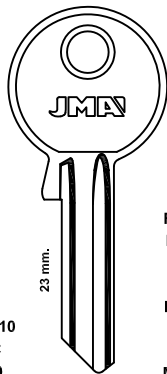

1C
401-410
10C
1-10
HLV
911-950
BODA
ELZETT
FRECOV
KNAPP

CE-2I

CE-2D

ELZETT
FRECOV
HAFELE
HANNO
JOSTA
KARDEX
KIND
KNAPP
MAUSER
NEMEF
OJMAR
SANTIS
VOKO
WASO
WECO

CE-110

CE-108

CE-101D

CE-100D

CE-99D

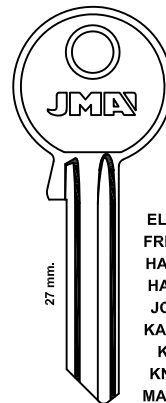

BODA
ELZETT
FRECOV
KNAPP

CE-3I

CE-3D

ELZETT
FRECOV
HAFELE
HANNO
JOSTA
KARDEX
KIND
KNAPP
MAUSER
NEMEF
OJMAR
VOKO
WASO
WECO

STUV

CES

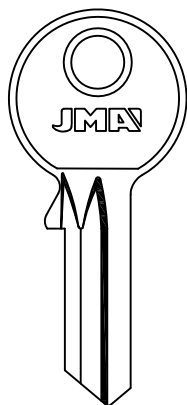

CE-4D

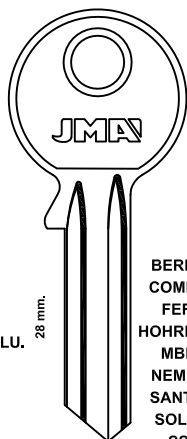

CE-5

CE-5D

BERRY
COMBA
FEFI
HOHRMANN
MBB
NEMEF
SANTIS
SOLID
SS
STUV
TRITON

CE-92

CE-92D

CE-93D

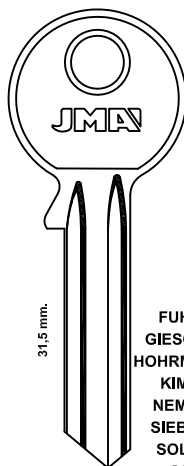

SOLID
CE-6I

CE-6D

FUHR
GIESCHE
HOHRMANN
KIMA
NEMEF
SIEBAU
SOLID
SS
STUV

CE-7I

CE-7D

*CE-7D

CE-8D

*MTIC.

CASMA-SPEEDAL

NEMEF

CES

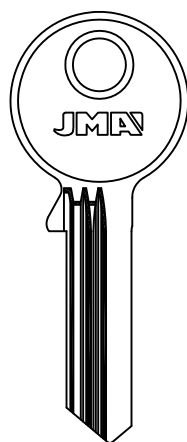

X23
CE-9D

X24
CE-10D

X25
CE-11D

X26
CE-12D

X27
CE-13D

X28
CE-14D

X29
CE-15D

X30
CE-16D

X31
CE-17D

X32
CE-18D

X33
CE-19D

X34
CE-20D

X35
CE-21D

X36
CE-22D

X37
CE-23D

X38
CE-24D

X39
CE-25D

X40
CE-26D

X41
CE-27D

X42
CE-28D

W23
CE-29D

W24
CE-30D

W25
CE-31D

W26
CE-32D

W27
CE-33D

W28
CE-34D

W29
CE-35D

W30
CE-36D

W31
CE-37D

W32
CE-38D

W33
CE-39D

W34
CE-40D

W35
CE-41D

W36
CE-42D

W37
CE-43D

W38
CE-44D

W39
CE-45D

W40
CE-46D

W41
CE-47D

W42
CE-48D

CE-118D

SOLID

JMA[®]

Copyright by Alejandro Altuna S.A. 2014



ATENCIÓN: Concerniente a las marcas y denominaciones comerciales ver nota en índice.

ATTENTION: Concerning the marks and commercial denominations see note in index.

ATTENTION: Concernant les marques et dénominations commerciales voir la note dans l'index.

ACHTUNG: Beziehen auf die marke und handelsname sehen sie die notiz im index.

PARA-FOR:

CES (D)

CES

33 mm.

1Z...1-100000

33 mm.

16

CE-50

26
CE-55

27
CE-56

28
CE-57

15
CE-77

17
CE-78

18
CE-79

25
CE-80

35
CE-81

36
CE-82

37
CE-83

38
CE-84

45
CE-85

46
CE-86

47
CE-87

48
CE-88

CE-49

CE-49D

CE-51

CE-51D

CE-52

BODA

LAT.

CES

31,5 mm.

LAT.

A5
CE-61

A4
CE-60

A3
CE-59

A2
CE-58

A1
CE-54

B5
CE-66

B4
CE-65

B3
CE-64

B2
CE-63

B1
CE-62

C5
CE-71

C4
CE-70

C3
CE-69

C2
CE-68

C1
CE-67

D5
CE-76

D4
CE-75

D3
CE-74

D2
CE-73

D1
CE-72

K
CE-90D

CE-53D

HÄFELE

BODA

CES

* LAT.

LAT.

CE-89

CE-89D

CE-94

* CE-133

CE-96

CE-97



CES

PARA-FOR:

CES (D)

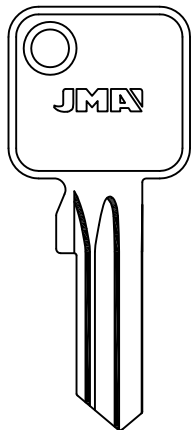

CASMA-SPEEDAL

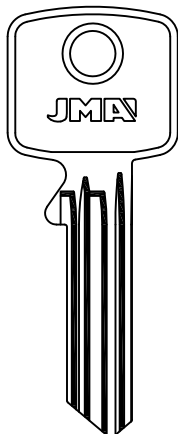

NEMEF

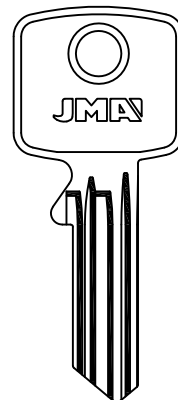

CES

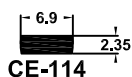
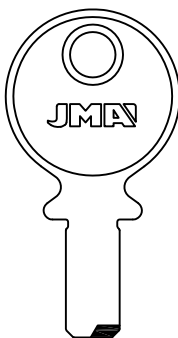
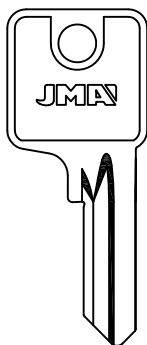

LAT.

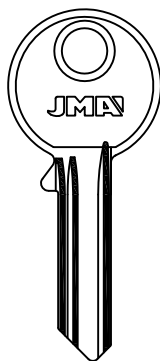

WS 401-410

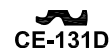
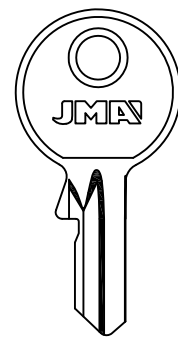

CES

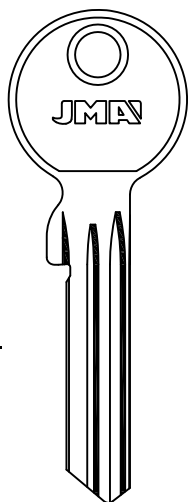

LAT.

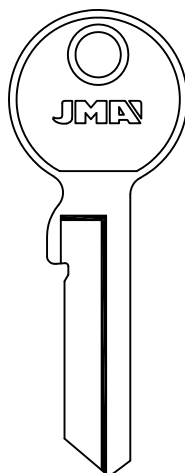
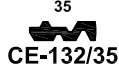
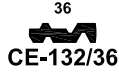
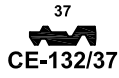
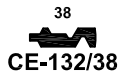
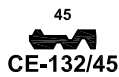
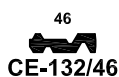
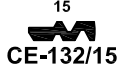
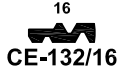
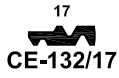
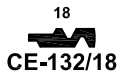
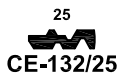
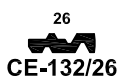

CE-134

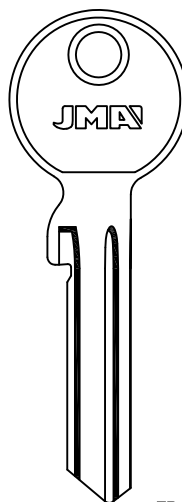

ALP.

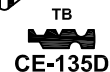









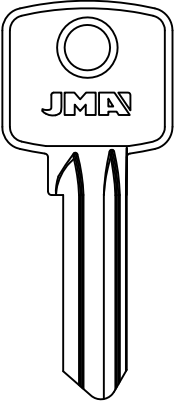
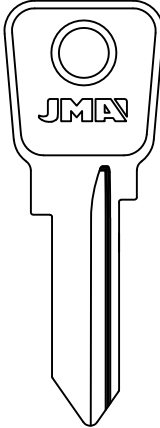
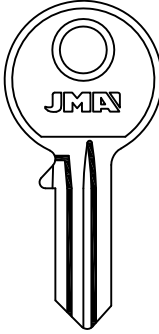
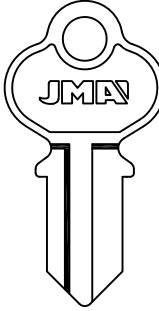

CE-135D









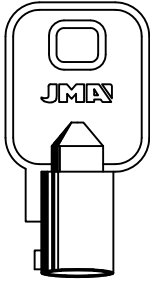
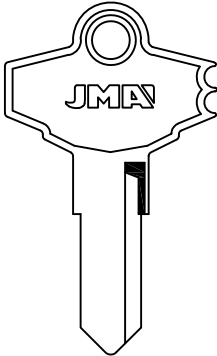
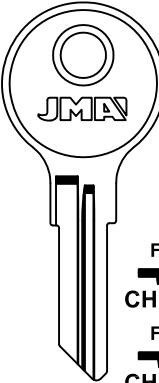
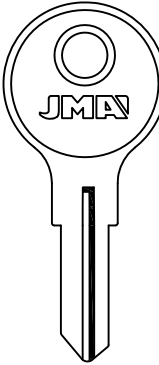

PARA-FOR:

- CHAVO (P)
- CHELIABINSK (RUS)
- CHEYLOCK (HK)
- CHICAGO (USA)
- CHUBB (GB)
- CIEF (F)
- CIELS (F)

CHAVO	CHELIABINSK	CHEYLOCK	CHICAGO
			
 CHA-2	 CHTZ-1	 CHEK-1	 CHI-1  CHI-2  CHI-3  CHI-4  CHI-5 







CHICAGO

			
 CHI-1T ACE-ADEMCO-AGA-ALPHA EURO LOCKS-FORT-GEM-L & F	 CHI-6 ILLINOIS ODA	 FR CHI-7D  FR CHI-8D  XF CHI-9D  XF CHI-10D	 CHI-12D

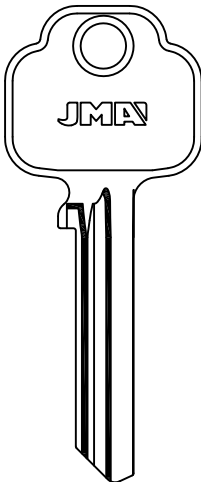
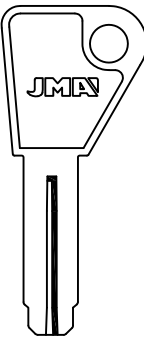
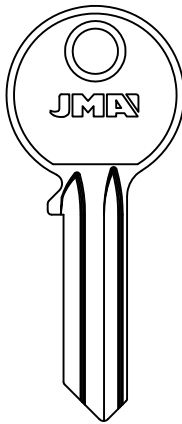
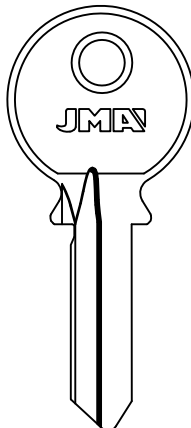
CHUBB

CIEF

CIELS

			
 CHU-1D	 CHU-10 AVA-CHUBB	 CF-1  CF-1D ESAFE-FEB	 CIE-1D



CIFIAL

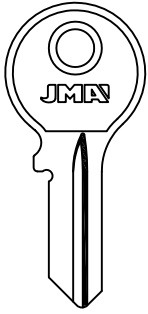

CIF-1D

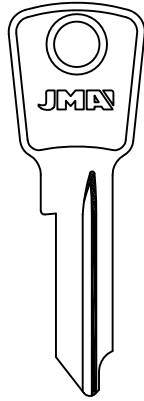

CIF-2D

LEFEBURE

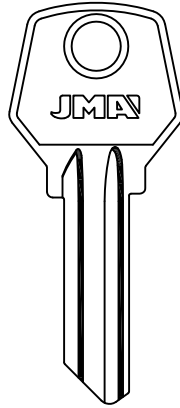

CIF-3

CIF-3D

EFER

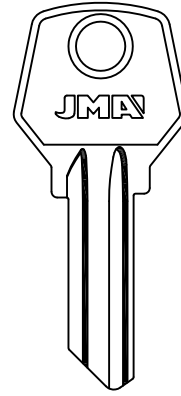

CIF-4

EFER

PARA-FOR:

CIFIAL (P)

CILA-GENTILI (I)

CINA (RC)

CISA (I)

CILA-GENTILI

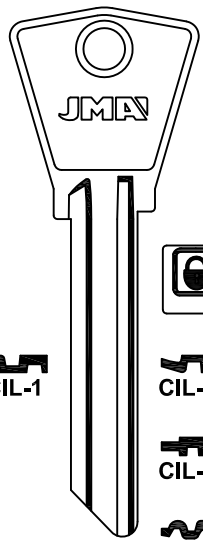

CIL-1



CIL-1D

CIL-2D

CIL-3D

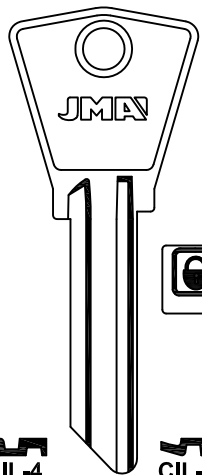

CIL-4



CIL-4D

CIL-5D

CINA

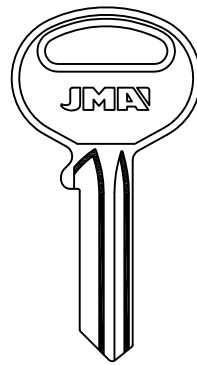

ALI-1

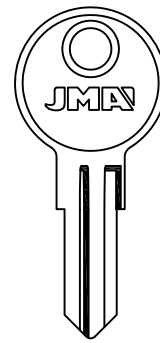

CIN-1

CIN-1D

CINA

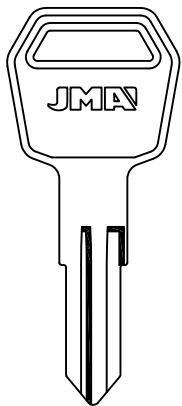

CIN-2

CIN-2D

CISA

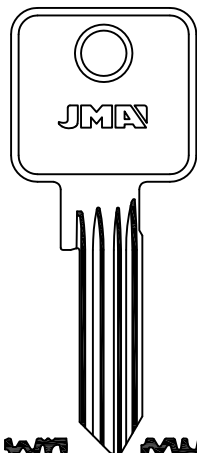

CI-11

CI-1D

CI-39D

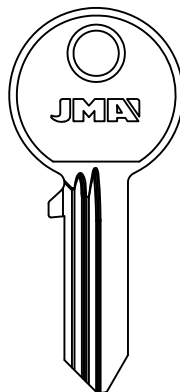

CI-3D

CI-4I

CI-4D

TZAFRER

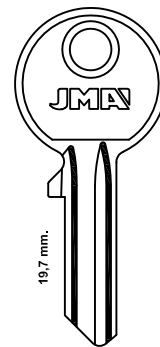

19,7 mm.



CI-4IP



CI-4DP

ABUS



PARA-FOR:

CISA (I)

CISA

23.2 mm.
40
.....1 AL 6

CI-5IP CI-5DP

7.35
2.35
CI-14

CI-6I *CI-6D

7.35
2.35
CI-14

CI-7D CI-17

A/AZIZA/Z.....
000001-030198

BATU-KUNERT JPM ABUS-ASTRAL-BRICARD

ABUS
CHAVO
ESCO
ESSENDIA
ITO
GEFI
GETE
GTV
NB
SCHUCO
STANDARD

*MTIC.

LAT.

CISA

CI-19D

CI-20

CI-20D

8.17
2.82
CI-21

CI-31 CI-60
CI-32 CI-67
CI-33
CI-25 CI-35
CI-26 CI-56
CI-30 CI-59

LAT.

ABUS-ASTRAL-AXIS

CISA

CI-22D

.....1 AL 6
CI-23D

CI-24

CI-28D

ABUS ABUS

LAT.



CISA

PARA-FOR:

CISA (I)

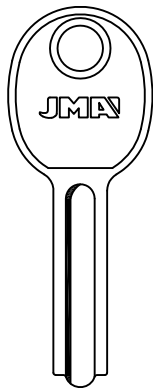

CI-41

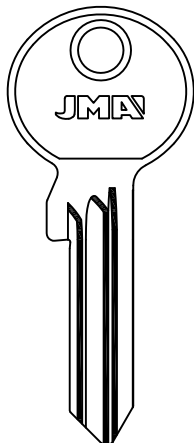

A
CI-43D

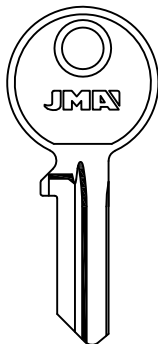

CI-45D

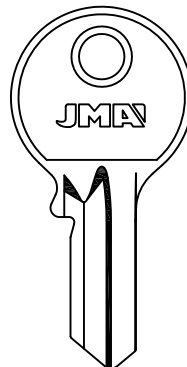

CI-46D

ABUS

CISA

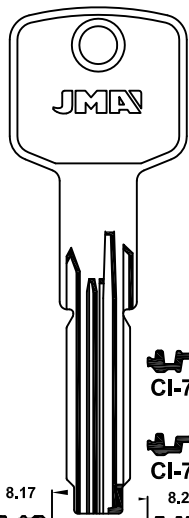

LAT.

8.17
2.98
CI-48

ABUS

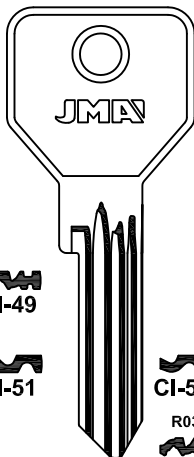

CI-49

CI-51

R032
CI-61

CI-51D

R033
CI-55D

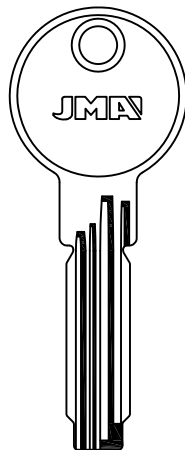

LAT.

8.2
2.85
CI-57

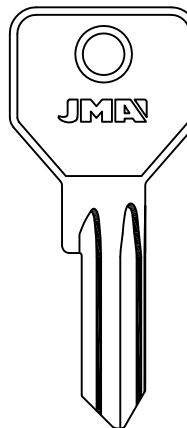

CI-62

CI-62D

CISA

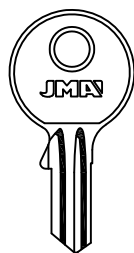

CI-65

ABUS-ALA

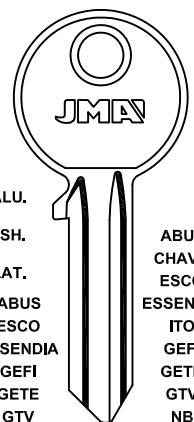

ALU.

* FSH.

* LAT.

ABUS

ESCO

ESSENDIA

GEFI

GETE

GTV

NB

SCHUCO

STANDARD



50-60

CI-1L

** CI-DL

ABUS

CHAVO

ESCO

ESSENDIA

ITO

GEFI

GETE

GTV

NB

SCHUCO

STANDARD

TREE

CI-21

20
CI-9D

04-05-07
CI-11D

33
CI-13

CI-15

R002
CI-18

R005-19
CI-29

A
CI-2

02
CI-8D

08
CI-10D

11
CI-12

CI-15D

CI-16D

CI-27

CI-34

R007
CI-36

CI-38D

CI-42

CI-53

CI-63

CI-34D

CI-70

CI-69

* CI-66D

CI-64D

CI-63

CI-63D



PARA-FOR:

CLARK FORK LIFT
(USA)











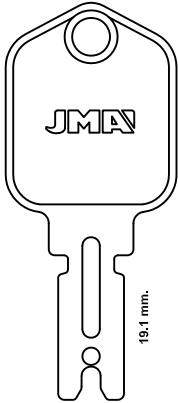

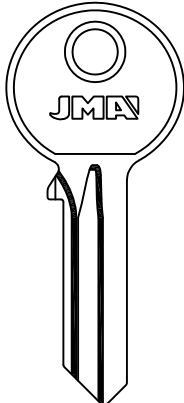

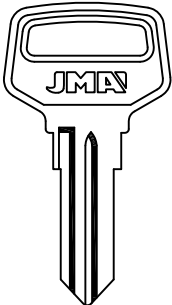
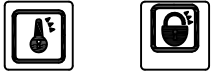

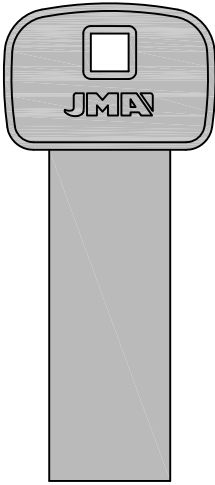

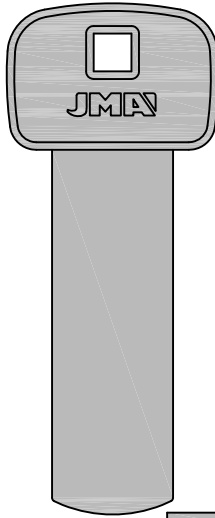

CLASSIC

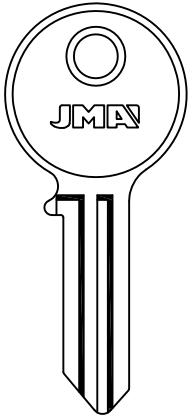
CLAUSOR (E)

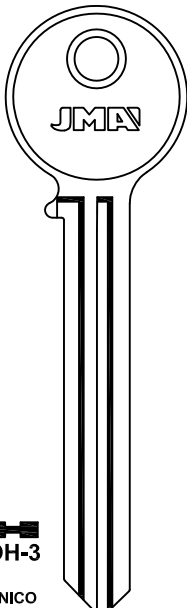
CLEMSA (E)

COHNKO (RUS)

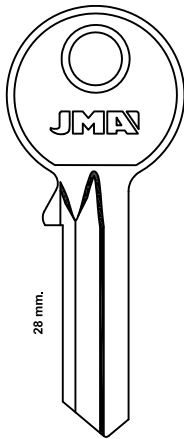
COM (D)

CLARK FORK LIFT	CLASSIC	CLAUSOR
 <p>19.1 mm. LAT.</p>  <p>CLF-1 YALE</p>	  <p>CLS-1D</p>	 <p>ALU.</p>   <p>CL-1I BRABANTIA</p>
CLEMSA		COHNKO
    <p>MG-6I MG-6S MG-6D</p>	 <p>PLAS.</p>  <p>MG-9</p>	  <p>COH-1</p>  <p>COH-2 COH-2D</p> <p>SONICO</p>
COHNKO		COM
  <p>COH-3 SONICO</p>	  <p>COH-4</p>	 <p>28 mm.</p>  <p>COM-1D</p>



CORBIN

PARA-FOR:
CORBIN (I)

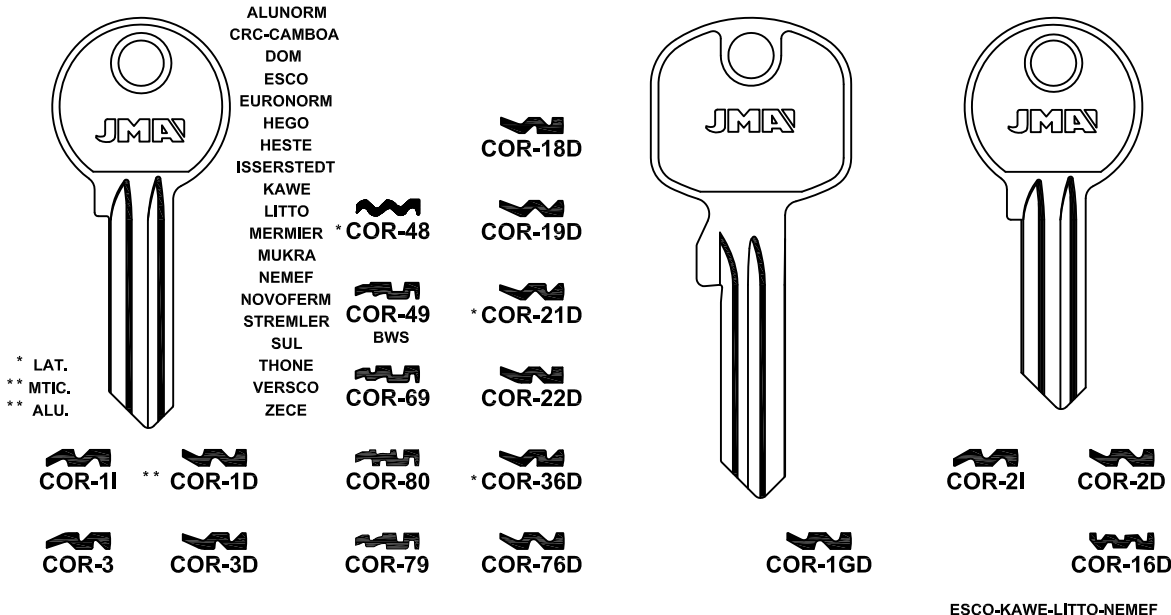

CORBIN

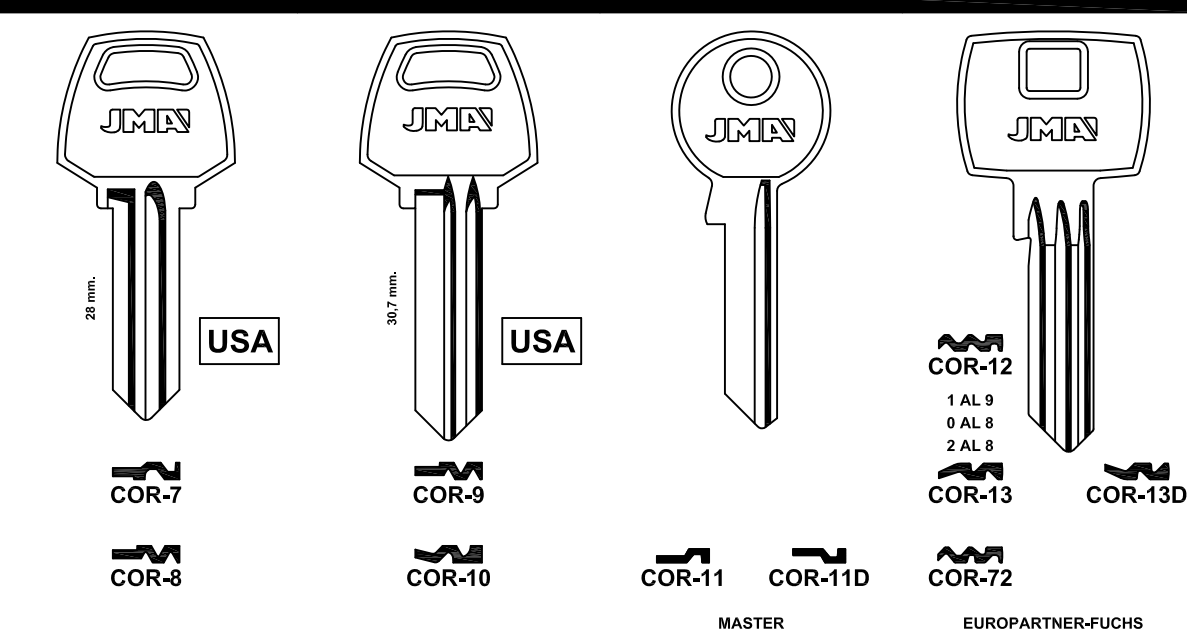

CORBIN

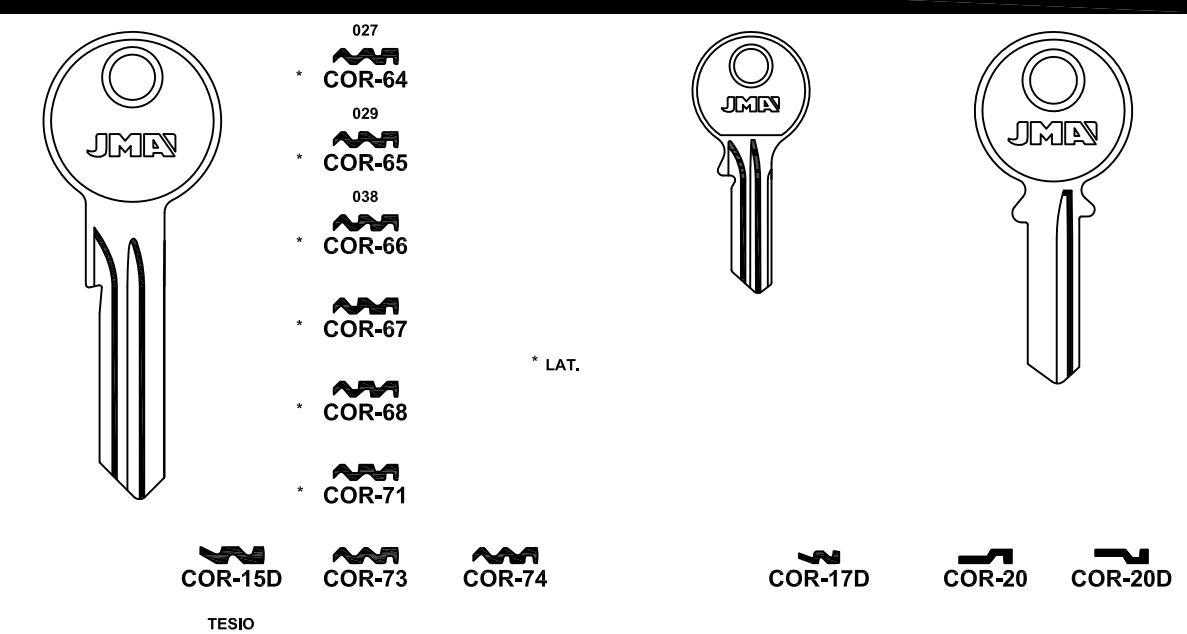

PARA-FOR:

CORBIN (I)

CORBIN

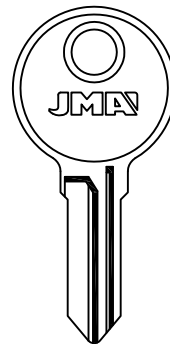
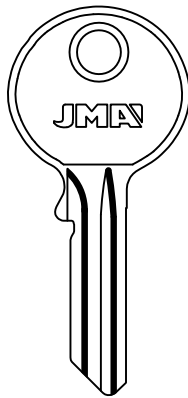
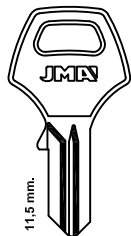

CHANGE-O-MATIC

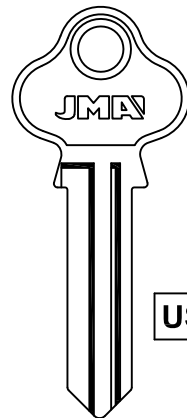

SKILMANN

CORBIN

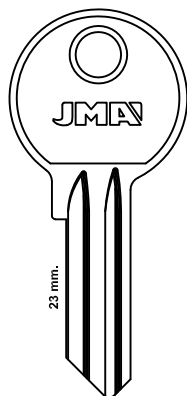

ESCO-EURONORM-KAWE-MUKRA

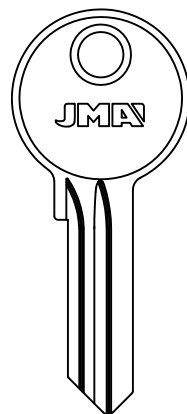
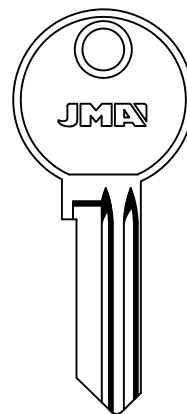
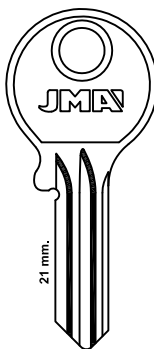

CORBIN

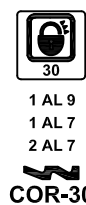
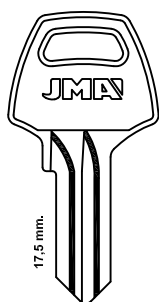

1 AL 9
1 AL 7
2 AL 7

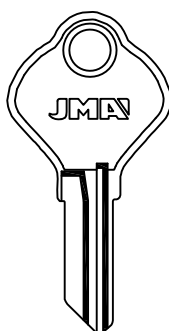

CCL

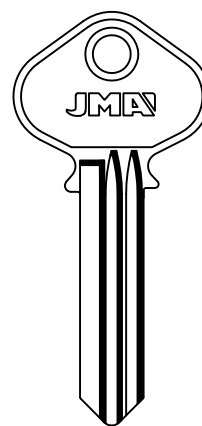
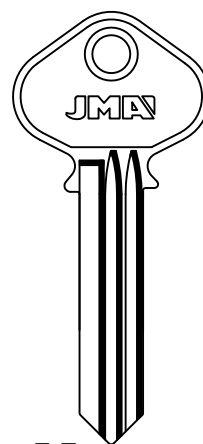

CORBIN

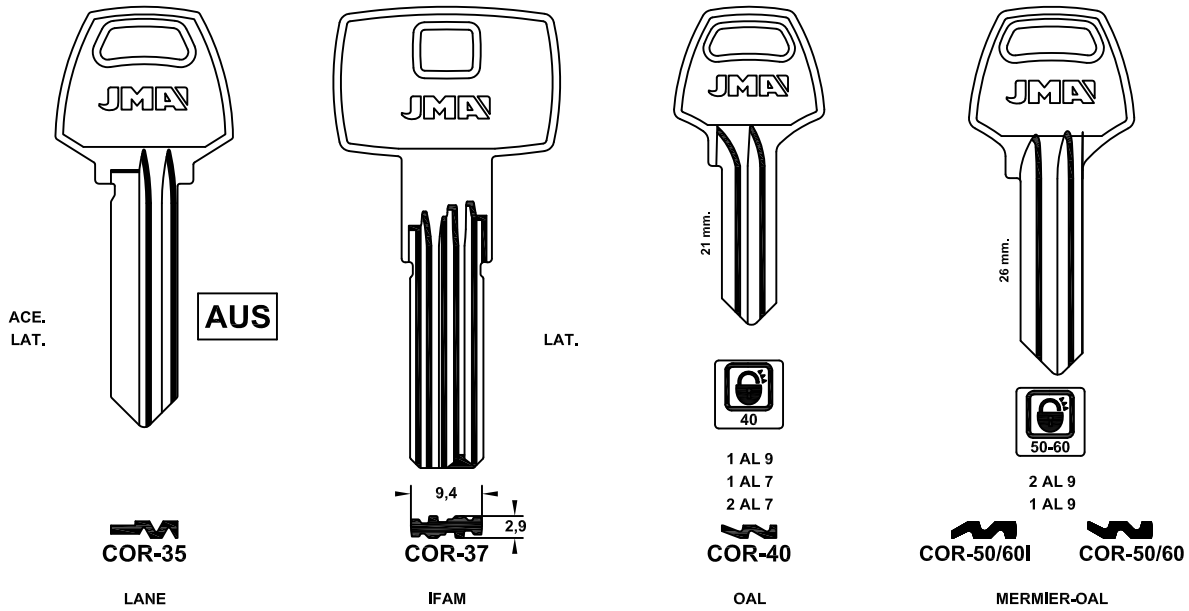

CORBIN

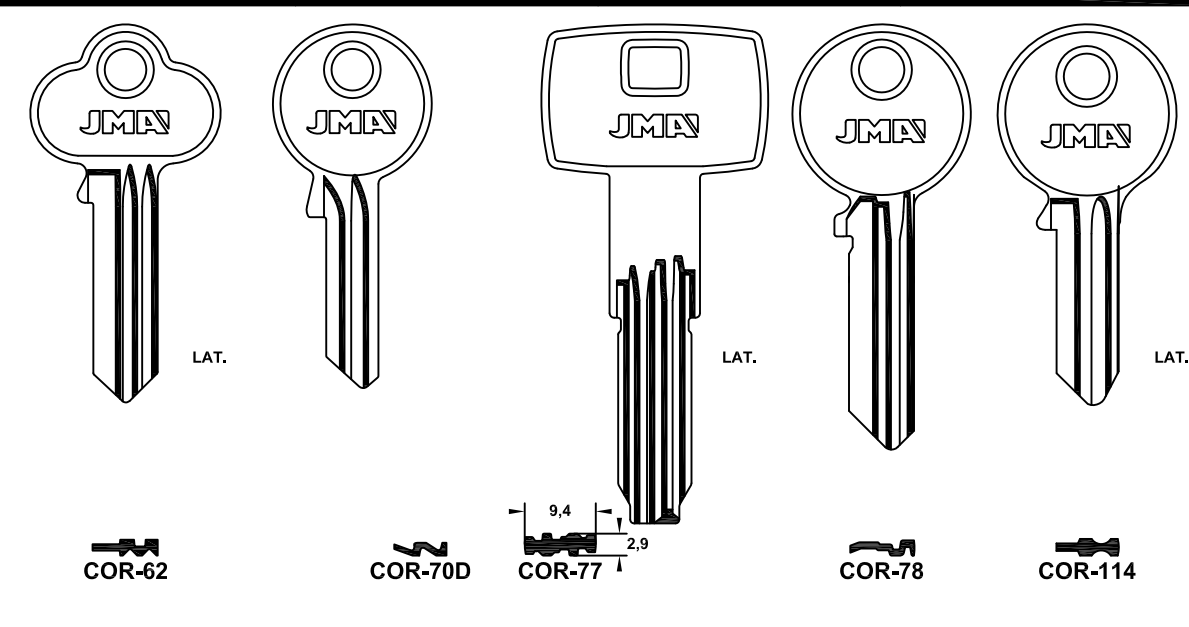

CORBIN

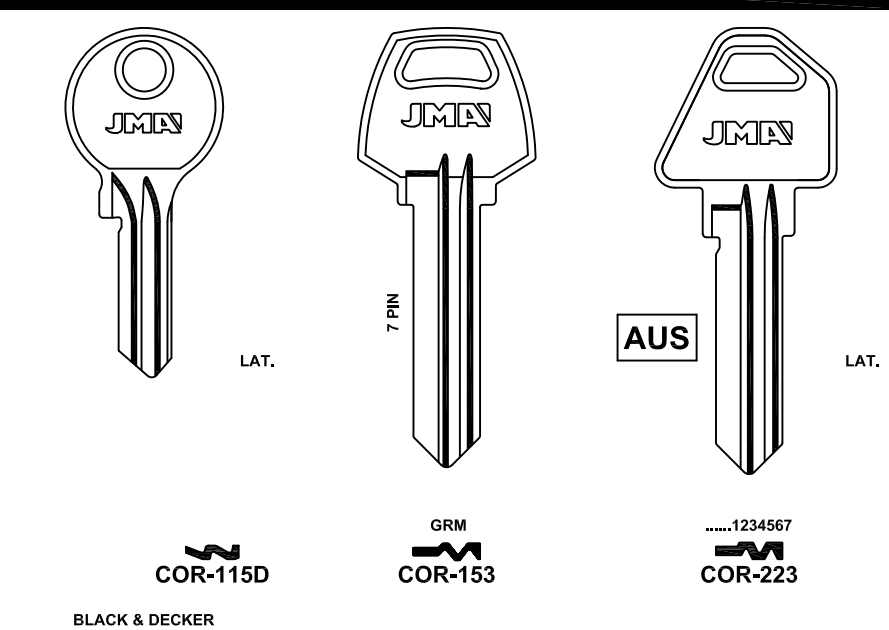

CORONA

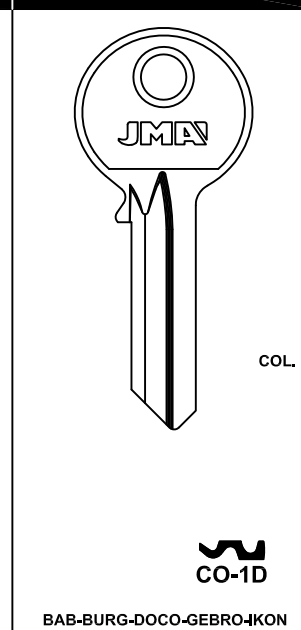

PARA-FOR:





CORBIN (I)

CORONA (D)



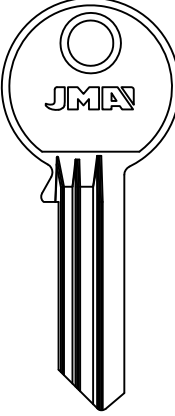
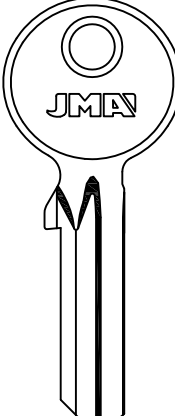
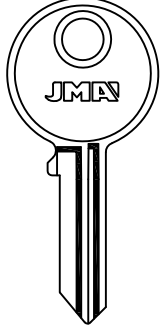
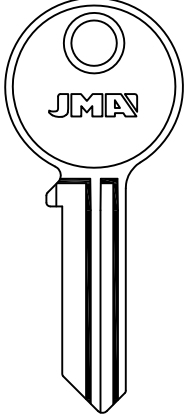





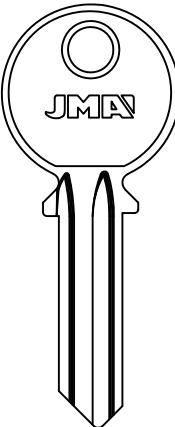
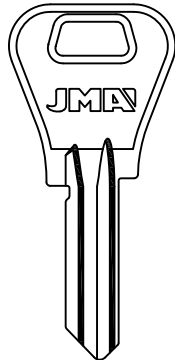
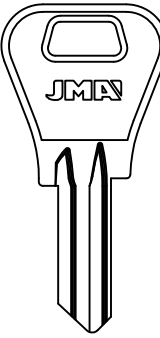
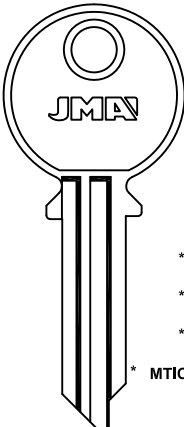

PARA-FOR:

- CORONA (D)
- COTICO (D)
- CRAZY LOCKS (RC)
- CUBELLS (E)
- CVL (E)
- DAD (F)











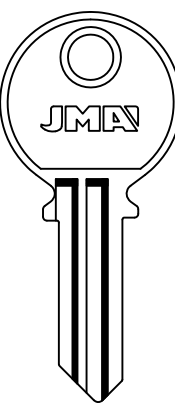
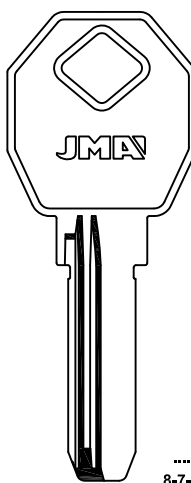
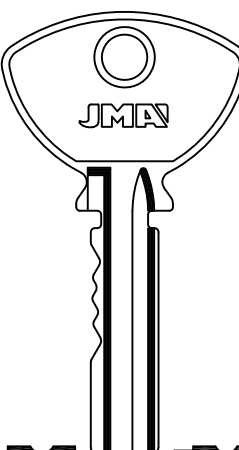
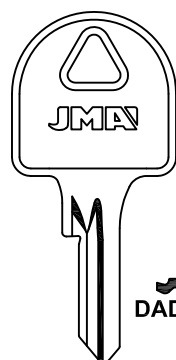

CORONA	COTICO	CRAZY LOCKS	CUBELLS
			
 M CO-M IKON	 COT-1D	 CLK-1	 CUB-1

CVL

			
LAT. ALU.	LAT. ALU.		* FSH. * LAT. * ALU. * MTIC.(D-C)
 CVL-1I	 CVL-1D	 CVL-2I	 CVL-2D
SERRALLER		UCEM	
 CVL-3I	 CVL-3D	 * CVL-5I	 * CVL-5D *
AUMON-CAYS-CAZORLA-EURO FERMOD-JJ-PP-QCM			

CVL

DAD

			
LAT.			
 CVL-6	 CVL-8D	 DAD-1I	 DAD-1D
	IC 8-7-6-5-4-3 8.9 2.4 CVL-9D	 DAD-2I	 DAD-2D
		DECAYEUX	
		 DAD-3D	 DAD-4D
		 DAD-5D	 DAD-6D
		ARFE-DECAYEUX	



DAF

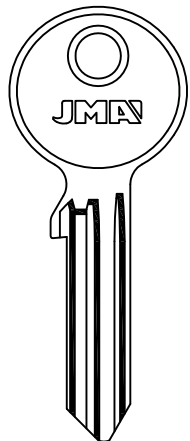

9.2
2.8
DAF-2



DAF-3D



DAF-4D

LAT.

DEFA

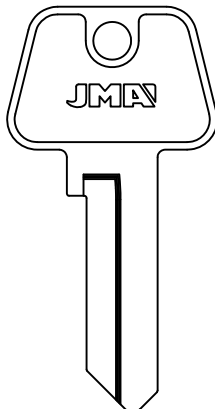

DEF-1D

DEKABA

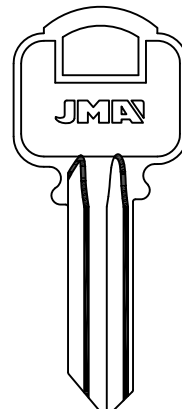

DEK-2



DEK-7D

MAUER

PARA-FOR:

DAF (TR)

DEFA (N)

DEKABA (BG)

DELAPORTE (F)

DEKABA

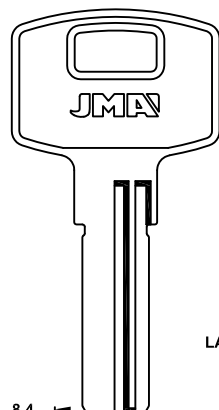

8.4
2.45
DEK-3

E2



DEK-8

MAUER

LAT.

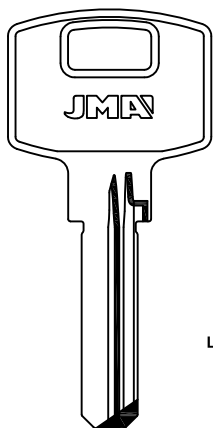

7.2
2.5
DEK-4

MAUER

LAT.

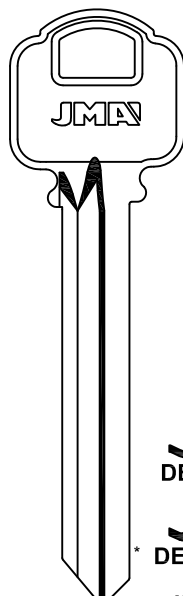

DEK-6D



DEK-14D

MAUER

* LAT.

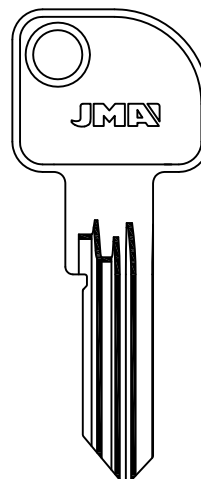

F
DEK-9D

MAUER

DEKABA

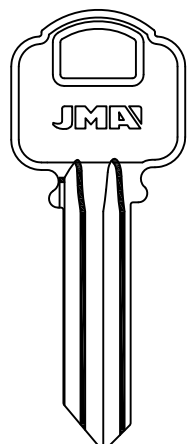

DEK-10

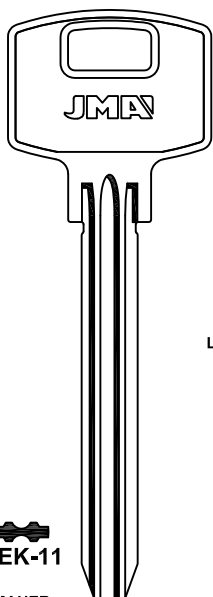

DEK-11

MAUER

LAT.

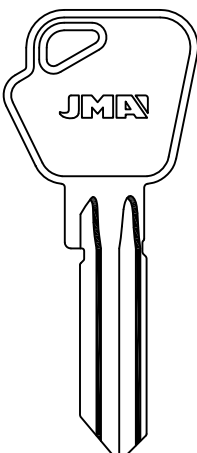

DEK-13

MAUER

DELAPORTE

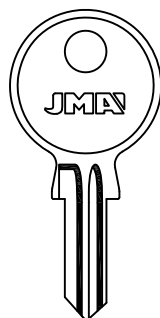

2501-2550













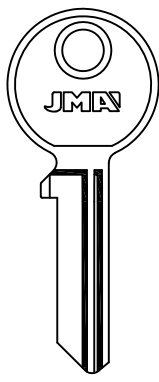

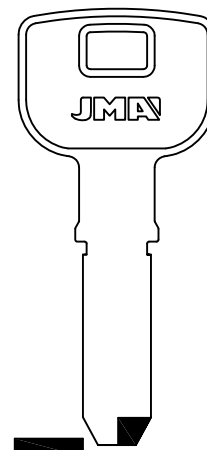

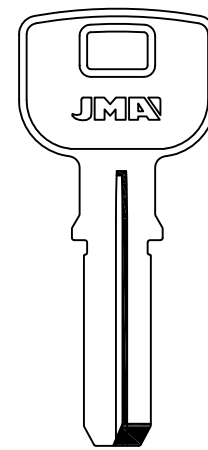

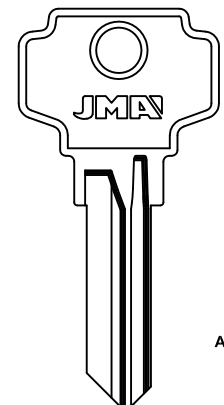

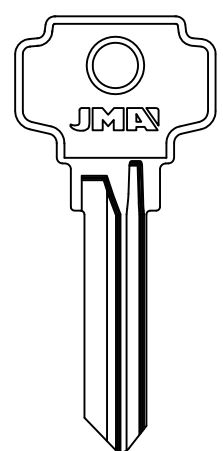

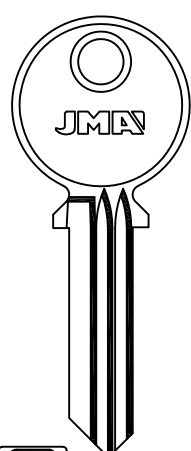

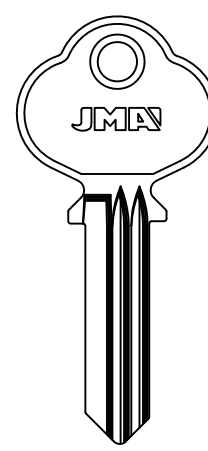

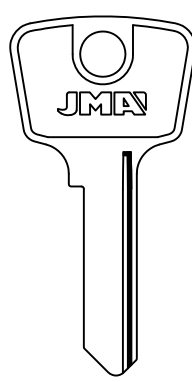
DLP-1

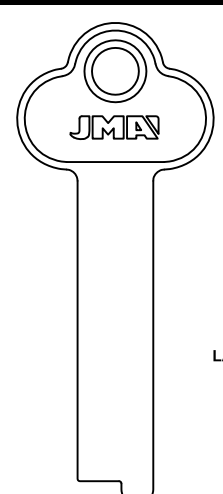
DIRAK-EMKA

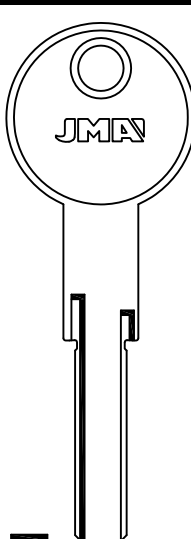

PARA-FOR:

- DELAPORTE (F)
- DELCA (GR)
- DEXTER (I)
- DIAMOND (RC)
- DIEBOLD (D)
- DIERRE (I)
- DIMITROVGRAD (RUS)
- DOM (D)

DELAPORTE	DELCA		DEXTER
  DLP-2	  DLC-1 9 2.4 DLC-2 GEVY	  8.85 2.45 DLC-3 GEVY	 0 AL 7 T 0 AL 9 0 AL 9   DX-5 DX-5D ALU.
DEXTER	DIAMOND		
 0 AL 7 0 AL 9   DX-6 DX-6D	  DIA-1	  DIA-2	  DIA-3
DIEBOLD	DIERRE	DIMITROVGRAD	DOM
  DIE-1	  DR-1 ATRA	  DM-1	 18 mm. * ALU. * LAT. * FSH. BTV DAD ESAFE FECOR HAEFELE HEKNA HUWIL MECALUX METEOR MLM RENZ RUKA SCHLEGEL STS 2D 001-222 5A 0001-2600 9A 0001-5200 1D 601-654   DOM-11 * DOM-1D



DOM

PARA-FOR:

DOM (D)

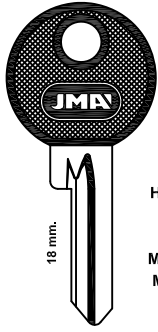

BTV
DAD
ESAFE
FECOR
HAEFELE
HEKNA
HUWIL
MECALUX
METEOR
MLM
RENZ
RUKA
SCHLEGEL
STS

2D 001-222
5A 0001-2600
9A 0001-5200
1D 601-654



DOM-1D.P

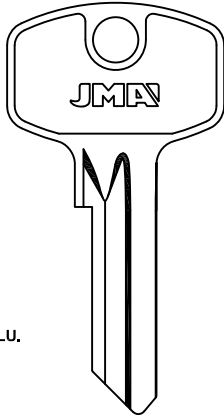

ALU.



DOM-2D

MOREAUX-STUV

C
1301-1500
C
1001-1200
CL
001-250
GP
001-250

DOM-3I

DOM-4



DOM-3D



DOM-4D

DOM-8D

CHRIST

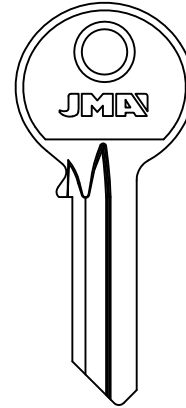

DOM-5D

STEIGA-STUV-VIKI

DOM

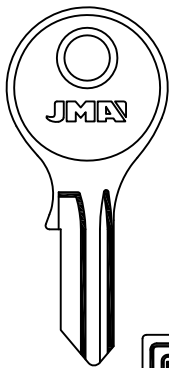

DN
001-120
80138-80728
80761-83242

DOM-6I



DOM-6D

BARRO-IDEAL-TM

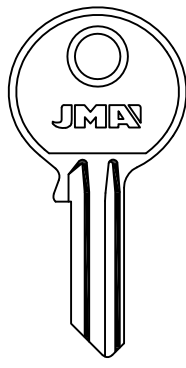

DOM-7I

EV
0001-2840
GD
0001-1000
4C
0001-3000

DOM-7D

HOHRMANN



EV...1-2840

DOM-9



EV...1-2840
GS...1-1000
FT...1-1000
CQ...301-400
...1-1000

DOM-9D

NOBO

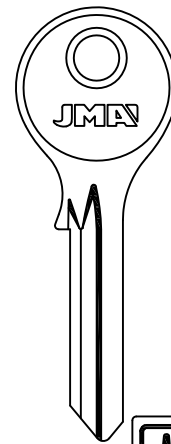

DOM-10D

DOM

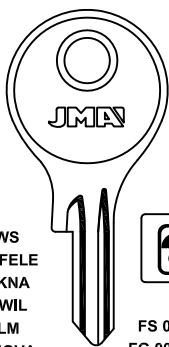

CWS
HAEFELE
HEKNA
HUWIL
MLM
MENOVA
METEOR
RUKA
SINJET
STS

1D 058-114

DOM-11I

FS 01-60
FG 001-615
4A 001-182
3A 01-82
CF 001-140
DB 001-148
2A 01-34
1D 01-57
1D 501-560

DOM-11D

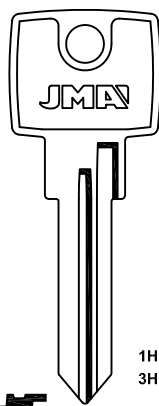

DOM-12

NOBO

1H 0001-4088
3H 0001-0600

DOM-12D
ASPA

DOM-48

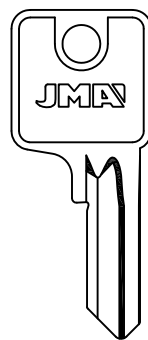

DOM-13D

DC...1-1800
K.. 1-50
GD...1-1800
GZ...1-1800
3E...1-350

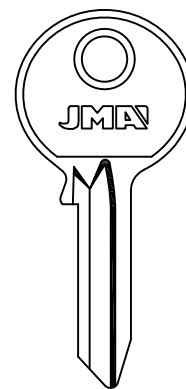

DOM-14D

FA-GZ
0001-3948



PARA-FOR:

DOM (D)

DOM

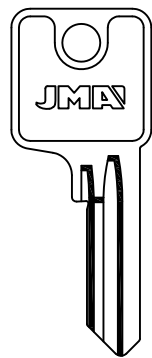

 DOM-15D

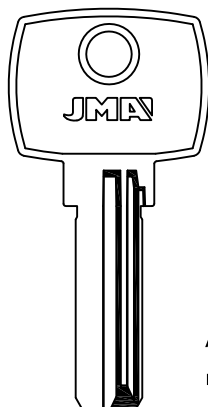

 DOM-16D



 DOM-41D

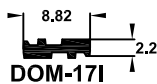

DOM-17I

ALP.
LAT.

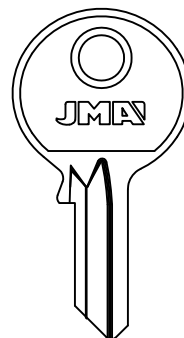

 DOM-18D

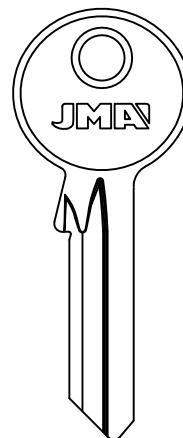

 DOM-20D

CORBIN-EMHART

DOM

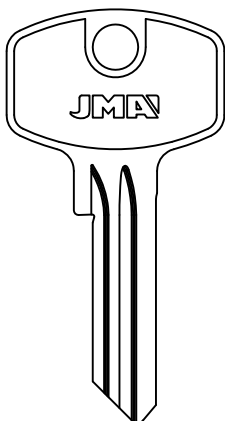

 DOM-21D

CORBIN

 DOM-45

 DOM-46D

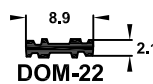
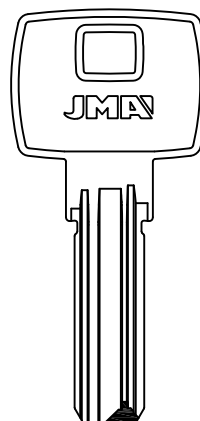

DOM-22

ARCU

ALP.

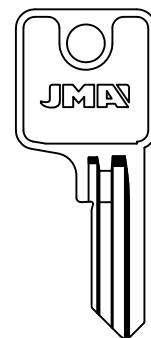

 DOM-25D

 DOM-49D

DOM

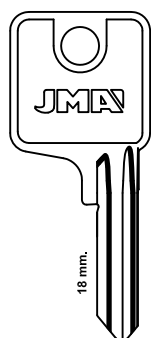

 DOM-26

2D 001-222
5A 0001-2600
9A 0001-5200
1D 601-654

 DOM-26D

LAT.

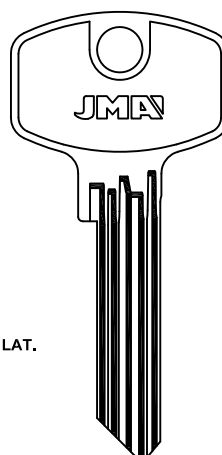

 DOM-27/35

 DOM-27/19

 DOM-27/16

 DOM-27/13

 DOM-27/12



DOM

PARA-FOR:

DOM (D)

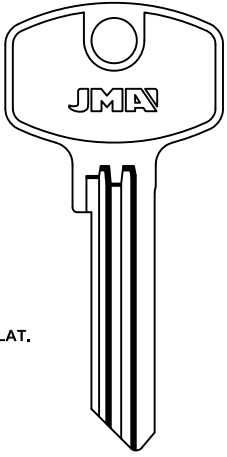

DOM-27D/2	DOM-27D/9	DOM-27D/16	DOM-27D/23	DOM-27D/30
DOM-27D/3	DOM-27D/10	DOM-27D/17	DOM-27D/24	DOM-27D/31
DOM-27D/4	DOM-27D/11	DOM-27D/18	DOM-27D/25	DOM-27D/32
DOM-27D/5	DOM-27D/12	DOM-27D/19	DOM-27D/26	DOM-27D/33
DOM-27D/6	DOM-27D/13	DOM-27D/20	DOM-27D/27	DOM-27D/34
DOM-27D/7	DOM-27D/14	DOM-27D/21	DOM-27D/28	DOM-27D/35
DOM-27D/1	DOM-27D/8	DOM-27D/15	DOM-27D/22	DOM-27D/36

DOM-27D/37	DOM-27D/44	DOM-27D/51	DOM-27D/58
DOM-27D/38	DOM-27D/45	DOM-27D/52	DOM-27D/59
DOM-27D/39	DOM-27D/46	DOM-27D/53	DOM-27D/60
DOM-27D/40	DOM-27D/47	DOM-27D/54	DOM-27D/61
DOM-27D/41	DOM-27D/48	DOM-27D/55	
DOM-27D/42	DOM-27D/49	DOM-27D/56	
DOM-27D/43	DOM-27D/50	DOM-27D/57	

DOM

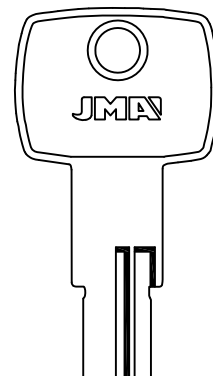
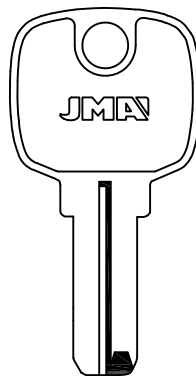
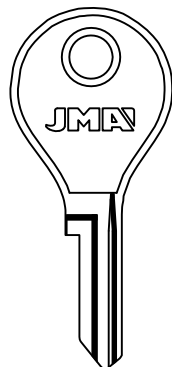
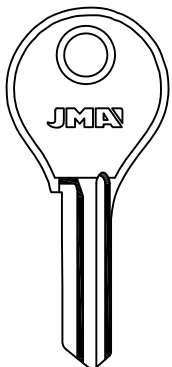

DOM-28 DOM-28D

6E...1-205
 DOM-29

EA0

8.4 2.4
DOM-30

MOREAUX

8.9 IX 5 2.35
DOM-31

CORBIN-EMHART



PARA-FOR:

DOM (D)

DOM

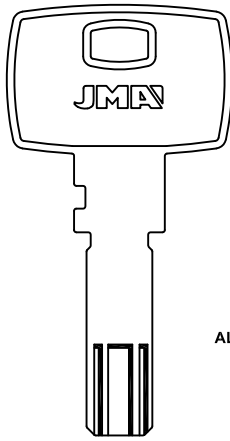

ALP.

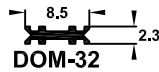

CORBIN-EMHART

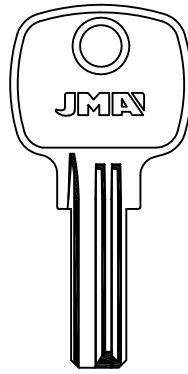

ALP.

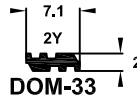

DOM-33

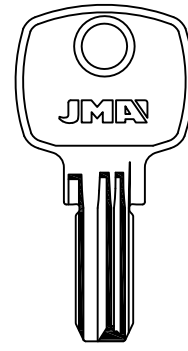

ALP.



DOM-34

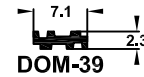

DOM-39

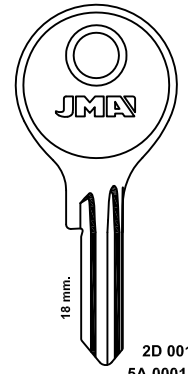

18 mm.

2D 001-222
5A 0001-2600
9A 0001-5200
1D 601-654



DOM-35



DOM-35D



DOM-51

DOM

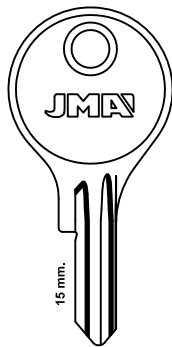

15 mm.

2D 001-222
5A 0001-2600
9A 0001-5200
1D 601-654



DOM-36



DOM-36D

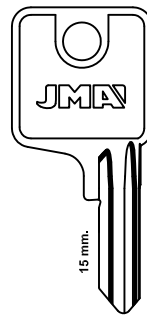

15 mm.

2D 001-222
5A 0001-2600
9A 0001-5200
1D 601-654



DOM-37



DOM-37D

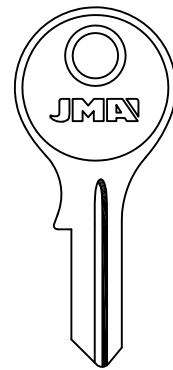

DOM-38D

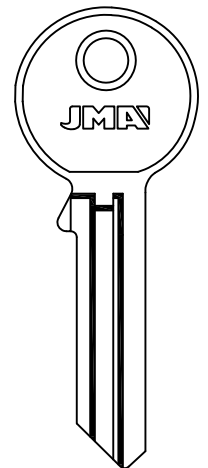

DOM-40D

DOM

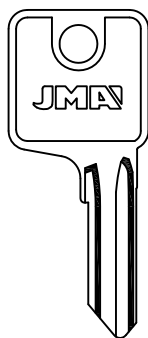

DOM-42
FLAMBO-HEKNA-NOBO
PEROHAUS

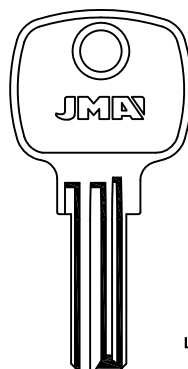

LAT.



DOM-43

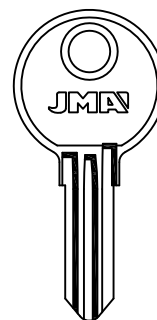

DOM-52

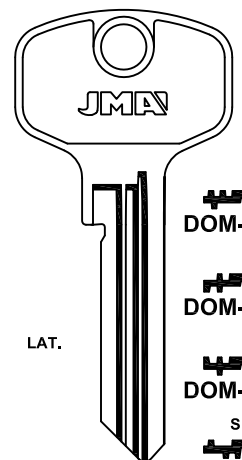

LAT.



DOM-74D



DOM-72D



DOM-58D



DOM-54D

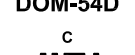

DOM-53D



DOM

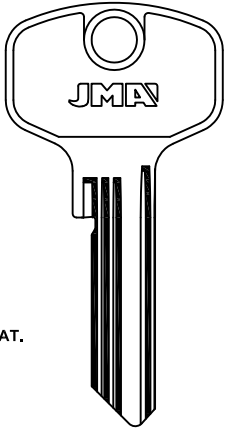

DOM-73D

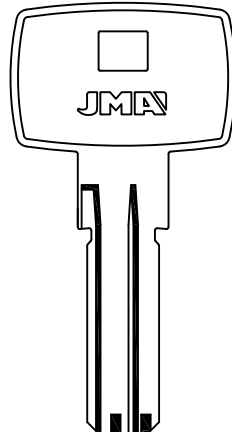

DOM-71D

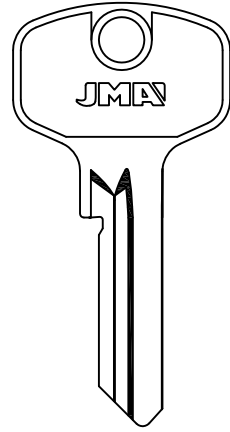

DOM-65

DOM-67D

DOM-61

DOM-60D

DOM-59

D
DOM-57

D
DOM-57D

S
DOM-55

S
DOM-55D

DOM-56D

DOM-63D

DOM-62D

STUV

LAT.

ALP.

PARA-FOR:

- DOM (D)
- DOMINION LOCK (USA)
- DOMUS (I)

DOM

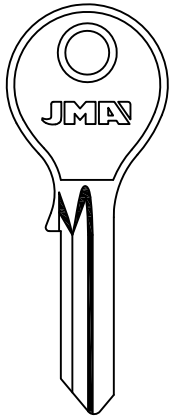

DOM-64D

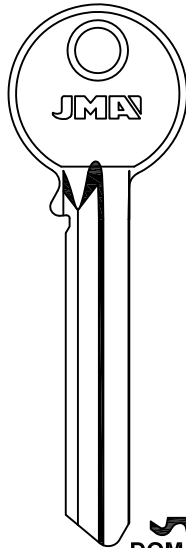

DOM-66D

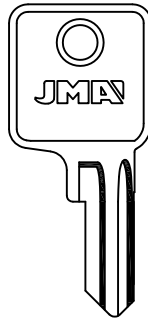

CL...1-250
GP...1-250
C...1001-1200
C...1301-1500
DOM-68

GEWIRU

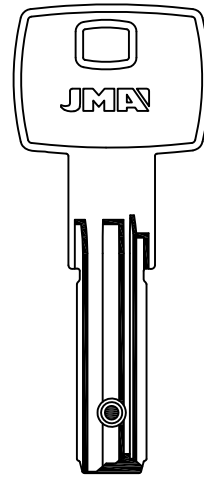

9
2,5
DOM-B1

CORBIN-ST5

ALP.

DOMINION LOCK

DOMUS

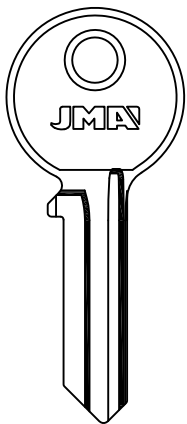

DOI-1

PETERBORO

LAT.

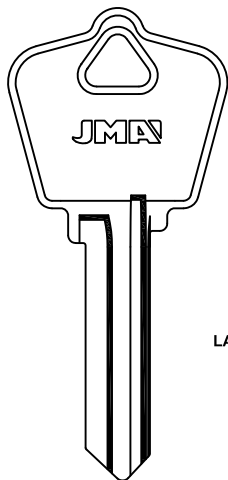

DOI-4

LAT.

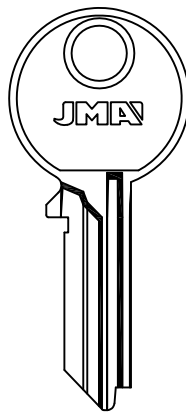

DO-21

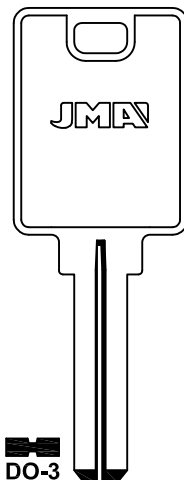

DO-3











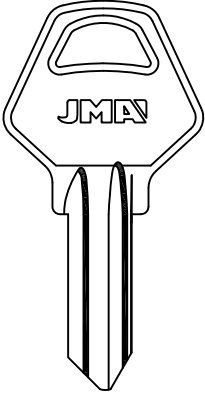
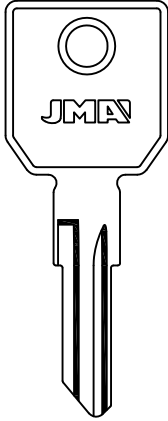
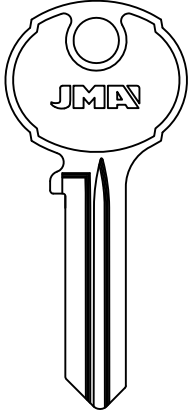
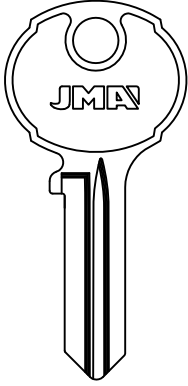



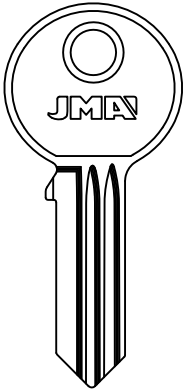
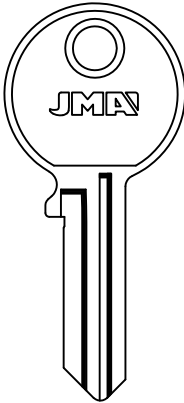
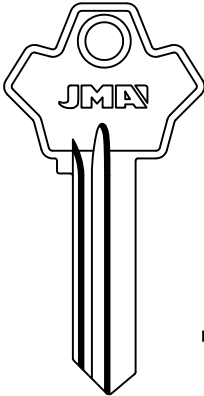
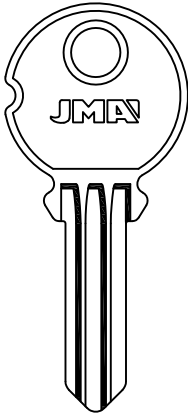

7
2,2
DO-4

ALP.

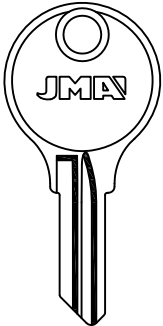
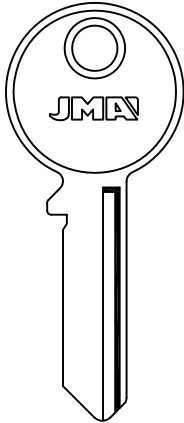
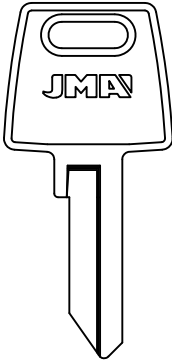
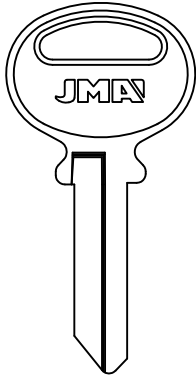

PARA-FOR:

- DOMUS (I)
- DOUBLE CIRCLE (RC)
- DURALOCK (USA)
- EAG (D)
- EAGLE (USA)
- ECM (I)
- EIKO (J)

DOMUS		DOUBLE CIRCLE	
			
 DO-5	 DO-5D	 DO-7	 DC-1D
			 DC-2D
		TRI CIRCLE	
DOUBLE CIRCLE		DURALOCK	EAG
			
 DC-3	 DC-4D	 DUR-1D	 EG-2
			 EG-1
		LAT.	
EAGLE	ECM	EIKO	
			
 EAG-2D	 EC-1	 EI-1D	 EI-2D
EZ... PZ... 1-240			CINA
LAT.			



ELZETT



ELZ-10

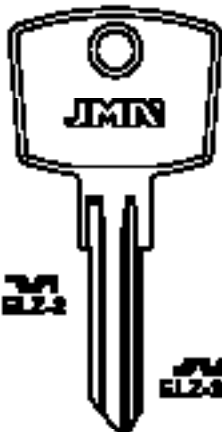

ELZ-4

ELZ-80

ELZ-40

ELZ-80



ELZ-80



ELZ-80

TIPENTAL-TUB

ELZETT



ELZ-4



LAT.

ELZ-10 ELZ-110



ELZ-110



ELZ-12

ELZ-120

EMKA



EMK-1

EP PINSON



EP-10

ERA



ER-10



ER-20

PARA-FOR:

ELZETT (H)

EMKA (F)











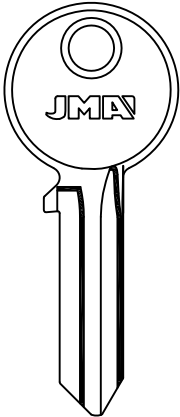
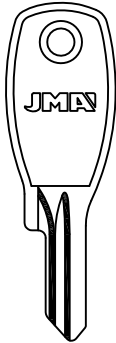
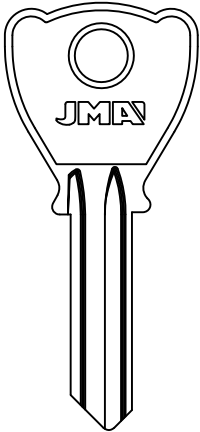
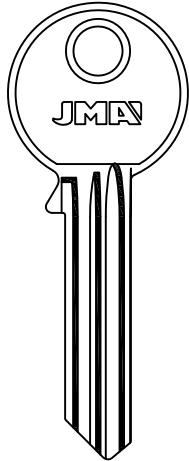





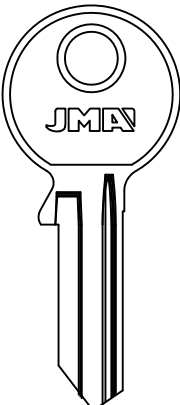
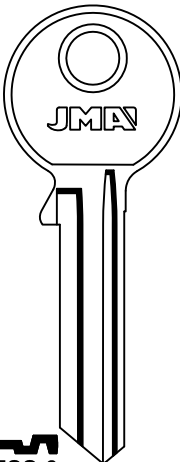
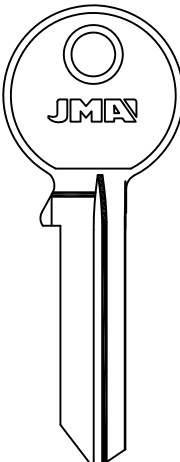
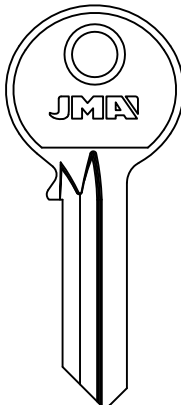



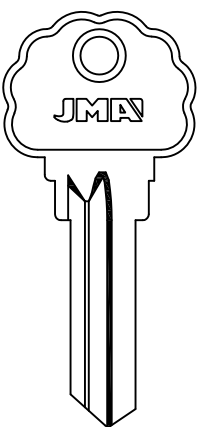
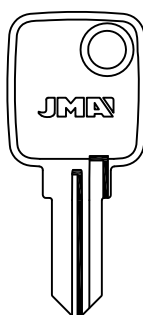
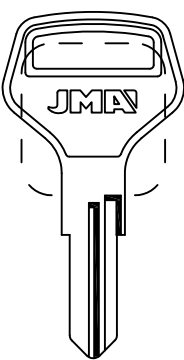
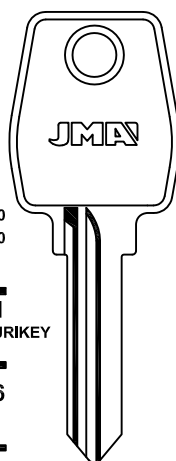

EP PINSON (GB)

ERA (GB)



PARA-FOR:

- ERA (GB)
- ESA (E)
- ESLA (GB)
- ESS (D)
- ETAS (GB)
- EUREKA (I)
- EURO BOX
- EURO LOCKS (B)

ERA		ESA	ESLA
	 LAT.		
 ER-3	 ER-4D	 ES-1I	 ES-1D
		NUMIDA	 ESL-1
			 ESL-1D
ESS			ETAS
		 LAT.	
 ESS-1	 ESS-3		
 ESS-2	 ESS-4	 E00	
		 ESS-9D	 ETS-1D
		BAB	YANEDIS
EUREKA	EURO BOX		EURO LOCKS
			
 EUR-1D	 EUB-1	 EUB-2	47001-48000 45000-47000 1201-1400  EU-1 EMKA-SECURIKEY
		BRABANTIA-MARS-WEDO	 EU-6
			 EU-9
			 EU-10D
			 EU-14D



EURO LOCKS

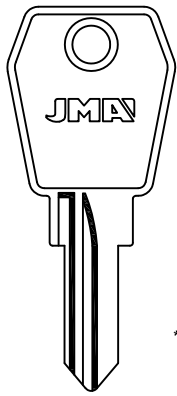

* ALU.



25001-27000



FASMA-L.&F.

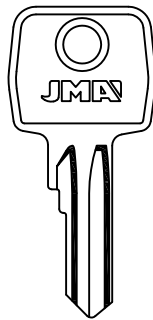
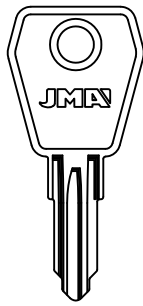

....
....A
458-5124



....
....E
405-4324

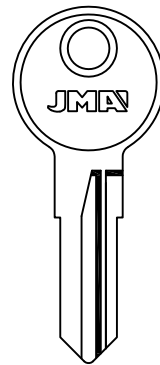

PARA-FOR:

EURO LOCKS

(B)

EVERGOOD (RC)

EVVA (A)

EURO LOCKS

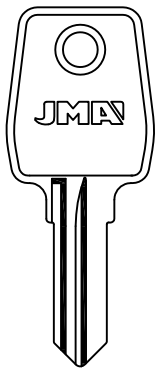

L&F

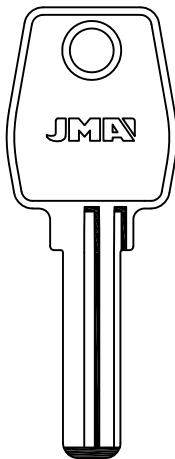

LAT.

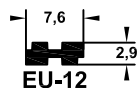

HOBBY-HYMER

EVERGOOD

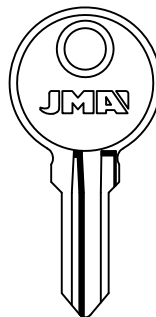

ARREGUI

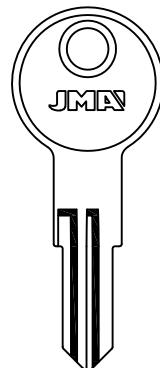

EVERGOOD

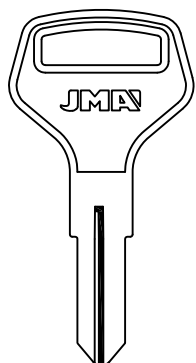

EVE-3D

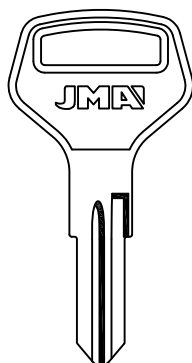

EVE-4

EVVA

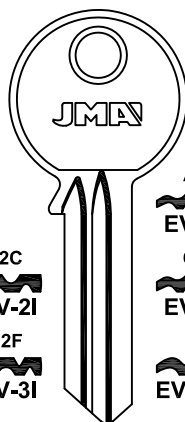

* LAT.



EV-2I



EV-3I



EV-1



EV-2



EV-3D



EV-13D



* EV-25D

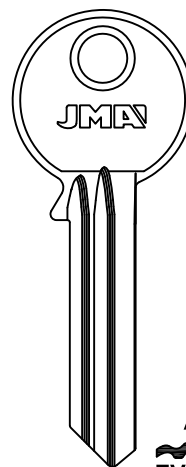

EV-4D



EV-10

ELCA

JMA[®]



Copyright by Alejandro Altuna S.A. 2014

ATENCIÓN: Concerniente a las marcas y denominaciones comerciales ver nota en índice.
ATTENTION: Concerning the marks and commercial denominations see note in index.
ATTENTION: Concernant les marques et dénominations commerciales voir la note dans l'index.
ACHTUNG: Beziehen auf die marke und handelsname sehen sie die notiz im index.

PARA-FOR:

- EVVA (A)
- EXCEL (F)
- EXPRES (PL)
- EZCURRA (E)

EVVA

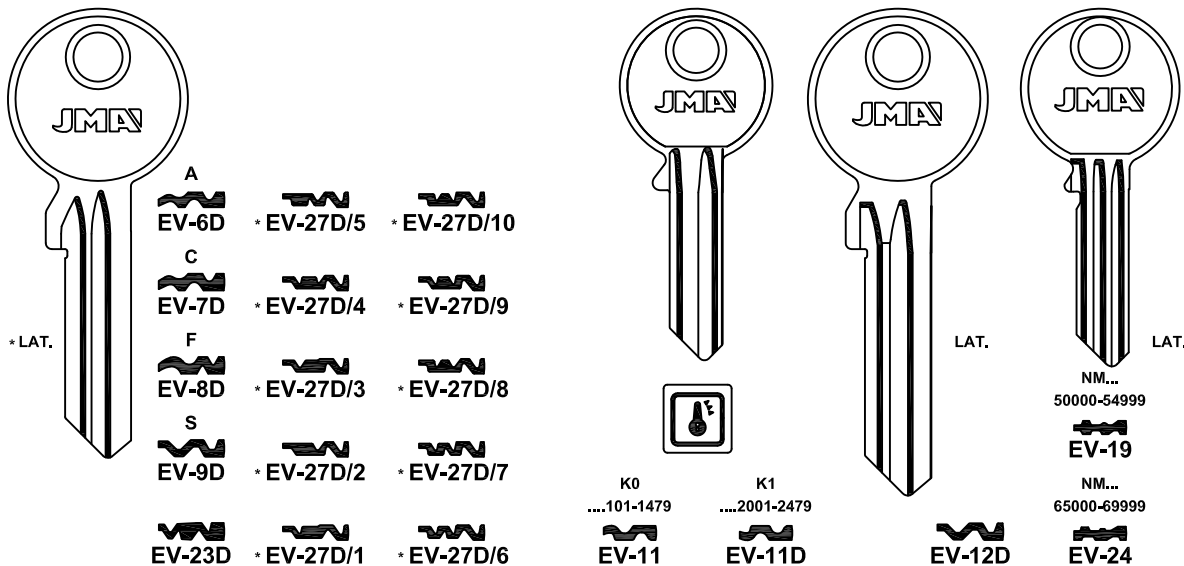

A
 EV-6D *EV-27D/5 *EV-27D/10
 C
 EV-7D *EV-27D/4 *EV-27D/9
 F
 EV-8D *EV-27D/3 *EV-27D/8
 S
 EV-9D *EV-27D/2 *EV-27D/7
 EV-23D *EV-27D/1 *EV-27D/6

K0
101-1479
 EV-11

K1
2001-2479
 EV-11D

NM...
 50000-54999
 EV-19
 NM...
 65000-69999
 EV-24

EV-12D EV-24

ELCA-TRYBA

EVVA

EXCEL

EXPRES

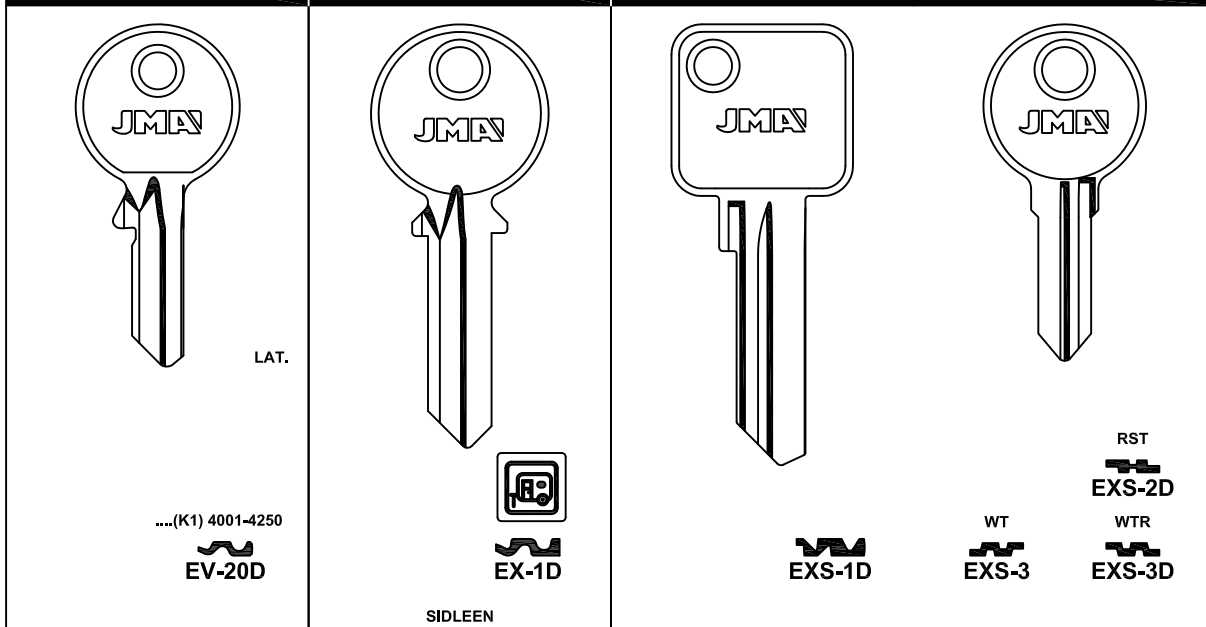

....(K1) 4001-4250
 EV-20D

SIDLEEN
 EX-1D

EXS-1D

WT
 EXS-3

RST
 EXS-2D
 WTR
 EXS-3D

EXPRES

EZCURRA

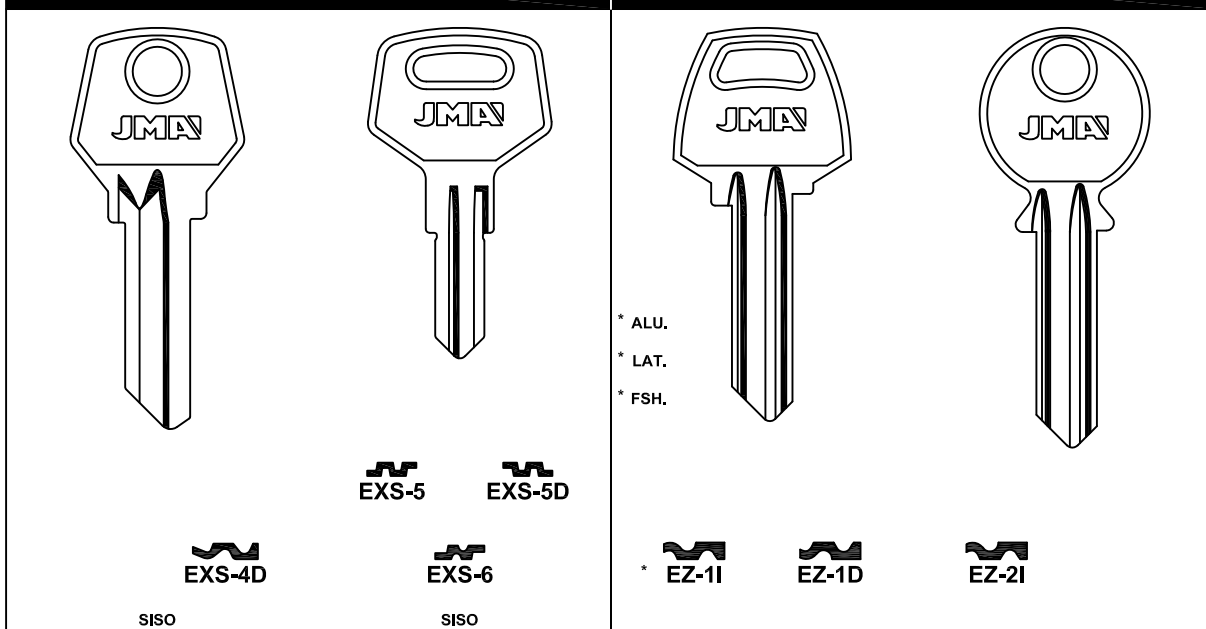

EXS-4D
 SISO

EXS-5 EXS-5D
 EXS-6
 SISO

* ALU.
 * LAT.
 * FSH.

* EZ-11 EZ-1D EZ-21



EZCURRA

PARA-FOR:

EZCURRA (E)

FAB (CZ)

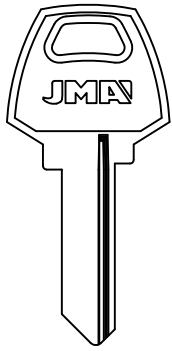

EZ-3I

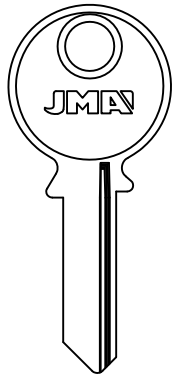

EZ-3D

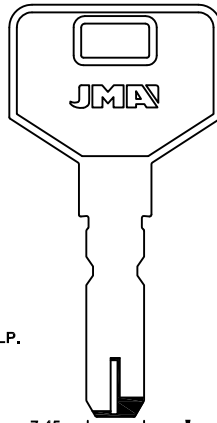

EZ-DS10
CAS

EZ-DS10E

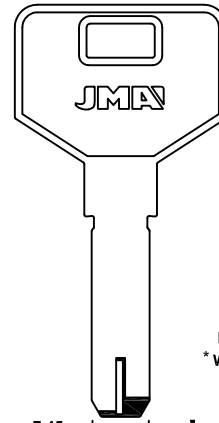

EZ-DS15

* EZ-DS15R

ALP.

LAT.
* WNC.

FAB

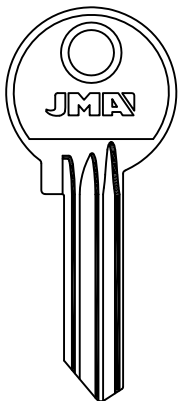

11
FB-1



8
FB-3



9
FB-19



10
FB-20



12
FB-21



13
FB-22



14
FB-23



15
FB-24



16
FB-25



FB-31

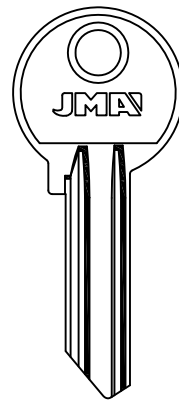

22
FB-21



FB-2D



10X
FB-4



11X
FB-5



20
FB-6



21
FB-7



23
FB-8



24
FB-9



26
FB-10



30
FB-11



32
FB-12



12X
FB-26



14X
FB-29

FAB

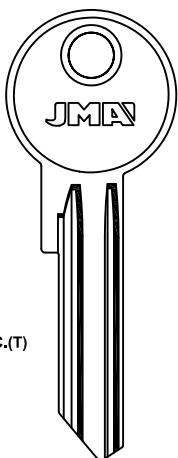

PR22
* FB-13



PR23
FB-14



PR24
FB-15



PR26
FB-16



PR30
* FB-17



PR32
FB-18



PR20
* FB-27



PR21
FB-28



10X
FB-32



12X
FB-34



11X
FB-35



K
FB-38

14X
FB-41

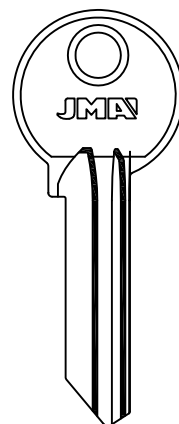

FB-33

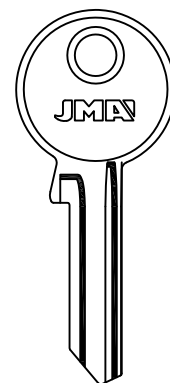

FB-39

* MTIC.(T)

JMA[®]

Copyright by Alejandro Altuna S.A. 2014



ATENCIÓN: Concerniente a las marcas y denominaciones comerciales ver nota en índice.
ATTENTION: Concerning the marks and commercial denominations see note in index.
ATTENTION: Concernant les marques et dénominations commerciales voir la note dans l'index.
ACHTUNG: Beziehen auf die marke und handelsname sehen sie die notiz im index.

PARA-FOR:

FAC (E)

FAC

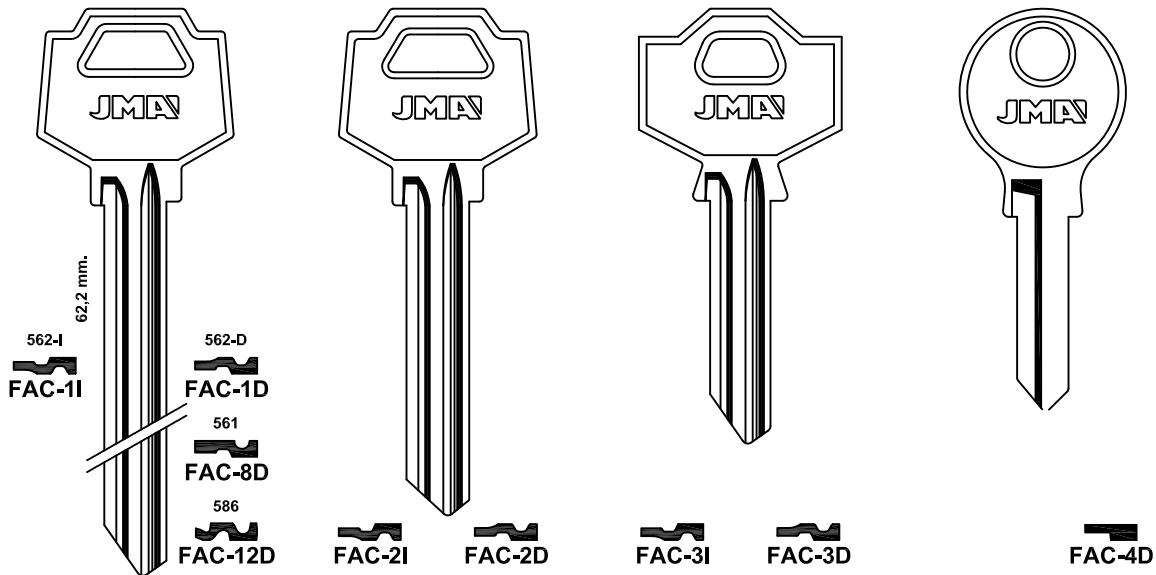

FAC

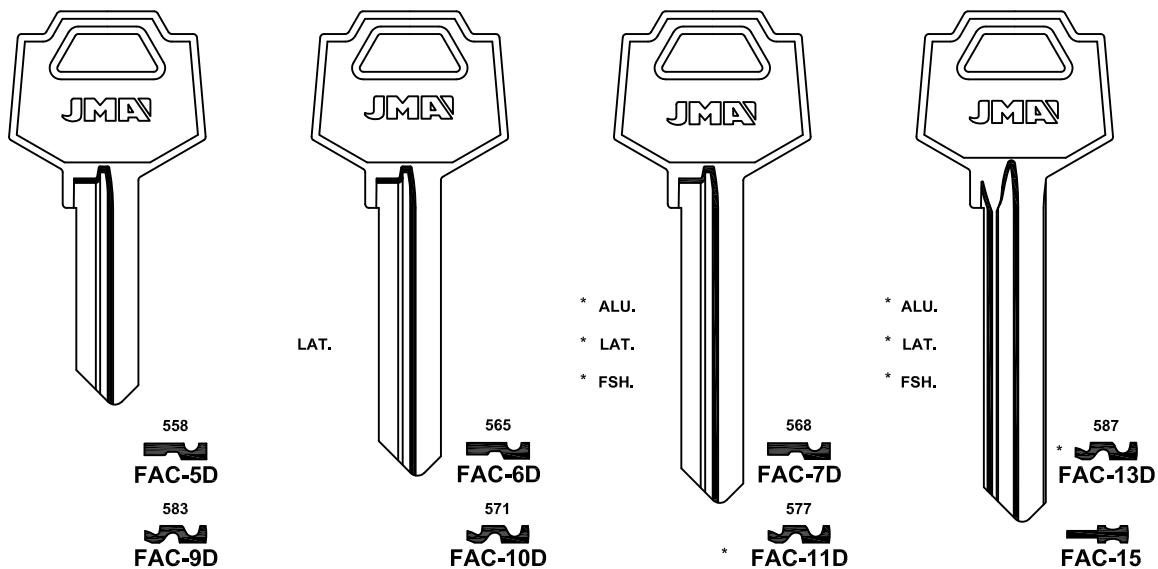

FAC

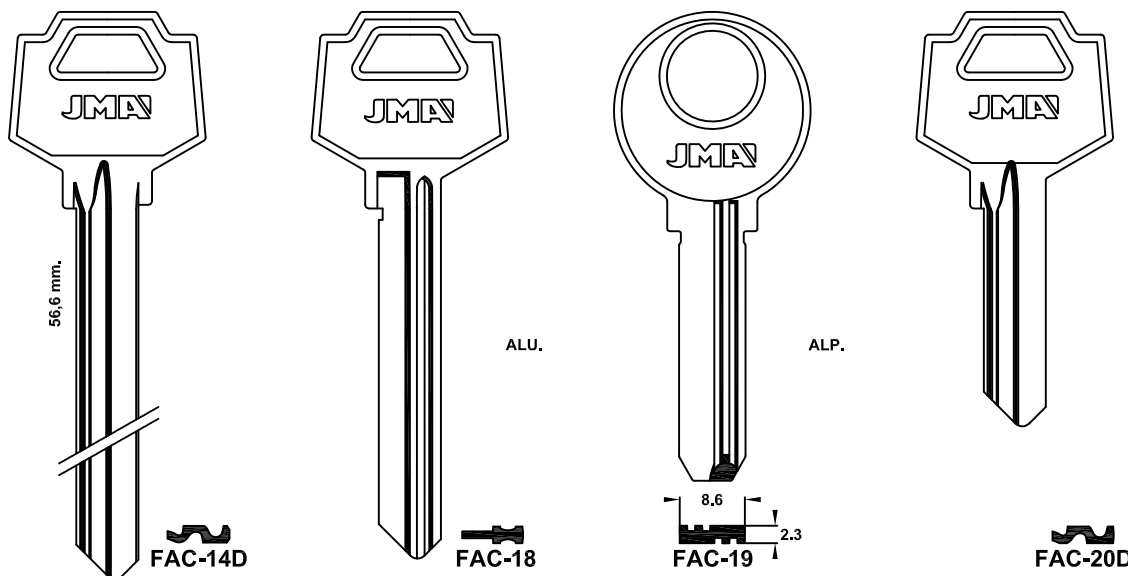

FAC

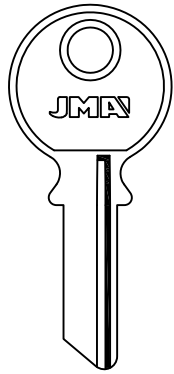

FAC-21

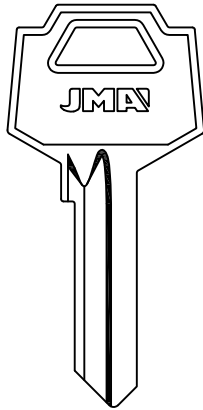

FAC-21D

FAC-22D

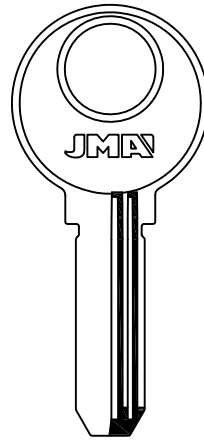

LAT.

FAC-23
8.9 2.35

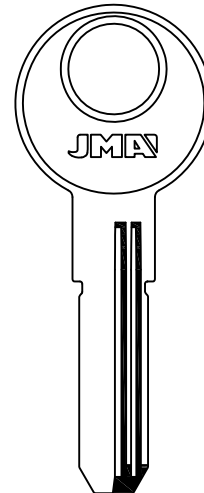

LAT.

FAC-24
8.9 2.35

PARA-FOR:

- FAC (E)
- FAINER (P)
- FALCON (USA)
- FAMA (BR)
- FANA (D)
- FAS (S)
- FASEM (I)
- FAVOUR (DZ)

FAINER

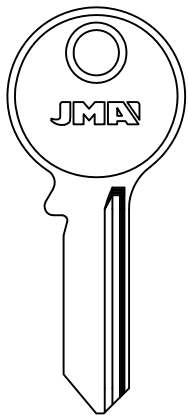

FAIN-1

SIL

FALCON

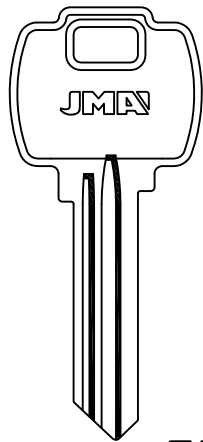

LAT.

FAL-1D

FAL-2D

WEISER

FAMA

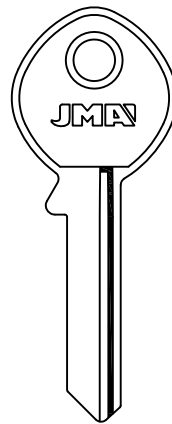

FAM-1

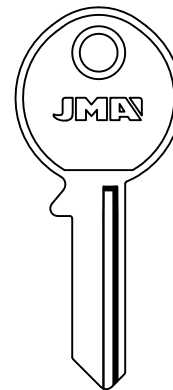

FAM-2

FANA

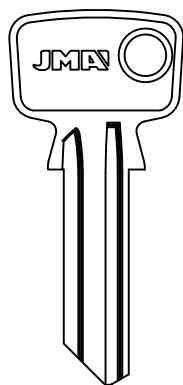

FAN-1

FAN-1D

FAS

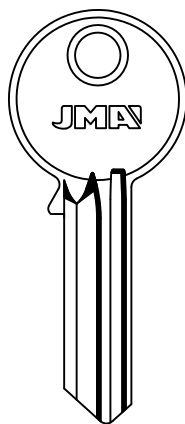

FA-1

FA-1D

FASEM

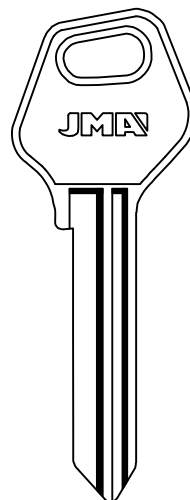

FAS-1

FAVOUR

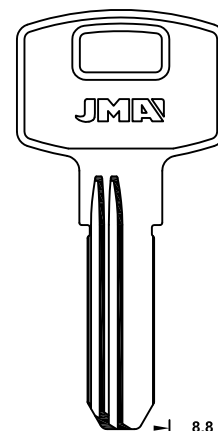

LAT.

FAV-1D
8,8 2,35

FAV-2

TEICOCIL



PARA-FOR:

FAYN (RC)











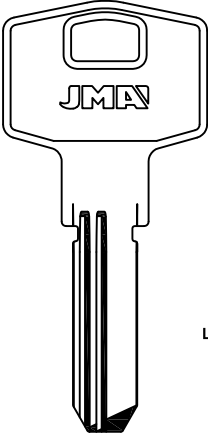
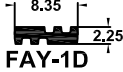
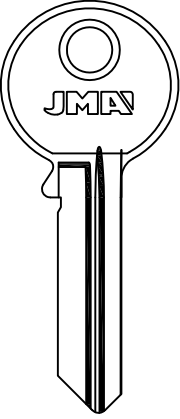

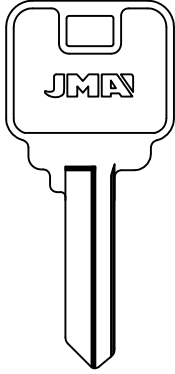

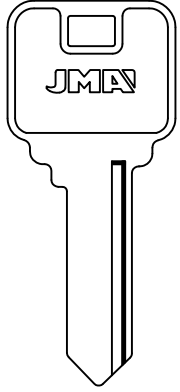

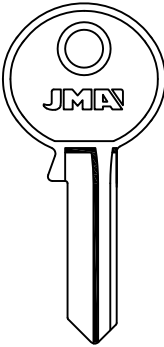

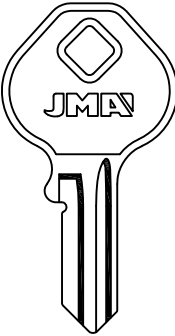

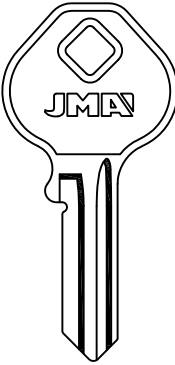

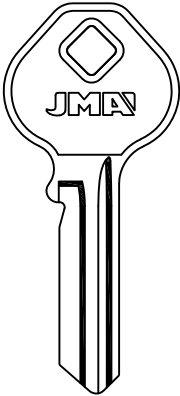

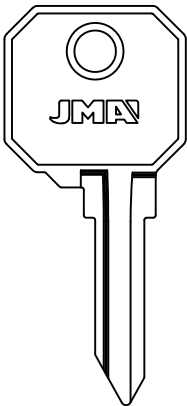

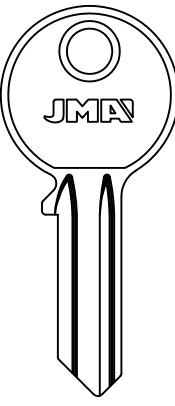
FCV (D)

FECHADURA
(BR)

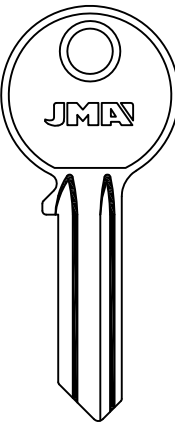
FEDERAL (USA)

FERONERIA
(RU)

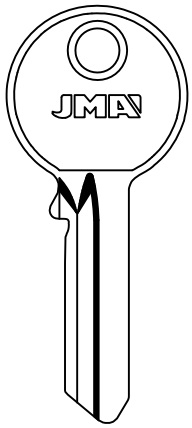
F.F. (I)

	FAYN	FCV	FECHADURA	
	 <p>LAT.</p>  <p>FAY-1D</p>	  <p>FV-1D</p>	  <p>FEC-1D</p>	  <p>FEC-2</p> <p>STAM</p>
	FECHADURA	FEDERAL		
	  <p>FEC-3D</p> <p>STAM</p>	  <p>FED-1</p>	  <p>FED-2</p>	  <p>FED-3</p>
	FERONERIA	F.F.		
	  <p>FER-1</p>	 <p>0 AL 7</p>  <p>FF-1</p>  <p>FF-1D</p>  <p>FF-3</p> <p>GUARDIAN</p>	 <p>0 AL 7</p>  <p>FF-2</p>  <p>FF-2D</p>  <p>FF-10D</p> <p>GUARDIAN</p>	  <p>FF-5D</p>



F.F.

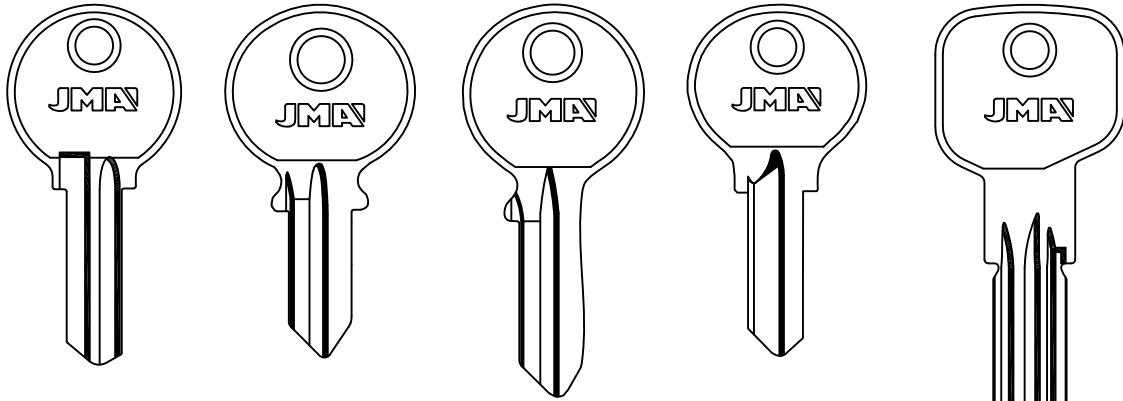

FF-6



FF-11



FF-7D



FF-8D



FF-9D



FF-13

LAT.

PARA-FOR:

F.F. (I)

FIC LOCKS
(USA)

FICHET (F)

FIC LOCKS

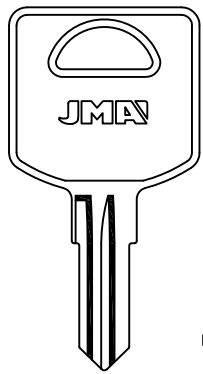

LAT.



FCS-1D

FICHET

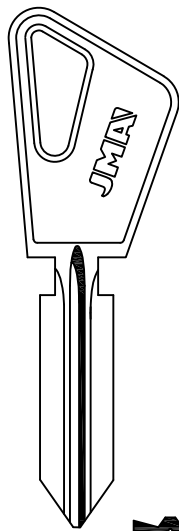

LAT.



FIC-1



FIC-2

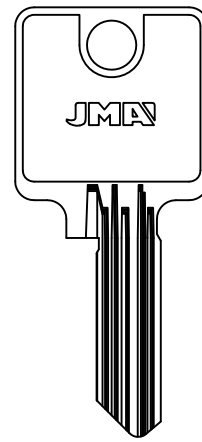
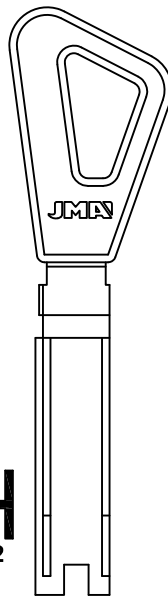

FIC-5

SURFINOR

FICHET

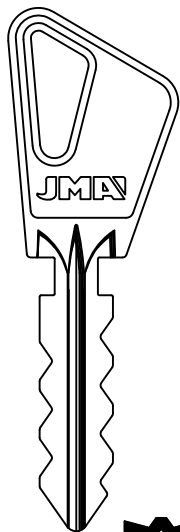

FIC-7

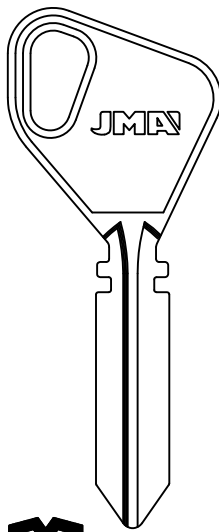

FIC-8

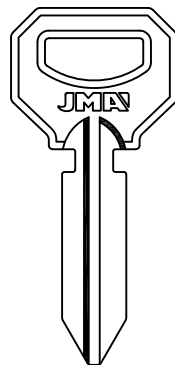

FIC-9

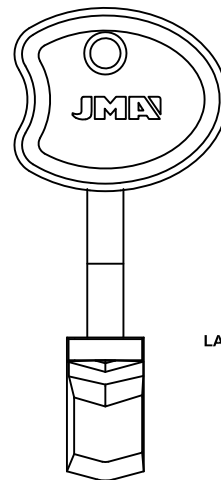

FIC-18

LAT.











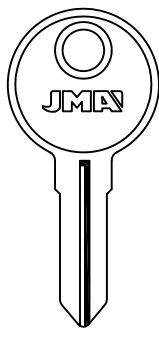

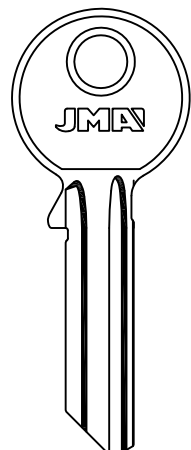

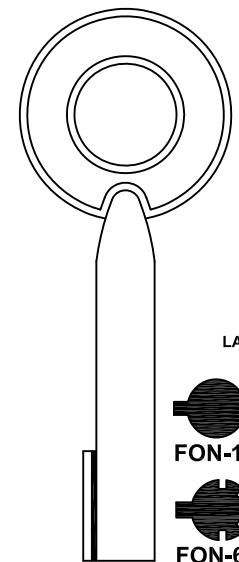

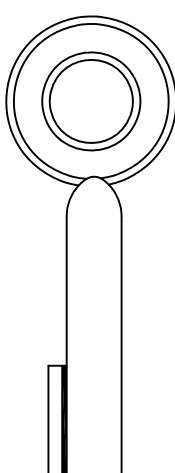

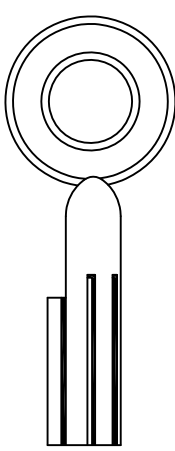

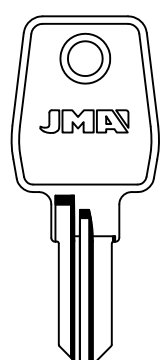

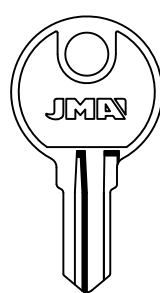
SURFINOR

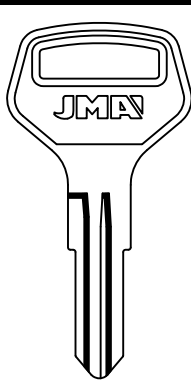
TECNOR

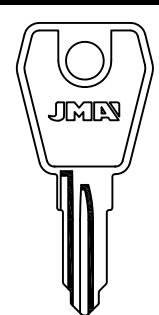

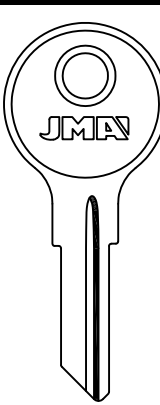
PARA-FOR:

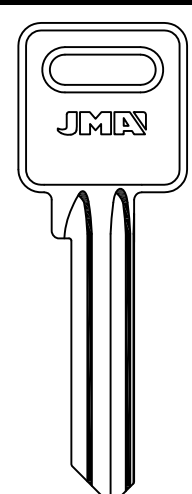
- FIST (I)
- FLORA (D)
- FONTAINE (F)
- FORT (F)
- FORTE (YV)

FIST	FLORA	FONTAINE	
  FIS-1D	   FLO-1 FLO-1D <small>FLOHR-NB-NORDWEST-SUKI</small>	   FON-1E FON-6E <small>LAT.</small>	
FONTAINE		FORT	
   FON-2E FON-5E	   FON-4E FON-3E <small>PROGRES</small>	  FR-1D <small>DAD</small>	   FR-2 FR-4
FORT			FORTE
  FR-7D <small>501-600</small>  FR-8 <small>ARREGUI</small>	  FR-9D <small>FG</small> <small>ABUS-SECURITAL</small>	  FR-11D	   FTE-1 FTE-1D

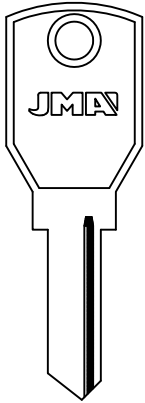
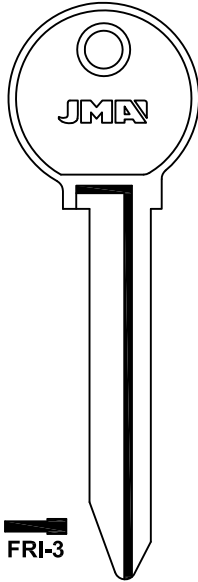
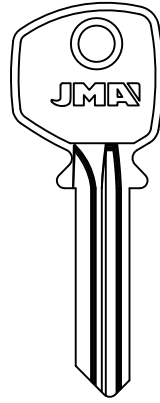
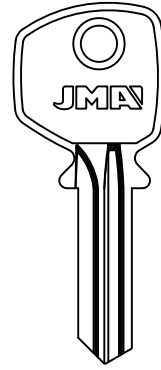

FORTIS
FORTIS-21**FRIPA**
FRI-3**FTH**
FTH-1
FTH-8
FTH-1D
FTH-8D
FTH-2**PARA-FOR:**

FORTIS (E)

FRIPA (D)

FTH (F)

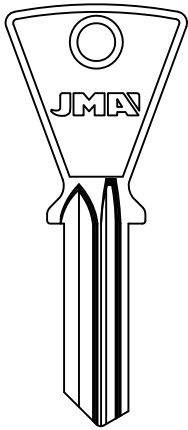
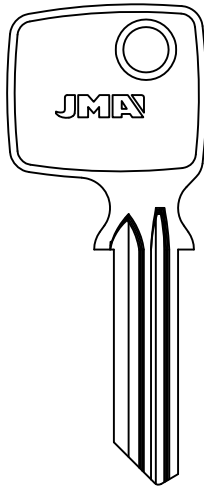
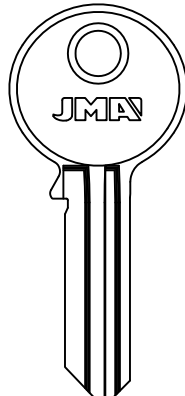
FTH
FTH-3
FTH-4.....A 1 AL 9

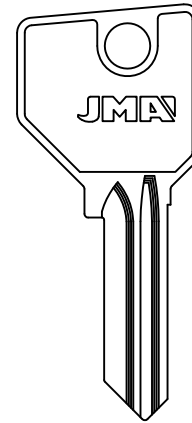
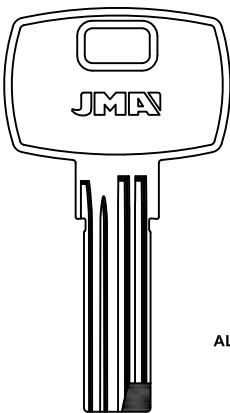
FTH-5
FTH-22
FTH-6**FTH**

ALP.

FTH-7

CODEM-TOVER-YALTRES

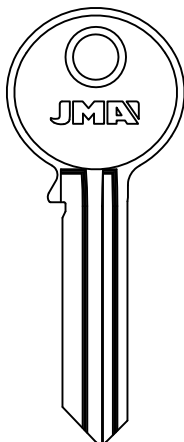
.....A 1 AL 9

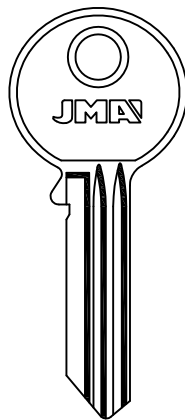
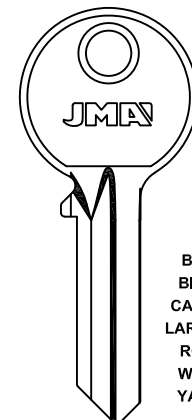
FTH-9
FTH-10
FTH-21CF-CIB-4FAM-JL-NICO-PROBAT
CIBC-CITY-SUFBKS
BIRD
CARAT
LAREDO
ROC
WOC
YALE.....0 AL 9

FTH-11D

PARA-FOR:

FTH (F)

FTH

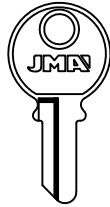

FTH-12D

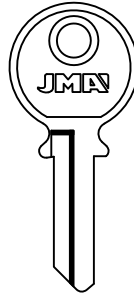

FTH-13D

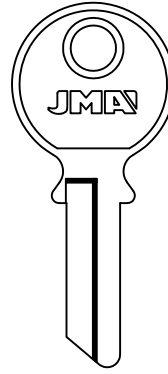

FTH-14D

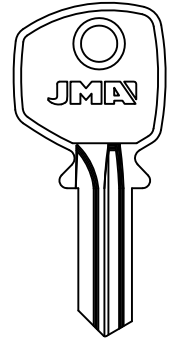

FTH-15

FTH

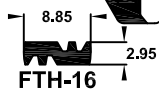
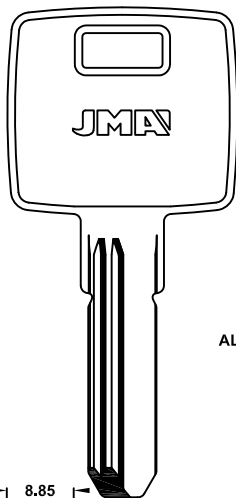

IFAM-KARO

ALP.

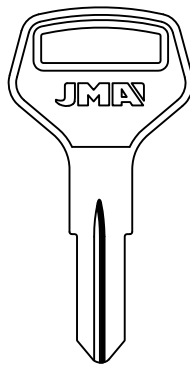

FTH-17D

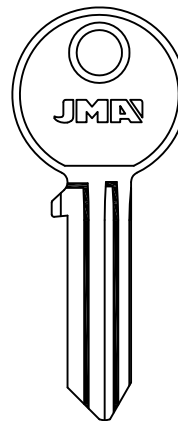

.....A 1 AL 9
FTH-18

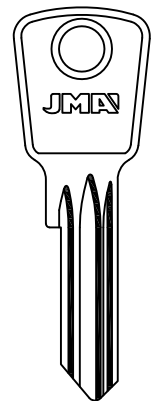

FTH-19

FEDERAL

FTH

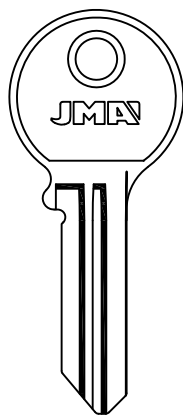

FTH-20D

HERACLES

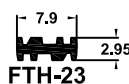
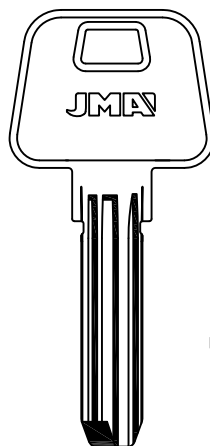

FTH-23

ATLANTIC

LAT.

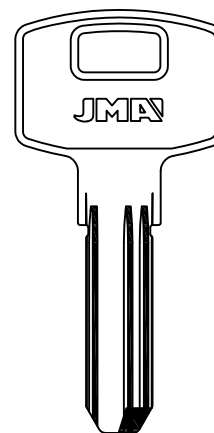

FTH-25

LAT.

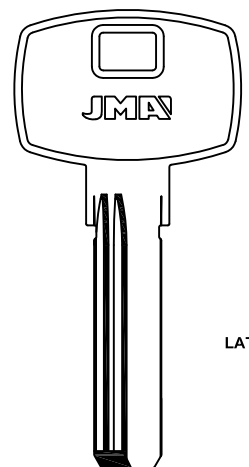

FTH-26D

SP

LAT.



FTH

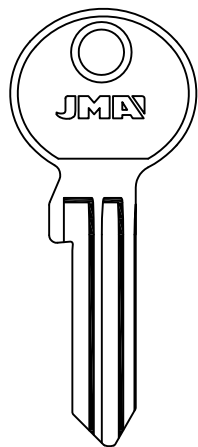

FTH-27

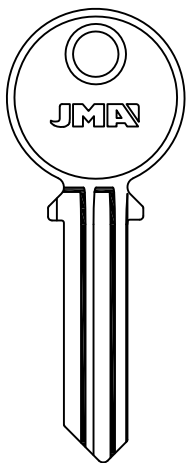

FTH-28

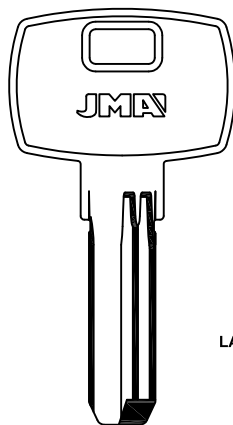

FTH-29

LAT.

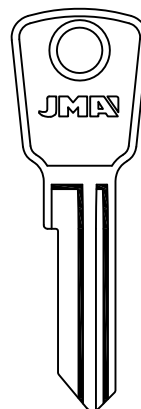

FTH-31

FEDERAL

PARA-FOR:

- FTH (F)
- GABON (F)
- GAMMET (PL)
- GATO (COL)
- GBZ (I)
- GE GE (A)

GABON

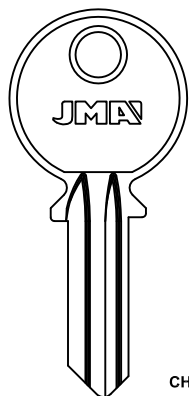

GAB-1I

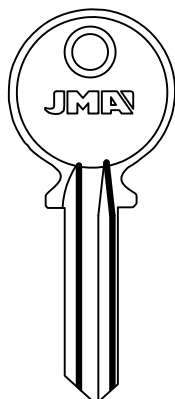

GAB-1D

CHG
GALLUS
MAXIGARD
PICARDIE
SOS
WINNER

GAB-2
CHG-GALLUS-MAXIGARD
PICARDIE-SOS-WINNER

GAMMET

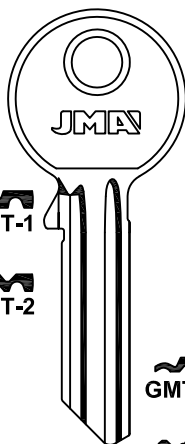

GMT-1

GMT-2

GMT-3D

GMT-4D

GMT-5D

EXPRES

GATO

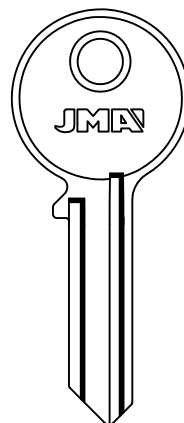

GAT-1

GATO

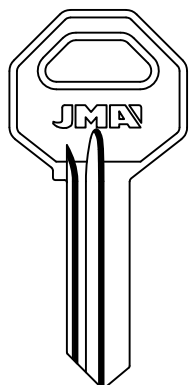

GAT-2D

LAT.

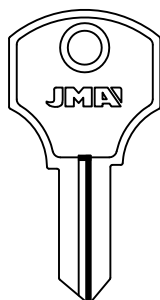

GAT-3D

LAT.

GBZ

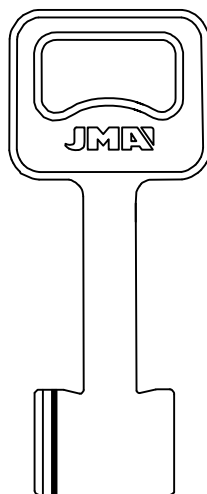

GBZ-1

LAT.

GE GE

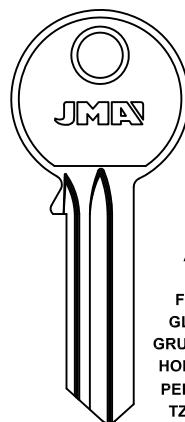

GE-2

ABUS
FLIK
FULLEX
GLOSTAL
GRUNDMANN
HOHRMANN
PEROHAUS
TZAFRER

GE-1D



PARA-FOR:

GE GE (A)

GEBA (D)

GERA (D)

GE GE

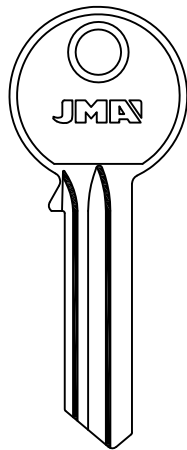

1.....
500001-735807



ALFA-FINSTRAL

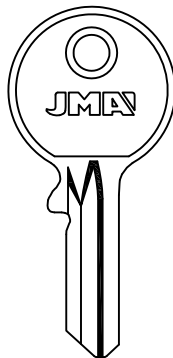

X....1001-1875
E...00-576



LABOFA-PEROHAUS

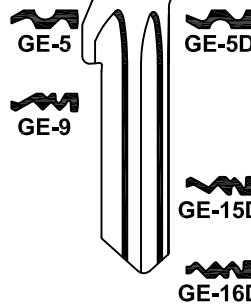
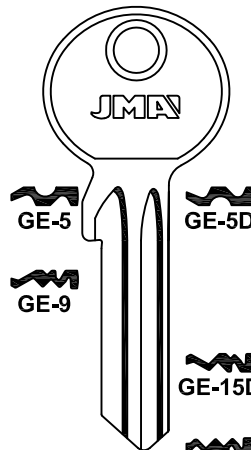

PEROHAUS

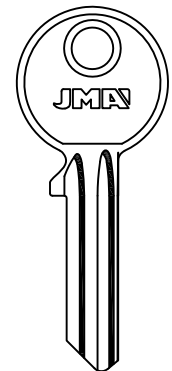

PEROHAUS



PEROHAUS

GE GE

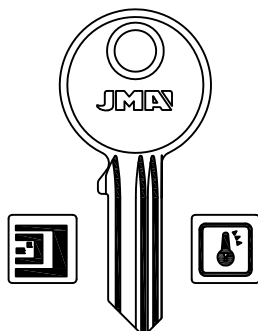

M35 Z....
20655-21806



M25 Z....
9135-10286



GEBA

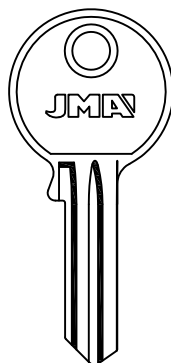

GEBA

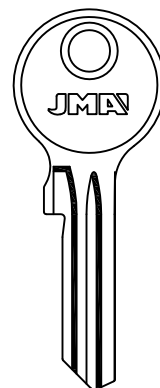

GERA

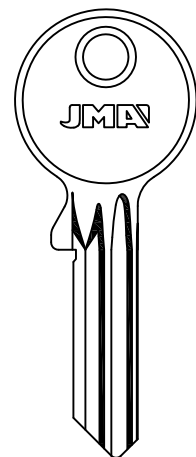

GERA



GERA

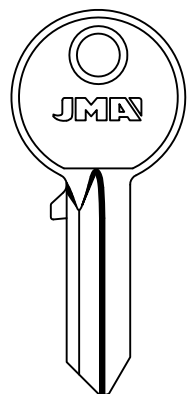

GERA

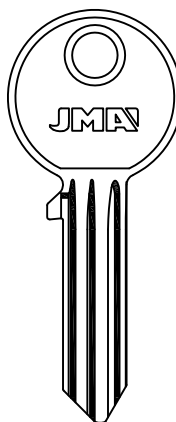

GERA

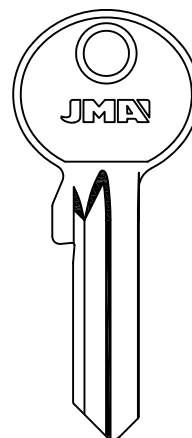

GERA

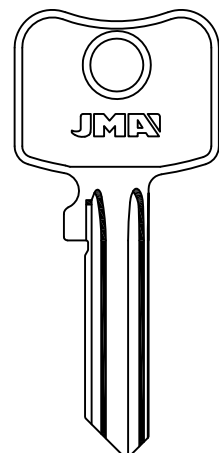

GERA



GERA

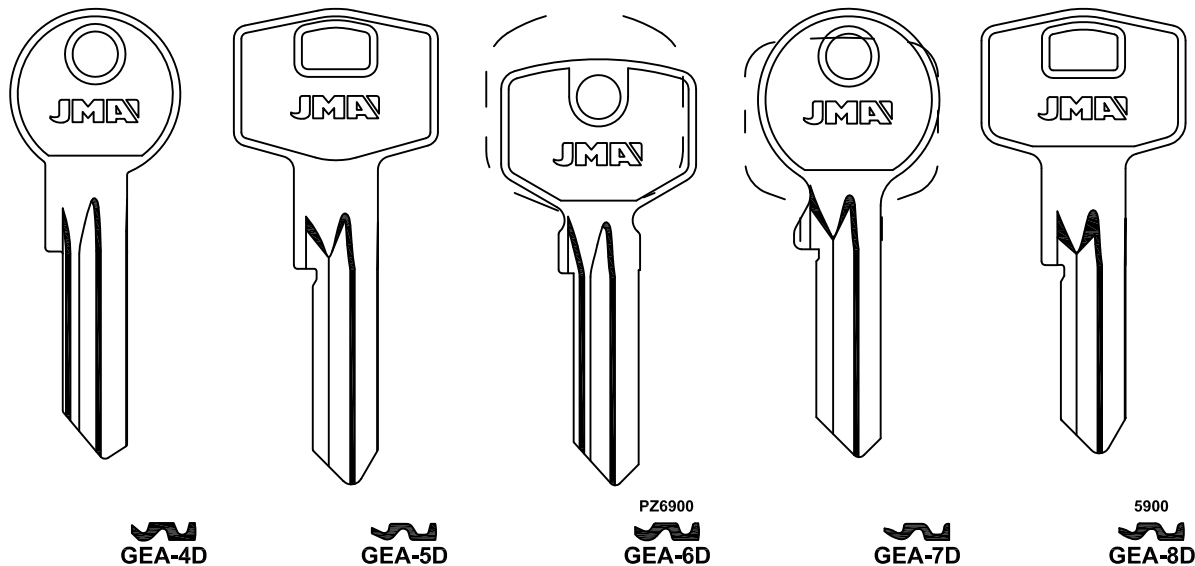

ROTO

PARA-FOR:

GERA (D)
GERDA (PL)
GIBBONS (GB)
GIUSSANI (I)

GERDA

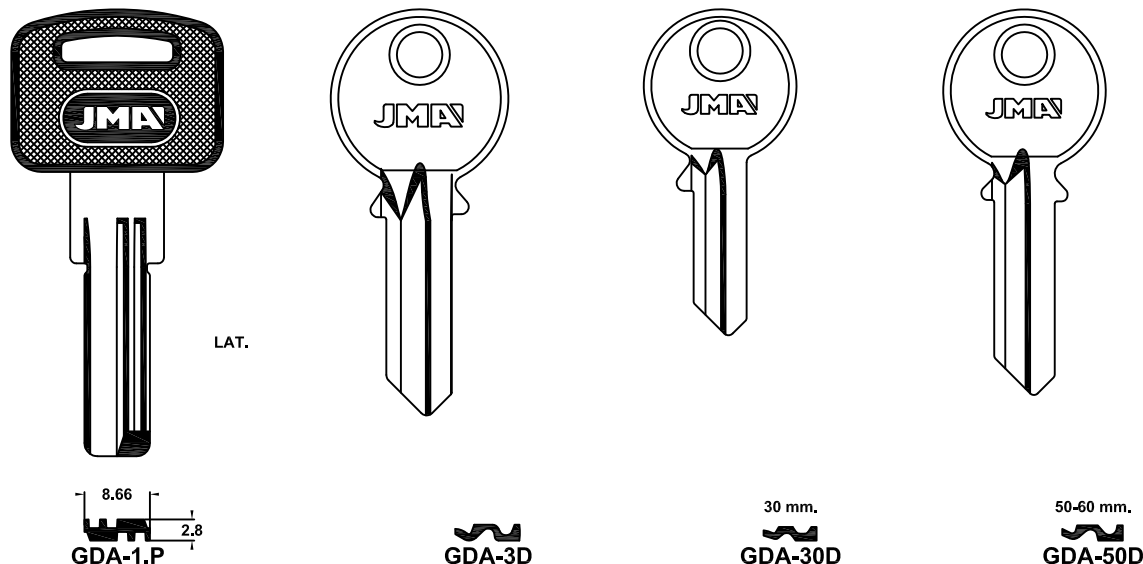

EUROPROFIL

EUROPROFIL

GERDA

GIBBONS

GIUSSANI

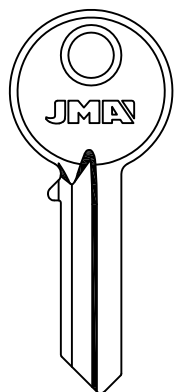

GDA-60D

EUROPROFIL

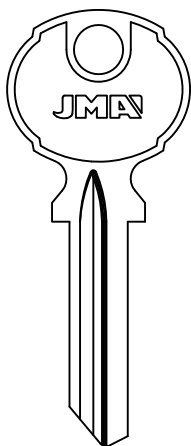

GIB-1D

WILLENHALL

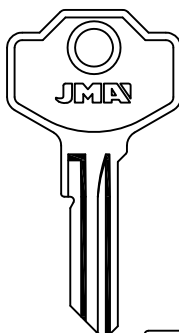

9001-9741
3001-3480

GIU-1

3001-3480

GIU-2

SIMECA



GIU-1D

GIU-2D

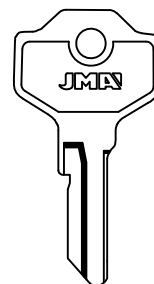

GIU-3D

OAL-LUME

JMA[®]







Copyright by Alejandro Altuna S.A. 2014



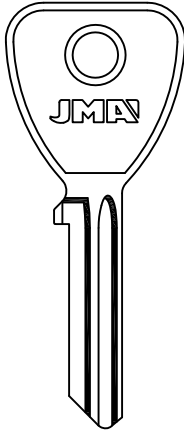
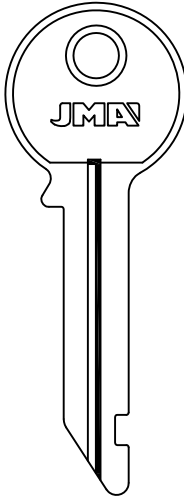
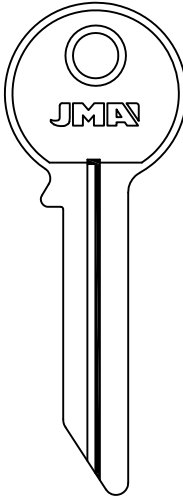
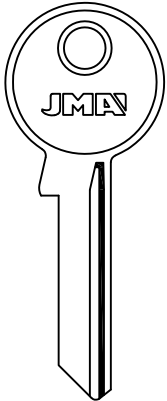





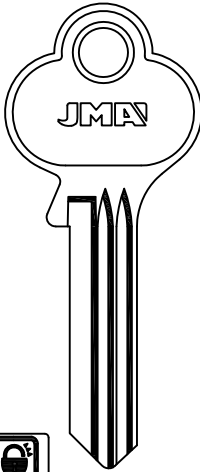
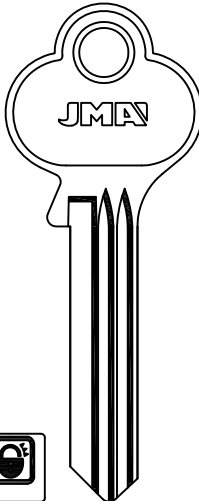
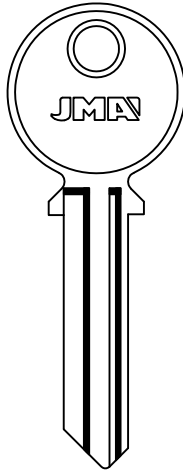
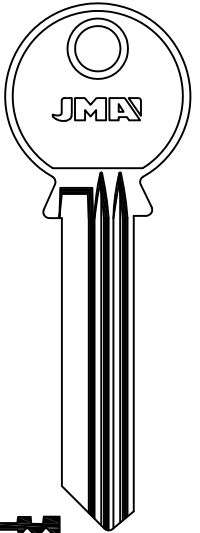

ATENCIÓN: Concerniente a las marcas y denominaciones comerciales ver nota en índice.
ATTENTION: Concerning the marks and commercial denominations see note in index.
ATTENTION: Concernant les marques et dénominations commerciales voir la note dans l'index.
ACHTUNG: Beziehen auf die marke und handelsname sehen sie die notiz im index.

PARA-FOR:







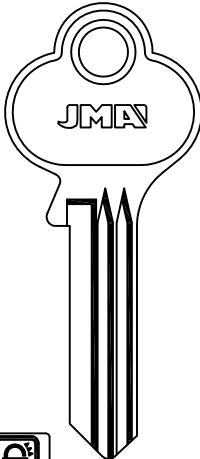
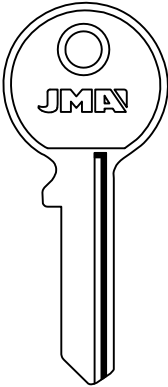
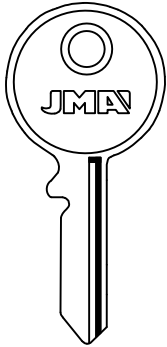
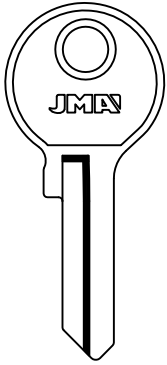

- GIUSSANI (I)
- GLAZIEV (RUS)
- GLOBE (RC)

GIUSSANI	GLAZIEV		GLOBE
			
			 

GLOBE

			
 	 	 	
LARK		MIAN-FORCE	

GLOBE

			
 	 	 	
GOLD DOOR			



GLOBE

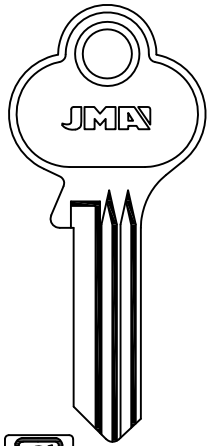

GLO-10

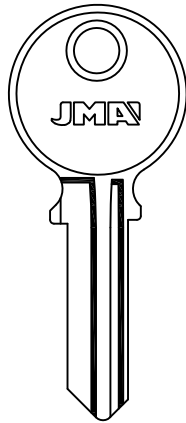

GLO-11

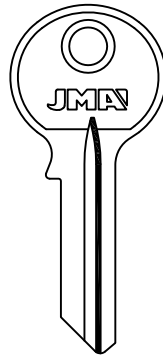

GLO-12D

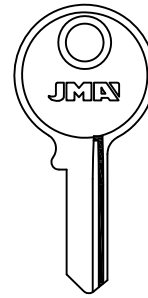

GLO-22 GLO-22D

GOLD DOOR

PARA-FOR:

- GLOBE (RC)
- GODREJ (IND)
- GR (RC)
- GTV (D)
- GUARD (HK)

GLOBE

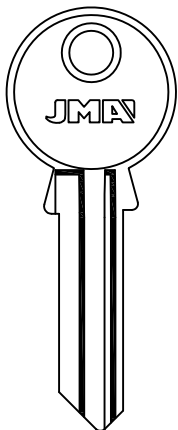

GLO-23 GLO-23D

ANLO-LUCO

GODREJ

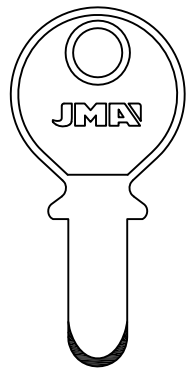

ALP.

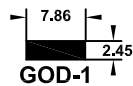

GOD-1

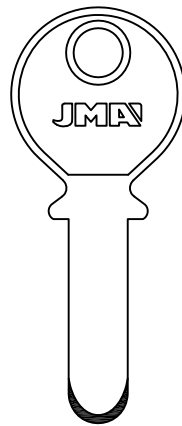

ALP.

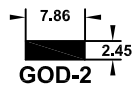

GOD-2

GR

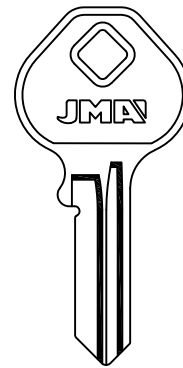

GRG-1

GTV

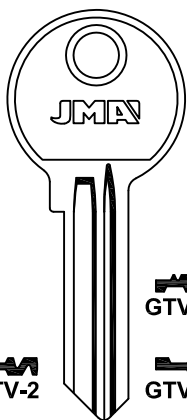

GTV-1D

GTV-2

GTV-2D

GTV-3D

GTV-4D

TIEFENTHAL

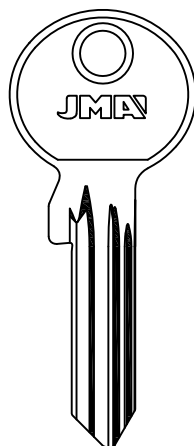

GTV-5D

JOWIL-TIEFENTHAL

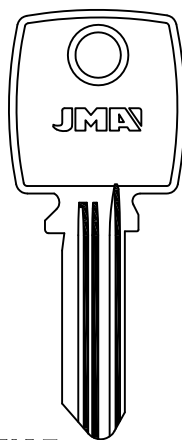

GTV-11

GTV-10

TIEFENTHAL

LAT.

GUARD

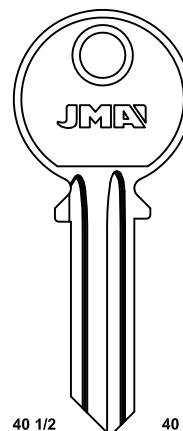

40 1/2
GUA-1

41 1/2
GUA-2

40
GUA-1D











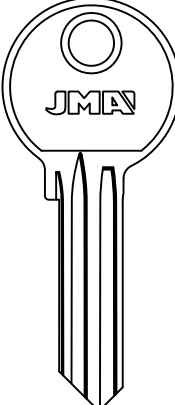
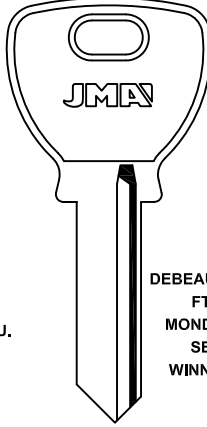
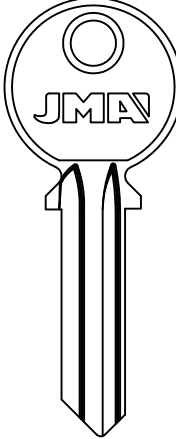
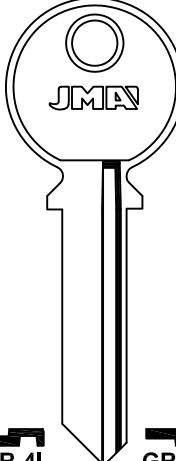









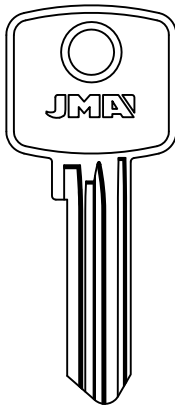
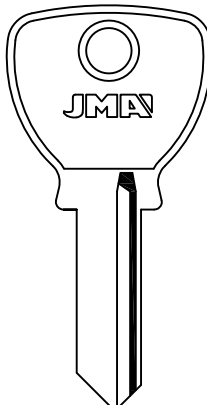
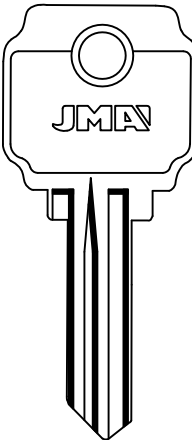
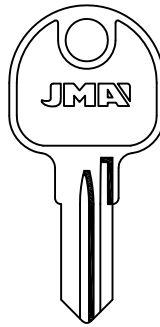



41
GUA-2D

FAB

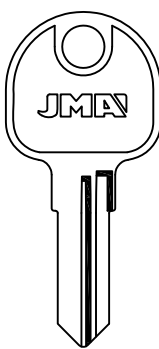
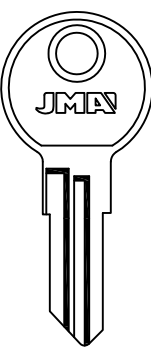
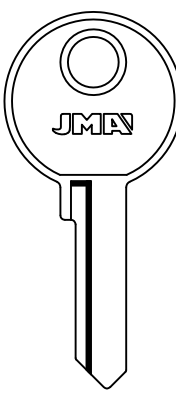
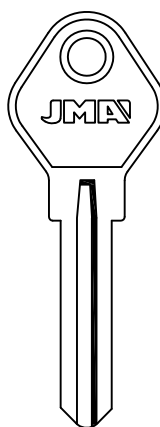







PARA-FOR:

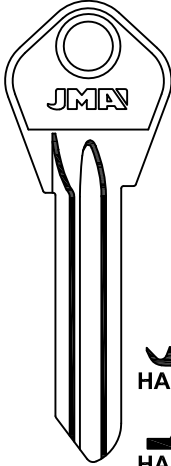
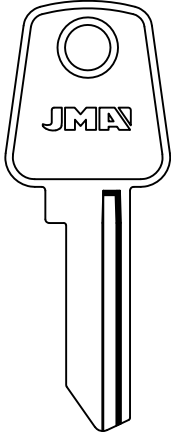
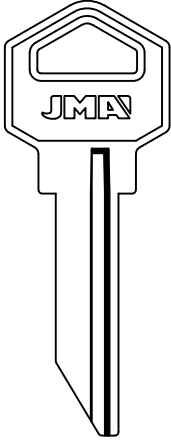
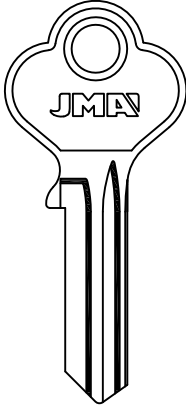







- GUARD (HK)
- GUERVILLE R. (F)
- HÄFELE (D)
- HAGA (RC)
- HALLE (USA)

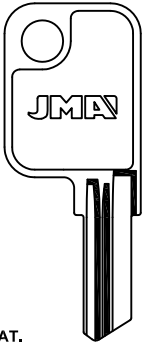
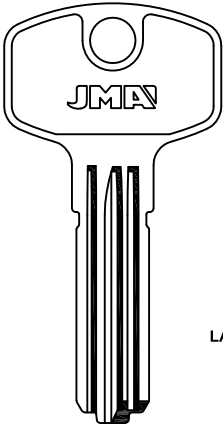
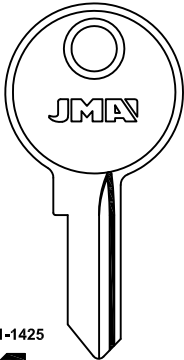
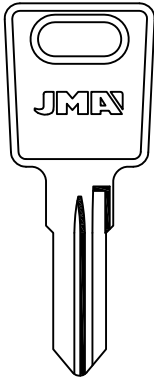



GUARD	GUERVILLE R.		
	 <p>ALU.</p> <p>DEBEAURAIN FT MONDIAL SE WINNER</p>		
 GUA-3  GUA-3D	 GR-1I  GR-1D	 GR-3I  GR-3D	 GR-4I  GR-4D
	 GR-2I  GR-2D	PERRIER	
GUERVILLE R.		HÄFELE	
			
 GR-6  GR-6D	 GR-7  GR-7D	 GR-8	 HAF-1  HAF-1D
		MONDIAL	 HAF-4
HÄFELE		HAGA	HALLE
			
 HAF-2  HAF-2D	 HAF-3D	 HAG-1D	 HAL-1

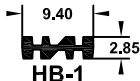

HARKOV			HARLOC
			
 HAK-1D			
 HAK-2D			
 HAK-5	 HAK-3	 HAK-4	 HAR-1
			DNS-EAGLE-LORI

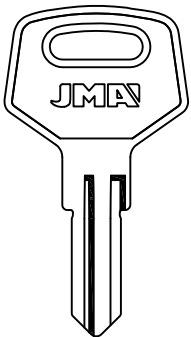
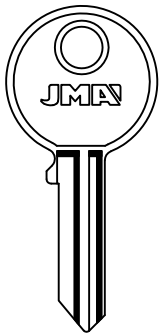
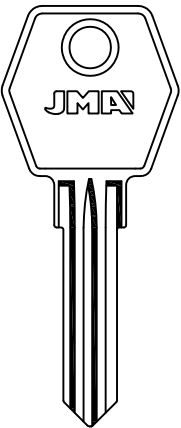
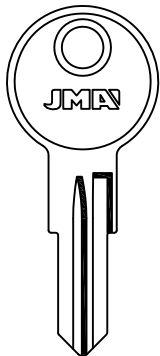
PARA-FOR:
HARKOV (RUS)
HARLOC (USA)
HAYWORTH (USA)
HB (I)
HEKNA (D)
HELIX (RC)
HENDERSON (USA)
HERME (RC)











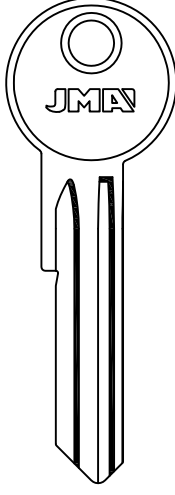
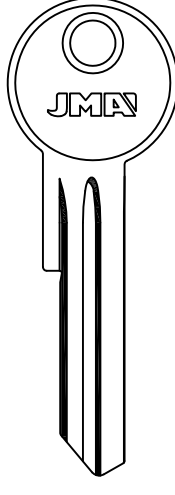
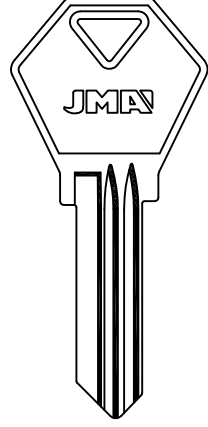
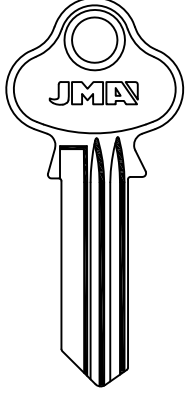



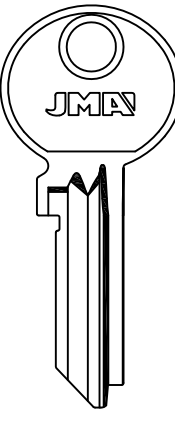
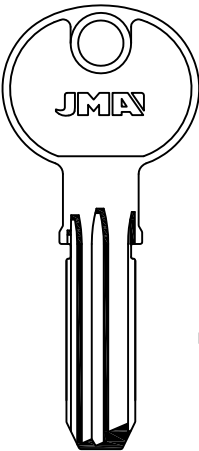
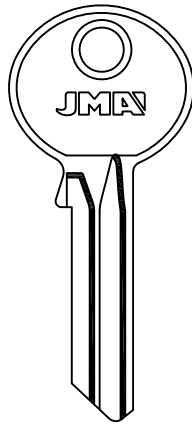
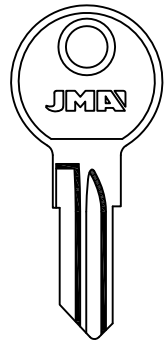

HAYWORTH	HB	HEKNA	
			
LAT.	LAT.1001-1425	
 HAW-1D		 HEK-1	
 HAW-2D		 HEK-2	
 HAW-3D	 HB-1	 HEK-3	 HEK-4
	LEGALLAIS	METALCASTELLI-RAUCO-REGENT	METALCASTELLI-RAUCO-REGENT

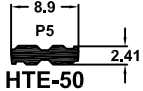
HELIX	HENDERSON		HERME
			
	R 008-254		
 HEL-1	 HEN-1	 HEN-2	 HRM-1
	REAGENT		

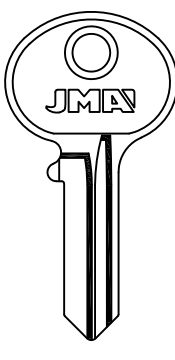
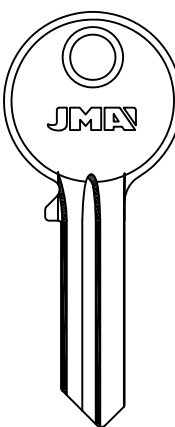
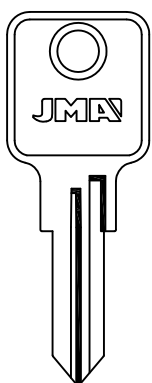
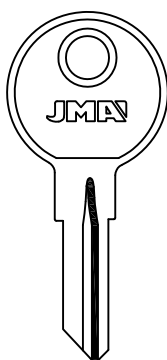





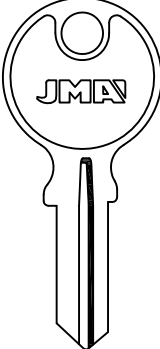
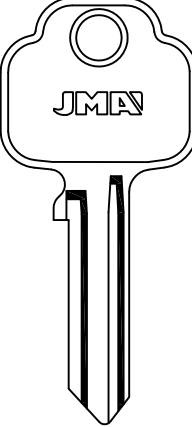

PARA-FOR:

- HOBES (RCZ)
- HORSE (RC)
- HTEC (E)
- HTV (GB)
- HUDSON (USA)
- HUNIT (I)
- HUWIL (D)

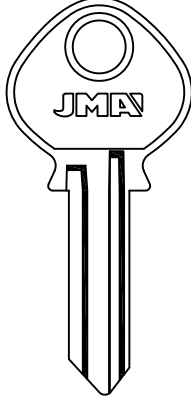
HOBES		HORSE	
			
 HOB-1	 HOB-2D	 HOR-1	 HOR-2  HOR-2D
HTEC		HTV	HUDSON
			
 HTE-1D	8.9 P5  HTE-50 2.41 THT	07  HT-1 VAUGHN	 HUD-2D
LAT.			
HUDSON	HUNIT	HUWIL	
			
 HUD-3	 HUN-1D	 HUW-1	 HUW-2
LAT.	FTH	W 3000-4000 A 3001-4000  HUW-1D	V  HUW-3D
		STRAFOR-STEELCASE	CEKA-HÄFELE-MAUSER-SCHÄRF

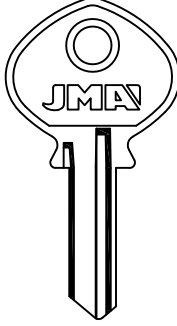

HUWIL	IBEAR	ICA	
 <p>N 0005-1878 N 2001-2204 HUW-N</p> <p>TECNO</p>	 <p>IB-1</p>  <p>IB-2</p> <p>ICA-SERRALLER</p>	 <p>ICA-1</p> 	 <p>ICA-4IP</p> 

PARA-FOR:









HUWIL (D)

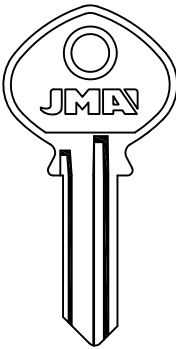

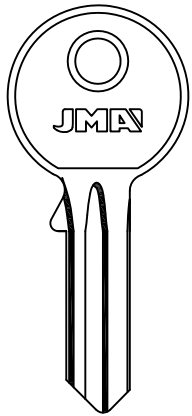

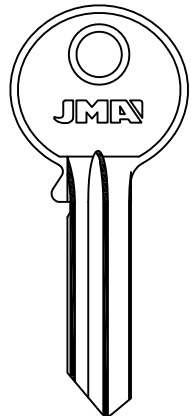

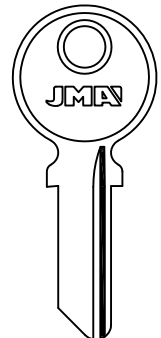

IBEAR (E)

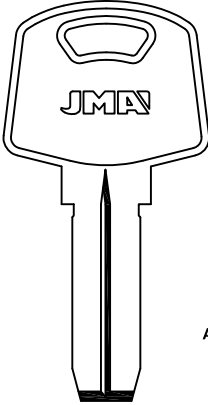
ICA (E)

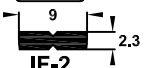
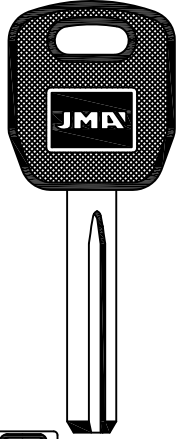
ICSA (I)

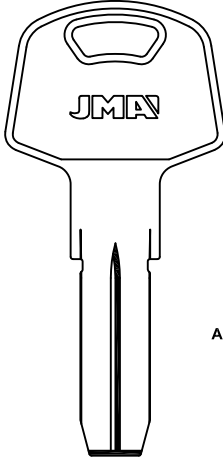
IFAM (E)

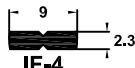
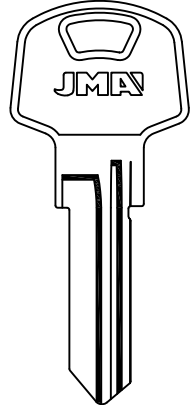
ICA	ICSA		IFAM
 <p>ICA-5IP</p> 	 <p>ICS-1D</p>  <p>ORLANDO-REMO-ZANI</p>	 <p>ICS-2D</p> 	 <p>LAT.</p>  <p>IF-1I</p> <p>JOMA</p>

IFAM			
 <p>ALP.</p>  <p>IF-2</p> 	 <p>ALP.</p>  <p>IF-3.P</p> 	 <p>ALP.</p>  <p>IF-4</p> 	 <p>IF-5</p> 



PARA-FOR:

IFAM (E)

IGS (F)

IKON (D)

IFAM

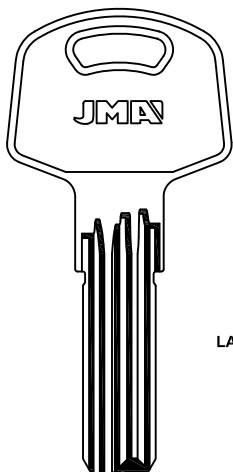

LAT.

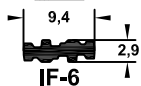

IF-6

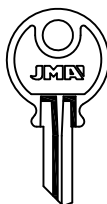

IF-15

TEM

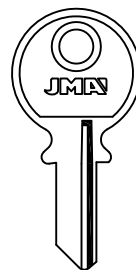

IF-120

ABUS-JOMA-TEM-TESA

IF-D20

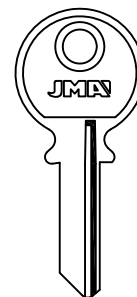

IF-125

* IF-D25

BATU-FADE-JOMA
GUARD-RIPA-TEM

IFAM

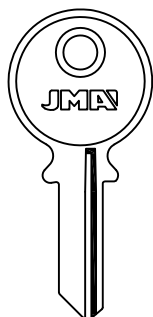

IF-130

JOMA



IF-D30

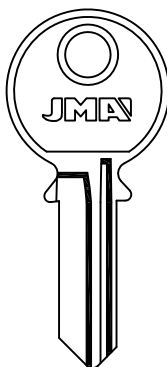

LAT.
ALU.



IF-140

RIPA

IF-35

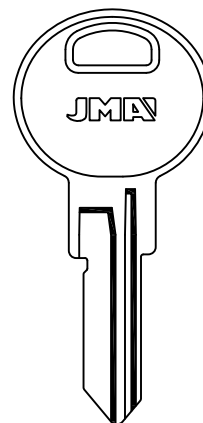

IF-140L

RIPA

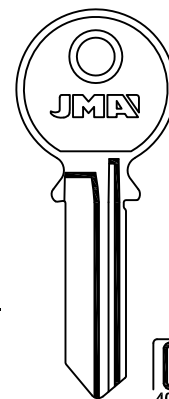

* ALU.
* LAT.
* FSH.



IF-150

50

IF-151

* IF-45/55

IFAM

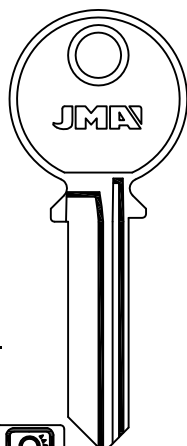

LAT.



IF-160/70

IF-60/70

IGS

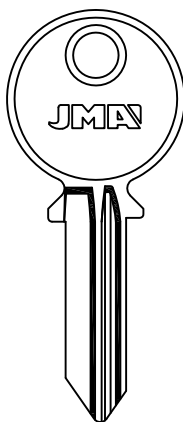

IGS-1

IKON

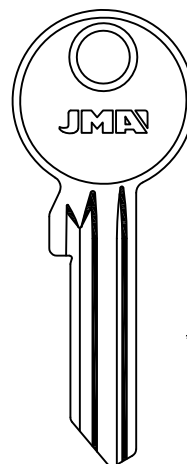

* LAT.

SN4



ZE-1

SN2



ZE-2

N2



ZE-6

SN3



ZE-1D

SN1



ZE-2D

N1



ZE-6D

M



ZE-9D

SN5



* ZE-14D

BRUMME-OTIS



IKON

PARA-FOR:

IKON (D)

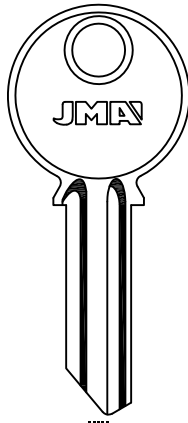

.....
1 AL 9 AL 0
A-B-C-D-E-F-G-H-I-L



BRUMME-OTIS

IKON

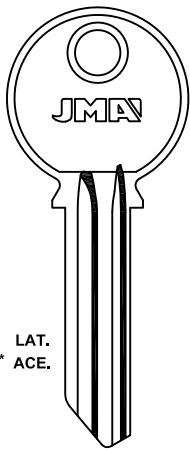

LAT.
* ACE.



LAT.



PARA-FOR:

IKON (D)

IKON

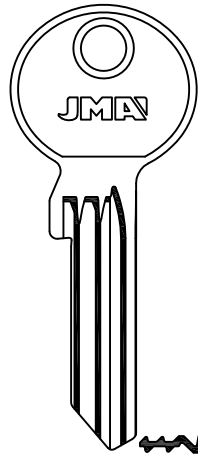

ZE-10D

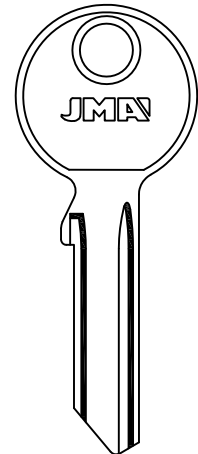

ZE-13

ZE-11D

IKON

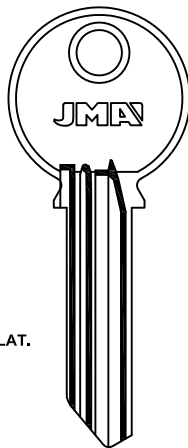

LAT.



ZE-65D



ZE-66D



ZE-67D



ZE-68D



ZE-69D



ZE-110D



ZE-117D



ZE-60D



ZE-61D



ZE-62D



ZE-63D



ZE-64D



ZE-109D



ZE-116D



ZE-55D



ZE-56D



ZE-57D



ZE-58D



ZE-59D



ZE-108D



ZE-115D



ZE-50D



ZE-51D



ZE-52D



ZE-53D



ZE-54D



ZE-107D



ZE-114D



ZE-33D



ZE-34D



ZE-47D



ZE-48D



ZE-49D



ZE-106D



ZE-113D



ZE-28D



ZE-29D



ZE-30D



ZE-31D



ZE-32D



ZE-105D



ZE-112D



ZE-23D



ZE-24D



ZE-25D



ZE-26D



ZE-27D



ZE-70D



ZE-111D



ZE-147D



ZE-146D



ZE-145D



ZE-141D



ZE-136D



ZE-127D



ZE-126D



ZE-125D



ZE-148D

LAT.

PERFIL Z SERIE 400



IKON

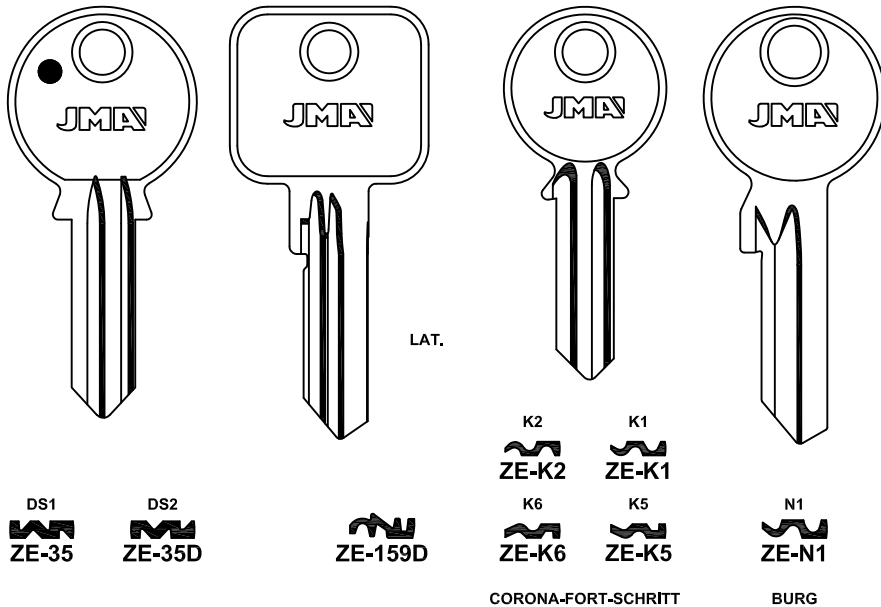

ILARGI

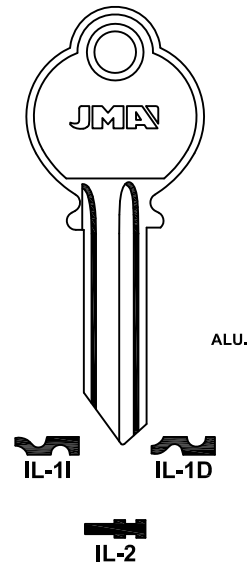

PARA-FOR:

IKON (D)
ILARGI (E)
ILCO (USA)
ILLINOIS (USA)
ILS (I)
IMB (KW)

ILCO

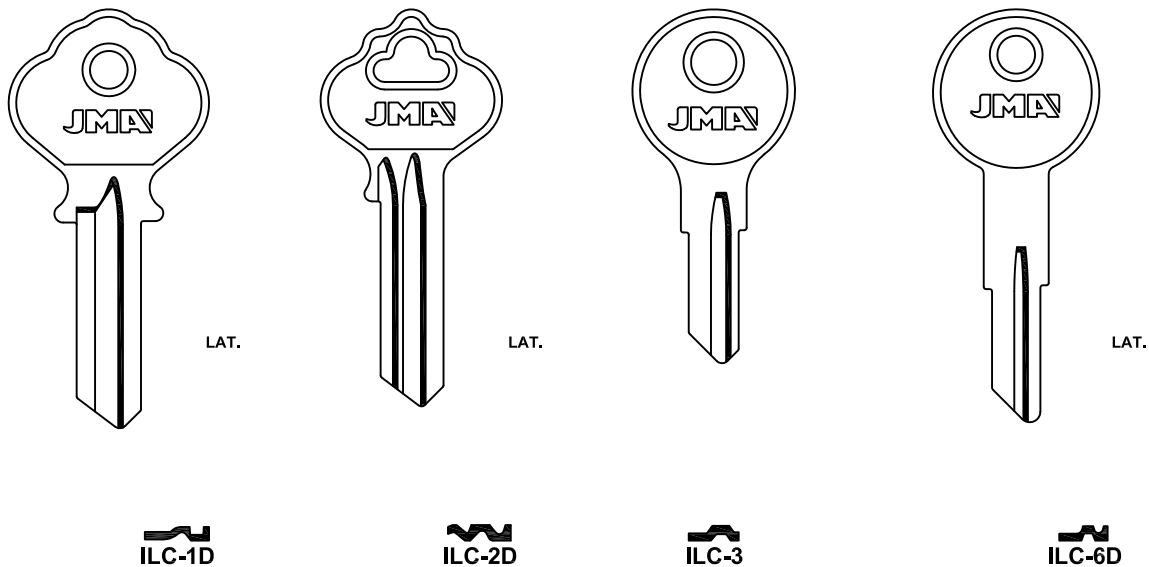

ILLINOIS

ILS

IMB

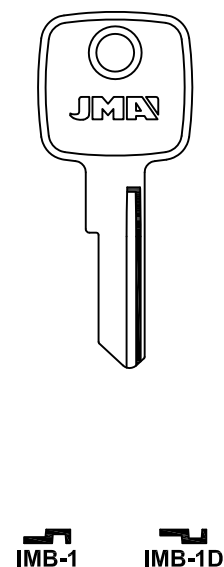
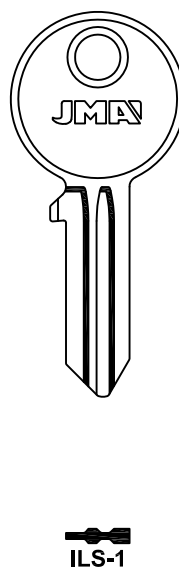
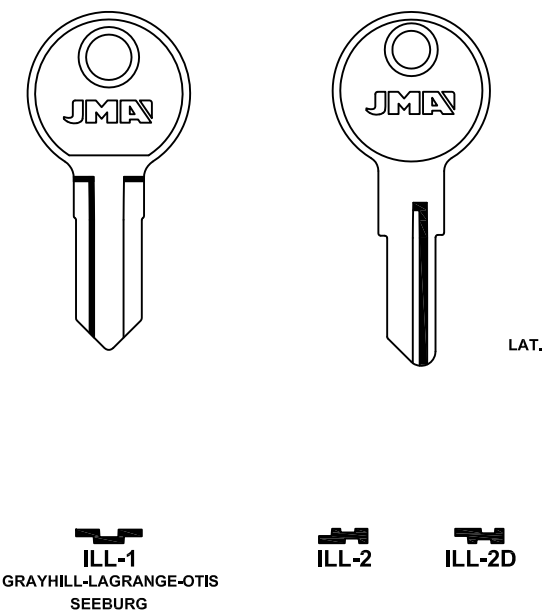

PARA-FOR:











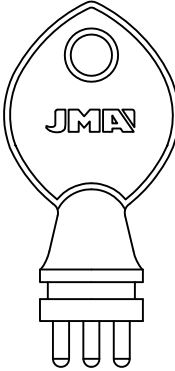
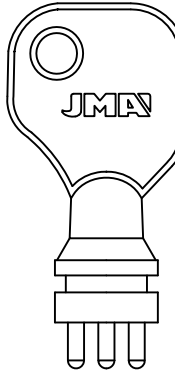

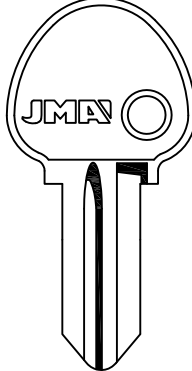





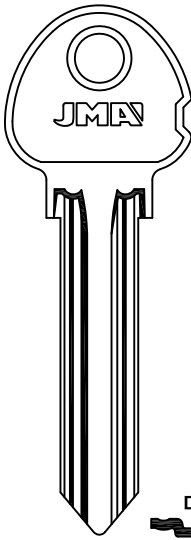
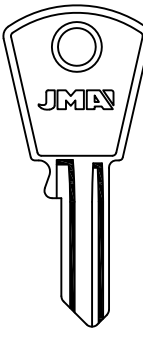

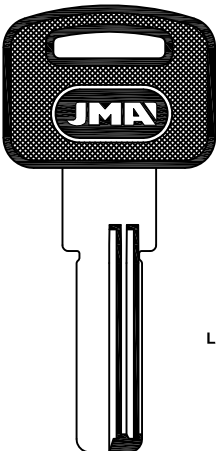
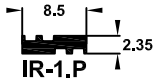
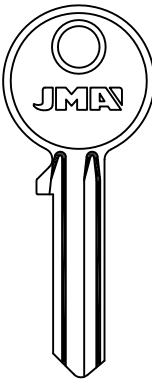
INCECA (E)

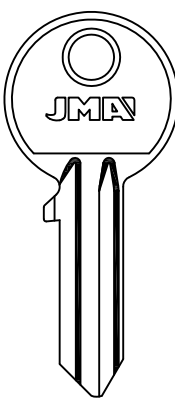
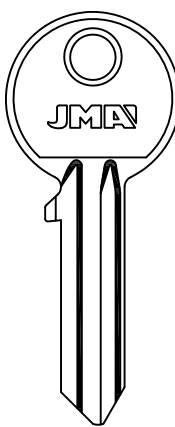
INGERSOLL
(USA)

INT (D)

IR (F)



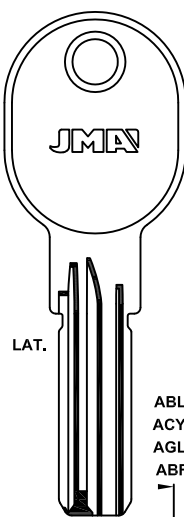
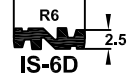



ISEO (I)



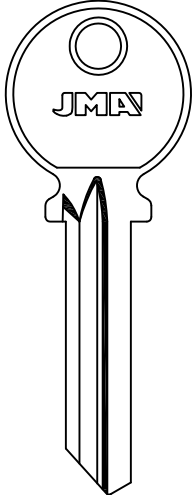
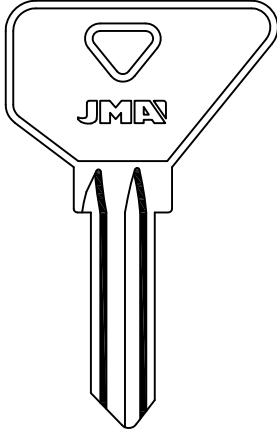
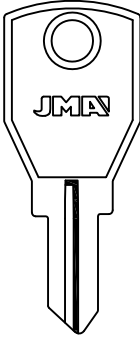
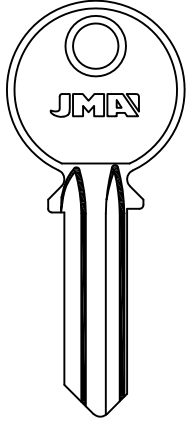



INCECA		INGERSOLL	
 <p>LAT.</p>  <p>LAT.</p>  <p>INCE-1E</p>  <p>INCE-2E</p>		 <p>ING-6</p>  <p>A 1 AL 4 ING-A</p>  <p>M ING-M</p>  <p>ING-N</p>  <p>S 1 AL 4 ING-S</p>  <p>W ING-W</p>	
INGERSOLL	INT	IR	ISEO
 <p>ING-D</p>	 <p>LAT.</p>  <p>INT-1 INT-1D</p>	 <p>LAT.</p>  <p>8,5 2,35 IR-1.P BYP-IFAM</p>	 <p>ALU.</p>  <p>1 AL 5 IS-1I IS-1D TESA</p>
ISEO			
 <p>....1-2000 Y....1-2000 0 AL 8</p> <p>IS-2I IS-2D</p>	 <p>* ALU.</p> <p>IS-3I * IS-3D</p> <p>F5</p>	 <p>IS-4</p> <p>....1-2000 Y....1-2000 0 AL 8</p>  <p>IS-5D</p>  <p>IS-7D</p>  <p>IS-8</p>  <p>IS-8D</p>  <p>IS-18D</p>  <p>IS-19D</p>	 <p>LAT.</p>  <p>ABL.....1-015328 ACY.....1-015328 AGL.....1-015328 ABF.....1-015694 9,4 R6 2,5 IS-6D</p> <p>MD-VACHETTE</p>



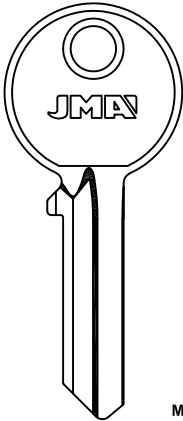
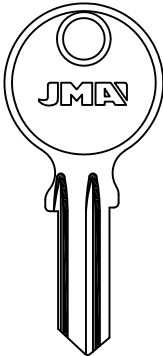
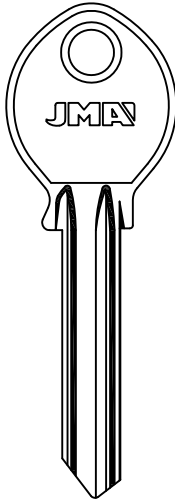
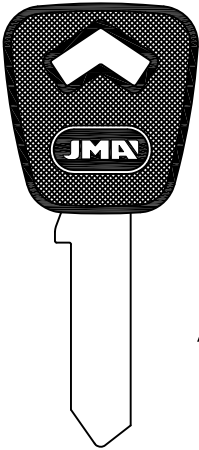





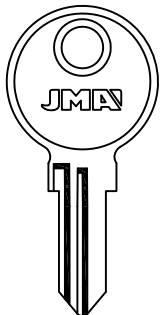
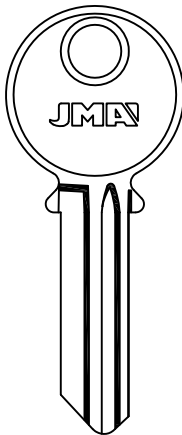

PARA-FOR:

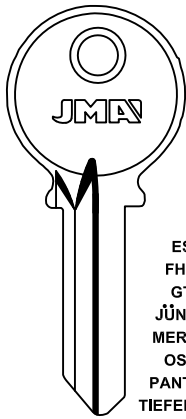
- JARDI (E)
- JINLONG (RC)
- JIP (E)
- JIS (E)
- JOMA (E)
- JOVI (E)
- JOWIL (D)

JARDI	JINLONG	JIP
 		
  		 

JIS			
			
<p>ALU. LAT. FSH. MTIC.(J)</p>		<p>LAT. ALU.</p>	<p>ALP.</p>
		 	
SEMEL			

JOMA	JOVI	JOWIL	
			
		 	<p>ESZ FHÜR GTV JÜNGST MERCUR OSKO PANTHER TIEFENTHAL TRITON VOKO WEPA</p> 
GTV			



JOWIL

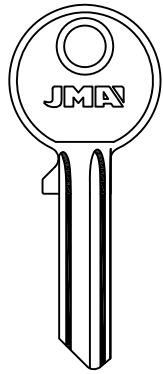

JWL-5

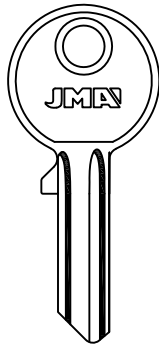

JWL-6

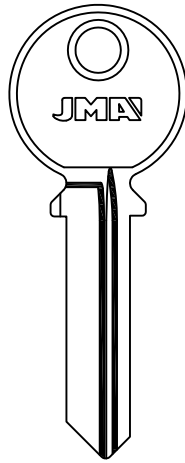

JWL-7D

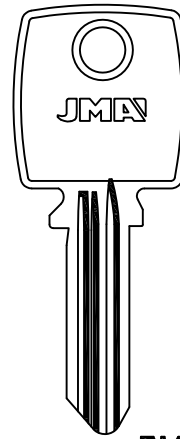

JWL-10D

JWL-11D

LAT.

PARA-FOR:

JOWIL (D)

JPM (F)

JTF (F)

JPM

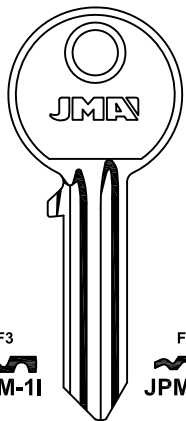

F3
JPM-1I



F3
JPM-1D

JPM-2I

JPM-2D

JPM-4

JPM-4D

ABUS

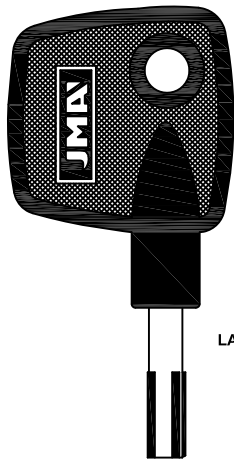

LAT.

JPM-1E

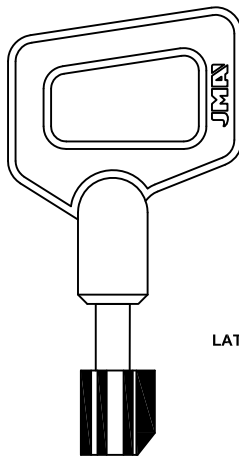

LAT.

JPM-2E

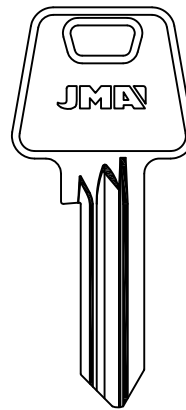

JPM-3D

JPM

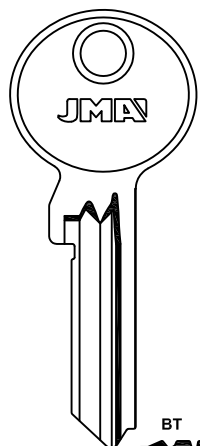

BT
JPM-10D

BK
JPM-11D

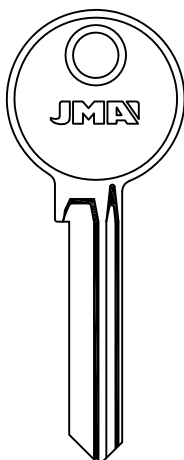

JTF-1I

JTF

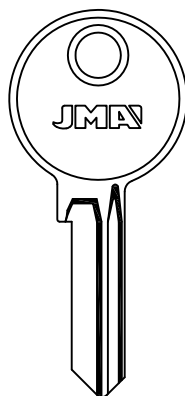

JTF-2I

JTF-3

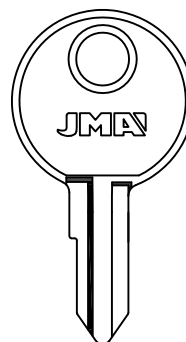

JTF-4



PARA-FOR:

- JU-JUNGINGER (D)
- JUNGHEINRICH (D)
- JUNIE (D)
- JUNKUNG (USA)
- JUZU (E)
- JVAL (P)
- KABA (CH)

	JU-JUNGINGER	JUNGHEINRICH	JUNIE	
	 	 	 <p>PEROHAUS-US</p>	 <p>PEROHAUS-US</p>
	JUNIE	JUNKUNG	JUZU	
	 	 <p>LAT.</p> <p>A.MOTORS-BULIT-LION</p>	 <p>ALSO-A.MOTORS-BULIT-LION</p>	
	JVAL		KABA	
	 <p>P.C.-FEB</p>	 <p>P.C.-FEB</p>	 <p>S15-S16 S17-S18 S53-S58 S59-S61</p> <p>LÄSBOLAGET</p>	 <p>* ALU. ALP.</p> <p>GEMINI</p>



KABA

PARA-FOR:

KABA (CH)

KABS (D)

KALE (TR)

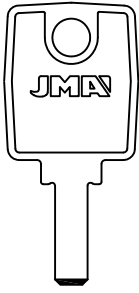

ALP.

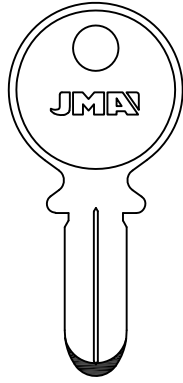

ALP.

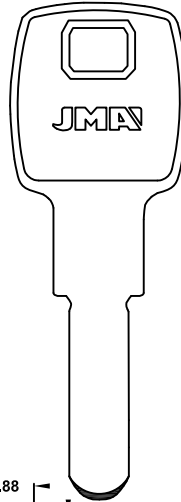

ALP.

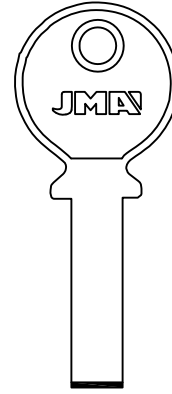

ALP.

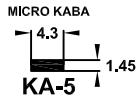

KA-5



KA-6

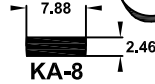

KA-8

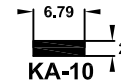

KA-10

KABA

KABS

KALE

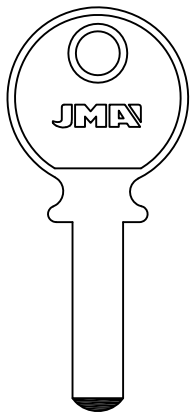

ALP.

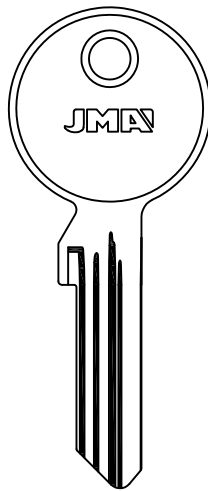

KAB-1D

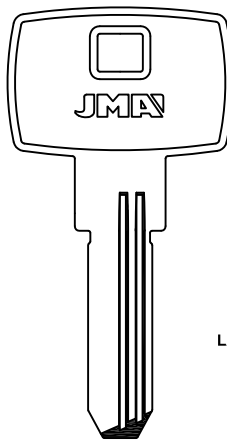

LAT.

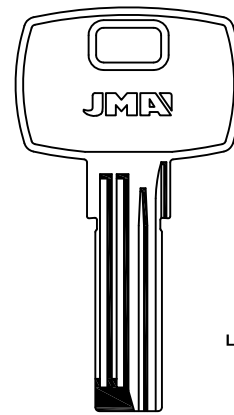

LAT.

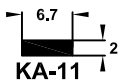

KA-11



KAE-1

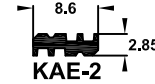

KAE-2

KALE

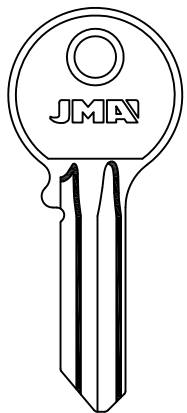

KAE-3

KAE-3D

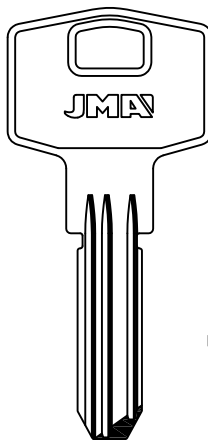

LAT.

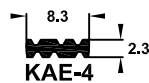

KAE-4

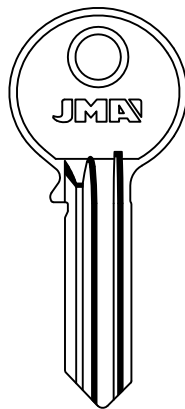

KAE-5

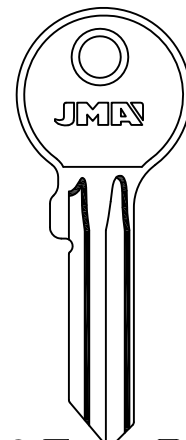

KAE-6

KAE-6D

KAE-7

KAE-7D



PARA-FOR:

- KALE (TR)
- KALUGA (RUS)
- KAP (RUS)
- KAZAN (RUS)

KALE

LAT.

LAT.

KAE-8 KAE-8D

KAE-9 KAE-9D

KAE-10D

KAE-11D

KAE-12D

KAE-13D

FAC-GAON JIS FAC

KALE KALUGA KAP KAZAN

LAT.

LAT.

KAE-14

KAL-1

KAL-2D

KAP-1D

KAP-2D

KAZ-1

KAZAN

KN

KAZ-2

KAZ-3

KAZ-4

KAZ-5

KAZ-5D



KAZAN

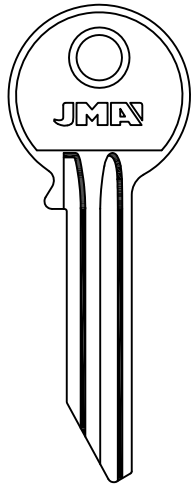

KAZ-6

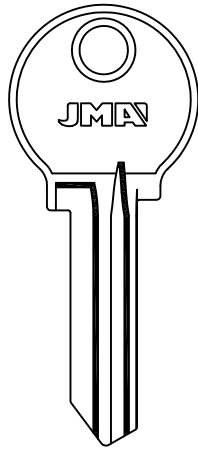

KAZ-7

KESO

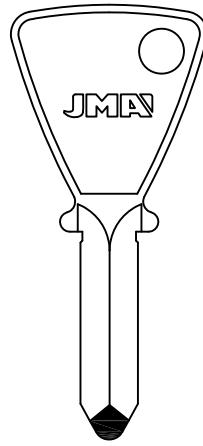

KE-1

JPM

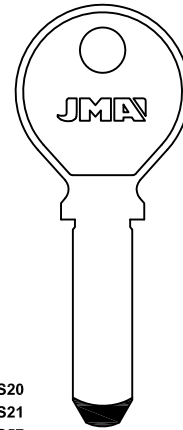

KE-3

S20
S21
S57

ALP.

PARA-FOR:

- KAZAN (RUS)
- KESO (CH)
- KFV (D)
- KICHINEV (RUS)
- KIFERM (F)

KESO

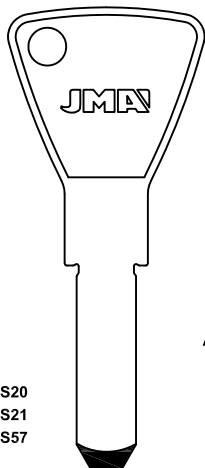

ALP.

S20
S21
S57

KE-4

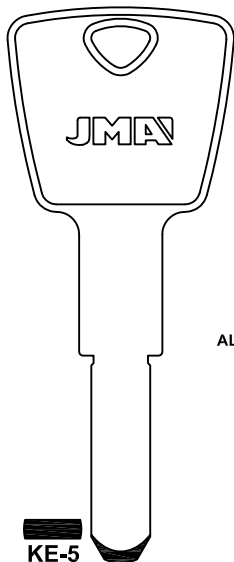

ALP.

KE-5

KFV

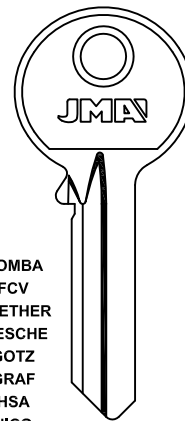

ALU.

- COMBA
- FCV
- FLIETHER
- GIESCHE
- GOTZ
- GRAF
- HSA
- NICO
- SEN
- SCHUCO

KFV-1

KFV

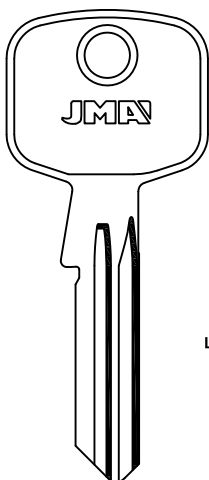

LAT.

- KFV-O**
- KFV-N**
- KFV-M**
- KFV-L**
- KFV-F**
- KFV-E**
- KFV-D**
- KFV-C**

COMBA-FCV-FLIETHER-GIESCHE
GOTZ-GRAF-HSA-NICO-SCHUCO-SEN

KICHINEV

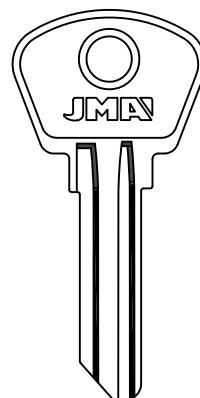

KIC-1

KIFERM

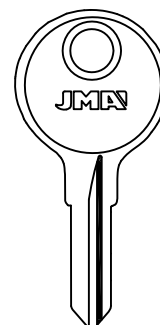

KIF-1











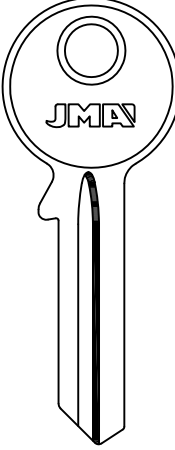

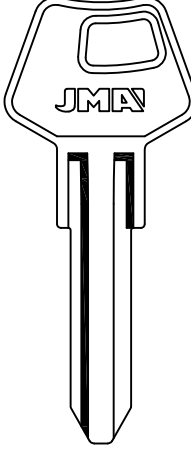

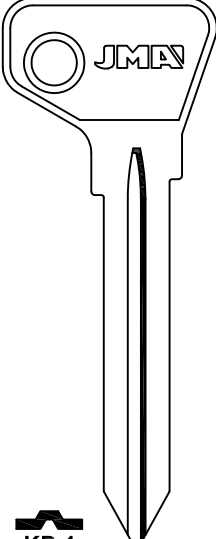

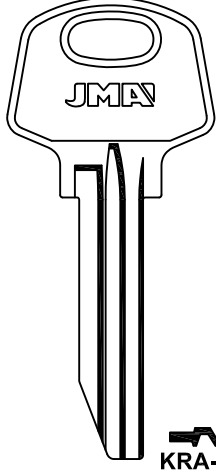

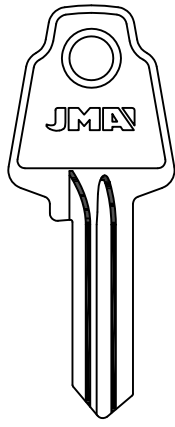

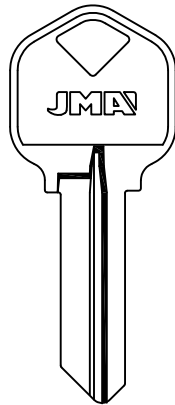

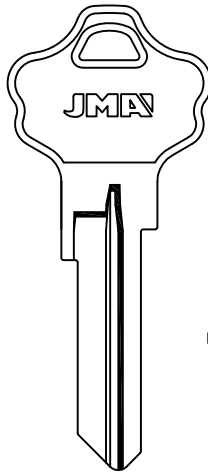

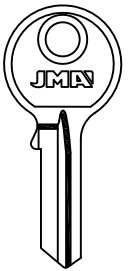
KIF-1D

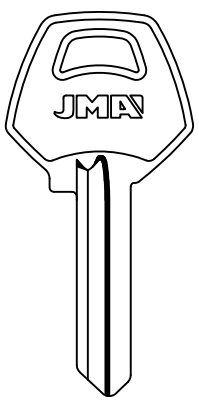
KIF-2D

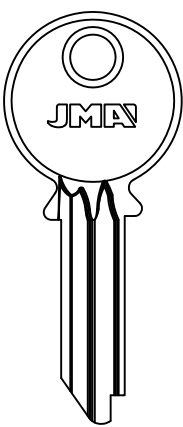

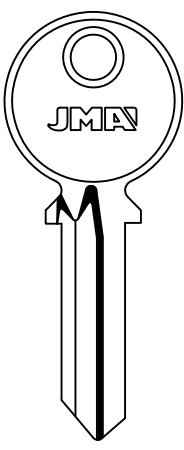
PARA-FOR:

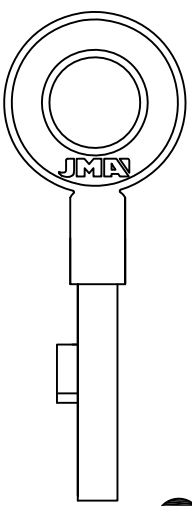
- KIROVMACH (RUS)
- KP (RUS)
- KRAMATORSK (RUS)
- KREMENCHUG (RUS)
- KWIKSET (USA)
- KYNNARPS (GB)
- LAFONTE (BR)
- LAPERCHE (F)

KIROVMACH	KP		KRAMATORSK
  KIR-1D	  KIR-2	  KP-1	  KRA-1D  KRA-2
KREMENCHUG	KWIKSET		KYNNARPS
  KRE-1D	 <p>ACE. LAT.</p>  KWI-1 1 AL 7 BRICARD-EZSET-VACHETTE	 <p>LAT.</p>  KWI-2D TITAN	  KNA-1D
LAFONTE	LAPERCHE		
  LAF-1D	  LAP-1 DM	  LAP-2D	 <p>LAT.</p>  LAP-2E



LAPERCHE

PARA-FOR:
LAPERCHE (F)

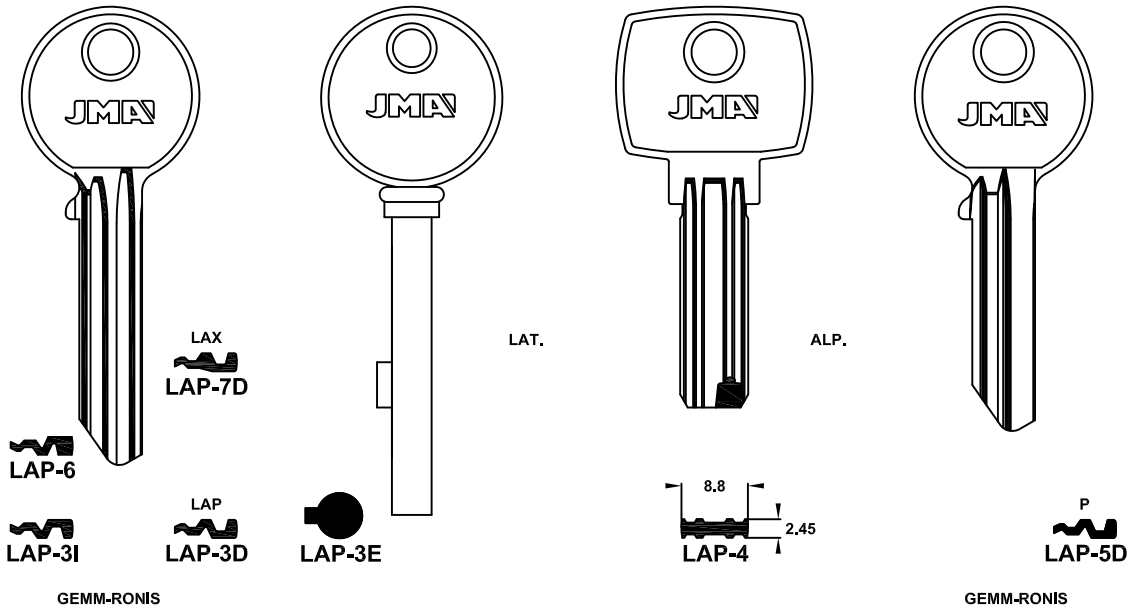

LAPERCHE

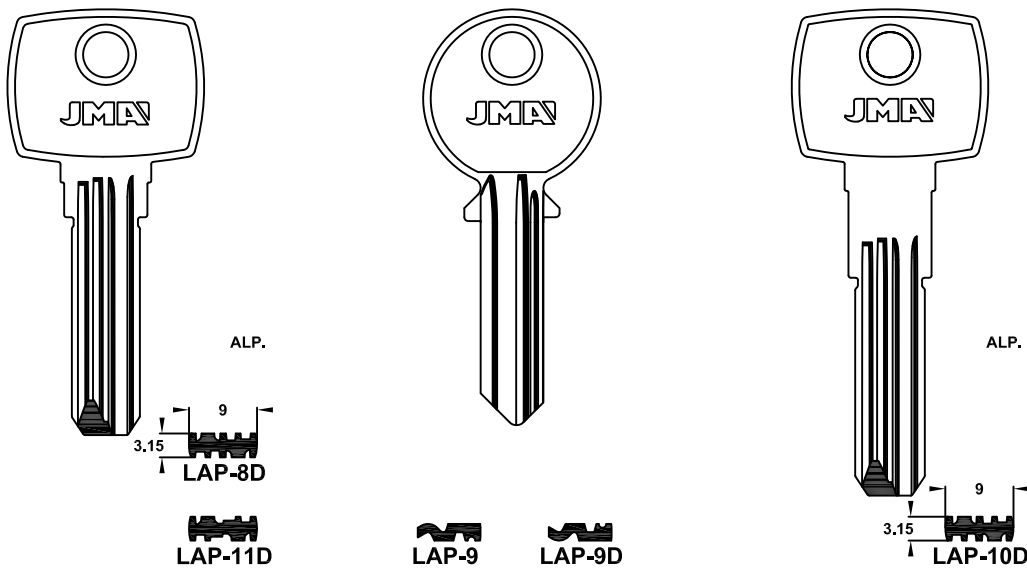

LAPERCHE

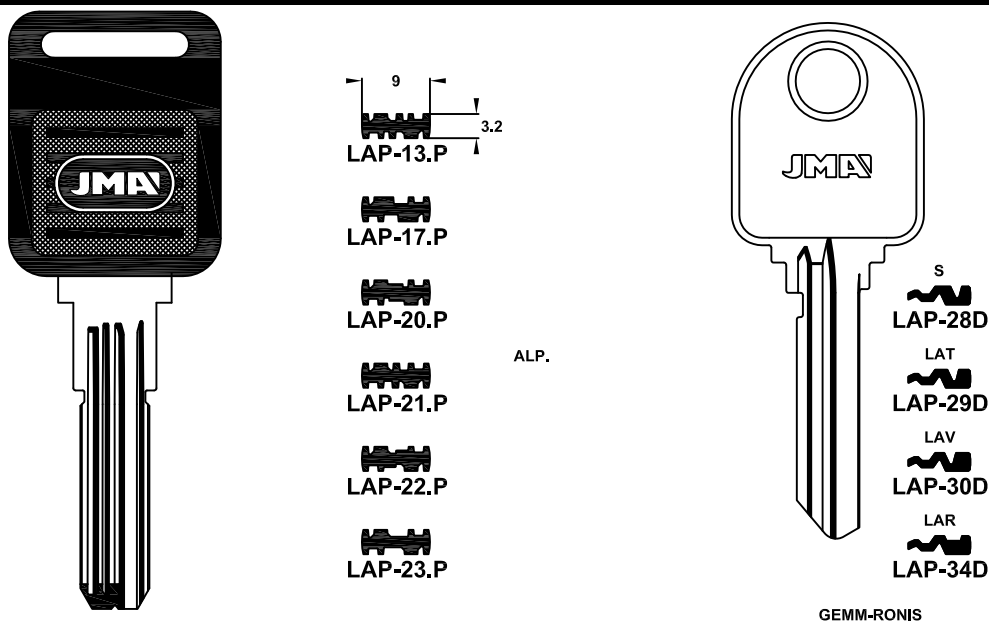

PARA-FOR:

LAPERCHE (F)

LAPORTE (F)

LARK (RC)

LAS (F)

LAPERCHE

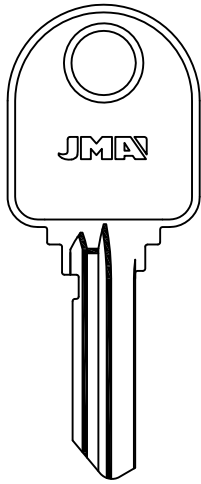

- S
LAP-42D
- X
LAP-43D
- T
LAP-44D
- V
LAP-45D
- R
LAP-46D

GEMM-RONIS

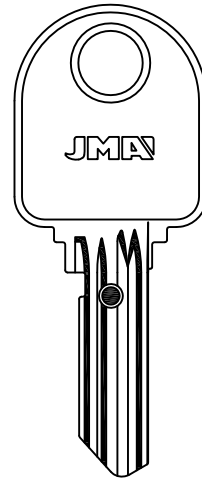

- BDC
LAP-88

FICHET

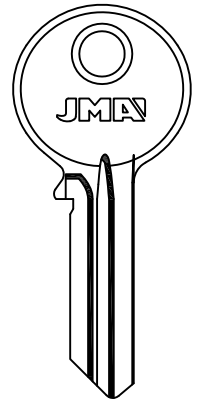

- LAP-96D

VACHETTE

LAPORTE

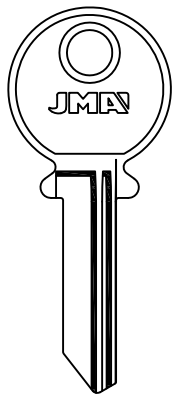

- LPO-1

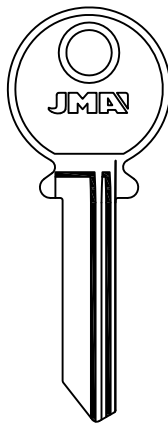

- LPO-2

LARK

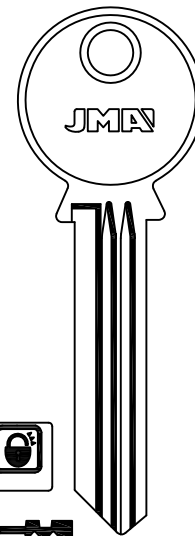

- LAR-11

LAS

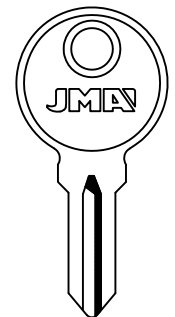

- AX
001-224
LAS-AX

- EX
LAS-1D

ATAL-HÄFELE-KIFERM-RENZ

LAS

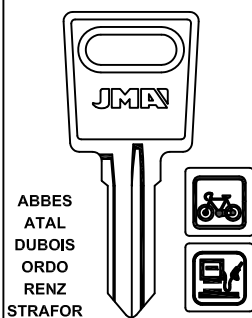

ABBES
ATAL
DUBOIS
ORDO
RENZ
STRAFOR

- FM
LAS-2

- FM
001-400
501-550
LAS-4

- LAS-4



- FH
001-400
501-550
LAS-FH

- H
LAS-5

- U
LAS-U

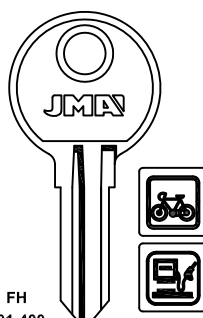

- FH
001-400
501-550
LAS-3

- H
LAS-5

- U
LAS-U

- LAS-4



- E
LAS-5D

- X
LAS-X

KIFERM

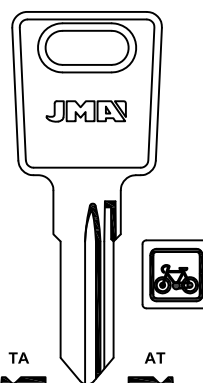

- TA
LAS-6

- RM
0001-2000
KT
3001-4000
LAS-KT

- LAS-KT

- AT
LAS-6D

- TK
4001-5000
LAS-TK

- LAS-TK

ATAL-KIFERM-MARCADET-RONIS

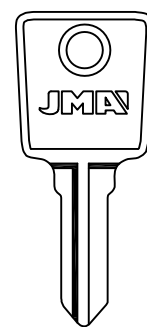

- LAS-7

- LAS-7

ABBES-ORDO

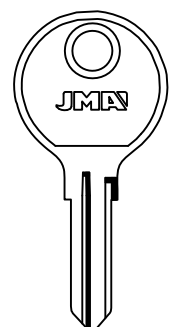

- LS
LAS-8

- L
LAS-9

ABBES-ORDO



LAS

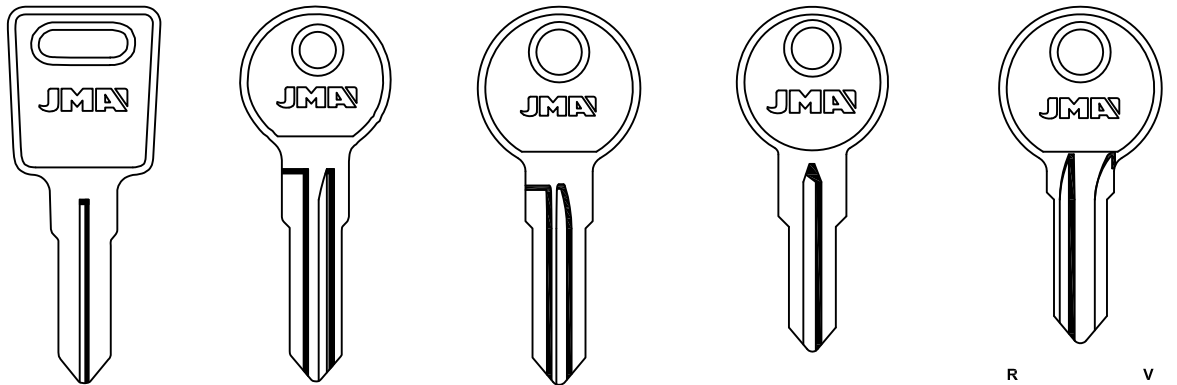

PR
LAS-10

LAS-11

A...1-650
LAS-11D

LAS-12D

AX
001-224
LAS-AX/L

R
001-224
LAS-R

V
001-224
LAS-V



Y
001-224
LAS-Y

MARCADET

ATAL-KIFERM-RENZ

ATAL-HÄFELE-KIFERM-RENZ

DUBOIS-KIFERM-PJ-PK

PARA-FOR:

LAS (F)

LÅSBOLAGET (S)

LEGALLAIS (F)

LEGE (GB)

LINCE (E)

LAS

LÅSBOLAGET

LEGALLAIS

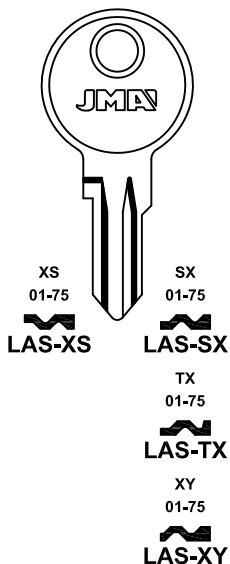

ATAL-JU-KIFERM-METEOR-RENZ

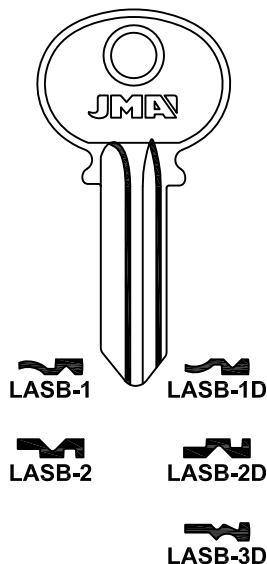

TANLOCKS

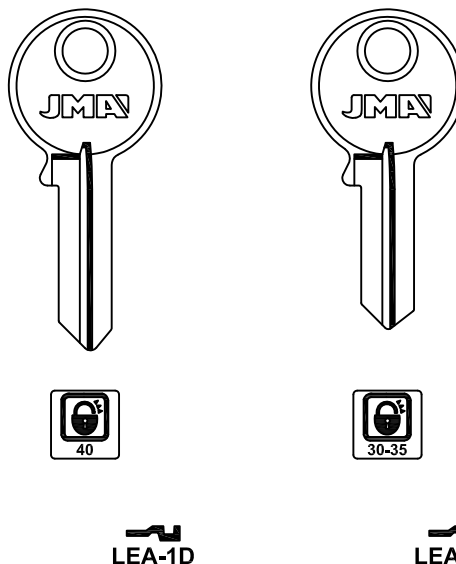

LEGE

LINCE

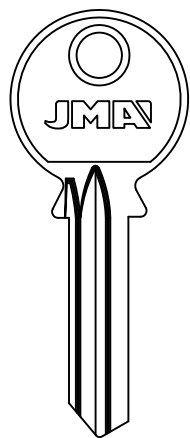

1 AL 7
LEG-1D

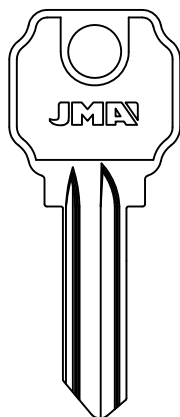

A
LIN-11

A
LIN-1D

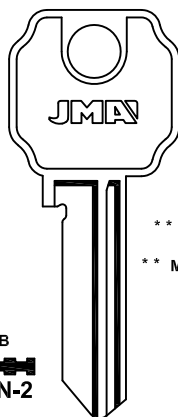

B
LIN-2

C
LIN-31

R
LIN-151

NO COL.
50-60-70
LIN-15D

** FSH.
** MTIC.(L)
* LAT.
* ALU.

LIN-4

LIN-14

70-90

N
LIN-41

N
LIN-4D

LIN-141

LIN-14D

U (A)
LIN-20D



PARA-FOR:

LINCE (E)

LIPS (NL)

LINCE

* LAT.

* LIN-5I * LIN-5D

LIN-12I LIN-12D LIN-6I LIN-6D LIN-7I LIN-7D LIN-8I LIN-8D

LIN-18 LIN-18D LIN-17 LIN-17D

30-40 20-25 25

LINCE

ALP.

LIN-9 LIN-10I LIN-10D LIN-11I LIN-11D LIN-13

LIN-16 LIN-16D

60-70 60-70 15

9 2.45

LINCE

LIPS

LAT.

LAT. WNC.

LIN-19D LIN-21D LIN-25 LIN-25D LIP-11 LIP-1D

9 2.45 30 35

CRAIN-ICSA-SIB



LIPS

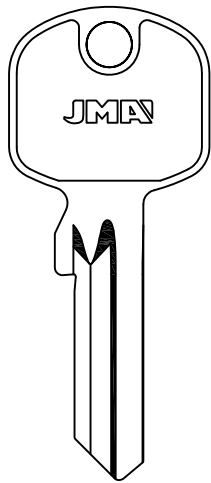

35
LIP-1GD

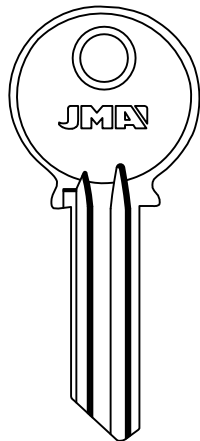

34
LIP-2

29
LIP-2D

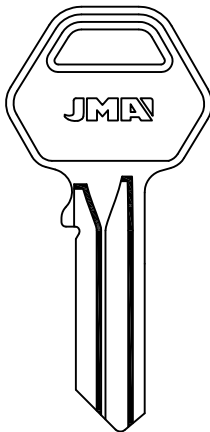

26
LIP-3

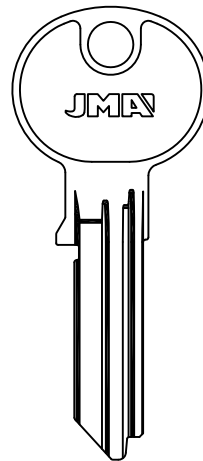

E03
LIP-4

PARA-FOR:

LIPS (NL)

LITTO (B)

LOB (PL)

LIPS

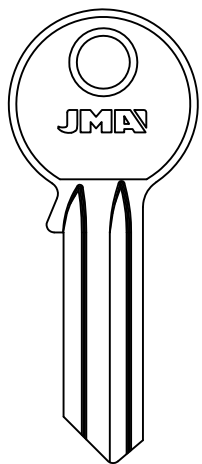

33
LIP-33

28
LIP-28D

LITTO

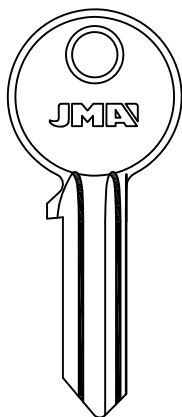

E
LIT-11

ANKERSLOT

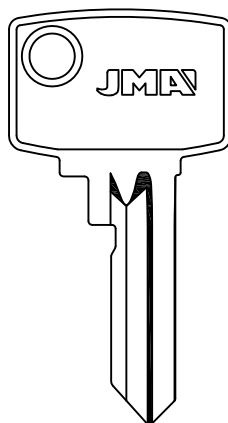

LIT-2D

ALU.
MTIC.

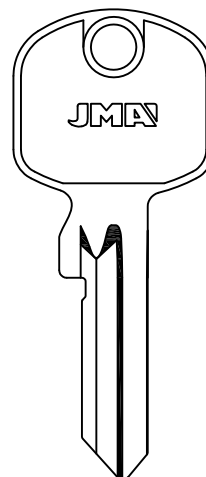

LIT-2GD

LITTO

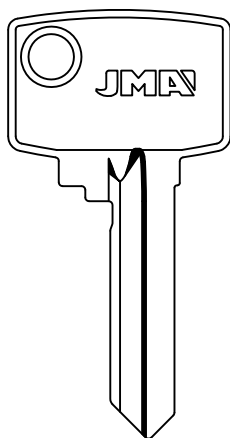

LIT-3D

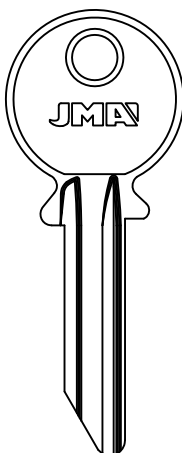

LIT-5I

LIT-5D

BKS

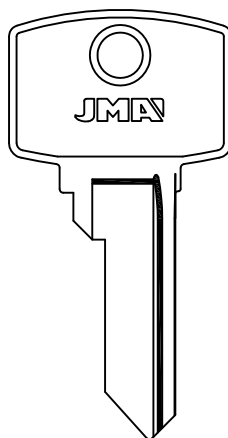

LIT-7D

LOB

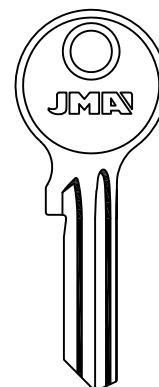

LB-1







LB-1D



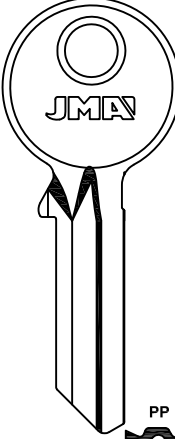
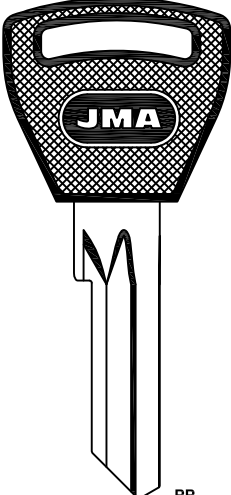
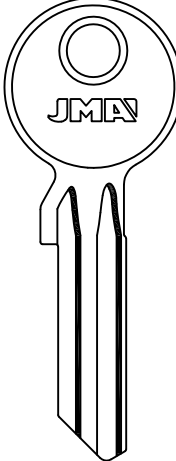
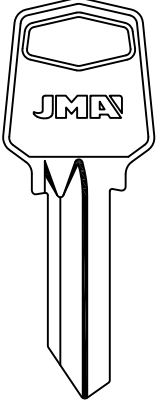





EXPRES

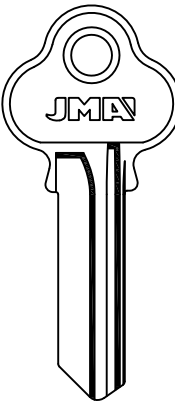
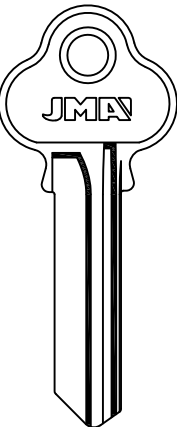
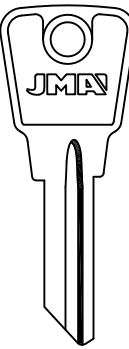
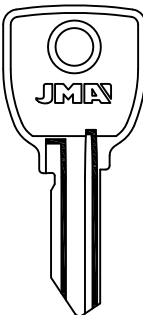
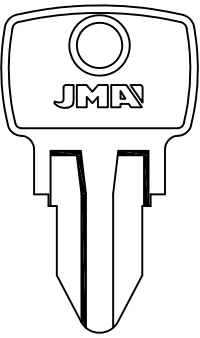









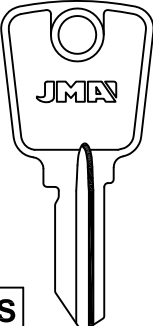
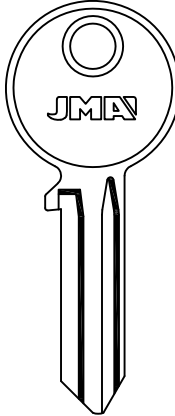
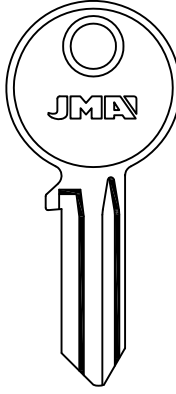
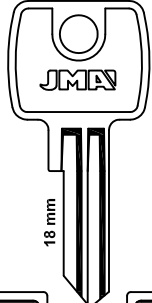

PARA-FOR:

- LOB (PL)
- LOCK (MEX)
- LOCKWOOD (USA)
- LOGO (I)
- L.&F. (GB)

LOB			LOCK	
				
 PP LB-2D  LB-4D	 PP LB-2D.P	 LB-3  LB-3D	 LOC-1D ACE. LAT.	
BRICARD-EXPRES-REDY-YETI		BRICARD-EXPRES-REDY-YETI		

LOCKWOOD				
				
 0 AL 9 A LWO-1  LWO-1D	 0 AL 9 A LWO-2  LWO-2D	 24A LWO-7D	 CL.. 1-1000 LWO-8	 N LWO-9
GAINSBOROUGH				LEN-LOK

LOCKWOOD	LOGO		L. & F.
			
AUS	ALU.		18 mm
 ...151-250 L...1-960 ...1-960 LWO-26D	 LO-1I  LO-1D  LO-3D	 LO-2I  LO-2D  LO-4D	 90...1-200 ...1-400 91...201-275 GH...1-4000 SS...1-400 91...276-350 LF-1I  LF-1D
LEN-LOK	CISA	CISA	CEM-EURO LOCKS-UNION



LOWE & FLETCHER

PARA-FOR:

L.&F. (GB)

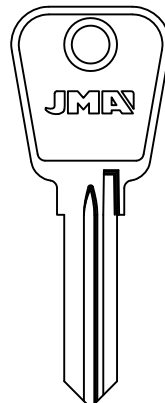
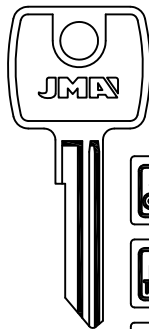
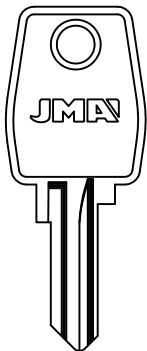
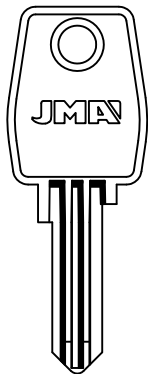

95001-97000
97001-99000



LF-2

....
70001-71000
M....
70001-71000



LF-5



LF-5D

....
66001-67200



LF-7

....
81001-87000



LF-7D



LF-12 LF-12D

BICICLETTA CYCLES

DOBLE SAFE-EURO LOCKS



LF-4I

EURO LOCKS



LF-32

TELFORD

FORD EUROPA

LOWE & FLETCHER

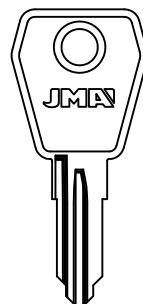
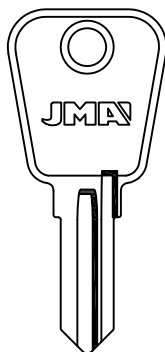
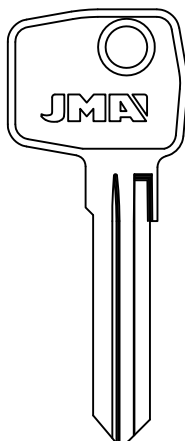
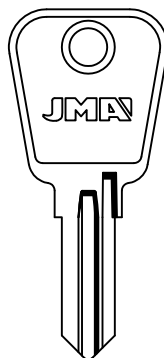

93...201-400
.....93901-94000



LF-8



LF-8D

93...401-900
.....90901-90975



LF-11



LF-11D

EURO LOCKS-MIBRA-UTZ



LF-10

EURO LOCKS

93...201-400
.....93901-94000



LF-13



LF-13D

MIBRA-UTZ



LF-14D

EURO LOCKS

LOWE & FLETCHER

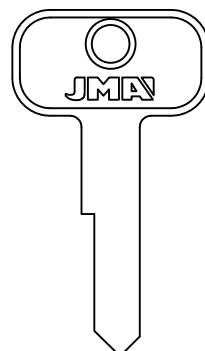
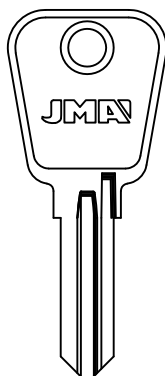
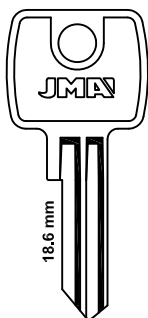

18.6 mm

60... 001-200
60... 001-200
90... 001-200
...1-400
GHM...1-155
M...1-400
RV...1-400
RVM...1-400
SP...1-400
99...1-400



LF-15

FFE
001-100



LF-17

CEM-EURO LOCKS-ULTRA-UNION



LF-16



LF-18D

JMA[®]

Copyright by Alejandro Altuna S.A. 2014



ATENCIÓN: Concerniente a las marcas y denominaciones comerciales ver nota en índice.
ATTENTION: Concerning the marks and commercial denominations see note in index.
ATTENTION: Concernant les marques et dénominations commerciales voir la note dans l'index.
ACHTUNG: Beziehen auf die marke und handelsname sehen sie die notiz im index.

PARA-FOR:

L.&F. (GB)

LOWE & FLETCHER

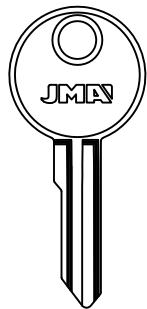

LF-19

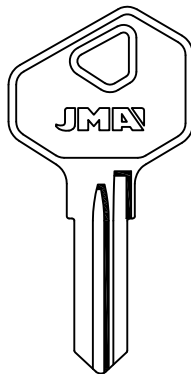

LF-20

19...1-420
....17001-19000
....7001-9000

LF-20D

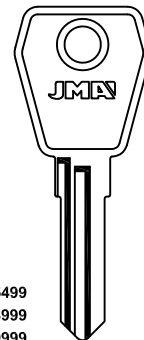

....35000-35499
....78000-78999
....79000-79999

LF-21

LF-33D

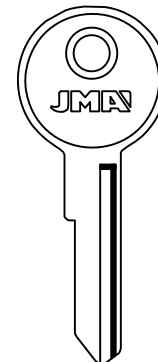

LF-22

LOWE & FLETCHER

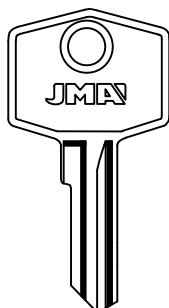

LF-23

ULTRA

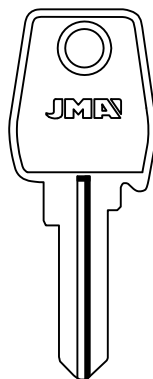

LF-24

DOBLE SAFE-EURO LOCKS

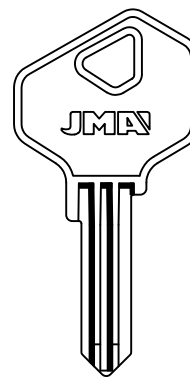

V..1-88
LF-25

14001-14088

LF-40

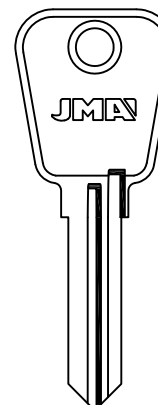

LF-26

LOWE & FLETCHER

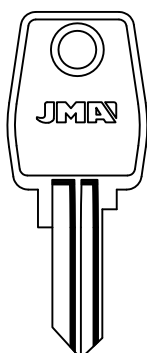

LF-27

EURO LOCKS

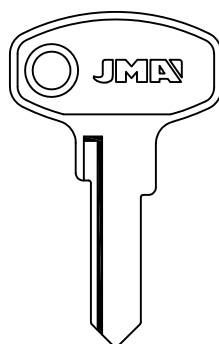

LF-28

EURO LOCKS

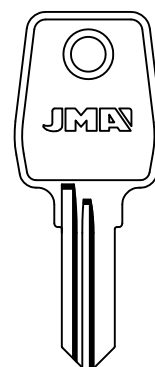

93...401-900
....90901-90975

LF-29D

EURO LOCKS

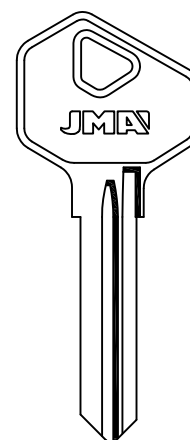

09...1-900
29...1-478

LF-30



LOWE & FLETCHER

PARA-FOR:

L.&F. (GB)
 LT (PRC)
 LUCKY (RC)
 LUMA (E)

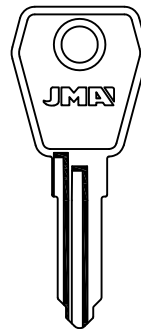
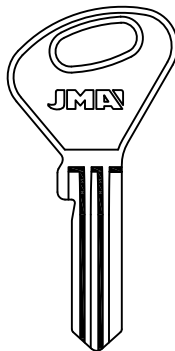
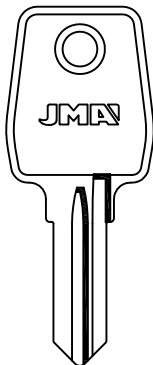
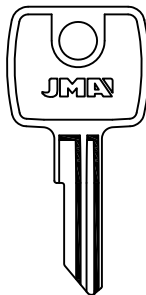
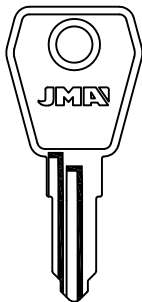

LF-31

LF-34

R...201-600
 ...9001-9494

LF-35

LF-36

LF-37D

LF-38D

LOWE & FLETCHER

LT

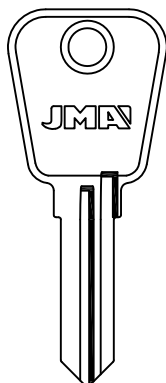

LF-41

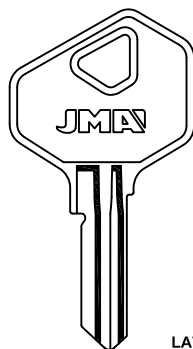

LAT.

92...601-800

LF-44

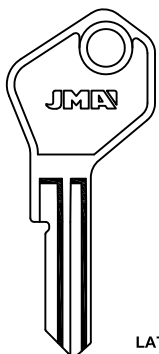

LAT.

92...1-400
 60...001-400
 ...1-400
 ...RV1
 ...ES1
 91...201-350
 M...1-400

LF-45

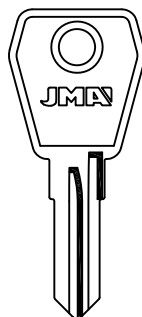

LF-46

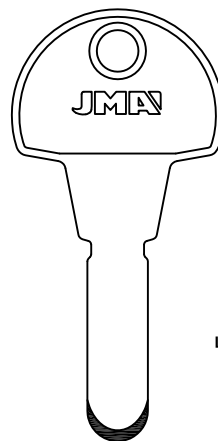

LAT.



LT-1

LUCKY

LUMA

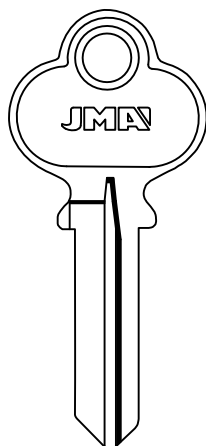

LUC-1D

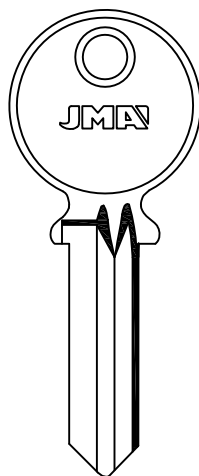

LUC-2

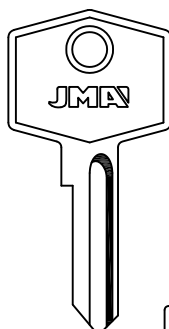

A1101-A1112

LUMA-1I

B3301-B3312

LUMA-2I

A2201-A2212

LUMA-1D

B4401-B4412

LUMA-2D

C5501-A5512

LUMA-3I

LUMA-4I

C6601-C6612

LUMA-3D

LUMA-4D

BASTA

JMA[®]





Copyright by Alejandro Altuna S.A. 2014





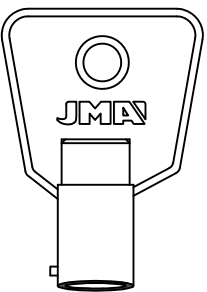
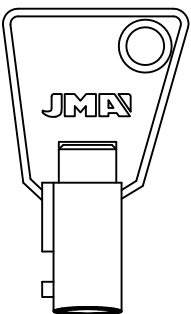
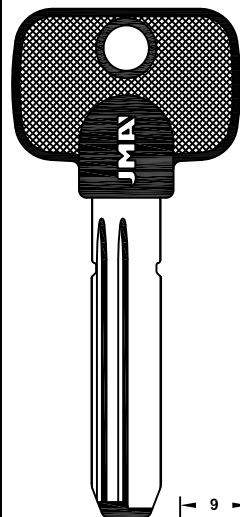
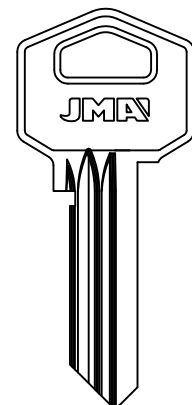



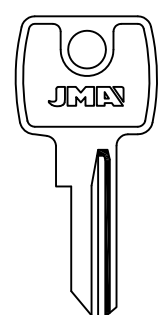
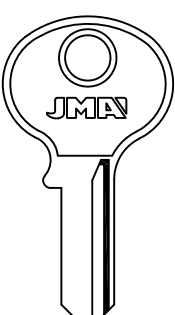
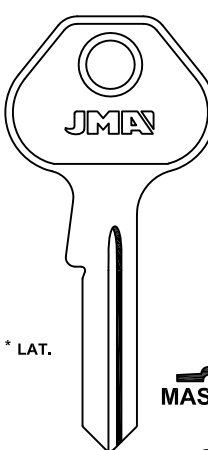
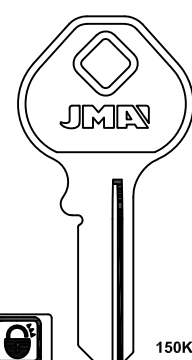

ATENCIÓN: Concerniente a las marcas y denominaciones comerciales ver nota en índice.
 ATTENTION: Concerning the marks and commercial denominations see note in index.
 ATTENTION: Concernant les marques et denominations commerciales voir la note dans l'index.
 ACHTUNG: Beziehen auf die marke und handelsname sehen sie die notiz im index.

PARA-FOR:

- LYF (E)
- MAGNUM (GB)
- MARIANI (I)
- MARQUES (P)
- MASTER (USA)

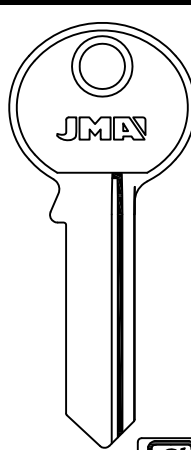
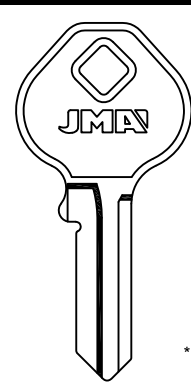
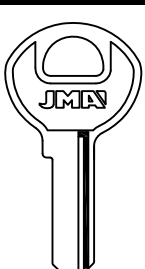
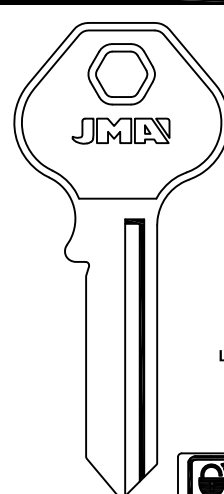
LYF		MAGNUM	MARIANI
			
LAT.	LAT.	ALP.	
			
LYF-1T	LYF-2T	MAG-2D.P	MA-5D

MARQUES	MASTER		
			
		 MAS-2D	 MAS-3D
MQ-11 MQ-1D	MAS-1 MAS-1D	7000 * MAS-24D	MAS-11 MAS-11D MAS-12D

MASTER			
			
	 * MAS-5D		
MAS-4D	MAS-6	MAS-7 MAS-7D	MAS-8



MASTER

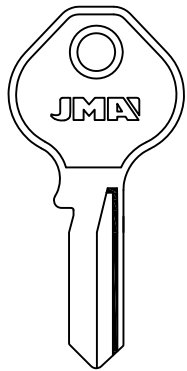

LAT.

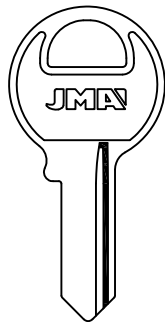

LAT.

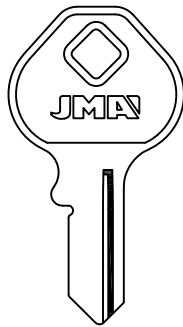

JMA



MAS-13D

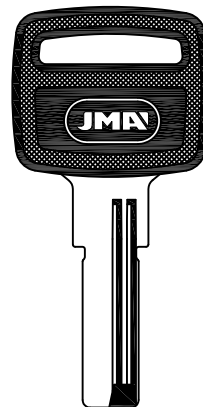

LAT.



MAS-15.P

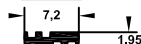

PARA-FOR:
 MASTER (USA)
 MASTER LOCK (TJ)
 MAXUS (UA)
 MCL (RUS)
 MCM (E)

MASTER

MASTER LOCK

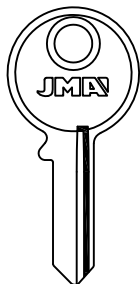

LAT.

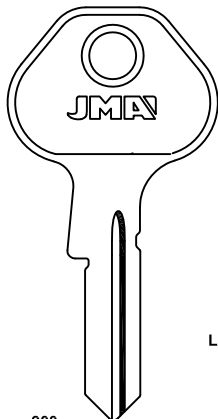

LAT.

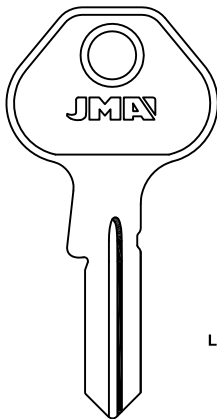

LAT.

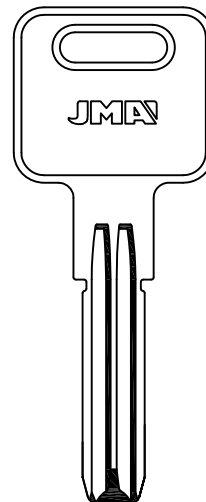

LAT.



MAXUS

MCL

MCM

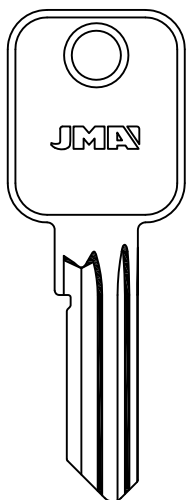

MXS-1

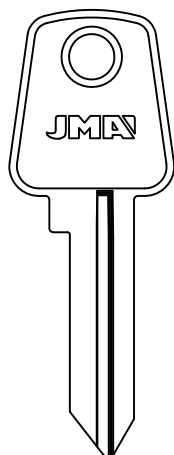

MCL-1D

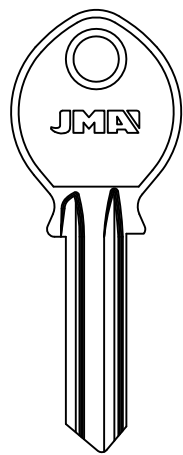

MCM-1

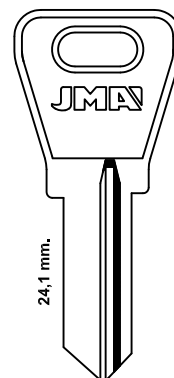

MCM-21



MCM-2D



PARA-FOR:

MCM (E)

MCM

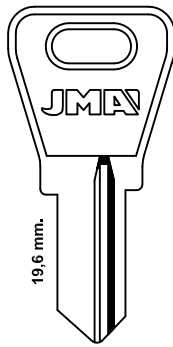

MCM-3I

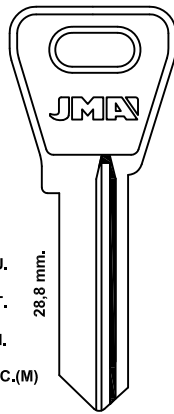

* ALU.
* LAT.
* FSH.
** MTIC.(M)

* MCM-4I

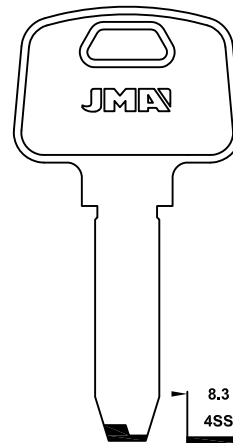

MCM-4D **

MCM-4EC

ESAFE-K+K

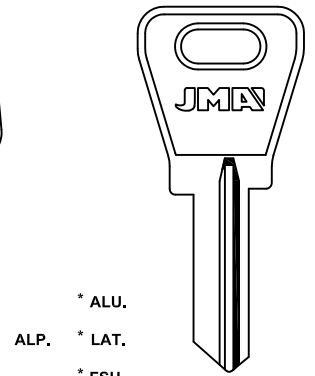

MCM-4SS

MCM-11S

LOB-YETI

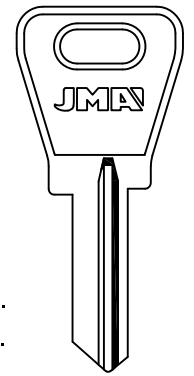

* ALU.
* LAT.
* FSH.

MCM-5I

COFER

* MCM-5D

MCM

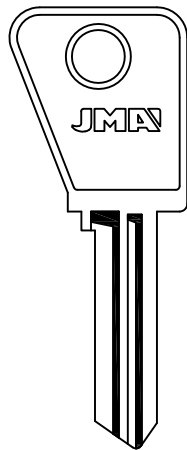

MCM-6

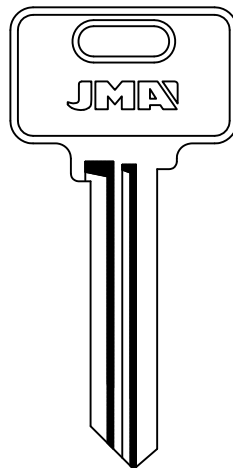

MCM-7

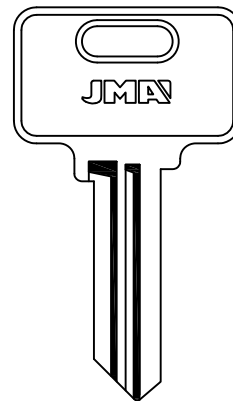

MCM-8

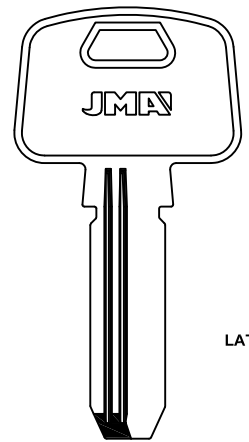

MCM-10

ESAFE-TROMER

LAT.

MCM

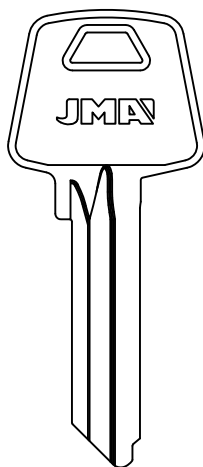

MCM-12D

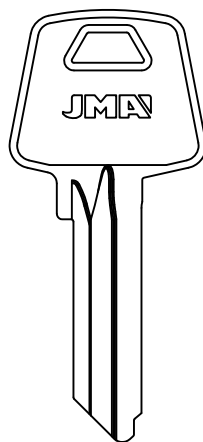

MCM-13D

ALU.
FSH.

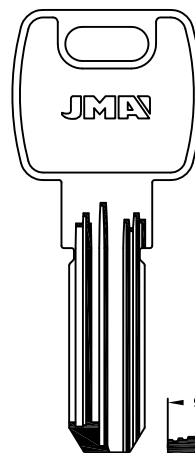

MCM-16

MCM-21D

DIERRE

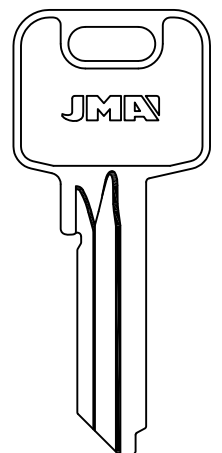

X.....1234567890
E.....11241-79868
E-1

MCM-18D



MCM

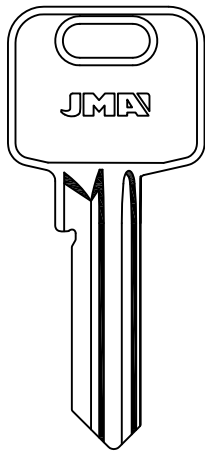

B
MCM-24B

C
MCM-24C

D
MCM-24D

E
MCM-24E

F
MCM-24F

MCM-26

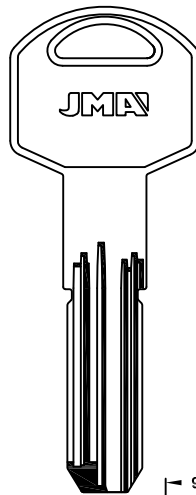

LAT.

9.7
E8
2.8
MCM-27

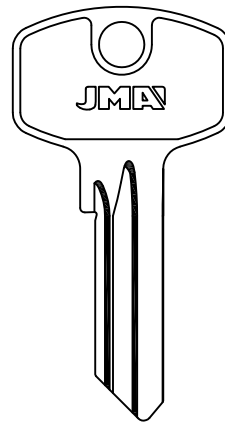

MCM-29D

PARA-FOR:

- MCM (E)
- ME-FA (RC)
- MECO (D)
- MELSMETALL (D)

MCM

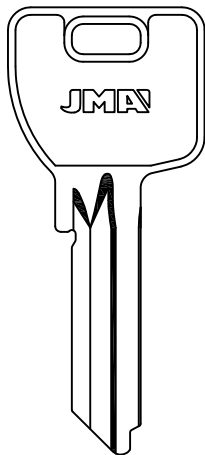

E
MCM-30D

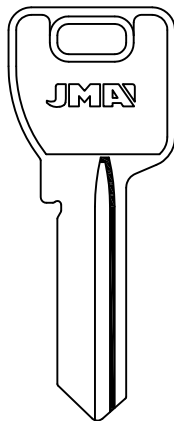

25
MCM-31

C
MCM-31D

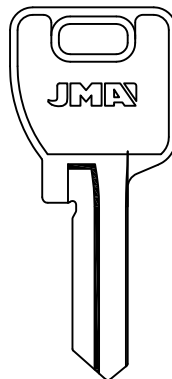

OV
MCM-32D

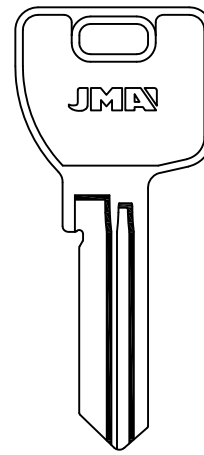

AV
MCM-33

MCM

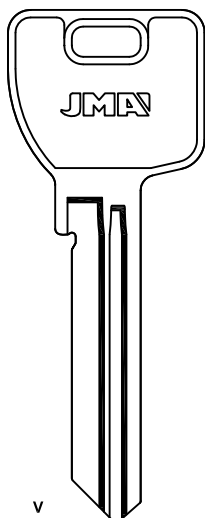

V
MCM-35

ME-FA

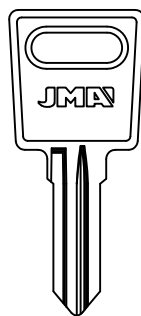

...1-100
BRA-1
BRABANTIA-CLAUSOR-CASH BOX
ELSET

MECO

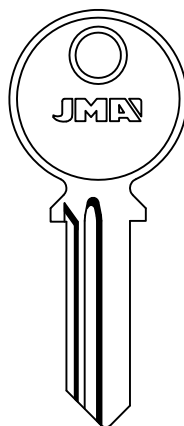

MEC-5D

MELSMETALL

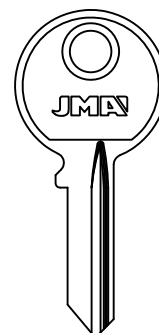

MEL-1

MEL-4

MEL-4D



PARA-FOR:
 MELSMETALL (D)
 MERONI (I)

MELSMETALL

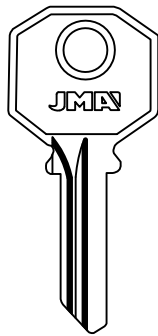

 MEL-2D

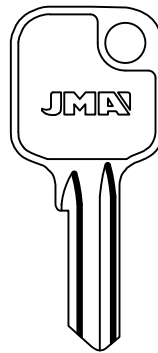



 MEL-3
 HBC



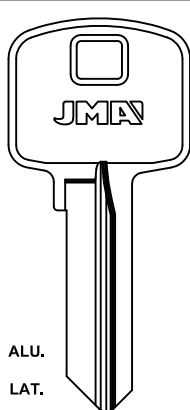

 MEL-5.P
 SECURIKEY

MERONI

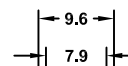
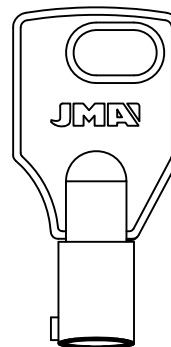
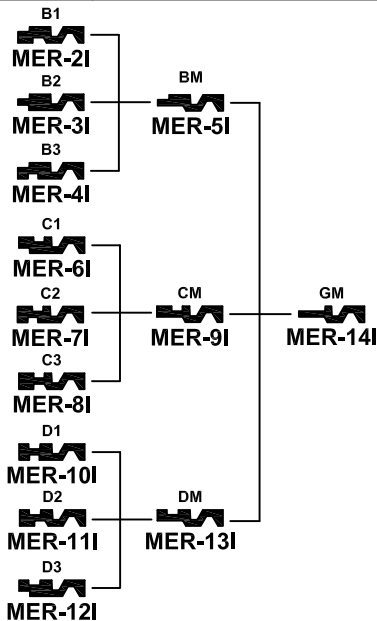
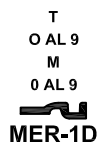

ALU.
 LAT.



MER-1T

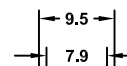
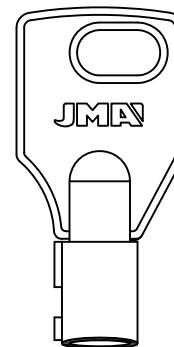

MER-3T

MERONI

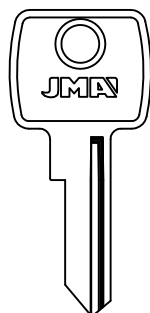

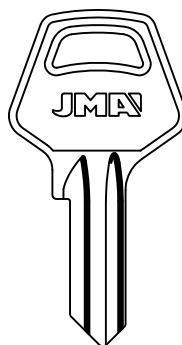

 MER-15



 MER-16
 1001-1500

 MER-16D

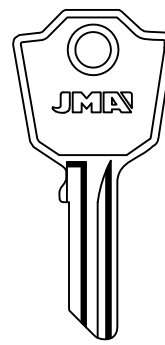
LAMA



G...3001-3480
 G...0-480
 ...3001-3480

 MER-17

LAMA

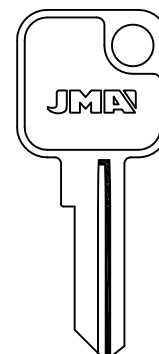

 MER-18

PREMI-APRI

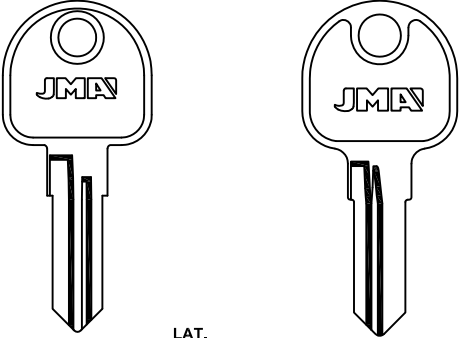
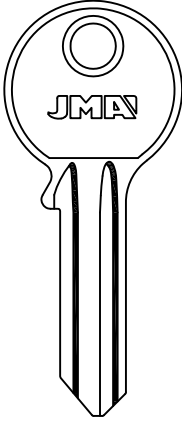
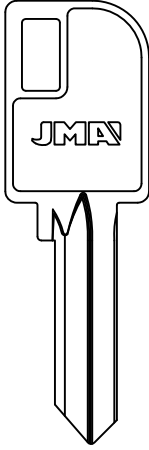
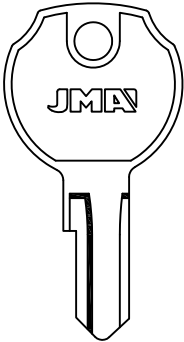
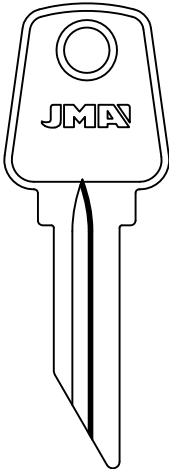
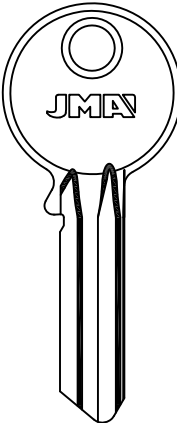
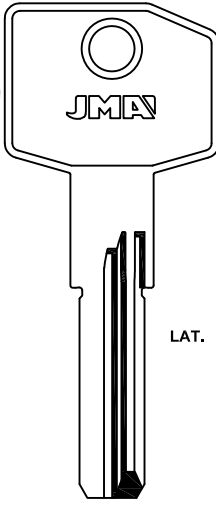
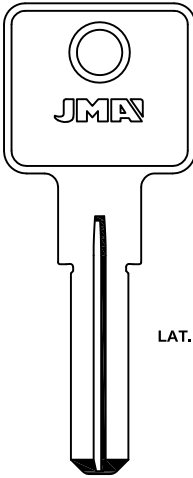
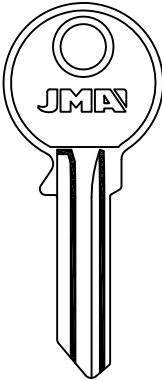
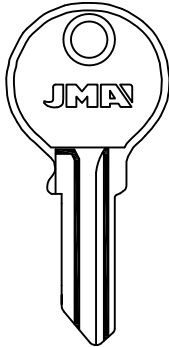
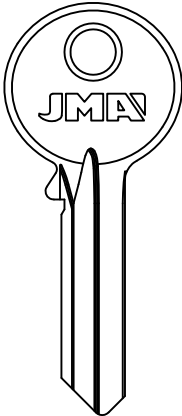
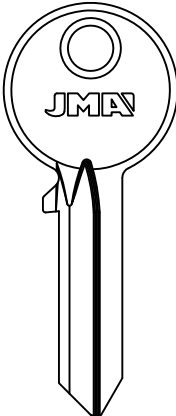

MERONI		METAL	METALUX	
 <p>LAT.</p> <p>CC MER-20D</p> <p>CD MER-21D</p> <p>MER-19D</p>		 <p>MTL-1 MTL-1D</p>	 <p>MET-2D</p> <p>CAS-CISMA</p>	
METEOR	METIZ	MG (MONTI)		
 <p>B...1-600 G...1-600</p> <p>MTO-1</p>	 <p>MEZ-1D</p>	 <p>MGA-1 MGA-1D</p>	 <p>LAT.</p> <p>MGA-2</p> <p>TROMER</p>	 <p>LAT.</p> <p>MGA-3</p>
MICHEL-SEAT		MILA		
	 <p>LAT.</p>			
<p>MCH-1 MCH-1D MCH-2 MCH-2D</p> <p>OMR-POTENT AM-POTENT</p>		<p>MI-1D</p>	<p>MI-2D</p>	





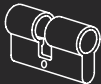





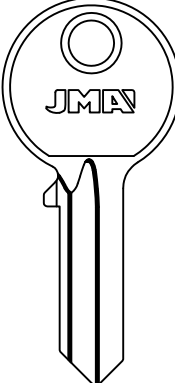
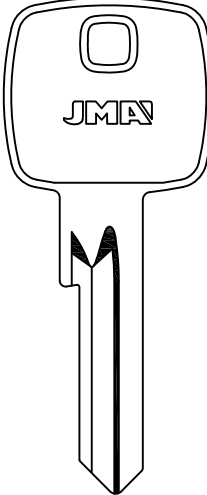
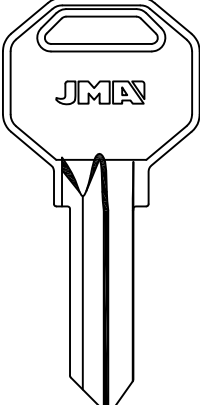
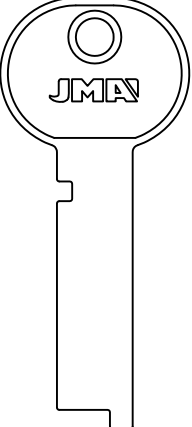

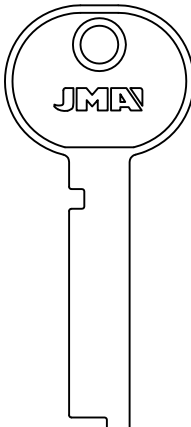
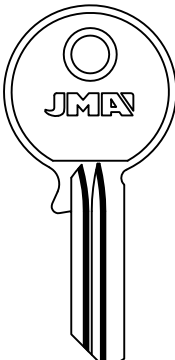
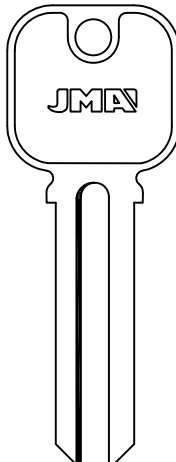
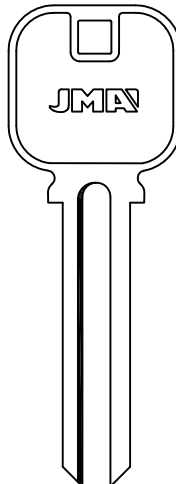

PARA-FOR:

- MERONI (I)
- METAL (BG)
- METALUX (F)
- METEOR (D)
- METIZ (RUS)
- MG MONTI (I)
- MICHEL-SEAT (I)
- MILA (DK)

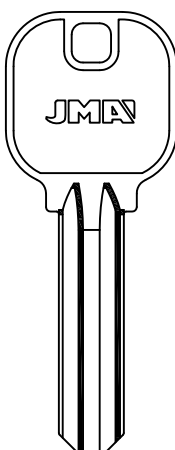
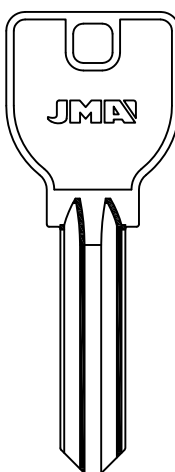
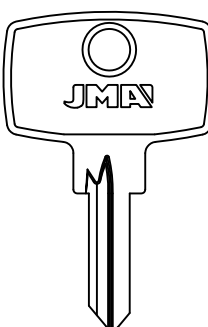
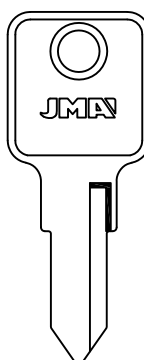

PARA-FOR:

- MILA (DK)
- MILES (RUS)
- MING-TAY (RC)
- MIWA (J)
- MLM (F)

MILA		MILES	
			
 MI-3D	 MI-4D	 MI-5D TRINITY	 MIL-1
MILES	MING-TAY	MIWA	
			
 MIL-2	 MIN-1D	 MIW-1	 MIW-2
MIWA		MLM	
			
1-2-3-4 1-2-3-4-5  MIW-3	1-2-3-4 1-2-3-4-5  MIW-4	 MLM-1D	 MLM-2  MLM-5  MLM-5D
		DOM-STUV	DOM-STUV

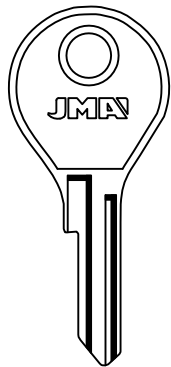

MLM**MLM-3**

DOM-STUV

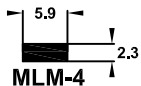
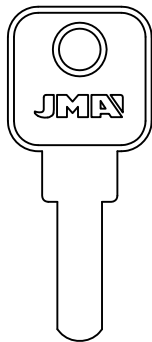
**MLM-4**

LAT.

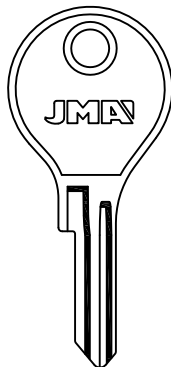
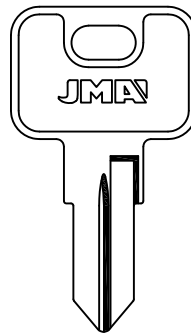
**MLM-6****MLM-7****MOBELLA****MBL-1****MBL-1D****PARA-FOR:**

MLM (F)

MOBELLA (S)

MOGILEV (RUS)

MON (E)

MONOBLOC (F)

MOSRENTGUEN (RUS)

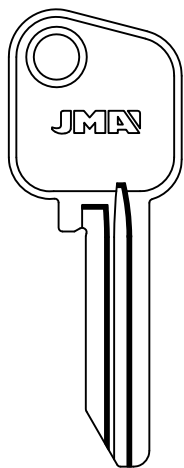
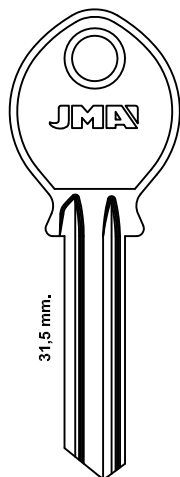
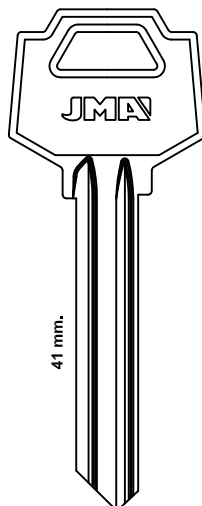
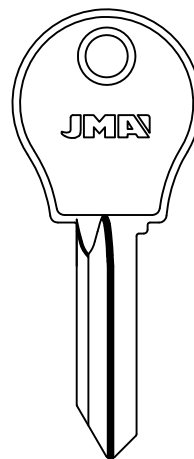
MOGILEV**MOG-1D****MON****MON-1I****MON-1D****MON-2I****MON-2D****MONOBLOC****MNO-1D**

FO

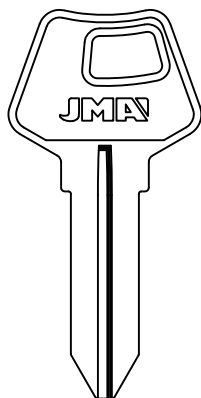
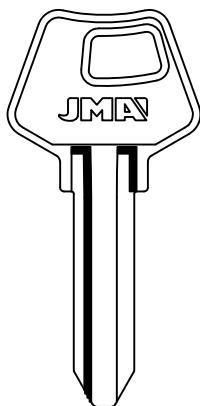
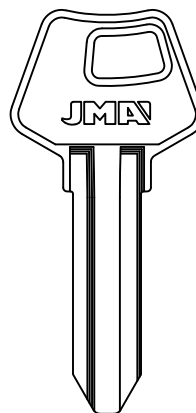
MOSRENTGUEN**MR-1****MR-2****MR-3**

PARA-FOR:

- MOTTURA (I)
- M.P. PLODARI (I)
- MSM
- MSV (P)
- MUL.T.LOCK (IL)

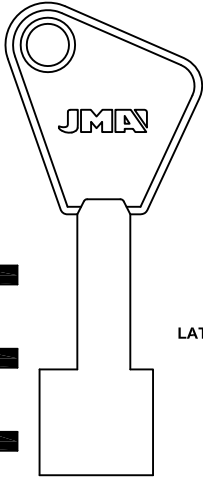
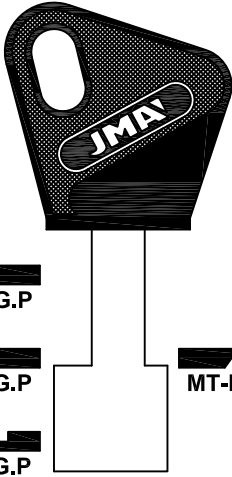
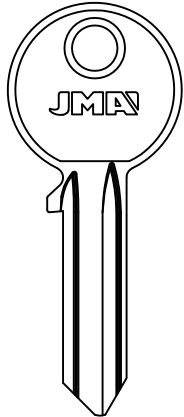
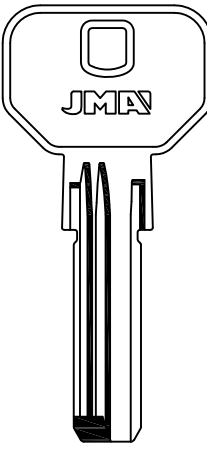
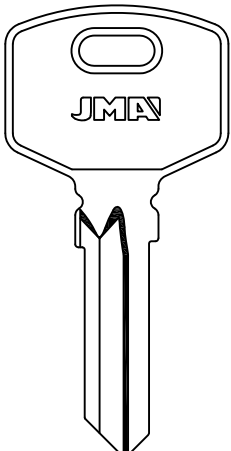
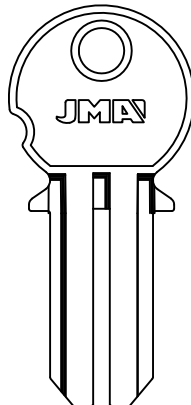
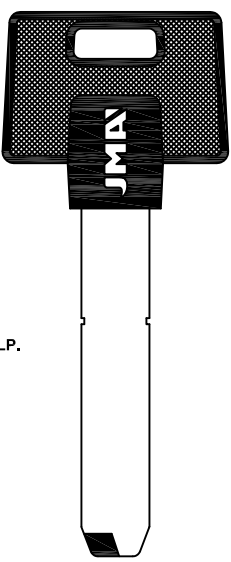
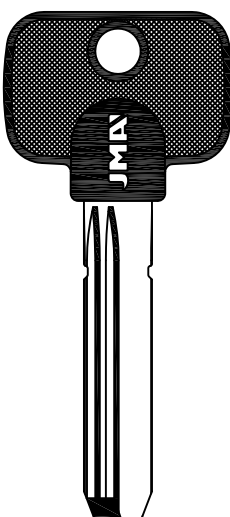
MOTTURA		M.P. PLODARI
 <p>LAT.</p> <p>MT-AG</p> <p>MT-CG</p> <p>MT-EG</p> <p>MT-GG</p>	 <p>LAT.</p> <p>MT-AG.P</p> <p>MT-CG.P</p> <p>MT-EG.P</p> <p>MT-DG.P</p> <p>MT-GG.P</p>	 <p>MP-1I</p> <p>MP-1D</p>
MSM		MSV
 <p>MSM-1D</p> <p>8.7</p> <p>2.3</p>	 <p>MSM-2D</p>	 <p>MSV-1</p> <p>MSV-2</p>
MUL.T.LOCK		
 <p>ALP.</p> <p>GAMMA</p>	 <p>ALP.</p> <p>GAMMA</p> <p>MUL-T2.P</p> <p>MUL-T3.P</p> <p>MUL-T4.P</p> <p>MUL-T5.P</p> <p>MUL-T7.P</p> <p>MUL-T3.P1</p> <p>64</p> <p>MUL-T8.P1</p> <p>MUL-T9.P1</p> <p>JUNIOR</p> <p>MUL-T11.P1</p>	



MUL.T.LOCK

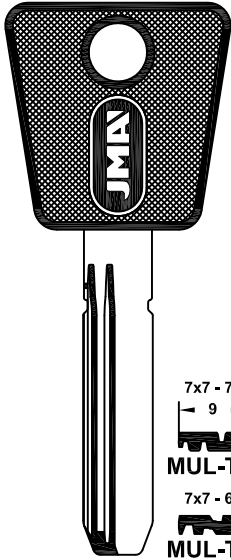
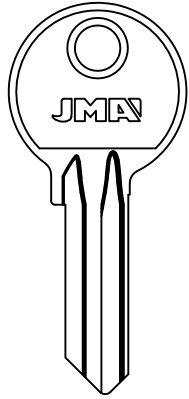

ALP.

MUL-T6 MUL-T6D

MUL-T10.P
MUL-T16.P

NATIONAL CABINET

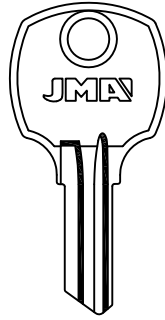

LAT.

NTC-6

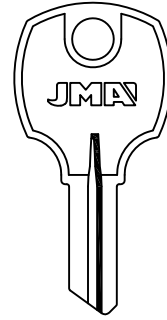

LAT.

NTC-10D

PARA-FOR:

- MUL.T.LOCK (IL)
- NATIONAL CABINET (USA)
- NOVA (D)
- OCARIZ (E)
- OCTAVO M. (RUS)
- OFITA (E)
- OJMAR (E)

NOVA

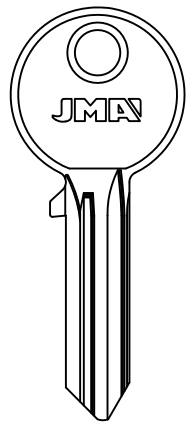

NO-1

ABUS-TOP

OCARIZ

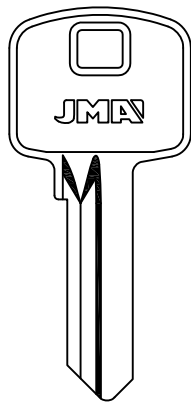

KL
OCA-1D
KR
OCA-2D

OCTAVO M.

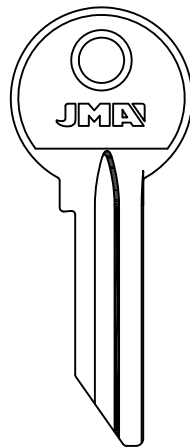

8M-1D

OFITA

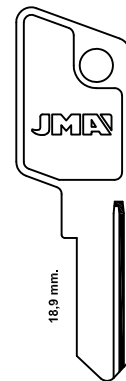

OF-1

OFITA

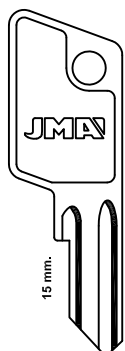

OF-2

OJMAR

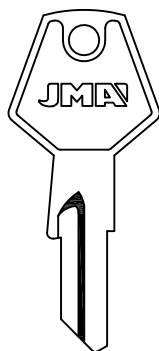

OJ-1D

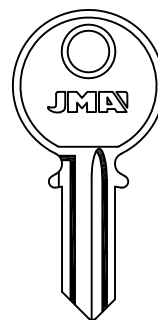

OJ-2I

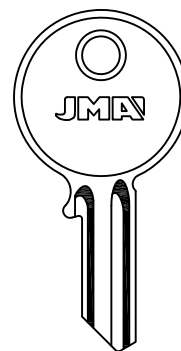

OJ-3I OJ-3D

OJ-7I



PARA-FOR:

OJMAR (E)

OLIVA (I)

OJMAR

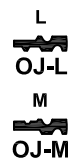
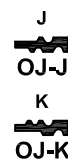
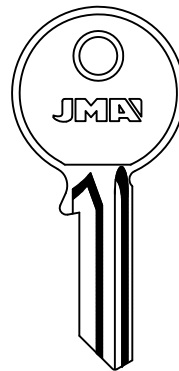
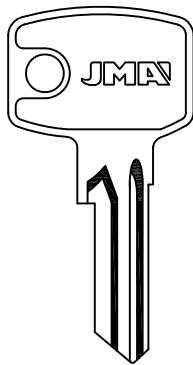
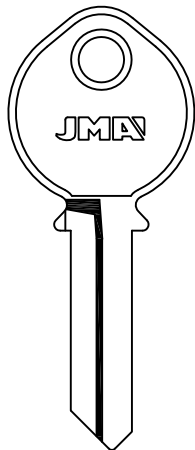

OJMAR

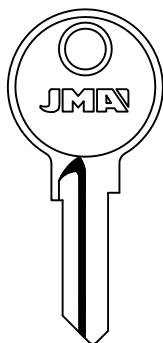

HERO-KEMEN-RS

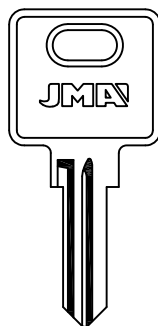

BURG-HRG-ISKU-KEMEN-MOFLEX-SISO-STUMPF METALL

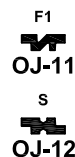
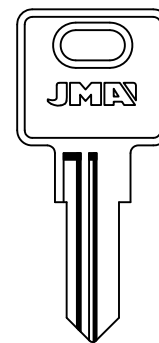

BURG

OJMAR

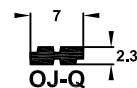
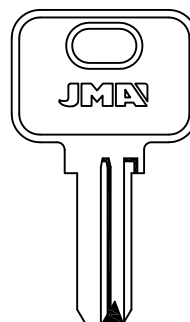
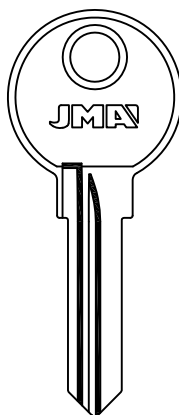
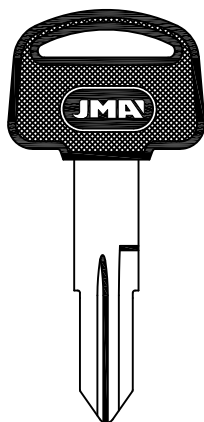

ALP.

OLIVA

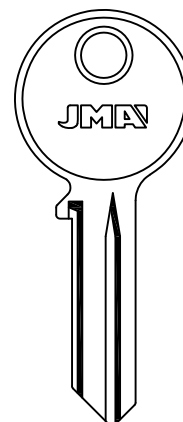



FERMABLOCK-PB-PREFER

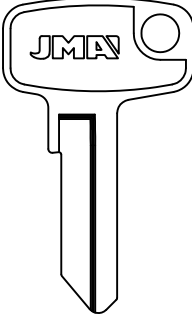
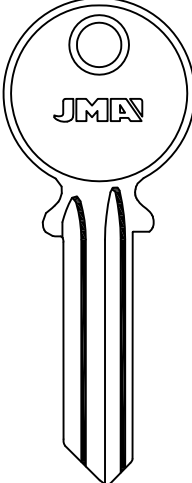
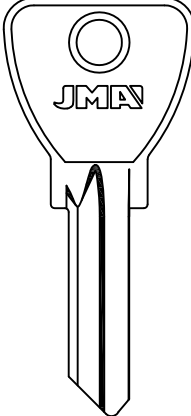
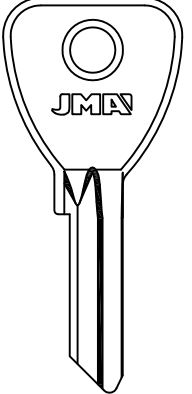

OLIVETTI	OMA	O MEC	
 <p data-bbox="159 638 239 683">OLIV-1</p>	 <p data-bbox="462 638 542 683">OA-1</p> <p data-bbox="470 694 534 716">C.A.R.S.</p>	 <p data-bbox="829 638 909 683">OMC-1D</p>	 <p data-bbox="1133 638 1212 683">OMC-2D</p>

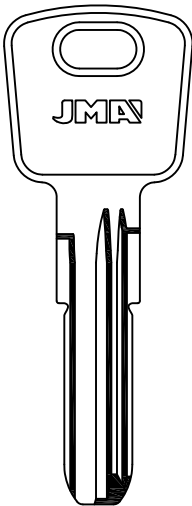
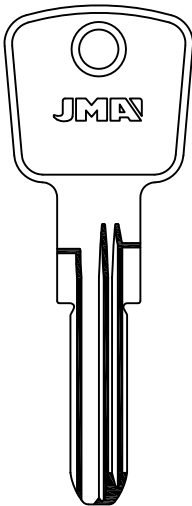
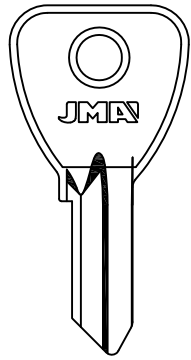
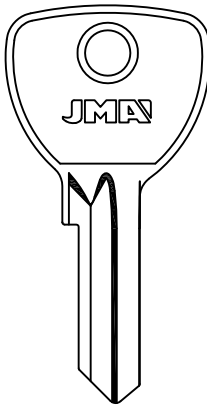
PARA-FOR:
 OLIVETTI (I)
 OMA (I)
 OMEC (I)
 OMIV (I)
 O.M.R. (I)
 ORDO (F)
 ORION-NOVOX (F)

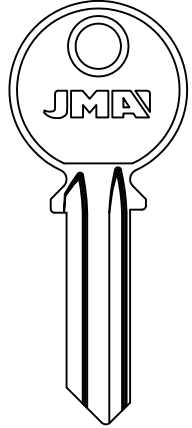
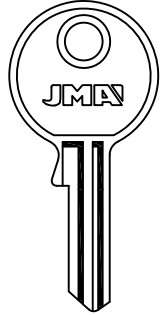

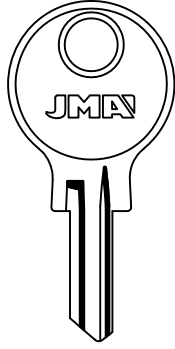
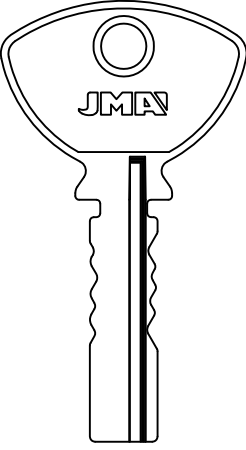

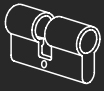





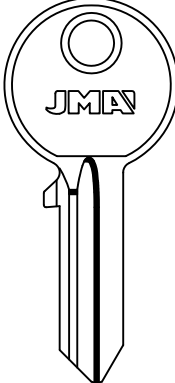
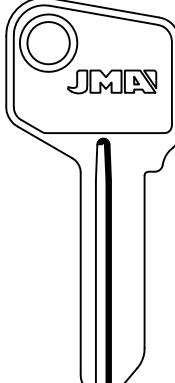
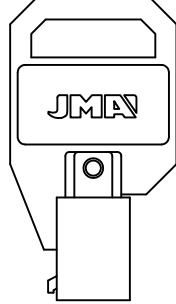
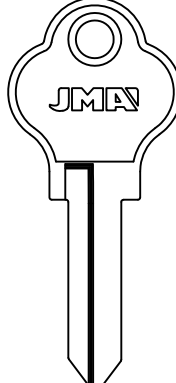

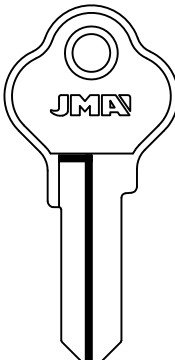
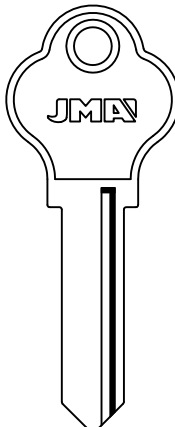
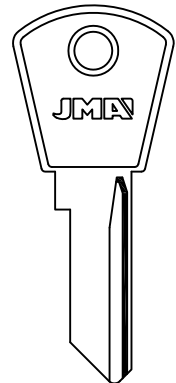
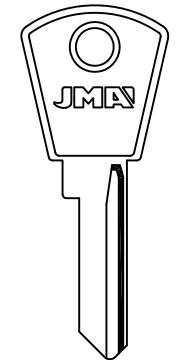

O MEC			
 <p data-bbox="295 1120 335 1142">LAT.</p> <p data-bbox="159 1332 239 1377">OMC-3</p> <p data-bbox="167 1377 231 1400">SANTOS</p>	 <p data-bbox="598 1120 638 1142">LAT.</p> <p data-bbox="462 1332 542 1377">OMC-4</p>	 <p data-bbox="829 1332 909 1377">OMC-5D</p>	 <p data-bbox="1133 1332 1212 1377">OMC-6D</p>

OMIV	O.M.R.	ORDO	ORION-NOVOX
 <p data-bbox="95 1993 167 2038">OMI-1</p> <p data-bbox="223 1993 311 2038">OMI-1D</p> <p data-bbox="167 2049 231 2072">CIB-STV</p>	  <p data-bbox="470 1993 534 2038">OM-1</p> <p data-bbox="446 2049 558 2072">MICHEL SEAT</p>	 <p data-bbox="710 1993 774 2038">OR-1I</p>	 <p data-bbox="1005 1993 1077 2038">ON-1I</p> <p data-bbox="1141 1993 1212 2038">ON-1D</p> <p data-bbox="1061 2049 1157 2072">DECAEUX</p>

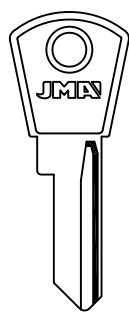
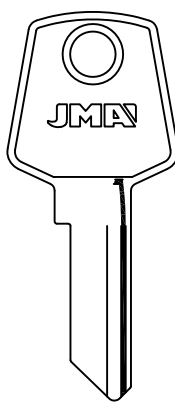
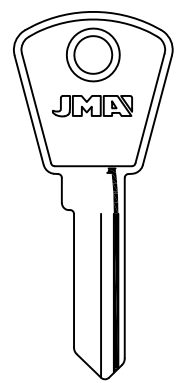
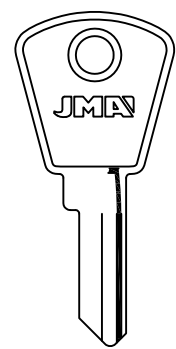

PARA-FOR:

- ORO (IL)
- ORSHA (RUS)
- P&C I. (USA)
- PADO (BR)
- PAPAIZ (BR)

ORO	ORSHA	P&C I.	PADO
			
 ORO-1D	 ORK-1D	 PCI-1T	 PAD-1D
PADO		PAPAIZ	
			
 PAD-2D	 PAD-3	 PAD-3D	 45-50-60-70 PAP-1
		 35 PAP-2	
PAPAIZ			
			
 25-30 PAP-3	 45-50-60-70 PAP-4	 PAP-5	 PAP-6



P.C.

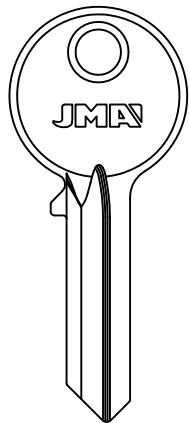

1 AL 5
PC-1D

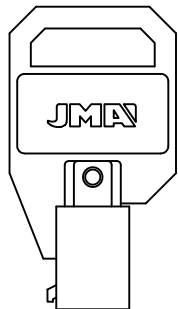

8,04 9,6
PC-1T

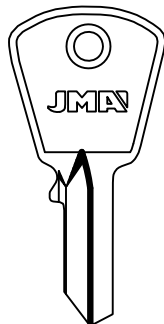

...1 AL 5
PC-2D

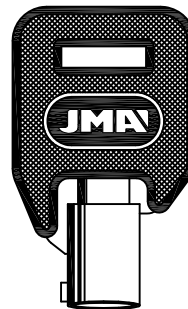

8,04 9,6
PC-3T.P

ETNA-FEB-FPB-FRAL-SANTOS

PARA-FOR:

P.C. (I)

PENZMASH
(RUS)

PETROZAVODSK
(RUS)

PFAFFENHAIN
(D)

PENZMASH

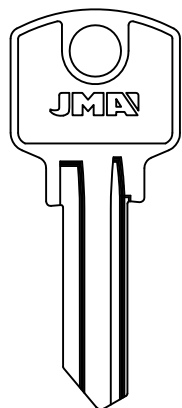

PEN-1 PEN-1D

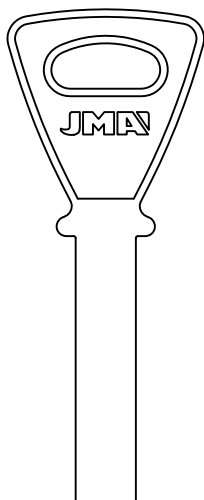

PEN-2

PETROZAVODSK

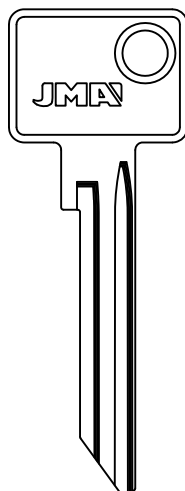

PET-1

PFAFFENHAIN

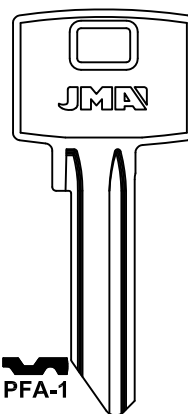

PFA-1
KH
PFA-2
PFA-5

PFAFFENHAIN

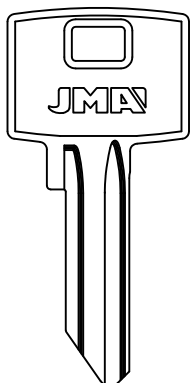

L
PFA-3

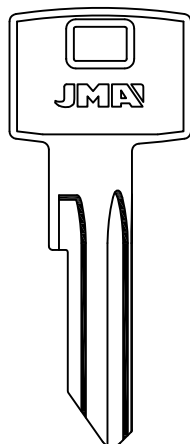

PFA-4

A21
PFA-10D
A22
PFA-11D
A23
PFA-12D

EA
PFA-13D
EB
PFA-14D
EH
PFA-15D
EN
PFA-16D
RF
PFA-17D
RG
PFA-18D

T21 AL T26-T28
T31 AL T42
T44 AL T46
T51-T54-T65
T85-T86-T91
PFA-22 PFA-22D



PARA-FOR:

PFAFFENHAIN
(D)

PHILLIPS (MEX)











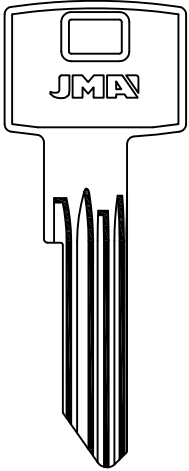
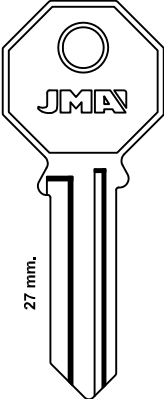
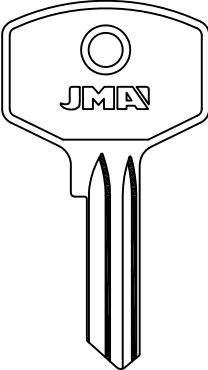







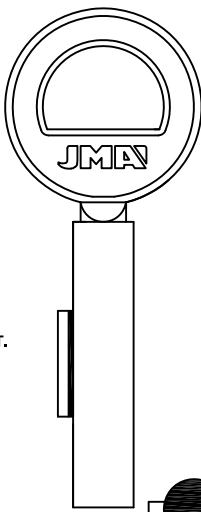
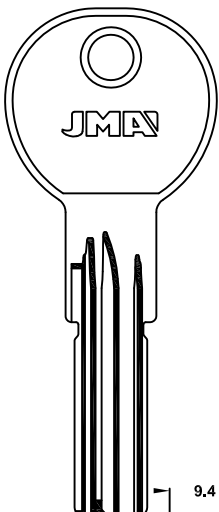
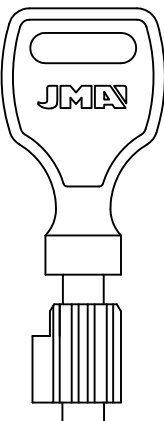
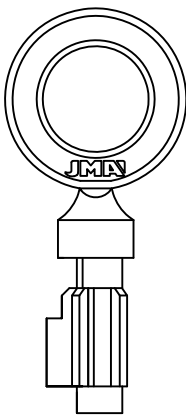

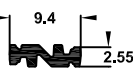

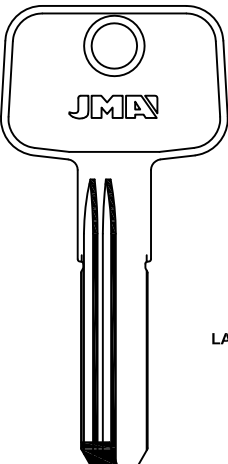
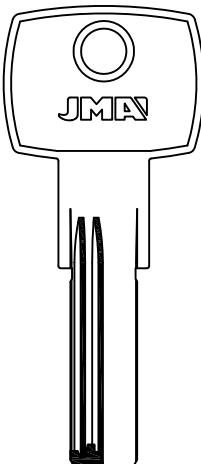
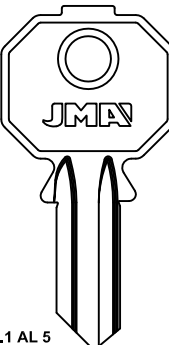
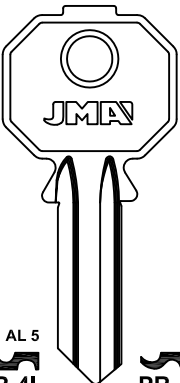

PHOENIX (GB)

PICARD (F)

POLLUX (F)

POTENT (I)

PREFER (I)

PFAFFENHAIN		PHILLIPS	PHOENIX	
		 <p>27 mm.</p>		
 PFA-6  PFA-6D  PFA-21		 PHI-52	 PHO-1	
			 A21 PFA-7D  A22 PFA-8D  A23 PFA-9D	
PICARD		POLLUX		
 <p>LAT.</p>  <p>LAT.</p>		 <p>LAT.</p>  <p>LAT.</p>		
 PIC-1E  PIC-8D <p>9.4 2.55</p> <p>ISEO</p>		 POL-3TEC  POL-5TEC  POL-4E		
POTENT		PREFER		
 <p>LAT.</p> 		 <p>...1 AL 5</p>  <p>...1 AL 5</p>		
 PTN-1D <p>8.6 2.4</p>		 PR-1  PR-1D  PR-4I  PR-4D  PR-2  PR-10  PR-3  PR-11 UNIFOR BLOCUS-CAP-CIB-JIP PASTORE-PROMO		
 PTN-2D <p>P04..... 1-2-3-4-5-6</p>				



PREFER

PARA-FOR:

PREFER (I)

REGAL (GB)

RENZ (D)

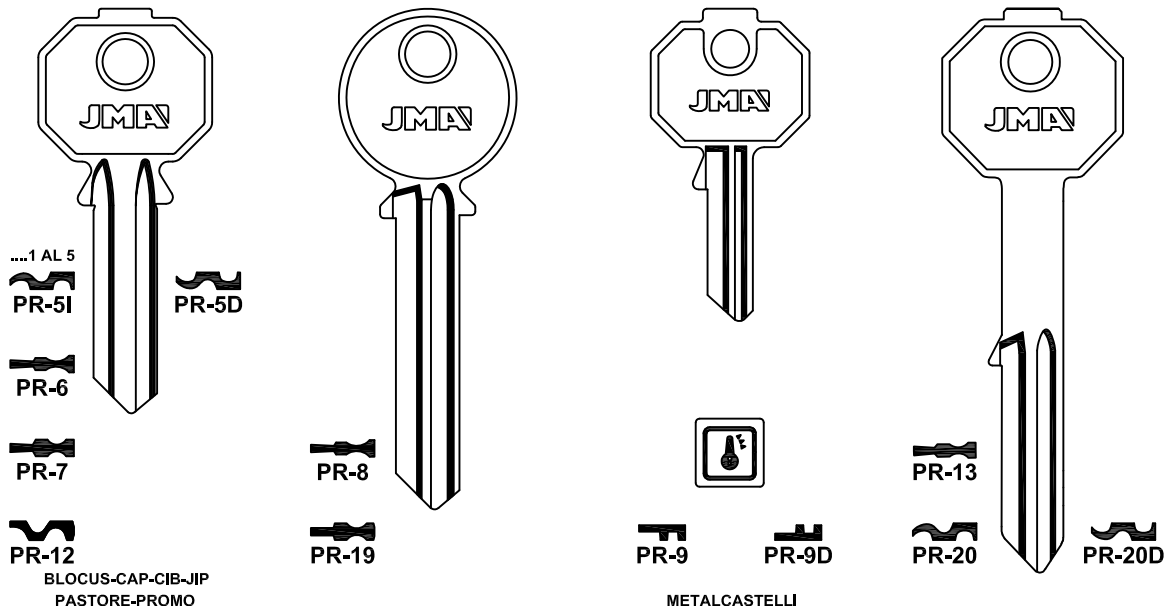

PREFER

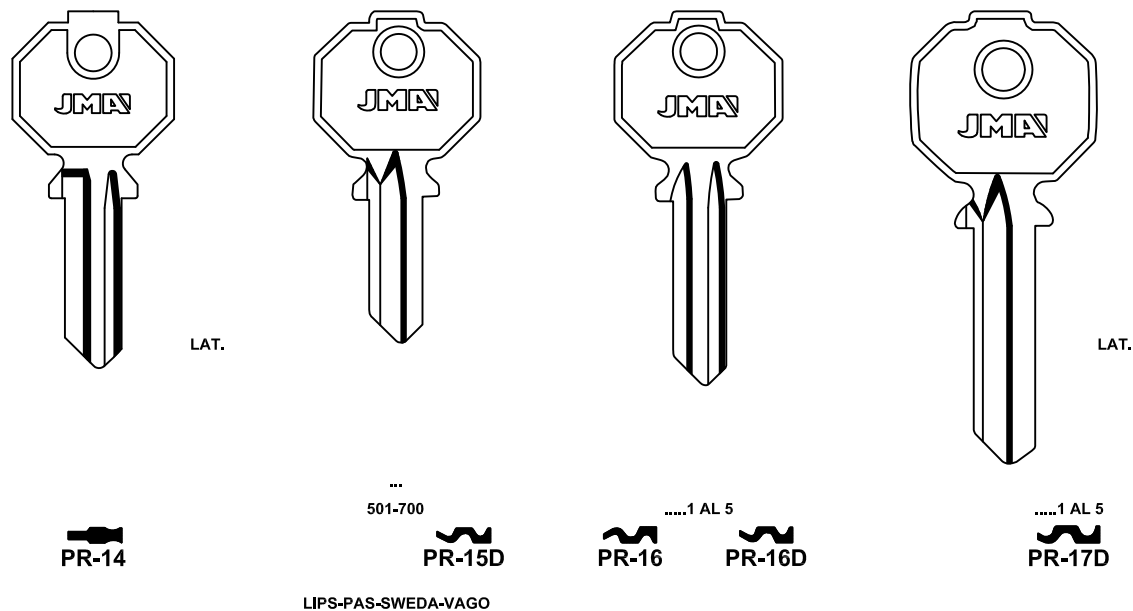

PREFER





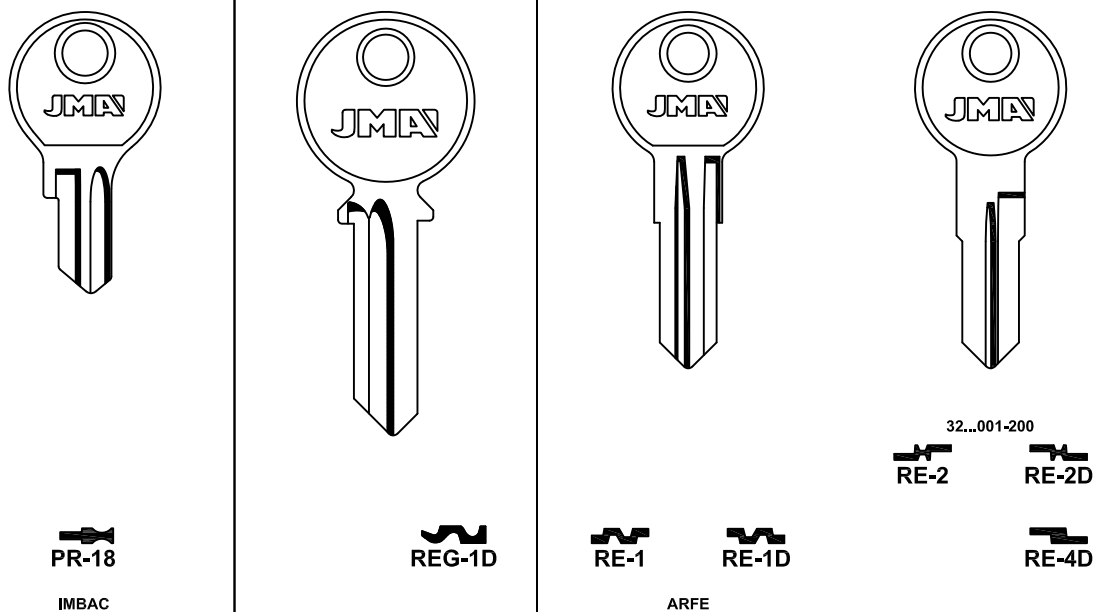





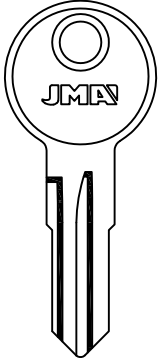
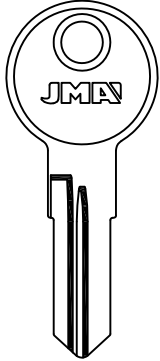
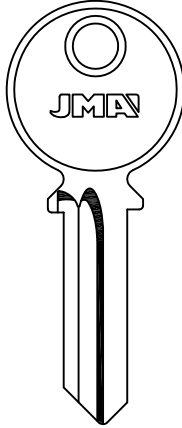
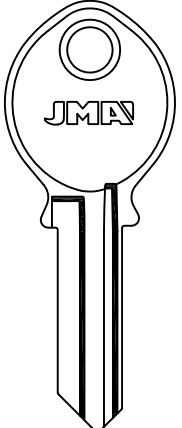





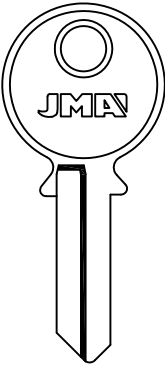
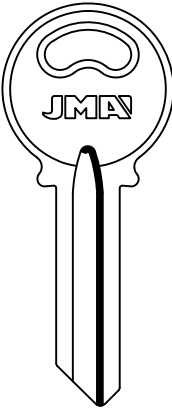
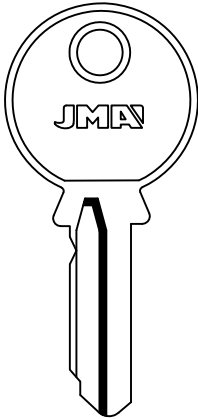
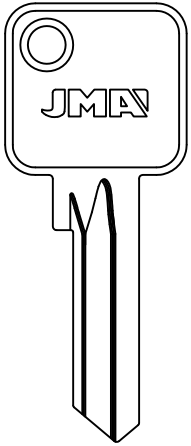

REGAL

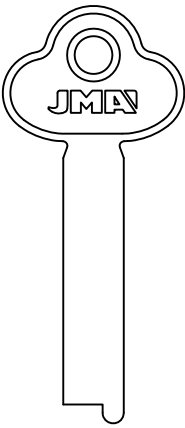
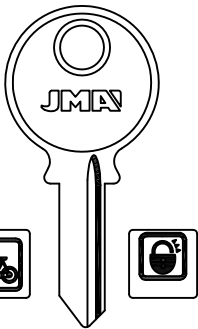
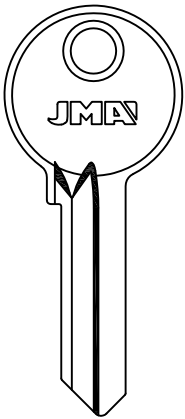
RENZ



PARA-FOR:

- RENZ (D)
- REX (DK)
- RGM (E)
- RIAZIAN (RUS)
- RICOUARD (F)
- RIGA (RUS)
- RIL (E)
- RIPA (E)
- RITA

RENZ		REX	RGM	
				
				
RGM		RIAZIAN	RICOUARD	RIGA
				
		 COUILLET-DECAYEUX-KIFERM LAS-PASSY-YVEL		
RIL	RIPA		RITA	
				
				
				
				
	ABUS-FADE			



RONIS

PARA-FOR:

RONIS (F)

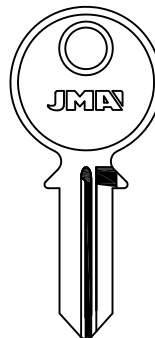
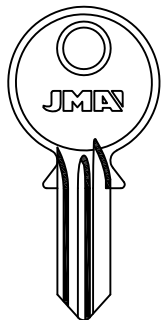

A8..AA-DS
..8AB-ZZ
S...385-402



A9..AA-DS
..8AB-ZZ
S...403-420



..4AB-ZZ
S...331-348



RO-2I

..3AB-ZZ
....1 AL 4



RO-2D

AA-JZ
A4../A.4.



RO-4I

AA-JZ
A3../A.3.
S...213-246



RO-4D

AB-ZZ
..6
S...349-366



RO-6I

AB-ZZ
..7
S...367-384



RO-6D



C4..AA-ZY
D4..AA-HR



RO-5I

C3..AA-ZY
D3..AA-HR
J...1-544



RO-5D

ABSA-FROSER-PJ-SADV

ABSA

RONIS

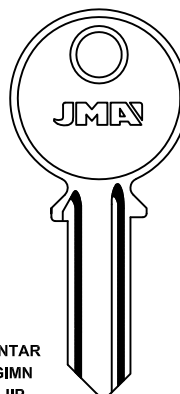
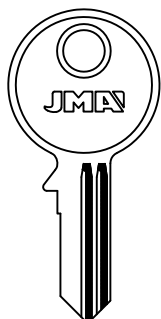

ARMOR
EMHART
FORINDEX
KARDEX
MLM
NEMEF
RONEO
SANEL STRAFOR
SCHAFFER
YAC

...151-700
E...1-1000
T...107-400
Y...101-600



RO-7I

...11 1-700
A...A1-700
C...101-600
D...1-1000
T...1-380



RO-7D

...151-700
E...1-1000
T...107-400
Y...101-600



RO-8I

T...1-380
TA...1-224
GV...1-300
...F1-500
1F..1-21



RO-8D

F...1-500



RO-30

TA...1-224
GV...1-300
...F1-500
1F..1-21



RO-30D

...151-700
E...1-1000
T...107-400
Y...101-600



RO-32D

...1-380
TA...1-224
GV...1-300
...F1-500
1F..1-21



RO-33

ANTAR
GIMN
JIP
LAPERCHE
PM
SESA



RO-9I

...0 AL 8



RO-9D

RONIS

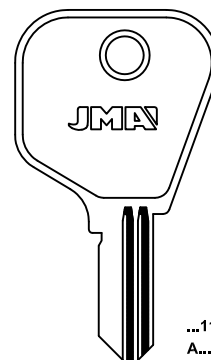
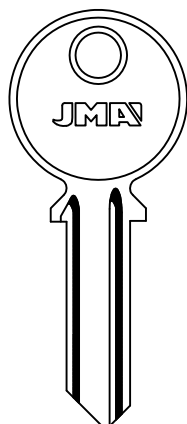

FM
RO-18I
LIONA LIOX-LAPERCHE



RO-19I



RO-19D

FK
RO-20I
FONTAINE-LAPERCHE



RO-21I



RO-20D

ET
RO-21I
RO-21D



RO-22I



RO-21D

RO-22I
RO-23D



RO-23D

RO-10D

ANTAR
BLOCUS
BAB
DEBEAURAIN
DELTA
DERLOCHE
DESPREZ
DC
EMGE
EQUIBATIR
FONTAINE
FORINDEX
GOLLOT
GUIDOTTI
JIP
LAPERCHE
LIONA-LIOX
MAFOR
MONDIAL
MOREAUX
NUMIDIA
PM
SESA
STREMLER
STUV
VEGA

...151-700
E...1-1000
T...107-400
Y...101-600



RO-11I

...11 1-700
A...A1-700
C...101-600
D...1-1000
T...1-380
TA...1-224
GV...1-300
...F1-500
1F..1-21



RO-11D

ABSA-SADV-SIMPLEX



PARA-FOR:

- RONIS (F)
- ROSSETTI (I)
- ROYAL (RC)
- RUKO (DK)

RONIS

RO-12I RO-12D
M...601-983 TAV

RO-16I RO-16D

RO-24I RO-24D

RO-25I RO-25D
FM
LAPERCHE

RO-26I RO-26D
FL
LAPERCHE

RO-27I RO-27D
FK
LAPERCHE

RO-28I RO-28D

RO-29D

RO-31D

BURG-STRAFOR ANTAR-LAPERCHE-SESA SOLOR

.....1-1296
.....0 AL 9 AL 0
.....1 AL 9

RONIS

RO-34D RO-36D

RO-37 RO-37D

RO-38 RO-38D

RO-39 RO-40 RO-40D

RO-41 RO-42

CATOR JD

ROSSETTI

ROYAL

RUKO

ROSE-1 ROY-1 RU-1D

LAT. * LAT.

ALU. DIFA

RU-2I RU-2D

RU-3D

RU-4D

RU-10D

* RU-19D

RU-TL

.....1 AL 8
.....1 AL 9
.....1 AL 9 AL 0 A-B
.....0 AL 9 A AL M
S.....1 AL 9



RUKO

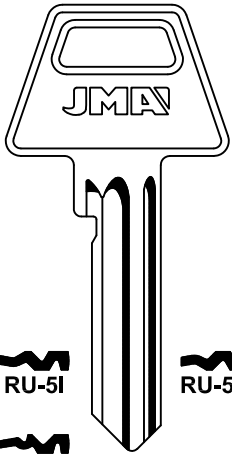

SKB
RU-11D

RU-12D

RU-14D

RU-15

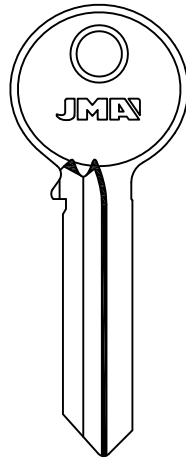

.....
1 AL 9 A AL C
RU-8D

GK
RU-GK7

GL
RU-GL7

GM
RU-GM7

GS
RU-GS7

RU-5I

RU-5D

RU-K

RU-KD

RU-6I

RU-L

RU-9I

RU-9D

RU-M

RU-7D

ASSA

RUKO

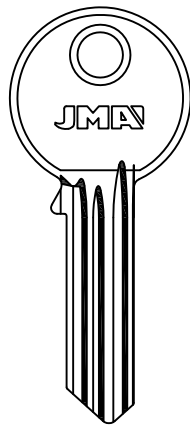
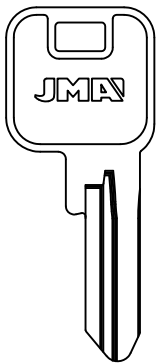

GK
RU-GK
GL
RU-GL

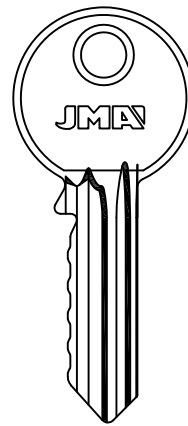

GS
RU-GS

RU-13D

GC
RU-GC

HNR
RU-16D

GM
RU-GM

ASSA

RUSSIA

RUSSWIN

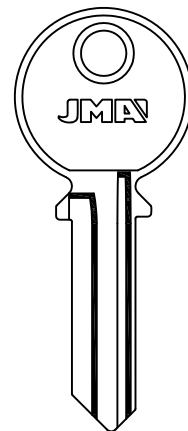
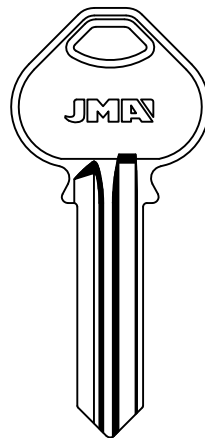
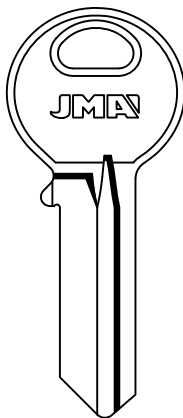
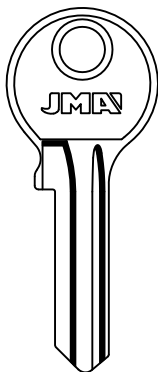

LAT.

RSS-1

RSS-2D

RUS-1

RUS-2

JMA[®]







Copyright by Alejandro Altuna S.A. 2014



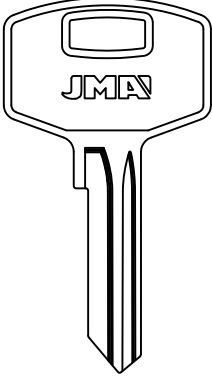
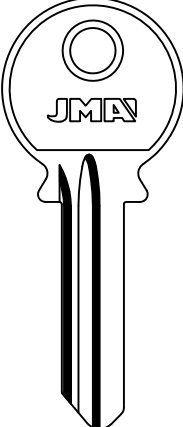
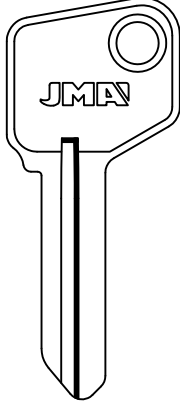
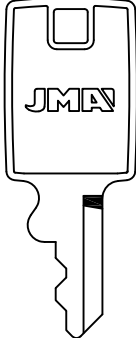





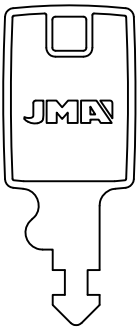
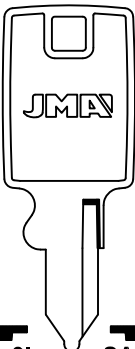
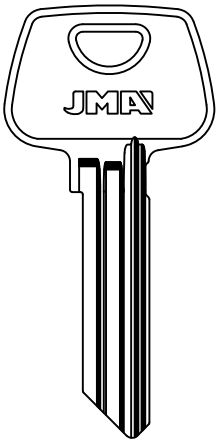
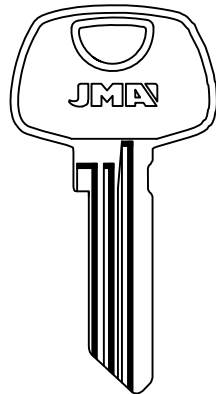

ATENCIÓN: Concerniente a las marcas y denominaciones comerciales ver nota en índice.
ATTENTION: Concerning the marks and commercial denominations see note in index.
ATTENTION: Concernant les marques et dénominations commerciales voir la note dans l'index.
ACHTUNG: Beziehen auf die marke und handelsname sehen sie die notiz im index.





PARA-FOR:

- SABT (KW)
- SAM (RUS)
- SAMSONITE (USA)
- SARGENT (USA)

SABT	SAM		SAMSONITE
			
 SABT-1	 SAM-1D	 SAM-2D	170 S  SA-1  SA-1D

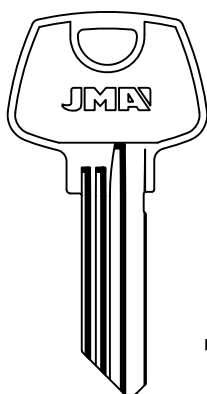
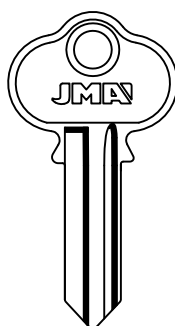
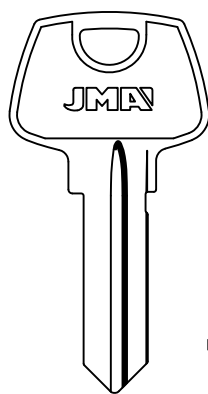
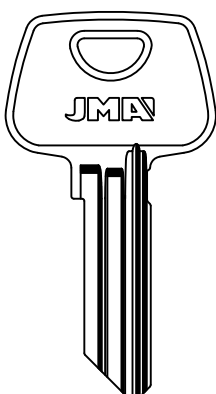
SAMSONITE		SARGENT	
			
 SA-2	 SA-3I  SA-3D SE 041 SE 052 SE 083 SE 124 SE 165 SE 186  SA-4	LN RN  SAR-1  SAR-1D	S  SAR-2D

BRICARD-SHOWA

SARGENT					
					
LAT.	LAT.	LAT.	LAT.	LN RN  SAR-6	LN RN  SAR-6D



SATURN

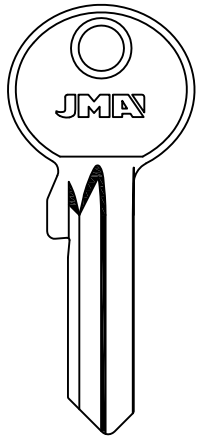

SAT-1D

GERA-VERA

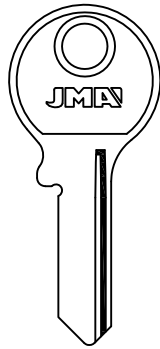

SAT-2

SCHÄRER

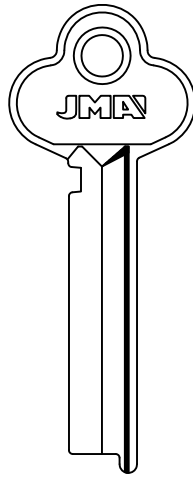

SHR-1

LAT.

SCHLAGE

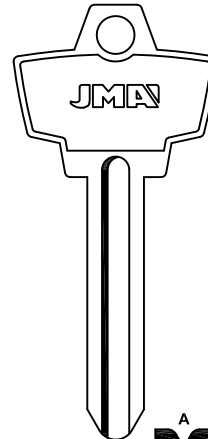

A
SLG-1

W
SLG-2

EPO

PARA-FOR:

- SATURN (D)
- SCHÄRER (USA)
- SCHLAGE (USA)
- SCHLECHTENDAHL (D)
- SCHUCO (D)
- SEA (CH)

SCHLAGE

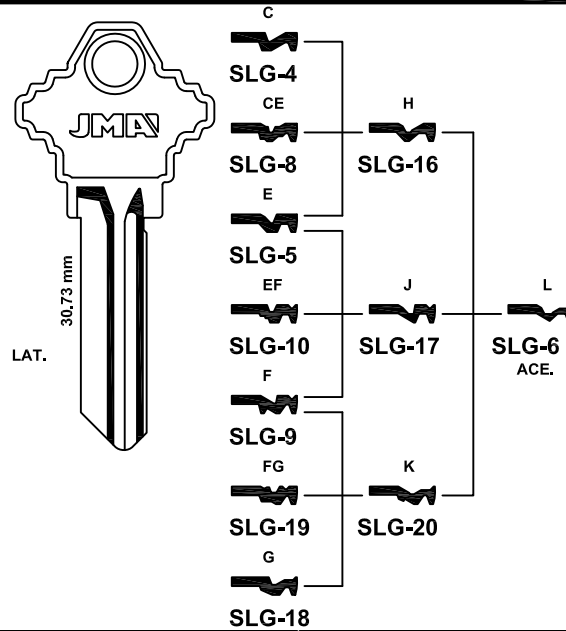
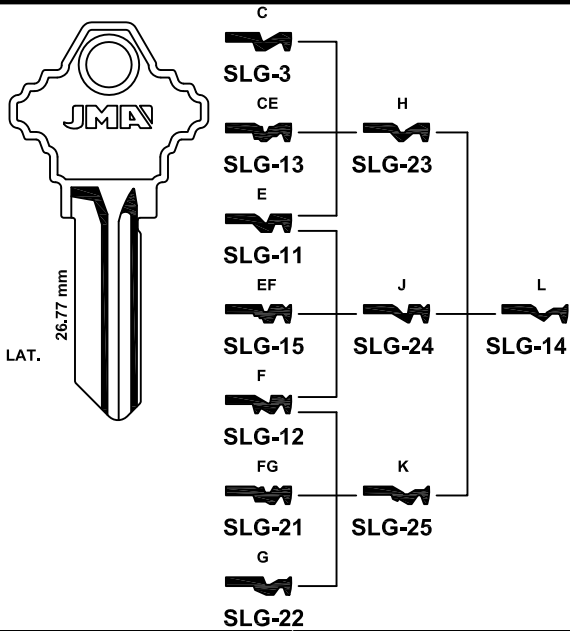

SCHLAGE

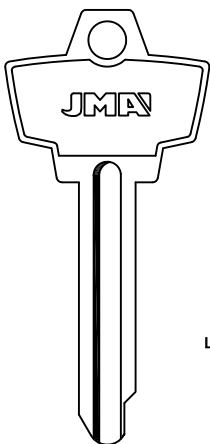

A
SLG-7

LAT.

SCHLECHTENDAHL

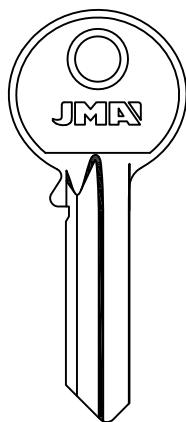

SCH-1D

CASI-HUTRA-NORDWEST

SCHUCO

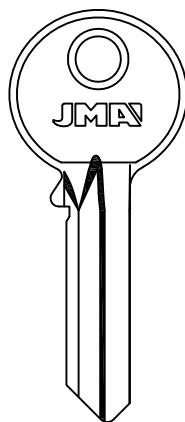

SCC-1D

SEA

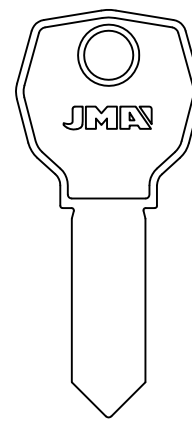

9.5
20-23
2.2
SEA-1

EZCURRA-HASLER-VIDMAR









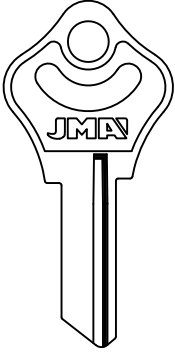
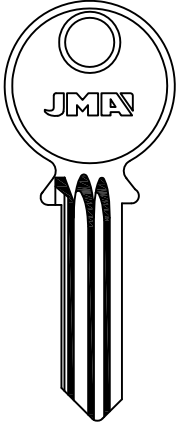
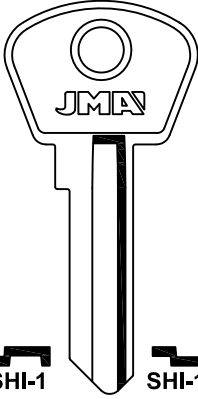
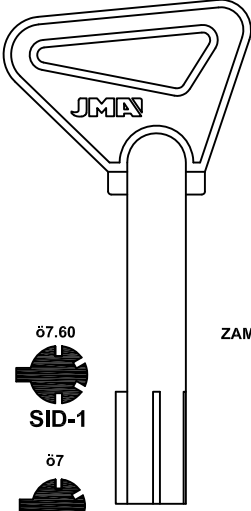

PARA-FOR:







- SEA (CH)
- SECUREMME (I)
- SECURITAL (I)
- SELECT (F)
- SELIVANOVSK (RUS)
- SENTRY SAFE (USA)
- SERRALLER (E)
- SERRETA (E)



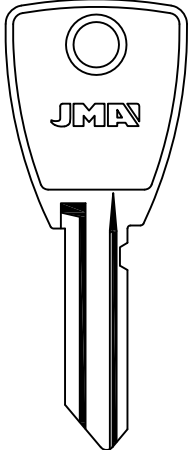
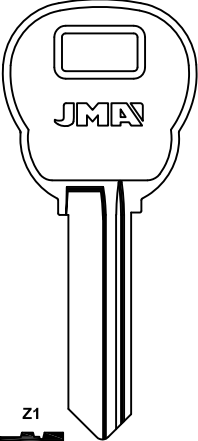
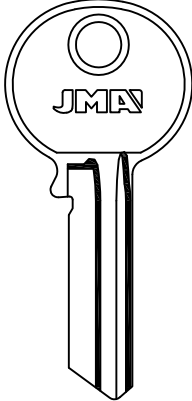
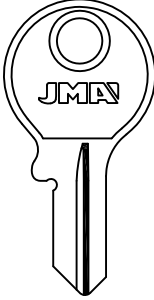





SEA	SECUREMME	SECURITAL	SELECT
 LAT.1 AL 7 9.5 2.2 SEA-2 EZCURRA-HASLER-VIDMAR	 LAT. 9.2 KP2 2.4 SEC-1 K1 2.85 SEC-2 2.37 SEC-3	 ZAM. 5.46 1.9 SCR-1 KYR	 33.5 mm. SEL-1I SEL-1D
SELECT			SELIVANOVSK
 43.5 mm. SEL-2I SEL-2D	 SEL-3D	 SEL-4D	 SL-1
SENTRY SAFE	SERRALLER	SERRETA	
 LAT. SEN-1D	 LAT. SEN-2D	 LAT. SER-3D	 7-S

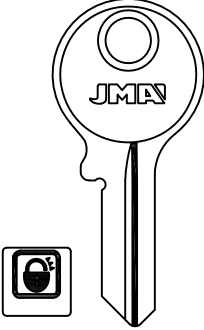
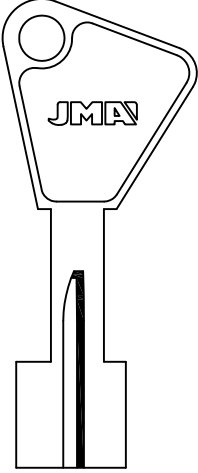
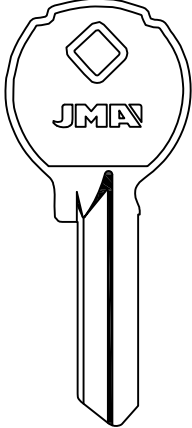
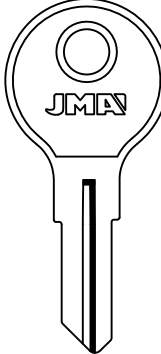

SHANGAI	SHAW	SHILUTE	SIDESE
			
 SHA-1	 SH-1I	 SHI-1	 SID-1
CINA	HTV-VAUGHN-YALE	 SHI-1D	 SID-2
		 SHI-2D	ZAM.
		 SHI-3D	

PARA-FOR:
 SHANGAI (RC)
 SHAW (GB)
 SHILUTE (RUS)
 SIDESE (E)
 SIMECA (CH)
 SIS (I)

SIMECA			SIS
			
 SM-1	 SM-2	 SM-4	 SIS-1
GUTLER-KATE-ORBA SIAM-SIMATIC	 SM-3	 SM-4D	FEL
	Z1 GUTLER-KATE-ORBA SIAM-SIMATIC		
	40		

SIS			
			
 SIS-2			
 SIS-6	 SIS-6D		
 SIS-7D	 SIS-3	 SIS-4D	 SIS-5D
UTZ-ZENITH		LÅSBOLAGET	
			LAT.



PARA-FOR:

- SIS (I)
- SISO (I)
- SJL (RUS)
- SOFER (P)
- SOFI-SONAFI (P)
- SOLER (E)
- SOPRANO (BR)

		SIS		SISO		SJL	
				EVERGOOD-JOMA			
SOFER		SOFI-SONAFI					
SIL		26.4 mm		29.1 mm			
SOFI-SONAFI		SOLER		SOPRANO			
		90 mm					



SOS

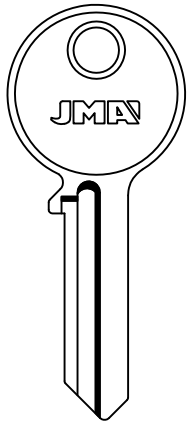

 SOS-1D

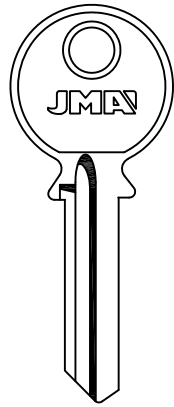

 SOS-2D

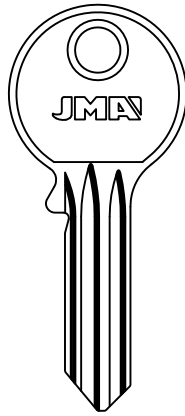

 SOS-3

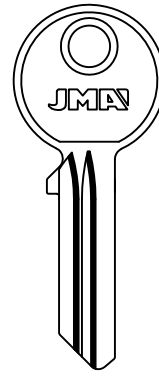

 SOS-4D

PARA-FOR:

- SOS (F)
- SPIDER (IL)
- SQUIRE & SONS (GB)

SOS

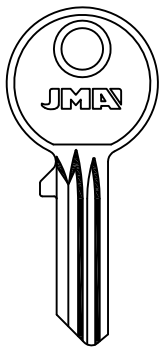

 SOS-5

SPIDER

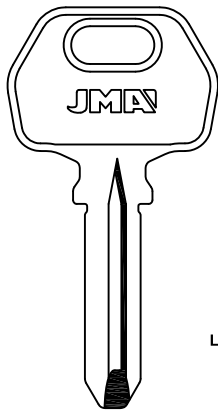

LAT.

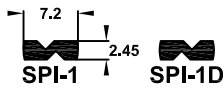

CAVERS-CODKEY-LOCKSYS

SQUIRE & SONS

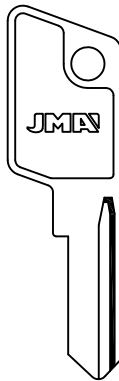

 SQ-1

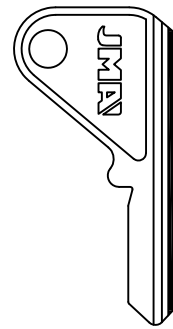

 SQ-2

SQUIRE & SONS

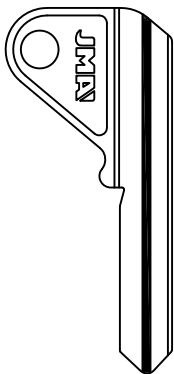

 SQ-3D

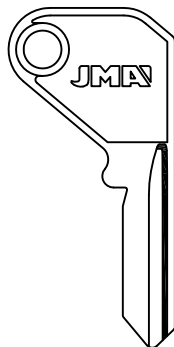

 SQ-4

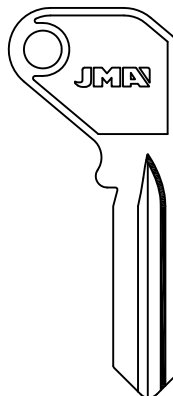

 SQ-5D

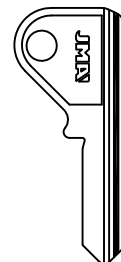

 SQ-6



PARA-FOR:











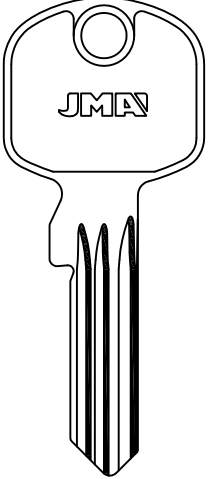

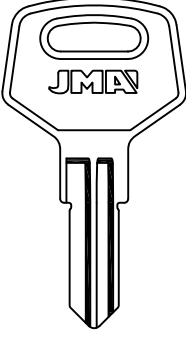
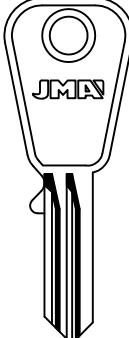





- SQUIRE & SONS
(GB)
- STA-LOCK (GB)
- STAR (J)
- STARLET (D)
- STEKLOMASH
(RUS)

SQUIRE & SONS		STA-LOCK	
SQ-7	SQ-8D	STL-1D	STL-2I
		SECURE	SECURE









STAR							
STA-1	STA-1D	STA-2	STA-2D	STA-3	STA-3D	STA-4	STA-4D

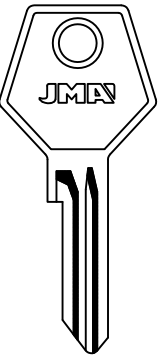
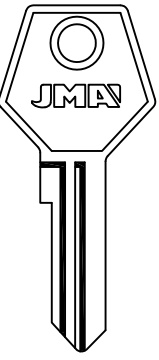
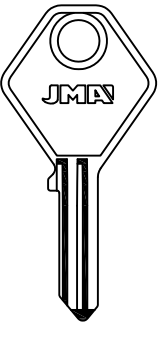
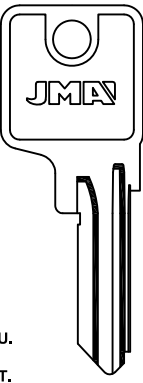









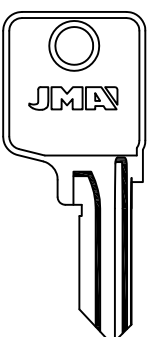
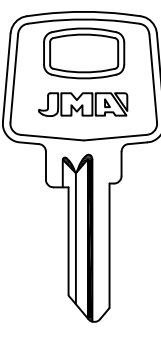

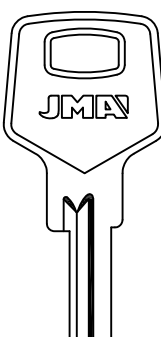
STAR	STARLET		STEKLOMASH
STA-5	STA-5D	ST-1I	ST-2
			STK-1



STEM			STERLING	STREBOR
	 STE-8D			
	 STE-7	 STE-14D		
	 STE-6	 STE-13D		
	 STE-5D	 STE-12		
	 STE-4	 STE-11		
	 STE-3	 STE-10		
 STE-1	 STE-2D	 STE-9D	 STG-1	 STR-1
GE GE				

PARA-FOR:
 STEM (D)
 STERLING (GB)
 STREBOR (GB)
 STS (E)

STREBOR			STS	
				
			ALU. LAT.	
 STR-2	 STR-4	 STR-5	 STS-1I	 STS-1D
TS...300-369 INNOCENTI	S..1-70		 STS-28	 STS-1D.P

STS				
				
				
 STS-3I	 STS-3D	 STS-4D	 STS-4D.P	 STS-6D
SEMEL	BTV	BTV	BTV	

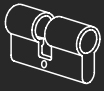

PARA-FOR:

STS (E)

STUBLINA (SCG)

STUMPF (D)

STUV (D)

STS

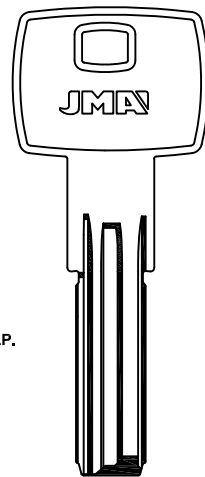
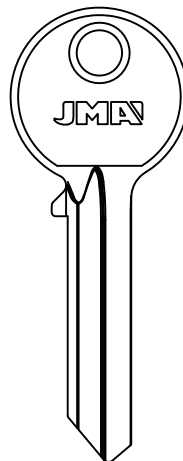
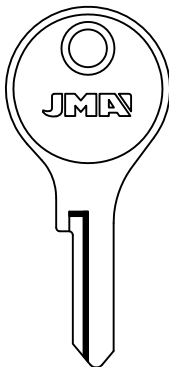
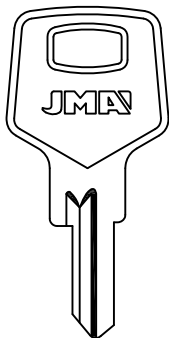

STS-7D

BTV

STS-12D

DAD

STS-13D

STS-21D

STS-35

MEGA6
STS-38

ALP.

LAT.

STS

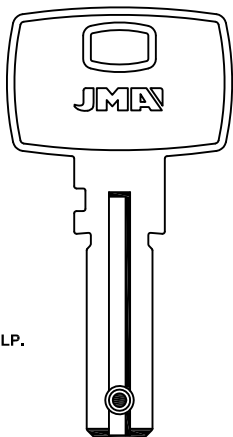

ALP.

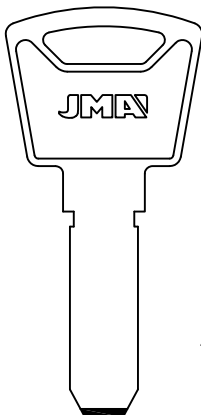

ALP.

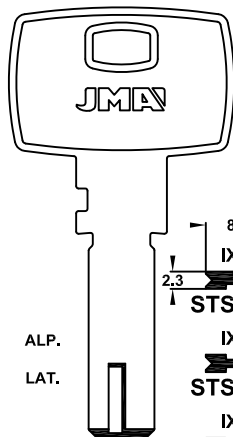

ALP.

LAT.

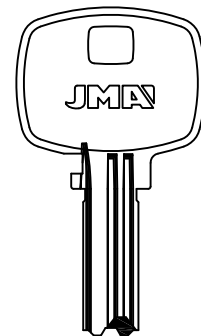

LAT.

IX-BOLA
8.5
2.3
STS-B1

8.8
2.3
STS-T14

CAYS

8.5
2.3
IX-3
STS-TV3
IX-5
STS-TV5
IX-8
STS-TV8
IX-9
STS-TV9
DOM-ESAFE
FAC-IFAM
SERRALLER
TECSESA
TECNOLAR

7.1
2.3
STS-X5

STS

STUBLINA

STUMPF

STUV

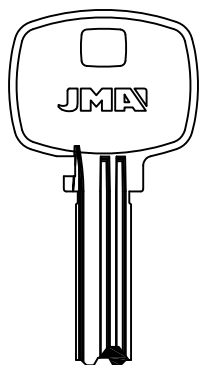

LAT.



7.1
2.3
STS-X6

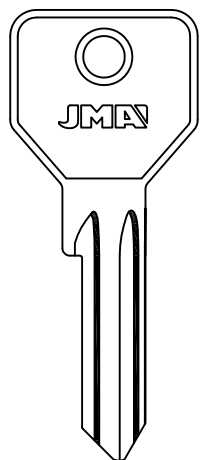

STB-1

STB-1D

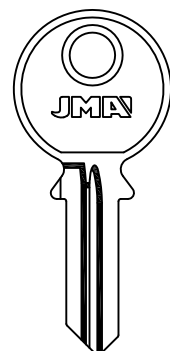

STF-1

STF-1D

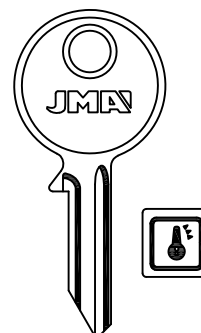

1F...201-278
1F...Z201-278
1F...X201-278

2F...
201-278

STUV-1I

STUV-1D

9F
STUV-3

DOM-MLM



STUV

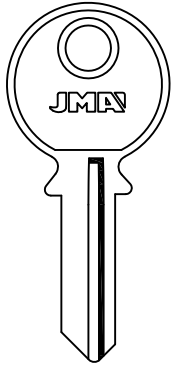

STUV-2

SUREX

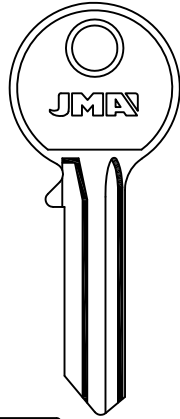

SR-1I

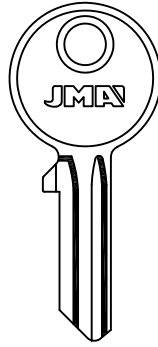

SR-2

ATLAS

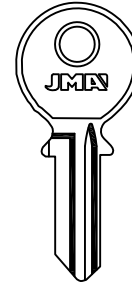

SR-3

ATLAS-EUROP-MATTEY

PARA-FOR:

- STUV (D)
- SUREX (F)
- T-KEY
- TAITO (J)
- TALLINN (RUS)

SUREX

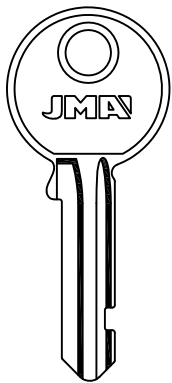

SR-4

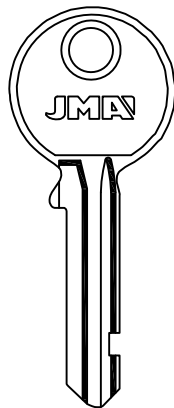

SR-5

T-KEY

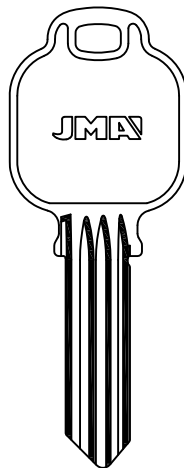

TKY-1

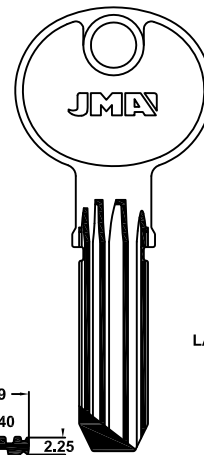

TKY-2

LAT.

TKY-3

BAILING LOCK

TAITO



TAI-1

TALLINN

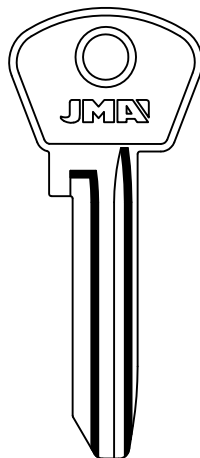

TAL-1

TAL-1D

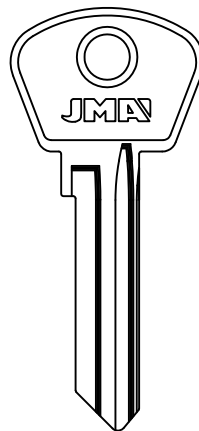

TAL-2

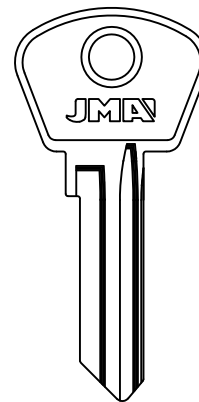

TAL-3



PARA-FOR:

- TARONI (I)
- TAYLOR (USA)
- TECON (E)
- TECSESA (E)
- TEICOCIL (P)
- TEKA (S)
- TEM (E)
- TESA (E)









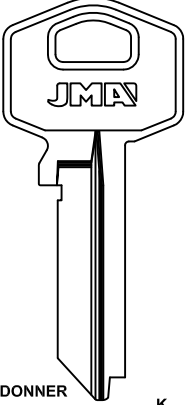

	TARONI	TAYLOR	TECON	
	<p>LAT.</p> <p>TRO-1 TRO-1D</p>	<p>TAY-1</p>	<p>LAT.</p> <p>TC-1 TC-2</p>	<p>TC5</p> <p>TC-2</p>
	TECSESA	TEICOCIL	TEKA	TEM
	<p>ALP.</p> <p>TEC-2</p>	<p>TEI-1D</p>	<p>20104 20004</p> <p>TK-2I TK-2D</p> <p>ASSA-ERMEX-LM</p>	<p>TEM-I35 TEM-D35</p>
	TEM	TESA		
	<p>TEM-I55 TEM-D55</p> <p>CORSA</p>	<p>* LAT.</p> <p>TE-1I TE-1D</p>	<p>TE-3</p> <p>MR</p>	<p>TE-4</p> <p>IFOS</p>

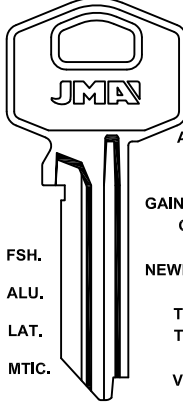



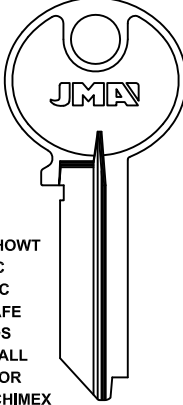

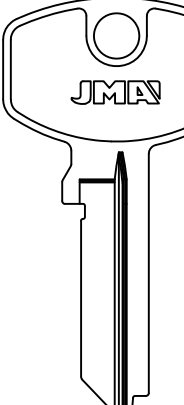



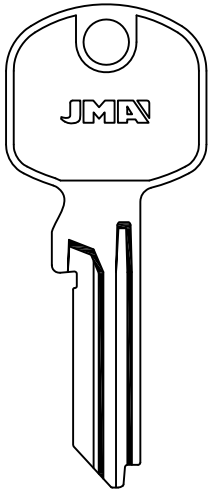

TESA

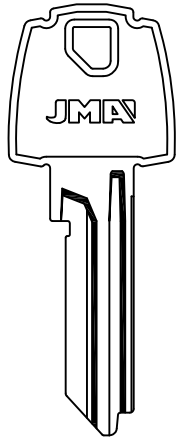
PARA-FOR:

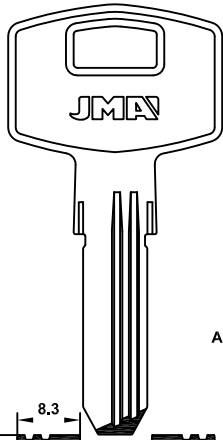
TESA (E)



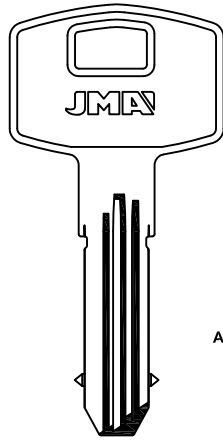



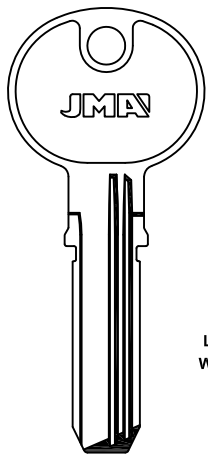

 <p>DONNER ESCO FORTRESS GAINSBOROUGH HARLOC KAWE MASTERCRAFT TAYMOR</p> <p>K 0 AL 9 AZ 1 AL 9 </p>	 <p>* FSH. * ALU. * LAT. * MTIC.</p> <p> * TE-8I T..... 0 AL 9</p>	<p>AGUEDA BENCO KAWE GAINSBOROUGH GELBAU HERPE NEWMAN TONKS SE TECHNAL TEICOCIL ORION VENLOCK</p> <p> TE-8D  TE-8DKT1</p>	 <p>BURGHOWT CC DJC ESAFE IFOS INSTALL LUXOR METALCHIMEX METALUX SES SOS</p> <p> TE-9D  TE-10I</p>	 <p> TE-11D</p>
---	--	--	--	--

TESA

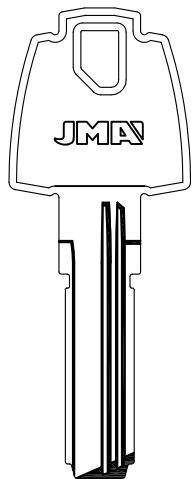
 <p> TE-23</p>	 <p> TE-28</p>	 <p>ALP.</p> <p>8.3 2.3  TE-T10  TE-T10D T10P  TE-T11</p>	 <p>ALP.</p> <p> TE-T12PLUS</p>
--	---	--	---

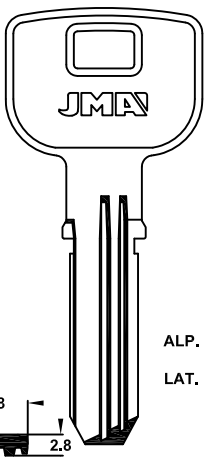
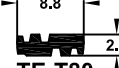
CORNIELCA-ESAFE-FAC-STS

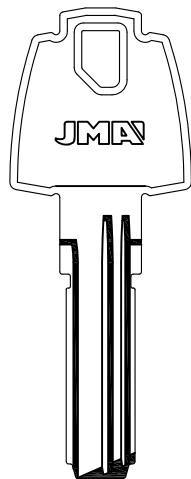
TESA











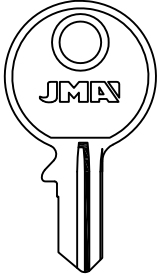
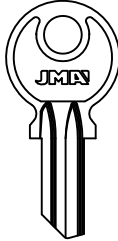
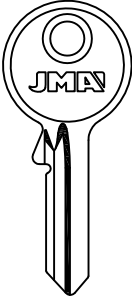
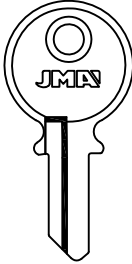





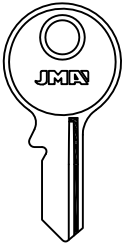
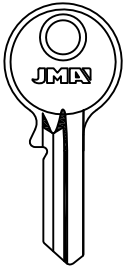
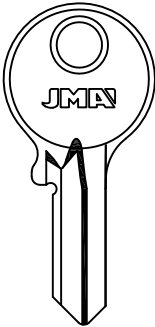
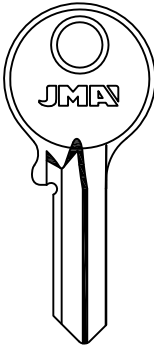

 <p>LAT. WNC.</p> <p>8.9 2.8  TE-T60</p>	 <p>LAT.</p> <p>8.9 2.8  TE-T62</p>	 <p>ALP. LAT.</p> <p>8.8 2.8  TE-T80 SC  TE-T80SC</p>	 <p>ALP.</p> <p>8.8 2.8  TE-T82</p>
---	---	--	---

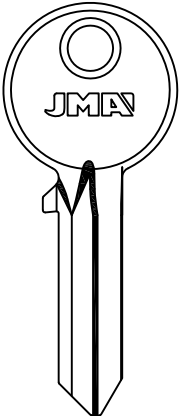
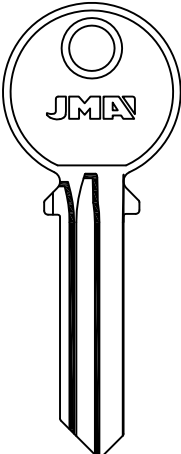
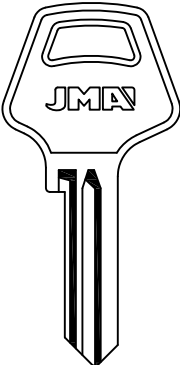
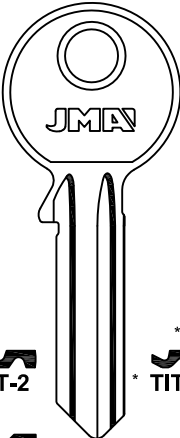
THOMAS LAIDLAW ESAFE-STS-TOPLOCK-YEMAR



PARA-FOR:

- TH (D)
- TICINO (I)
- TIFON (RC)
- TIGRIS (GB)
- TITAN (SLO)

TH	TICINO	TIFON	
			
 TH-1 <small>TRUMPH</small>	  TI-1 TI-1D <small>BERTOLOTTI</small>	  TIF-1D	 TIF-2D
TIFON			
			
 TIF-15/20	 TIF-25D	 TIF-30D	 TIF-40D
TIFON	TIGRIS	TITAN	
			
  TIF-50/60	 TIG-1D	 TIT-1D <small>HILLMANN-PAYKAN</small>	 TIT-2  TIT-10  TIT-2D <small>* ALU.</small>



TITAN

PARA-FOR:

TITAN (SLO)

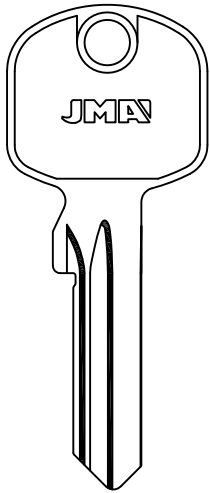

TIT-2GD

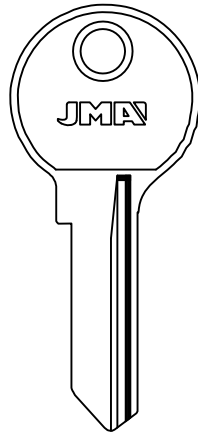

TIT-3

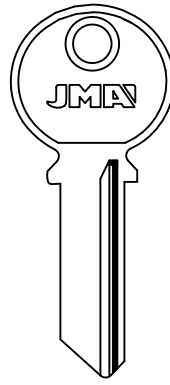

TIT-4

FTH-VACHETTE

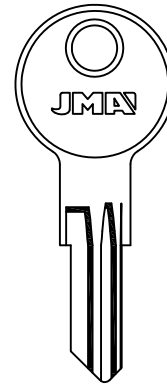

TIT-5

TITAN

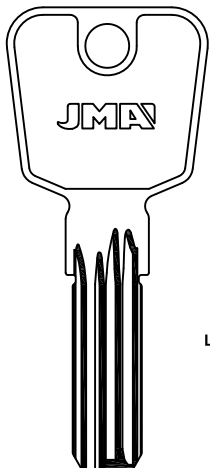

LAT.

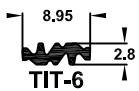

TIT-6

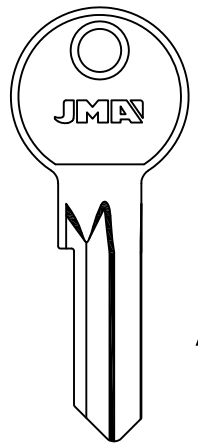

ALU.

TIT-8D

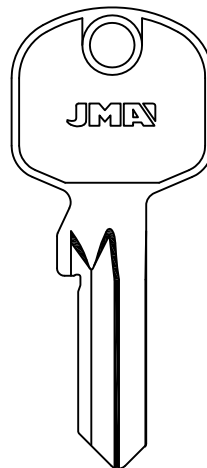

TIT-8GD

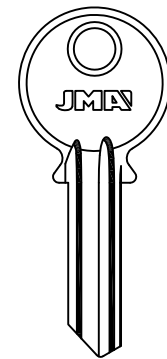

TIT-9

TIT-9D

LAMA

TITAN

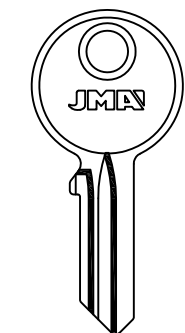

...251-300

TIT-11D



TIT-12D

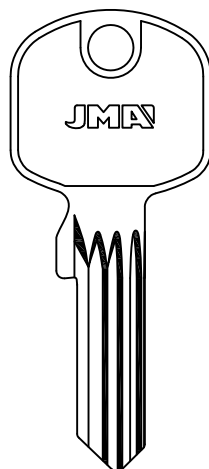

TIT-13

PICARDIE

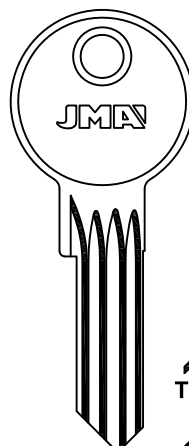

TIT-15

PICARDIE

TIT-18D

TIT-16D

TIT-15D

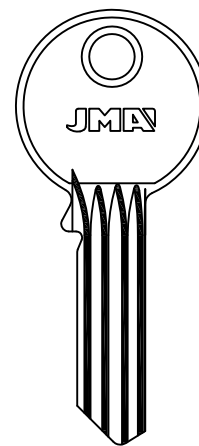

TIT-17



PARA-FOR:
TOK WINKHAUS
(D)

TOK WINKHAUS

TOK-2 TOK-2D TOK-3 TOK-3D TOK-4D TOK-5D

TRELOCK TRELOCK TRELOCK COMBA-SIEBAU TRELOCK-VACHETTE

COL. N/T/9..... 0 AL 8 0 AL 8

TOK WINKHAUS

TOK-6 TOK-6D TOK-7D TOK-11 TOK-12 TOK-13D TOK-14D TOK-15 TOK-16D TOK-18 TOK-23 TOK-25 TOK-26 TOK-27 TOK-28D TOK-32 TOK-33 TOK-34D TOK-35D

N..... T..... 9.....9 0 AL 8

EFAFF BFA1 BFA2 EFAM EFWS EHBA EKCP FAABF

EWSB BIF-1

FICHET-BIFFAR

TOK WINKHAUS

TOK-17D TOK-18 TOK-19 TOK-20 TOK-29D TOK-30 TOK-31

TRELOCK

TOK WINKHAUS

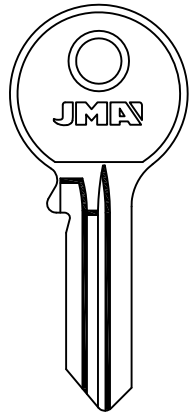

W
TOK-56D

TRELOCK

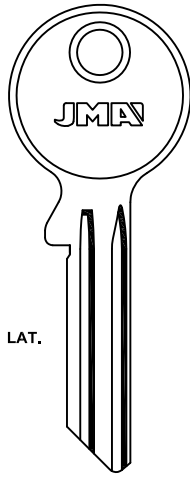

LAT.

LAT.



TOK-75



TOK-61



TOK-60



TOK-59



TOK-58



TOK-78



TOK-77

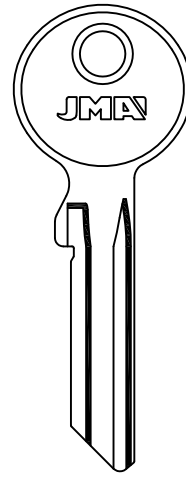

LAT.

TOK-76

SERIE AZ 01 N

PARA-FOR:
TOK WINKHAUS
(D)

TOK WINKHAUS

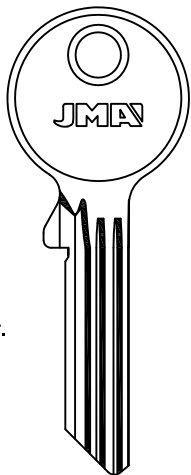

LAT.



X7
TOK-37



X6
TOK-62



X5
TOK-47



X4
TOK-21



X3
TOK-46



X2
TOK-45



X1
TOK-44



X6
TOK-62D



X5
TOK-47D



X4
TOK-21D



X3
TOK-46D

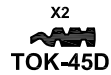

X2
TOK-45D



X1
TOK-44D



X14
TOK-40



X13
TOK-8



X12
TOK-39



X11
TOK-38



X10
TOK-48



X9
TOK-67



X8
TOK-63



X10
TOK-48D



X18
TOK-69



X17
TOK-68



X16
TOK-41



X15
TOK-49



X16
TOK-41D

SERIE X

TOK WINKHAUS

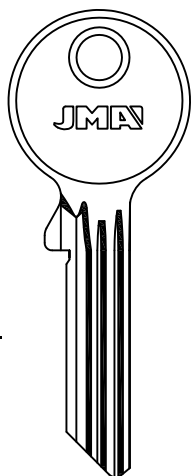

LAT.



Y7
TOK-52



Y6
TOK-43



Y5
TOK-51



Y4
TOK-70



Y3
TOK-22



Y2
TOK-42



Y1
TOK-50



Y14
TOK-24



Y13
TOK-72



Y12
TOK-66



Y11
TOK-64



Y10
TOK-54



Y9
TOK-53



Y8
TOK-71

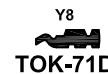

Y8
TOK-71D



Y18
TOK-74



Y17
TOK-65



Y16
TOK-55



Y15
TOK-73

SERIE Y

JMA[®]

Copyright by Alejandro Altuna S.A. 2014



ATENCIÓN: Concerniente a las marcas y denominaciones comerciales ver nota en índice.
ATTENTION: Concerning the marks and commercial denominations see note in index.
ATTENTION: Concernant les marques et dénominations commerciales voir la note dans l'index.
ACHTUNG: Beziehen auf die marke und handelsname sehen sie die notiz im index.

PARA-FOR:





TOMSK (RUS)



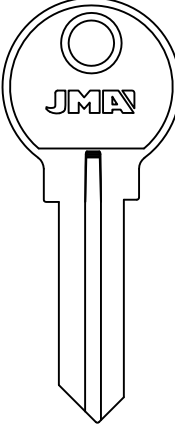
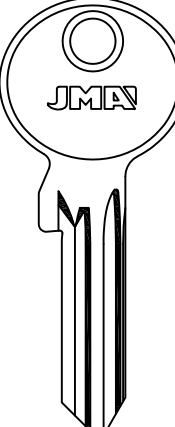
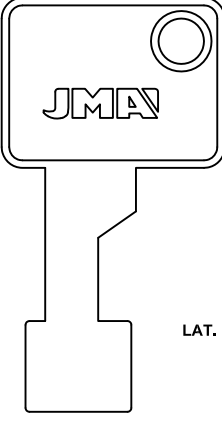
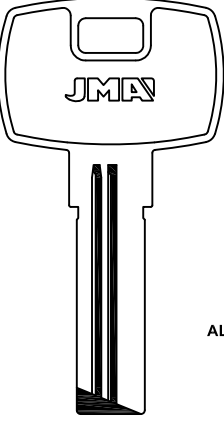

TOP (D)



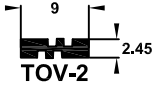

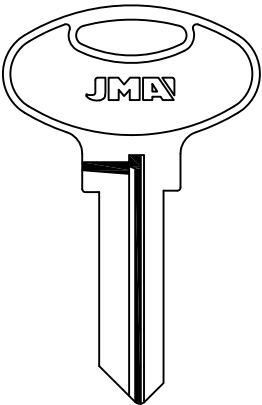
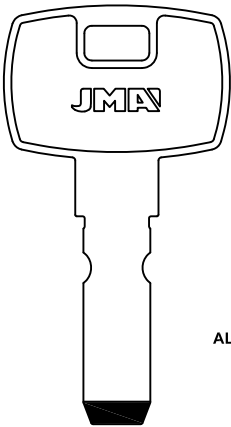
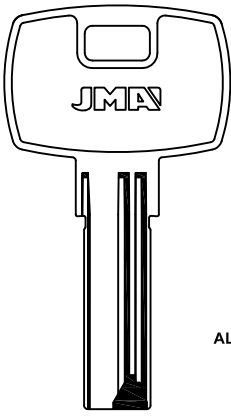
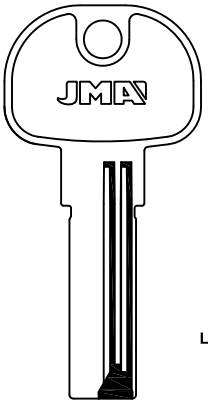
TOVER (E)

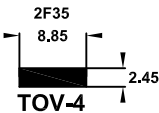
TRAVEX (PE)

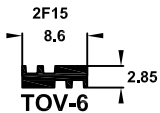
TRELOCK (D)

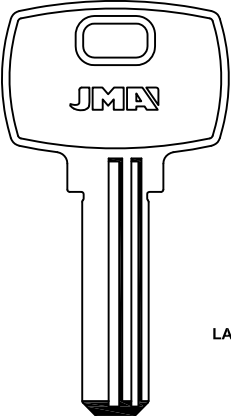
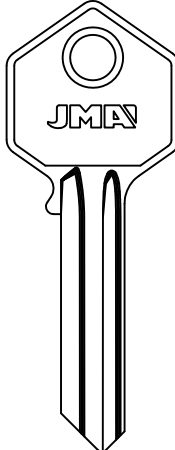
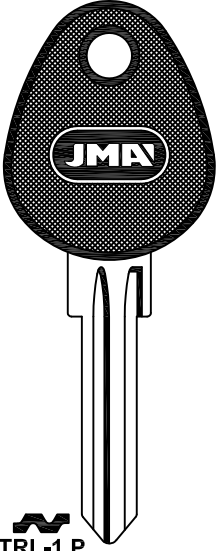
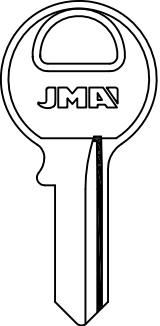
TOMSK	TOP	TOVER	
			
 TOM-1	 TOP-1 ABUS-NOVA	 TOV-1 TEICOCIL	 TOV-2

TOVER			
			
 TOV-3	 TOV-4 TROMER	 TOV-5	 TOV-6

TOVER	TRAVEX	TRELOCK	
			
 TOV-7	 TRV-1	 TRL-1.P	 TRL-2 HAMPTON



TRI-CIRCLE

PARA-FOR:
TRI-CIRCLE (RC)

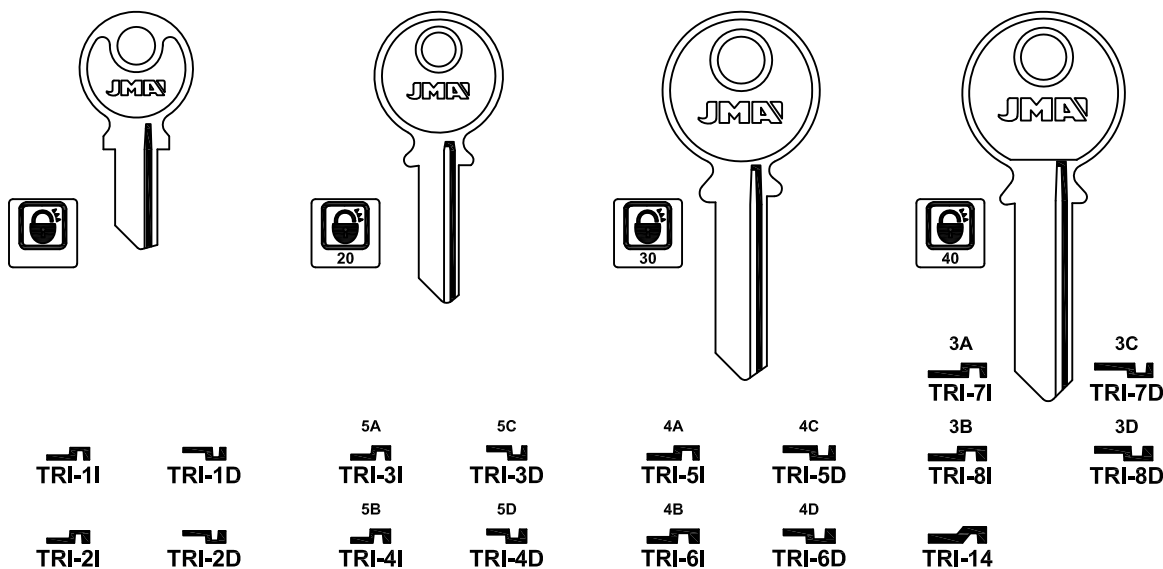

MARK

ELEPHANT

TRI-CIRCLE

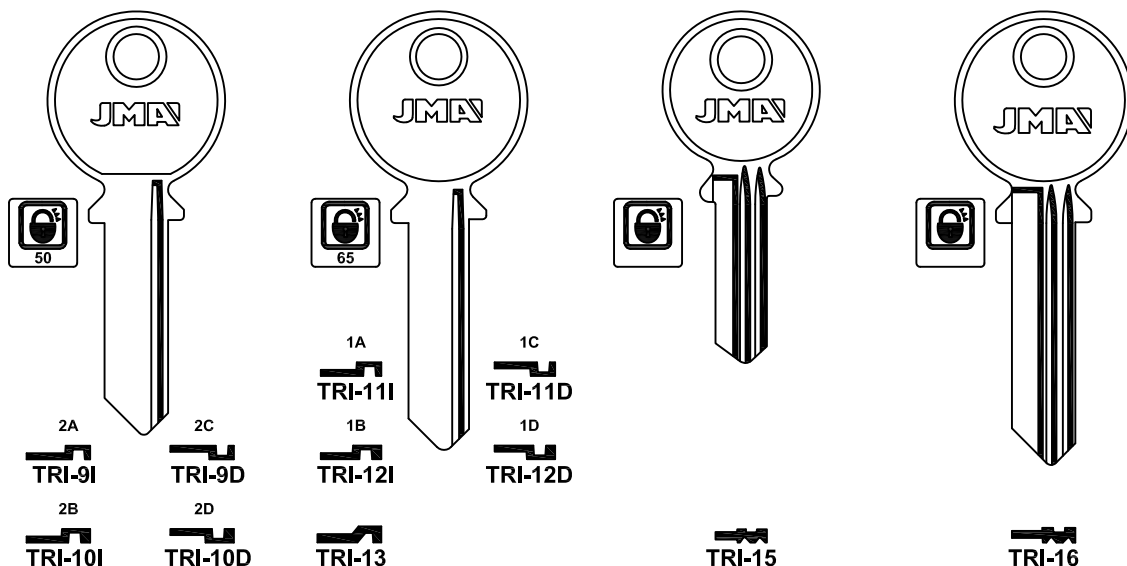

TRI-CIRCLE

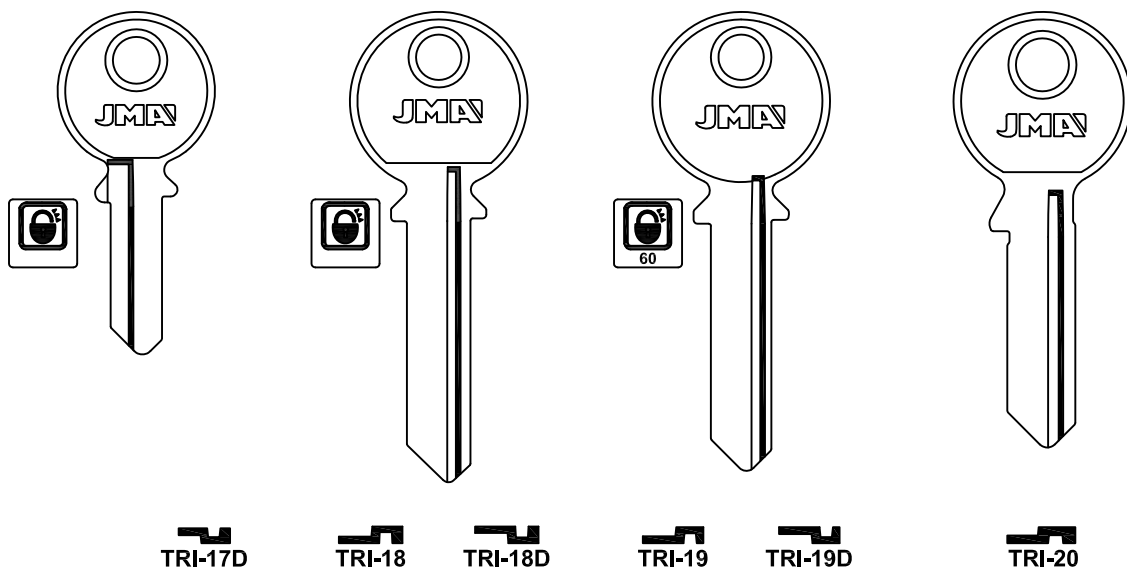





PARA-FOR:





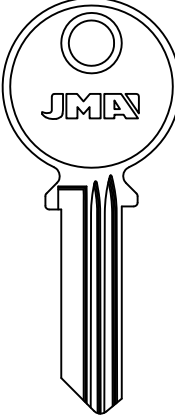
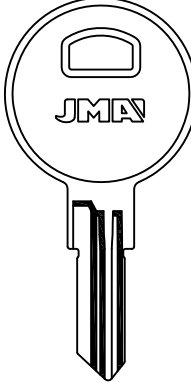
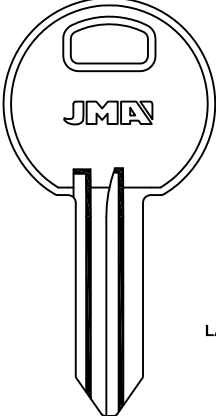
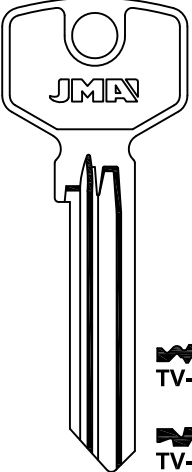



TRI STAR (RC)

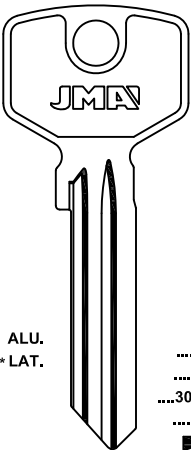
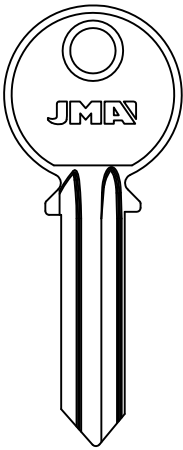
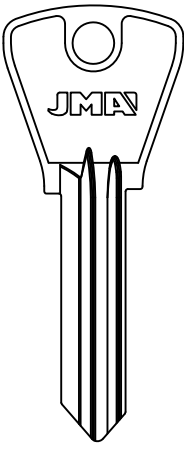
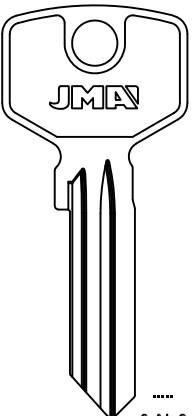









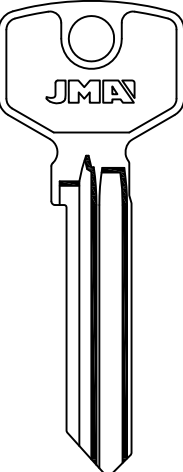

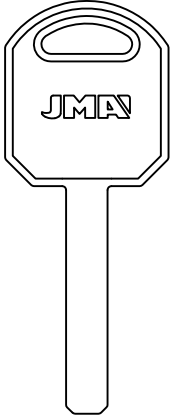

TRIMARK (USA)

TRIO-VING (N)







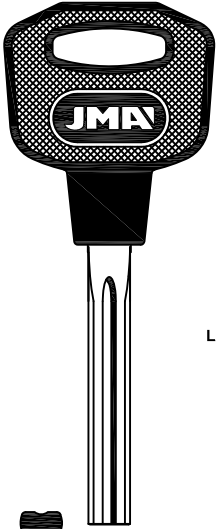

TRUPER (USA)

TRI STAR	TRIMARK		TRIO-VING
			
			
TST-1	TRM-4	TRM-11D	TV-13

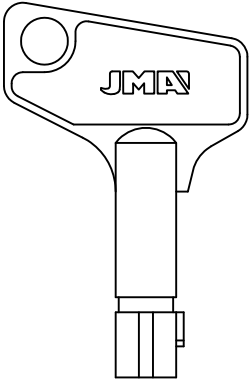

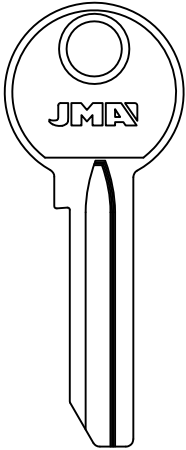

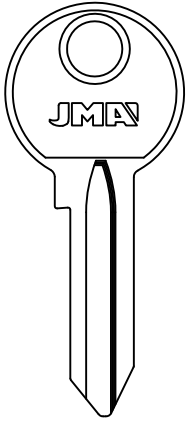



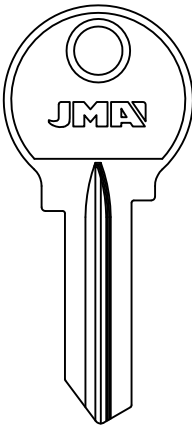

TRIO-VING			
			
ALU. *LAT.		ALU.	ALU.
.....1 AL 90 AL 930000-567691-26770  *TV-3D	 0 AL 9  TV-12 0 AL 9  TV-15D
 TV-4D	TRIO  TV-11	 TV-12	 TV-16D

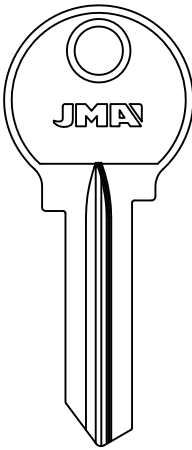
TRIO-VING	TRUPER		
	 * TV-17	 * TV-17D	
		 * TV-18D	
		 * TV-19D	
	 * TV-20		
	 * TV-21	 TV-32	
*LAT.	 * TV-22	 * TV-22D	
	 * TV-23	 * TV-23D	 TV-31
		 * TV-30	 TRU-7

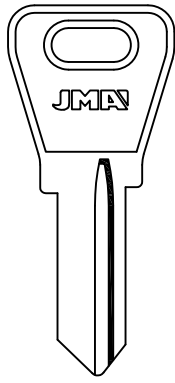



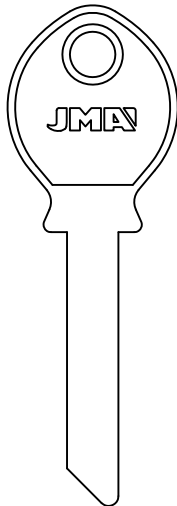



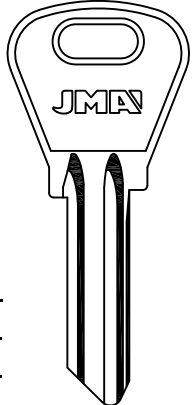

TRUPER	TSAG	TULA	
 <p>LAT.</p>  <p>TRU-8.P</p>	 <p>J</p>  <p>SAG-1T</p>	 <p>JMA</p>  <p>TUL-1D</p>	 <p>JMA</p>  <p>TUL-2D</p>

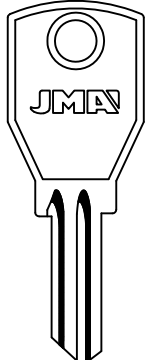
PARA-FOR:
 TRUPER (USA)
 TSAG (E)
 TULA (RUS)
 TUSHINO (RUS)
 TZAFRER (GR)
 UCEM (E)

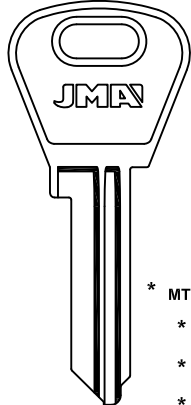
TUSHINO		TZAFRER		UCEM	
 <p>JMA</p>  <p>TUS-1D</p>	 <p>JMA</p>  <p>TUS-2D</p>	 <p>JMA</p>  <p>TZ-1</p>	 <p>JMA</p>  <p>TZ-1D</p>	 <p>JMA</p>  <p>5-L</p>	

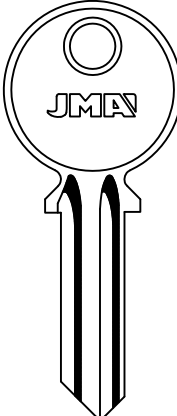
UCEM

 <p>JMA</p> <p>* ALU. * LAT. * FSH.</p>  <p>* UCEM-11</p>  <p>UCEM-1D</p>	 <p>JMA</p>  <p>UCEM-2I</p>  <p>UCEM-2D</p>	 <p>JMA</p> <p>* MTIC.(V) * ALU. * LAT. * FSH.</p>  <p>UCEM-3</p>  <p>UCEM-12 *</p>	 <p>JMA</p>  <p>UCEM-4I</p>
CIB-ENA.OQ-QCM-RIV		CIB-ND	STIQAM



PARA-FOR:

UCEM (E)
 ULIANOVSK (RUS)
 UMF (P)

UCEM

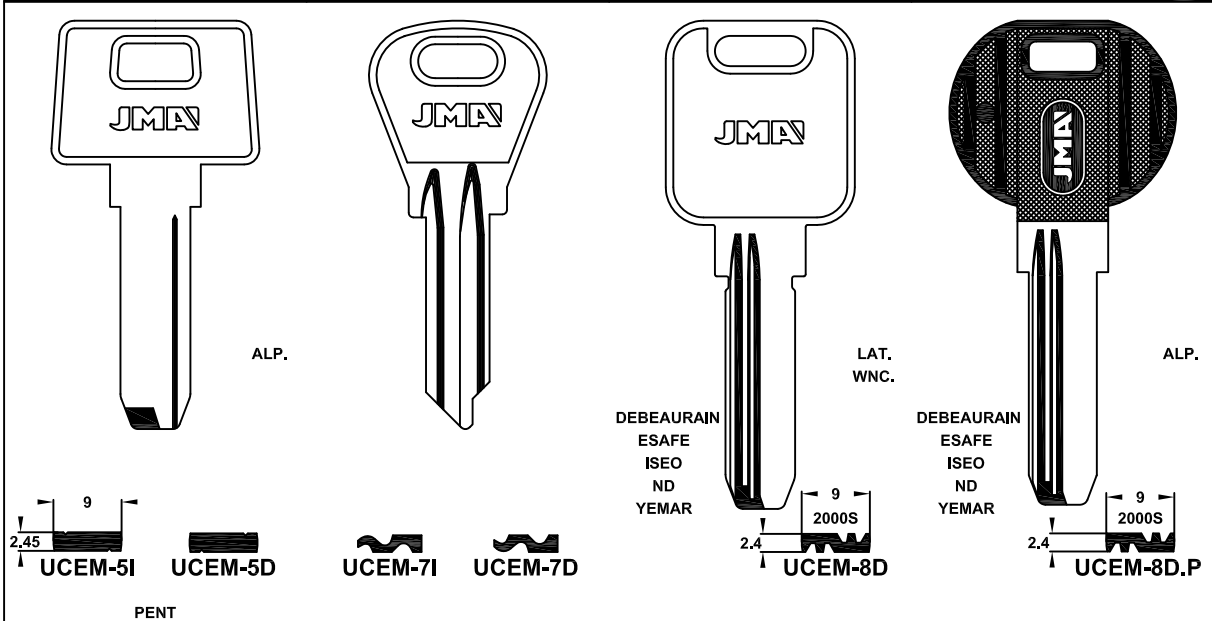

UCEM

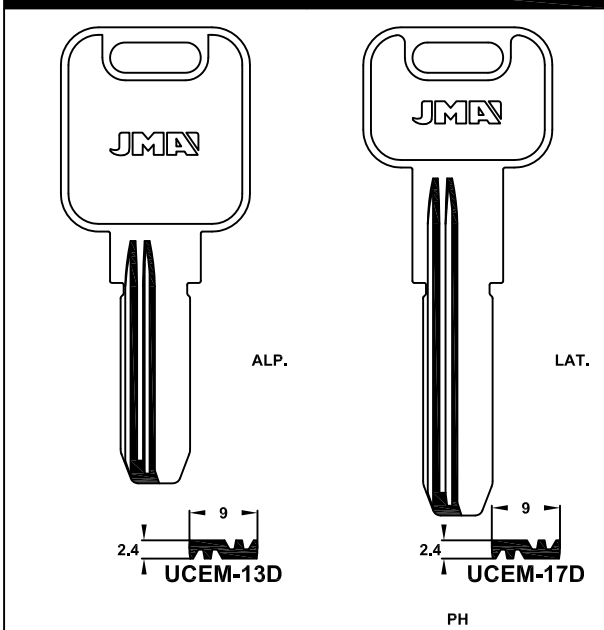

ULIANOVSK

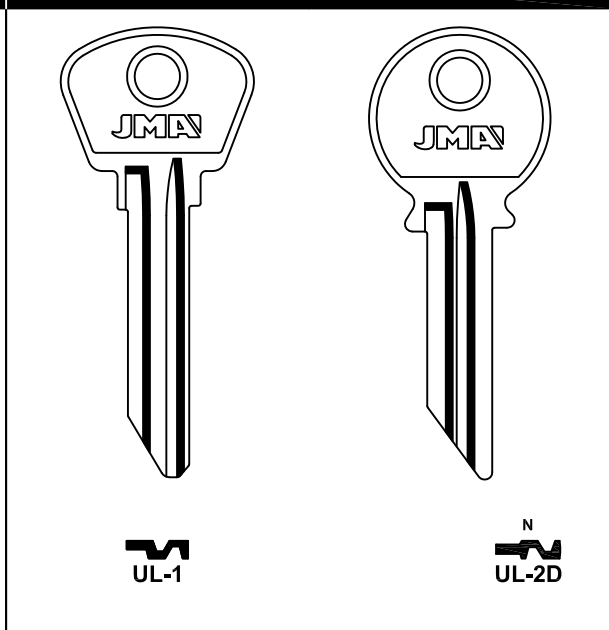

ULIANOVSK

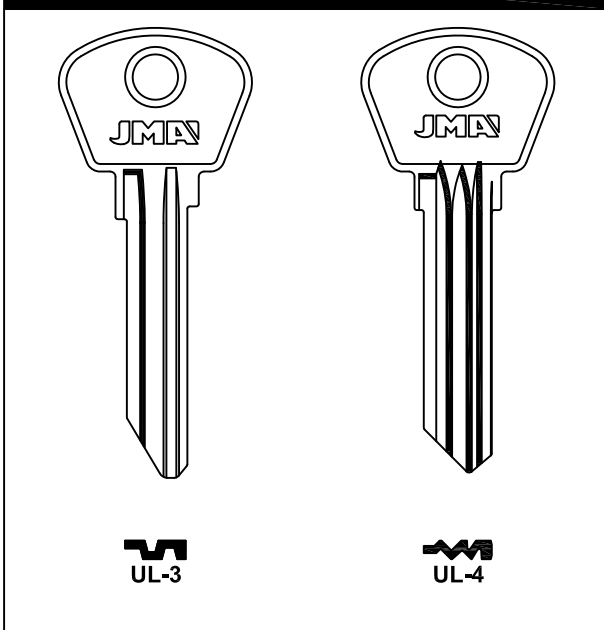

UMF

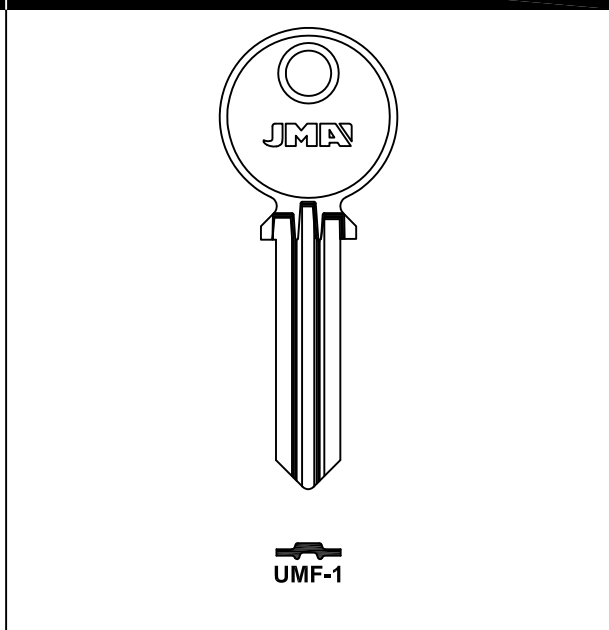

UNION

PARA-FOR:
UNION (GB)

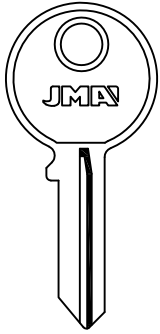

NRA
FFE...1-100
FJA...1-100
FL...251-500
NRA...51-90
YFB...1-75
FMD...1-75
FG...1-30
NF...1-30
EJR...1-75



UN-FFE

UN-3

FP...
626-750
UN-FP

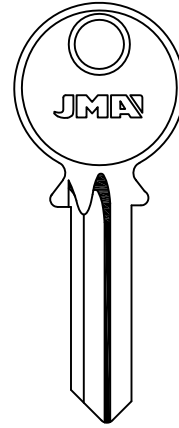
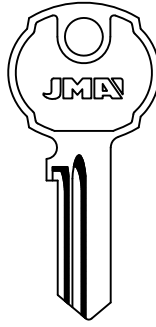

MC...1-40
MRA...251-290
MRN...1-54
MRN...201-250
MRN...251-300

UN-MRN

HX...100
UN-2

FR...
751-875
UN-FR

FS...1-99
FS...876-955

UN-1FS

FA...
501-625

UN-44

RM...
911-952

UN-44D

NGN...1-54

UN-NG

KB53A

UN-5D

KB506

UN-6D

BRITISH LEYLAND-FORD-HILLMAN-JAGUAR-LAND ROVER-MG-MORRIS-ROVER

UNION

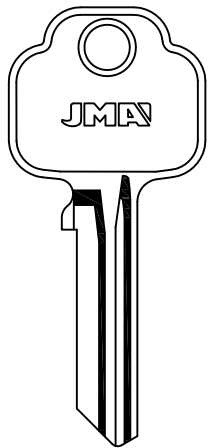

503
UN-12I
574
UN-13I
575
UN-14I
576
UN-15I
577
UN-16I
578
UN-17I
579
UN-18I

UN-7I

581
UN-19I
582
UN-20I
583
UN-21I
584
UN-22I
585
UN-23I
586
UN-24I
587
UN-25I
588
UN-26I
589
UN-27I

914
UN-13D
915
UN-14D
916
UN-15D
917
UN-16D
918
UN-17D
919
UN-18D

UN-7D

901
UN-19D
902
UN-20D
903
UN-21D
904
UN-22D
905
UN-23D
906
UN-24D
907
UN-25D
908
UN-26D
909
UN-27D

UNION

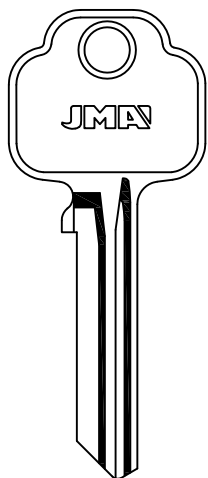

503
UN-28I
574
UN-29I
575
UN-30I
576
UN-31I
577
UN-32I
578
UN-33I
579
UN-34I

UN-8I

581
UN-35I
582
UN-36I
583
UN-37I
584
UN-38I
585
UN-39I
586
UN-40I
587
UN-41I
588
UN-42I
589
UN-43I

914
UN-29D
915
UN-30D
916
UN-31D
917
UN-32D
918
UN-33D
919
UN-34D

UN-8D

901
UN-35D
902
UN-36D
903
UN-37D
904
UN-38D
905
UN-39D
906
UN-40D
907
UN-41D
908
UN-42D
909
UN-43D

JMA®

Copyright by Alejandro Altuna S.A. 2014



ATENCIÓN: Concerniente a las marcas y denominaciones comerciales ver nota en índice.
ATTENTION: Concerning the marks and commercial denominations see note in index.
ATTENTION: Concernant les marques et dénominations commerciales voir la note dans l'index.
ACHTUNG: Beziehen auf die marke und handelsname sehen sie die notiz im index.

PARA-FOR:

UNION (GB)

UNIVERSAL

UNION

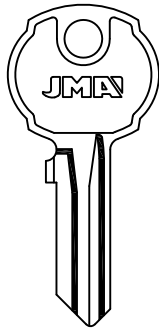

UN-9I

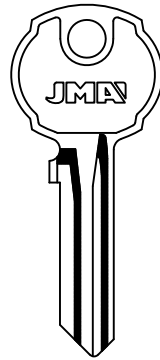

UN-9D

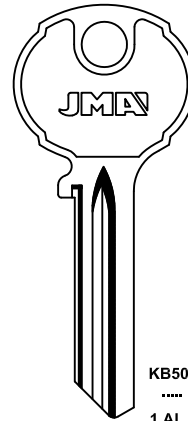

UN-10I



UN-10D

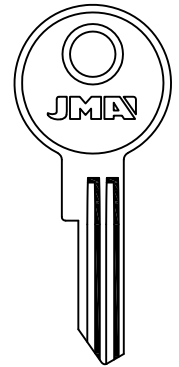

UN-45D



KB502
.....
1 AL 6
UN-11

KB682
UN-46D

ONIUM

UNION

UNIVERSAL

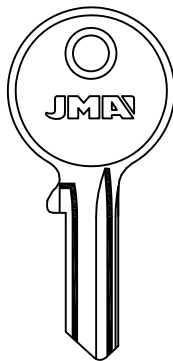

TBS...1-50
NKL...1-150
NND...1-150
TBS...1-500
TBS...201-350
UN-47

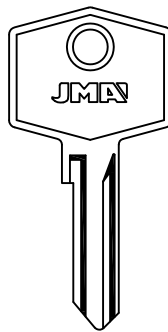

FK...
01-99
876-955
UN-FK
FS...
01-99
876-955
UN-FS
JAGUAR-VAUXHALL

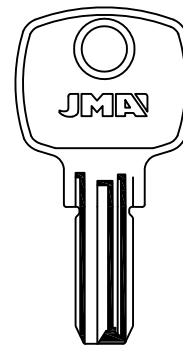

SH2-SH3
7.2
2
TX-1

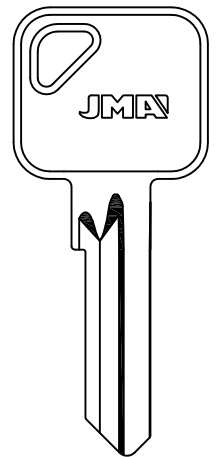

TX-3D

LAT.

EURO SPEC

UNIVERSAL

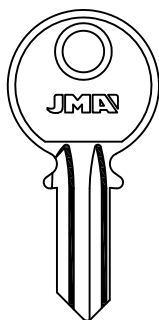

U-1I

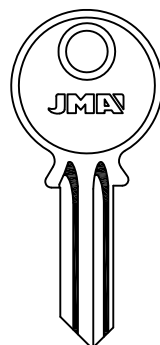

U-1D

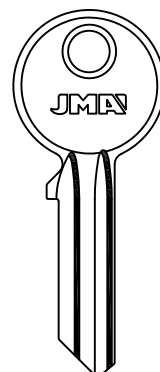

U-2I



U-2D

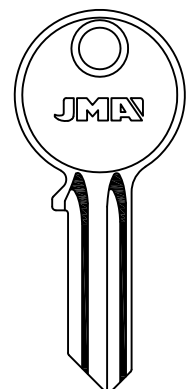

U-3I



U-3D



U-4I



U-4D

ALU.

TECNO



UNIVERSAL

PARA-FOR:
UNIVERSAL

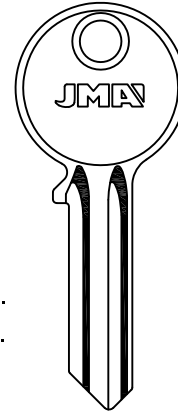
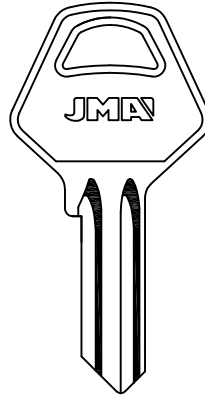
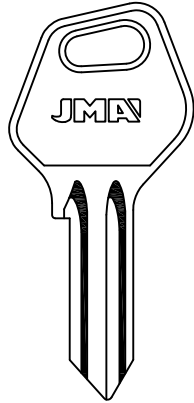
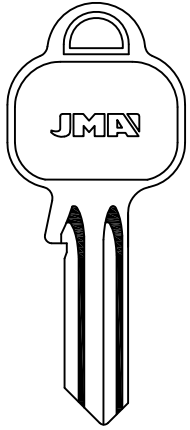

ALU.
* FSH.

U-4AI

U-4AD

U-4JI

U-4JD

U-4TI

U-4TD

U-5I

* U-5D

ESAFE-SIL

UNIVERSAL

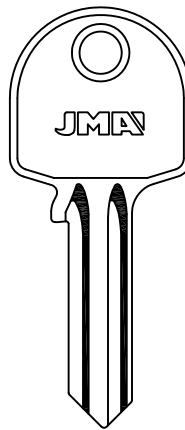
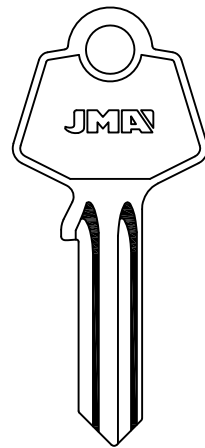
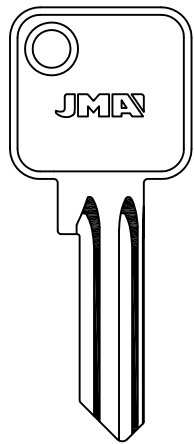
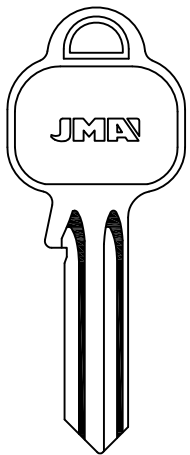

U-5AI

U-5AD

U-5BI

U-5BD

U-5CI

U-5CD

U-5DI

U-5DD

UNIVERSAL

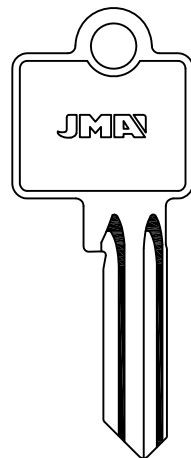
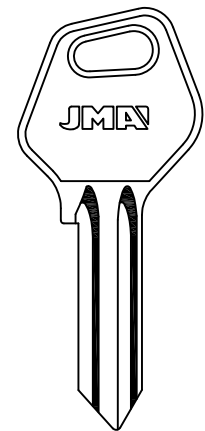
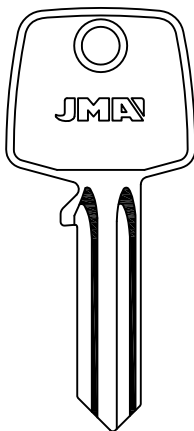
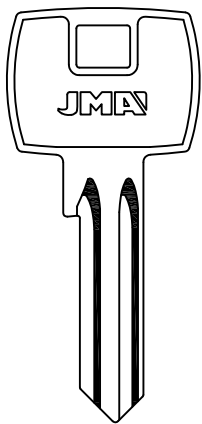

U-5EI

U-5ED

U-5FI

U-5FD

U-5JI

U-5JD

U-5KI

U-5KD



PARA-FOR:
UNIVERSAL

UNIVERSAL

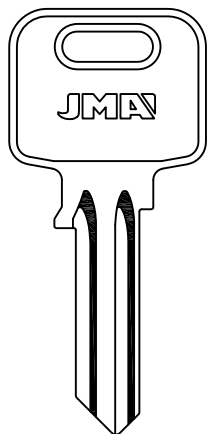

U-5MI

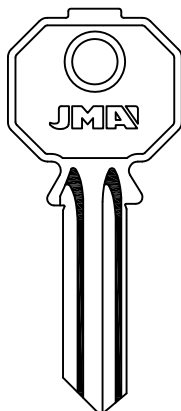

U-5MD

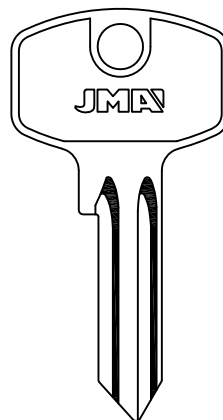

U-5PI

U-5PD

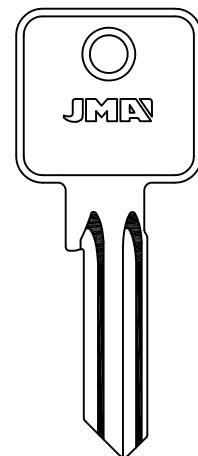

U-5QI

U-5QD

U-5SI

U-5SD

UNIVERSAL

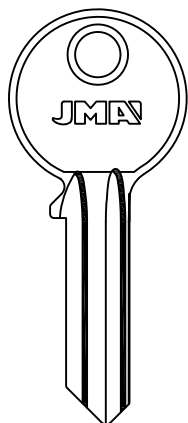

U-5SP

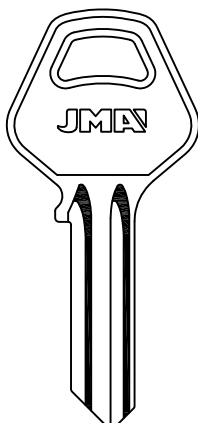

U-5DSP

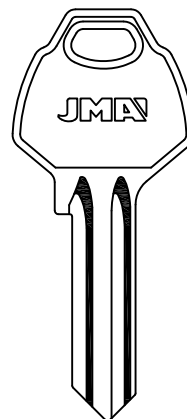

U-5TI

U-5TD

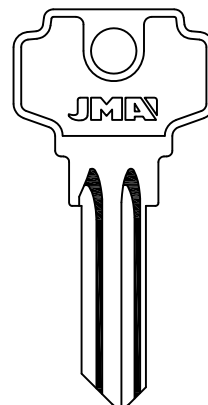

U-5VI

U-5VD

U-5XI

U-5XD

UNIVERSAL

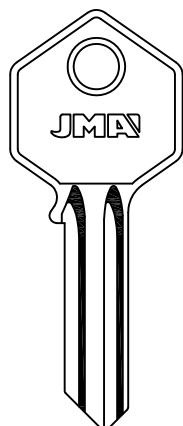

U-5YI

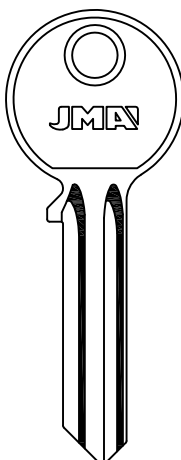

U-5YD

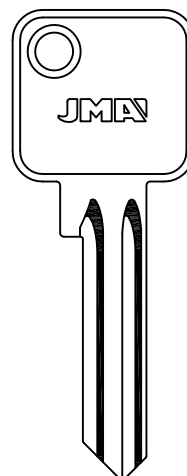

U-6I

U-6D

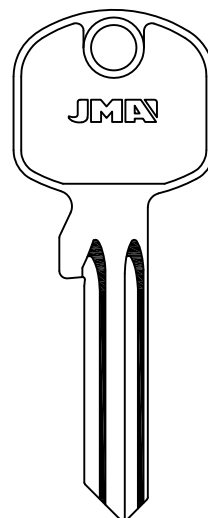

U-6BD

U-6GD

ALU.



UNIVERSAL

PARA-FOR:
UNIVERSAL

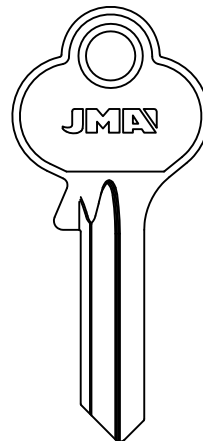
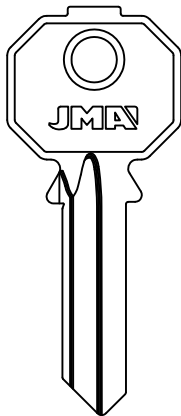
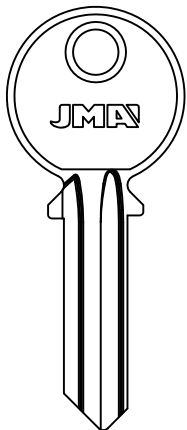
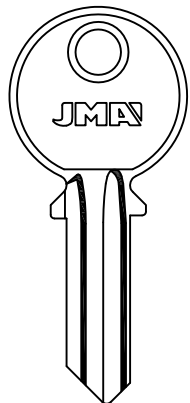

LAT.



TVO-1D

UNIVERSAL

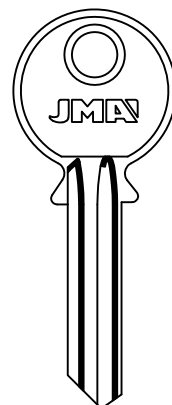
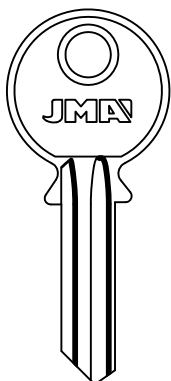
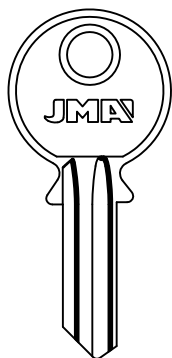
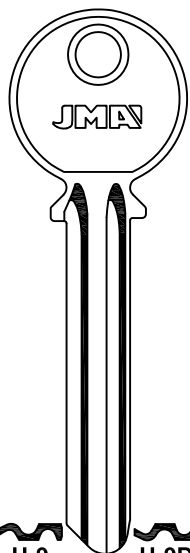

TVO-3D

TVO-2D

UNIVERSAL

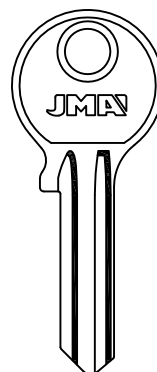
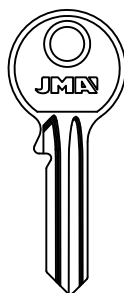
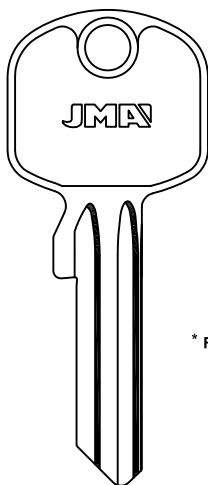
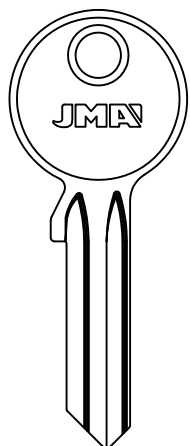

MTIC.

* FSH.



TVO-4D

CISA LOGO



PARA-FOR:

UNIVERSAL

URBIS (R)

URKO (E)

UNIVERSAL

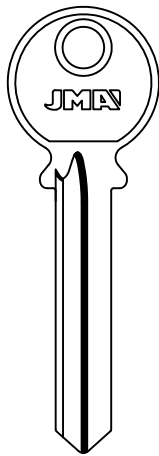

 U-18D

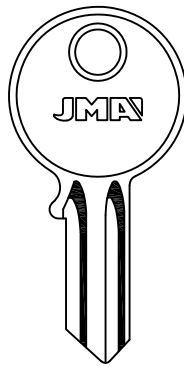

 U-19

LAT.

 U-19D

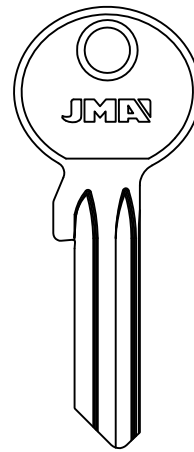

 U-21

 U-21D

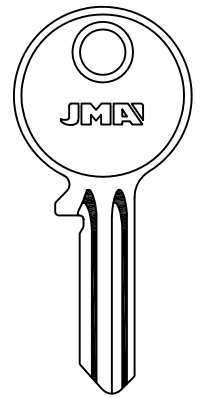

 U-22

 U-22D

UNIVERSAL

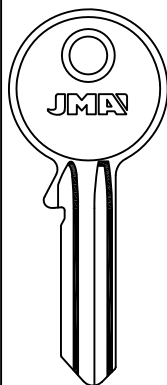

 U-25

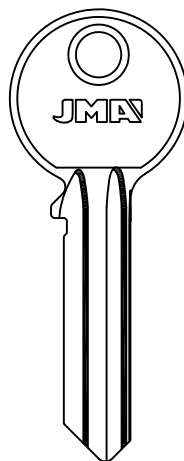

 U-25D

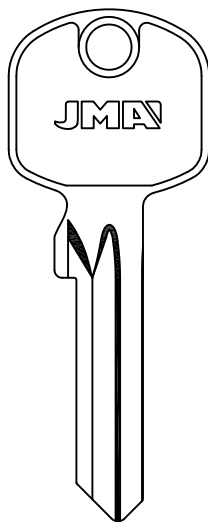

 U-26

 U-26D

 U-26GD

URBIS

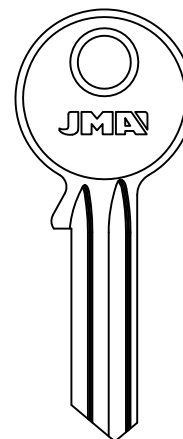

 URB-1

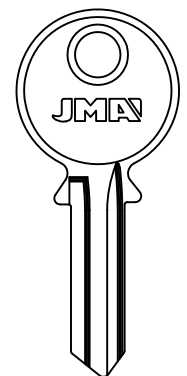

 URB-2

URBIS

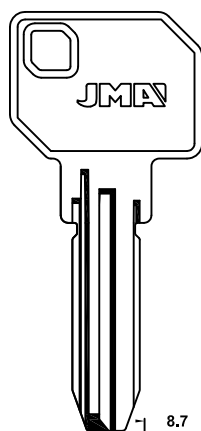

LAT.

 8.7 2.45
URB-3D

 URB-4D

BANE SEKULIC

URKO

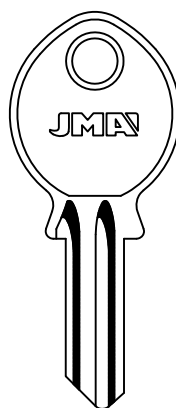

 URKO-11

 URKO-1D

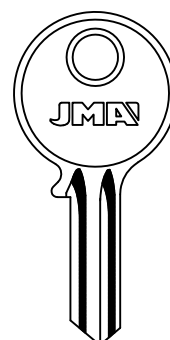

 URKO-21

 URKO-2D

 URKO-31

 URKO-3D

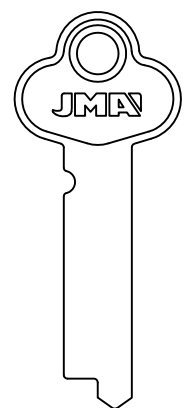

 URKO-4



VACHETTE

PARA-FOR:
VACHETTE (F)

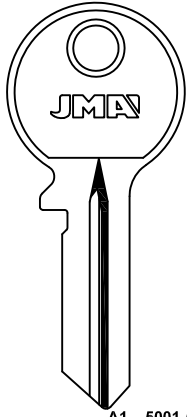

A1...5001-5631



VA-1



VA-75D

BAU-FONTAINE-HEMA-LAPERCHE
METALUX-MODERN-STREMLER



A...5000-5635

AY...0-249

Y...0-249

AS...0-099

S...0-099



VA-2



VA-5

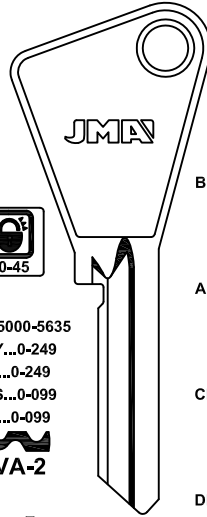

BM...870-894



VA-19

AM...870-894



VA-20

CM...870-894



VA-21

DM...870-894



VA-22

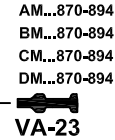

VA-23

AM...870-894
BM...870-894
CM...870-894
DM...870-894

VACHETTE

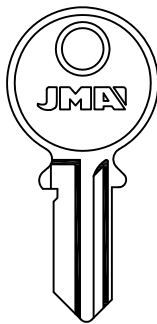

...1 AL 9 AL 0

E...9001-9100

...R9001-9100



VA-3I



VA-3

ISEO-KLIT

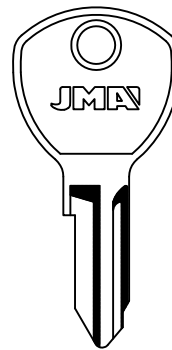

R...0-423



VA-4

V...0-423



VA-13I

G...0-423



VA-4D

W...0-423



VA-13D

ATAL-VINCO

VACHETTE

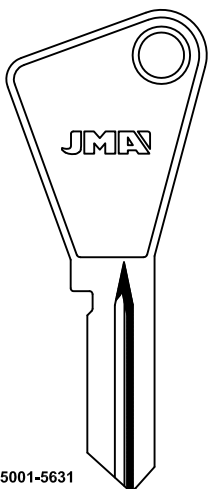

A1...5001-5631
UL...1-3500
U...1 AL 9 AL 0



VA-8D

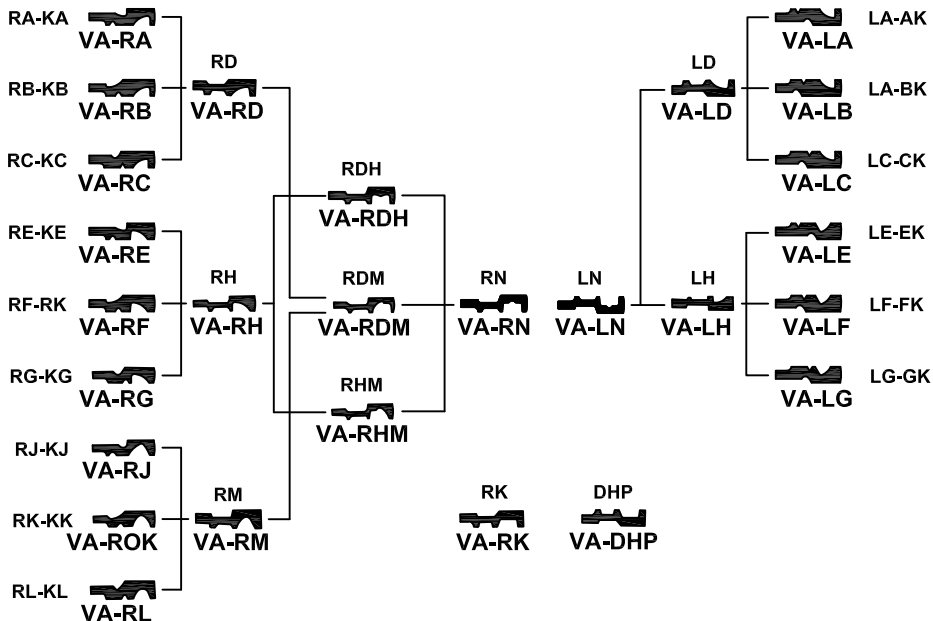

PARA-FOR:
VACHETTE (F)

VACHETTE

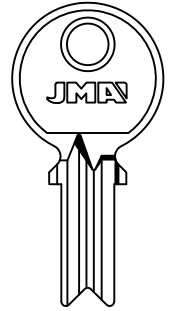
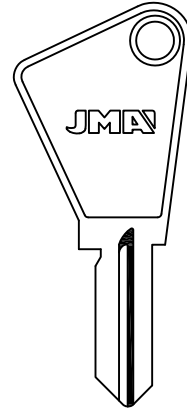
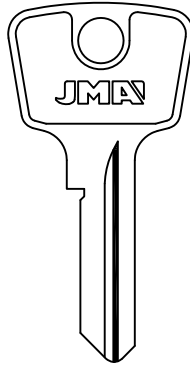
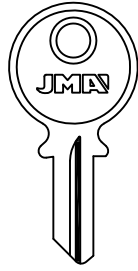

VA-9D

RUKA



VA-12D

TRELOCK

EE...9001-9100

VA-14D

VA-15

VACHETTE

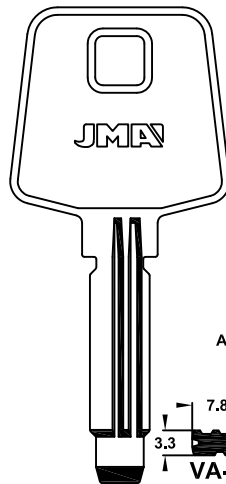
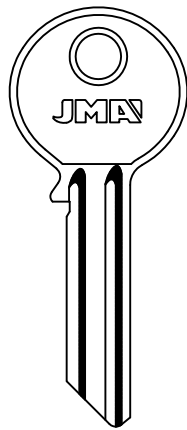

ALP.



VA-25

VA-24I

VA-24D

VA-26

RADIAL

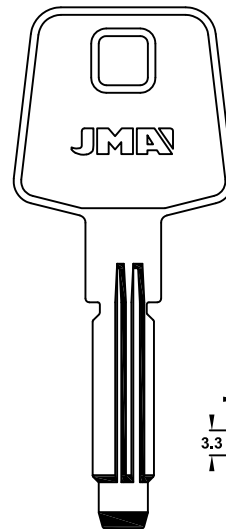

VA-27

VA-28

RADIAL

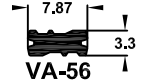

VA-56

ALP.

VACHETTE

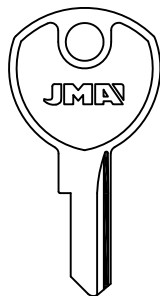

VL..A0-H9

VA-29

RL..A0-H9

VA-35

DAD-JU

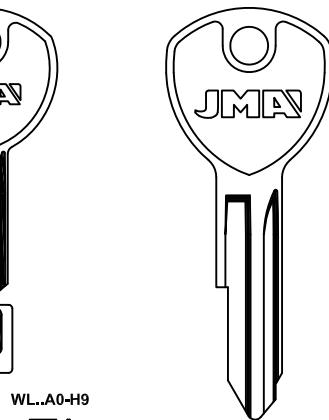

WL..A0-H9

VA-29D

K..A0-H9

BL..A0-H9

VA-35D

VA-30

VA-62

VA-62D

VINCO

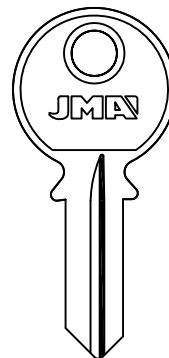

40-50-60

.....

1 AL 8

VA-31D

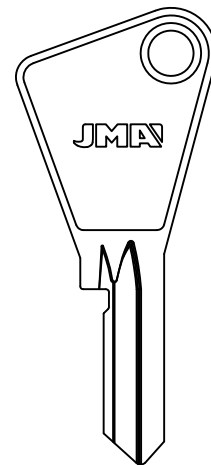

AY...0-249

Y...0-249

VA-32D

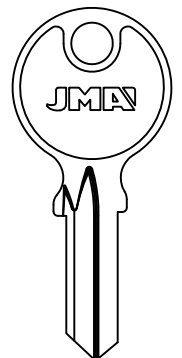

VA-33D



VACHETTE

PARA-FOR:
VACHETTE (F)

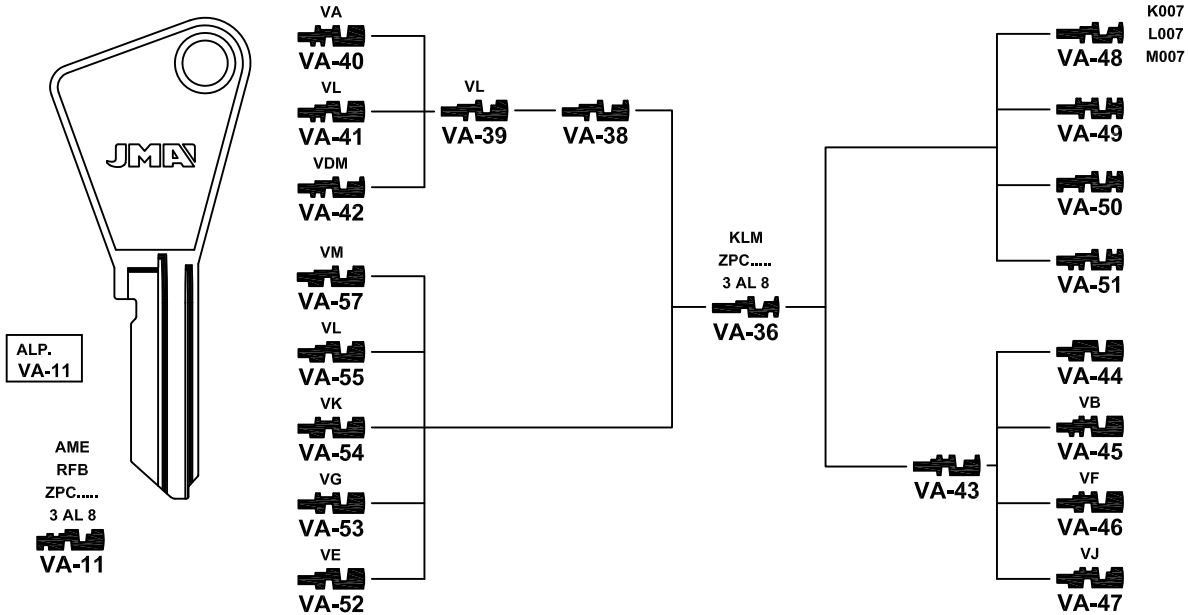

VACHETTE

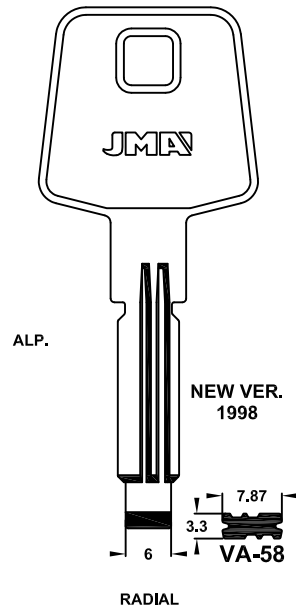
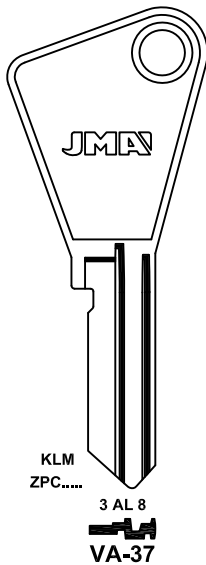

VACHETTE

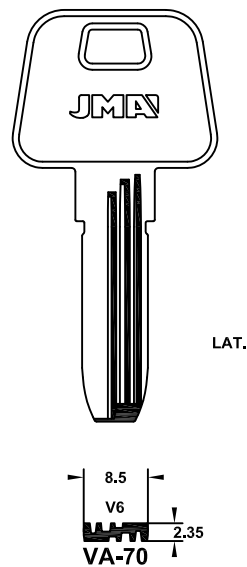
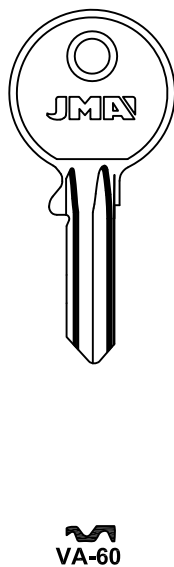
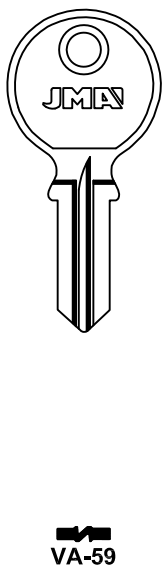

PARA-FOR:

- VARIOS
- VBH (D)
- VEGA (F)
- VENDI (RO)

VARIOS

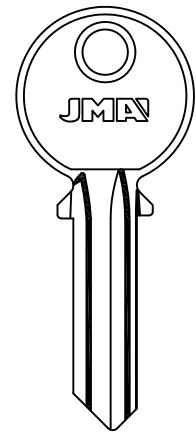
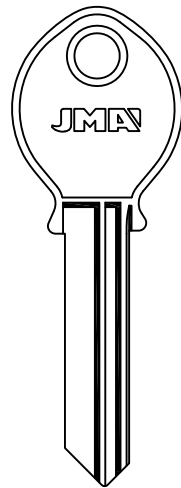
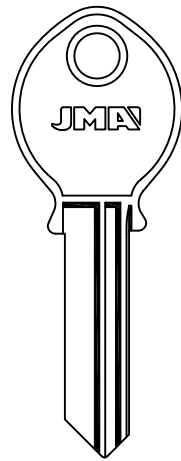

FAC

VARIOS

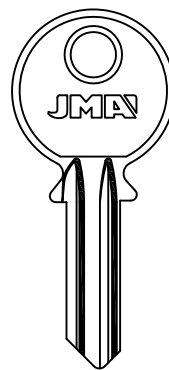
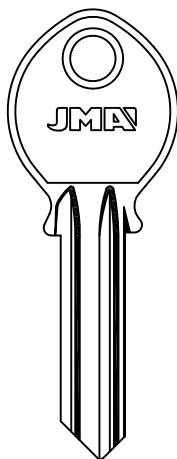
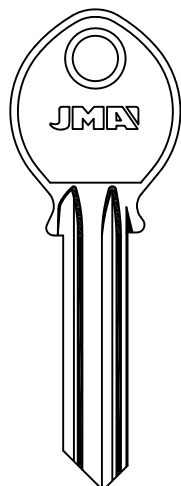

RONEO-JCEM



BOMORO

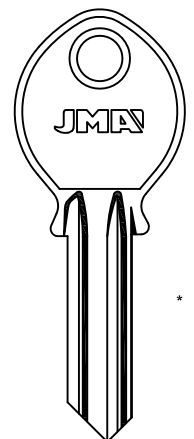

* LAT.
ALU.

VBH

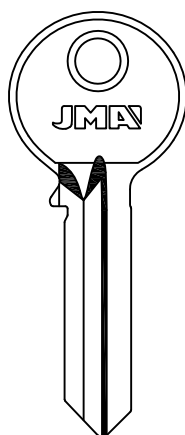
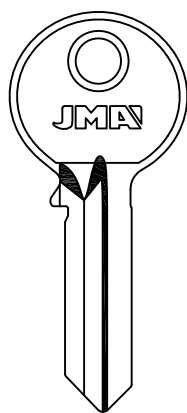



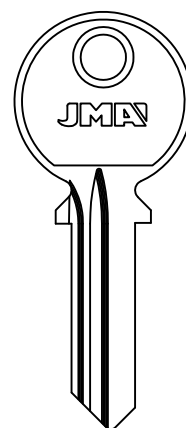



VEGA

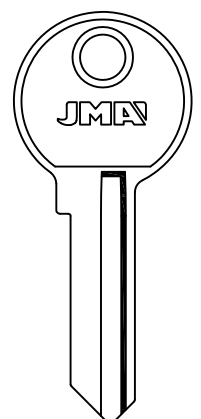

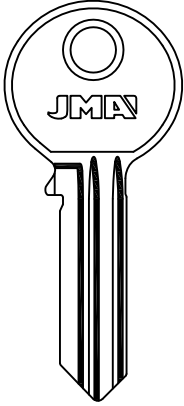
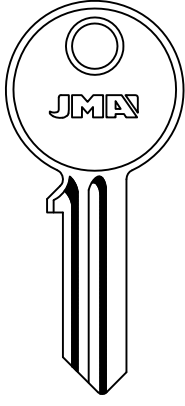
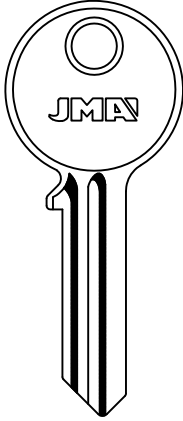
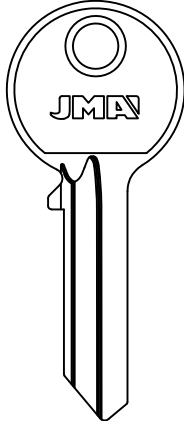
VACHETTE









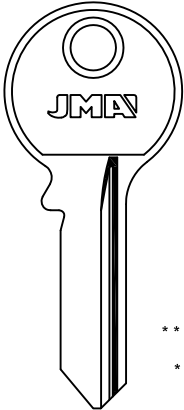
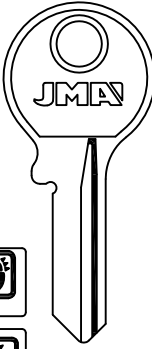
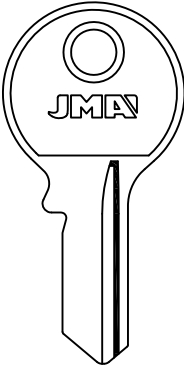

VENDI











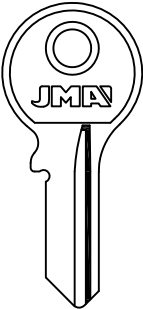
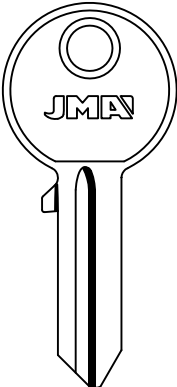
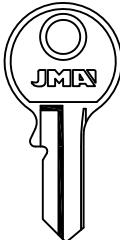
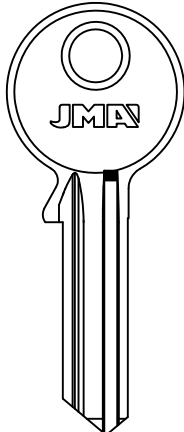

VENDI	VGF VILLATORE		VING
			
 VND-3	 VGF-4I	 VGF-4D	 VIN-1D
	 VGF-5I	 VGF-5D	

PARA-FOR:
 VENDI (RO)
 VGF VILLATORE (I)
 VING (N)
 VIRO (I)

VIRO

		
** ALU. * LAT.	** ALU. * LAT.	
 * VI-1I	 VI-7	 ** VI-2I
 VI-1D	 VI-9D	 VI-2D
 * VI-12	 * VI-15	 VI-4I
	ABUS-BERAM-ROYAL-TESA	ABT

VIRO







			
  			
 VI-4IP	 VI-5D	 VI-6D	 VI-8
 VI-4DP		 VI-8D	
ABUS-ROYAL	ABT	ABUS-BURG	



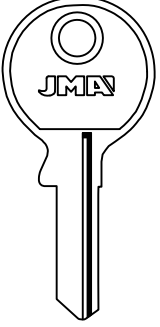
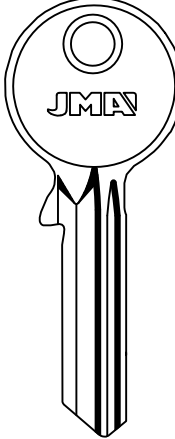
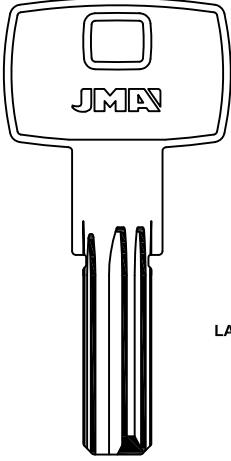
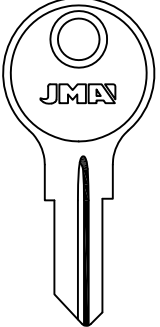



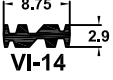



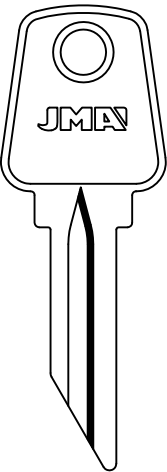
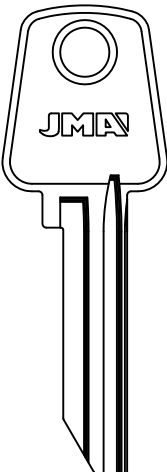
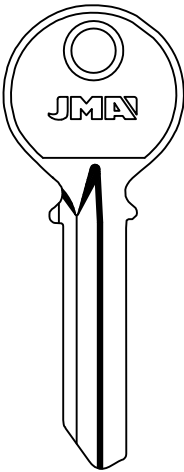

PARA-FOR:

- VIRO (I)
- VOLGOGRAD (RUS)
- VOLKOVYSK (RUS)
- WALLY (RC)
- WALRUS (RC)

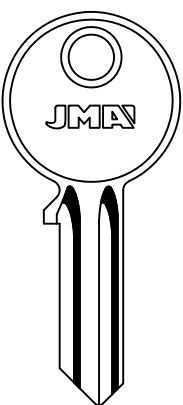
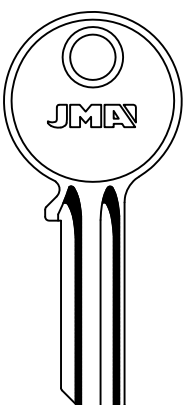
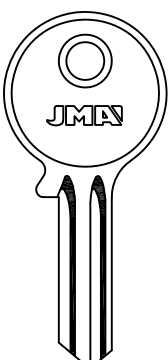
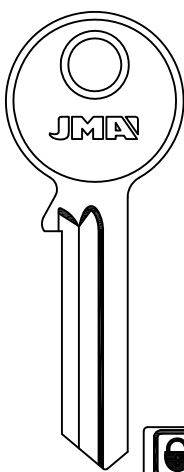





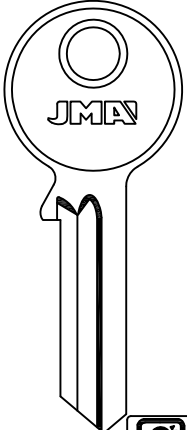

VIRO

			
	LAT.	LAT.	LAT.
	 TS 	 8.75 2.9 VI-14	
		EURO-PRO	FAI

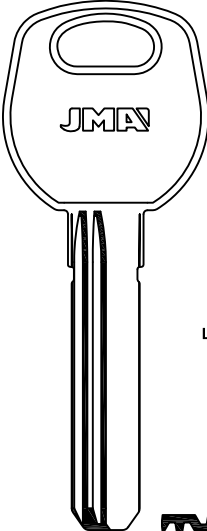
VOLGOGRAD	VOLKOVYSK	WALLY
		
		

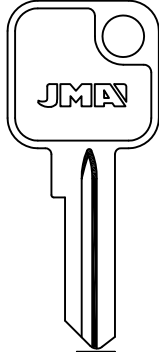

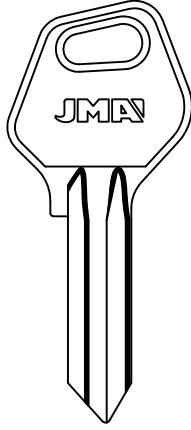





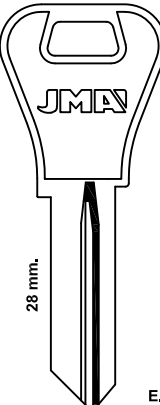

WALLY			WALRUS	
				
				
MOREAUX				

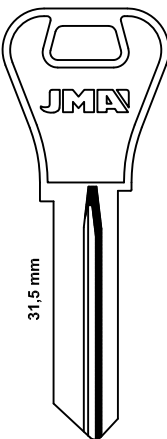

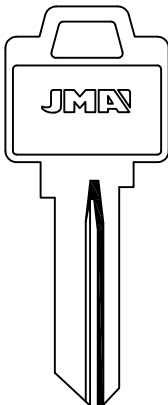

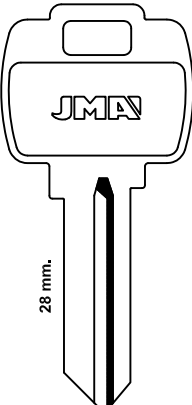

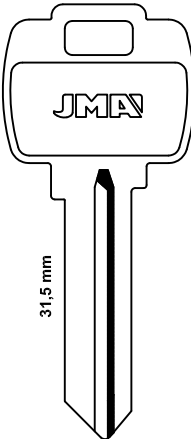





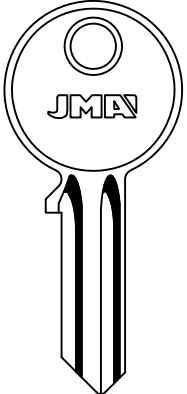

WALRUS	WANJIN	WEBER	WEBSTER
  WAL-2D	 LAT.  WAN-1D	 WEB-1  WEB-2  WEB-3 WECO	  WBS-1

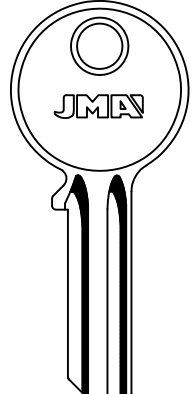
PARA-FOR:
 WALRUS (RC)
 WANJIN (PRC)
 WEBER (D)
 WEBSTER (GB)
 WEISER (USA)
 WELKA (I)
 WESLOCK (USA)

WEISER

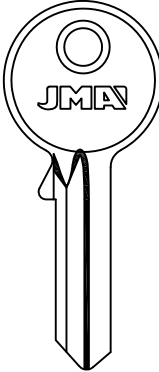
 28 mm.  WEI-1  WEI-6 KAWE	 31,5 mm  WEI-2 FALCON-FICHET	  WEI-3 IDEAL SECURITY	 28 mm.  WEI-4 FALCON	 31,5 mm  WEI-5 FALCON
--	--	--	--	---

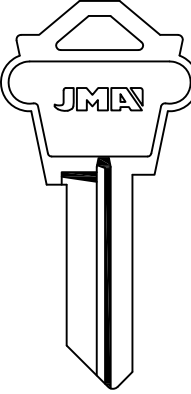
WELKA	WESLOCK
-------	---------

  WE-4I	  WE-4D	  WE-5I	  WE-5D	  WE-6D	  WES-1D
---	--	--	--	--	---



PARA-FOR:

WESTLOCK (USA)

WHITCO (AUS)

WILKA (D)

WEST LOCK		WHITCO	WILKA
V.... 1 AL 6 WST-1D	V.... 1 AL 6 WST-2D0123456789A WHI-1D 1 AL 9 WIL-1D
		LAT.	ALU.
			WIL-7 JORE-WIGRO

WILKA

 WIL-2D	 WIL-3D 1 AL 9 WIL-4D 1 AL 9 WIL-5 1 AL 9 WIL-5D
	CFP-GBS	JORE-WIGRO		
		MTIC.		

WILKA

	* WIL-26	* WIL-33D	* WIL-40D	* WIL-48D	* WIL-55	* WIL-62	
	* WIL-25	* WIL-32	* WIL-39D	* WIL-47D	* WIL-54	* WIL-61	
	W101 WIL-24	* WIL-31D	* WIL-38D	* WIL-46D	* WIL-53	* WIL-60D	
	WIL-19D	* WIL-30	* WIL-37D	* WIL-45D	* WIL-52	* WIL-59D	
	* WIL-18	* WIL-29	* WIL-36D	* WIL-44	WIL-51D	* WIL-58D	
	* WIL-9	* WIL-28	* WIL-35D	* WIL-43D	* WIL-50D	* WIL-57D	WIL-65D
	WIL-8	* WIL-27	* WIL-34D	* WIL-41D	* WIL-49D	* WIL-56	* WIL-63D

* LAT.



WILKA

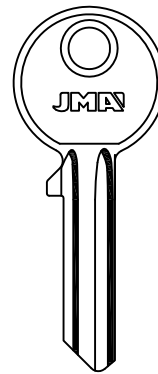
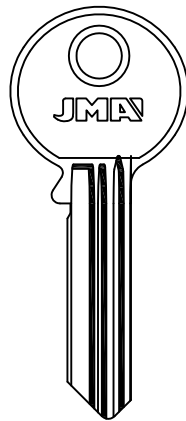
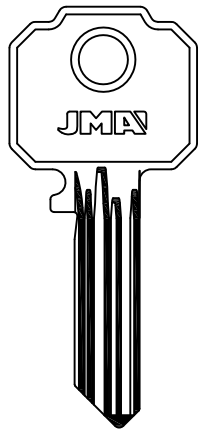

PARA-FOR:
 WILKA (D)
 WINDHAUS (D)
 WINLOCK (GB)
 WIREROPE (HK)

WILKA

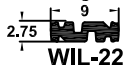
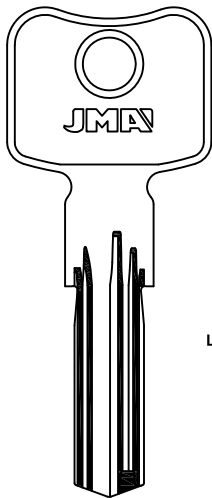

SERIE 3600

WINKHAUS

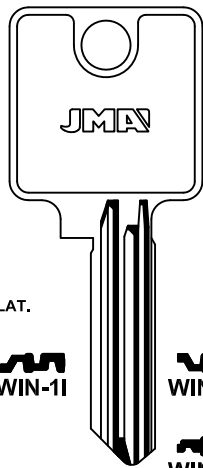

LAT.

ALP.

LAT.



AZBE

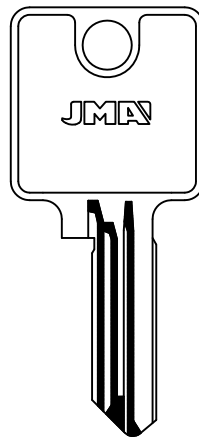

ALP.

AZBE

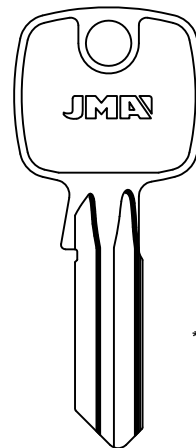

* ALP.
ACE.



WINKHAUS

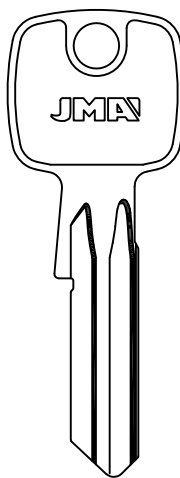
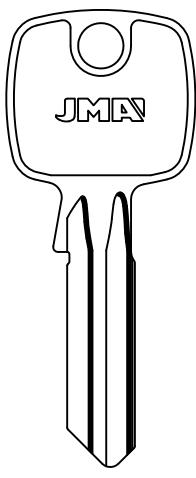
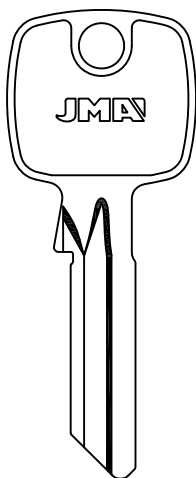

WINLOCK

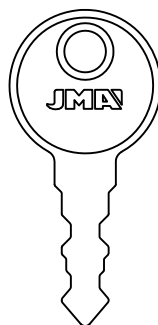

WIREROPE

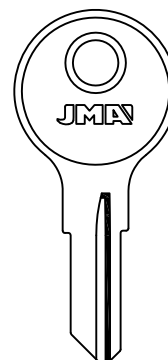

PARA-FOR:

WMS (GB)
 WT (TJ)
 YALE
 (D-GB-USA)

WMS

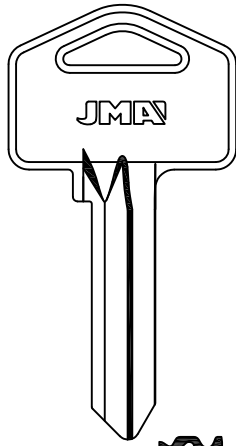

WM-1D

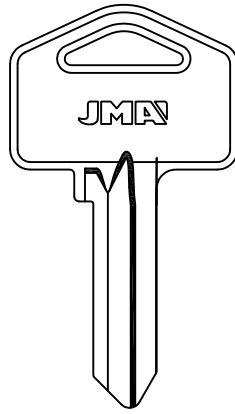

WM-2D

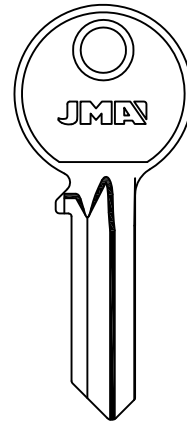

WM-3D

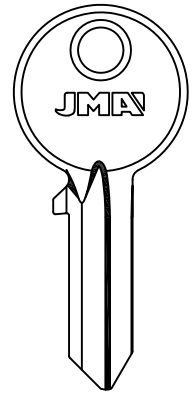

WM-4D

WM-5D

I.R.-TITUS

WT

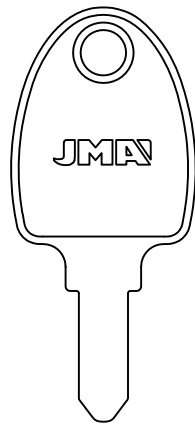

WT-1

LAT.

YALE

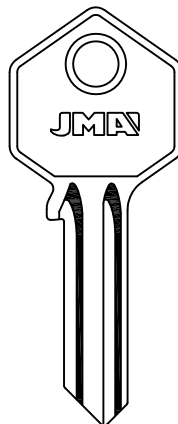

YA-1I YA-1D
0 AL 9

YA-32D

WALE

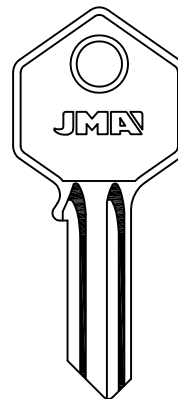

YA-2I YA-2D
0 AL 9

ALU.

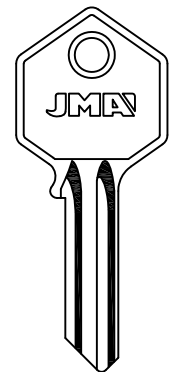

YA-3I YA-3D
0 AL 9

WALE

YALE

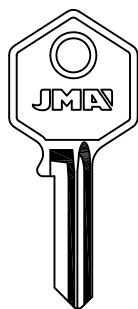

YA-5I YA-5D

MIGNON

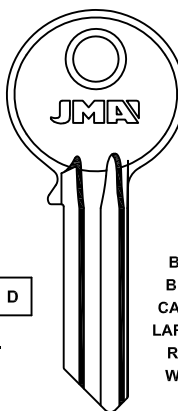

YA-6I YA-6D
0 AL 9

ALU.

BKS
 BIRD
 CARAT
 LAREDO
 ROC
 WOC

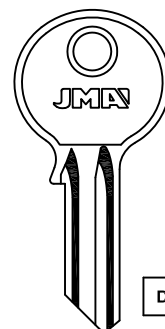

YA-7I YA-7D
 R..101-150
 SX...1-1000
 VR...1-4000
 BX...1-500
 YA-16D

D GB

BKS-WECO

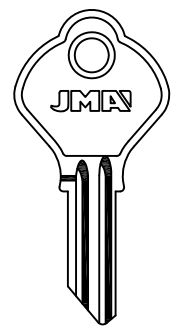

YA-8I YA-8D
 DC...551-952

GB



YALE

PARA-FOR:

YALE
(D-GB-USA)

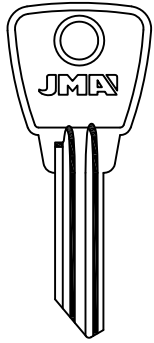

GB



LT...1-100
LC...1-100

YA-10 YA-10D

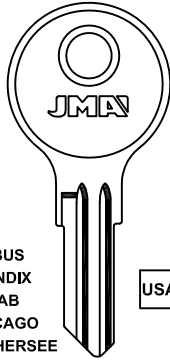

ABUS
BENDIX
CAB
CHICAGO
COLE HERSEE

USA GB

ALU.

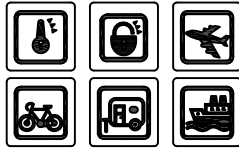

YA-111 YA-11D

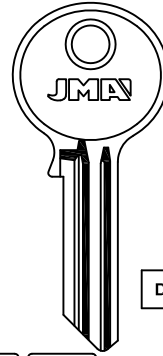

D GB



ABG...
7537-8336

YA-12I YA-12D

YA-13I YA-13D

BKS

YALE

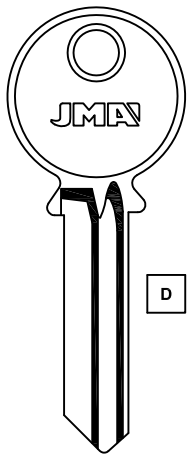

D GB

YA-17I

YA-17D

YA-26I

YA-29

PBS
YA-39

Y
YA-14I

L
YA-14D

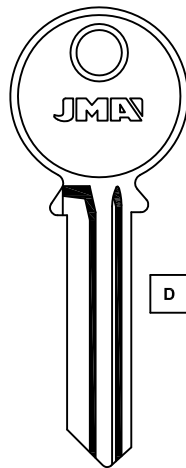

D GB

Y
YA-15I

L
YA-15D

ALU.

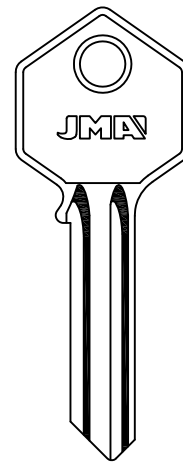

.....0 AL 9
YA-22I YA-22D

YALE

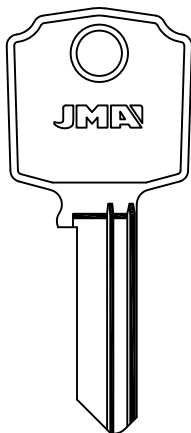

ALP.

ALU.

* FSH.

YA-23

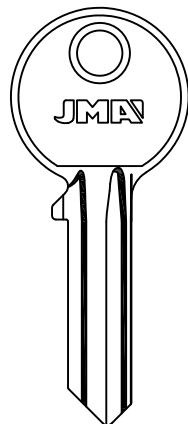

GB

.....0 AL 9

YA-24I * YA-24D

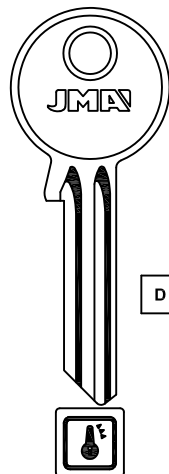

D GB

YA-25I

YA-25D

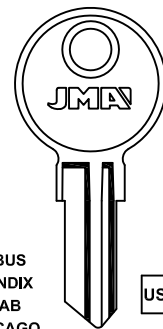

ABUS
BENDIX
CAB
CHICAGO
COLE HERSEE

USA GB



...500-550

YA-27

YA-27D



PARA-FOR:

YALE
(D-GB-USA)

YALE

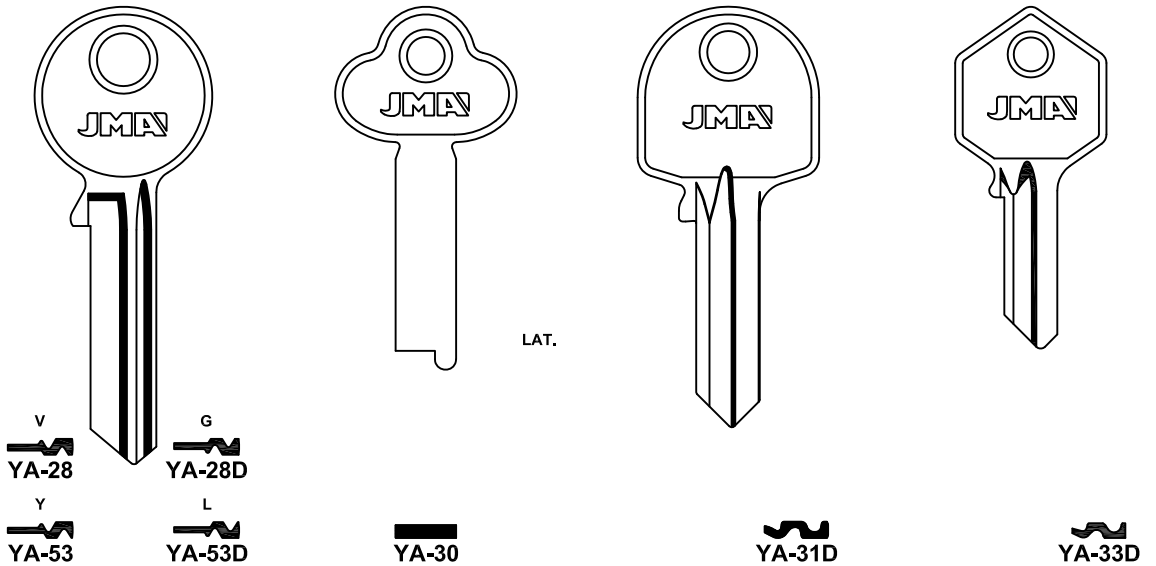

YALE

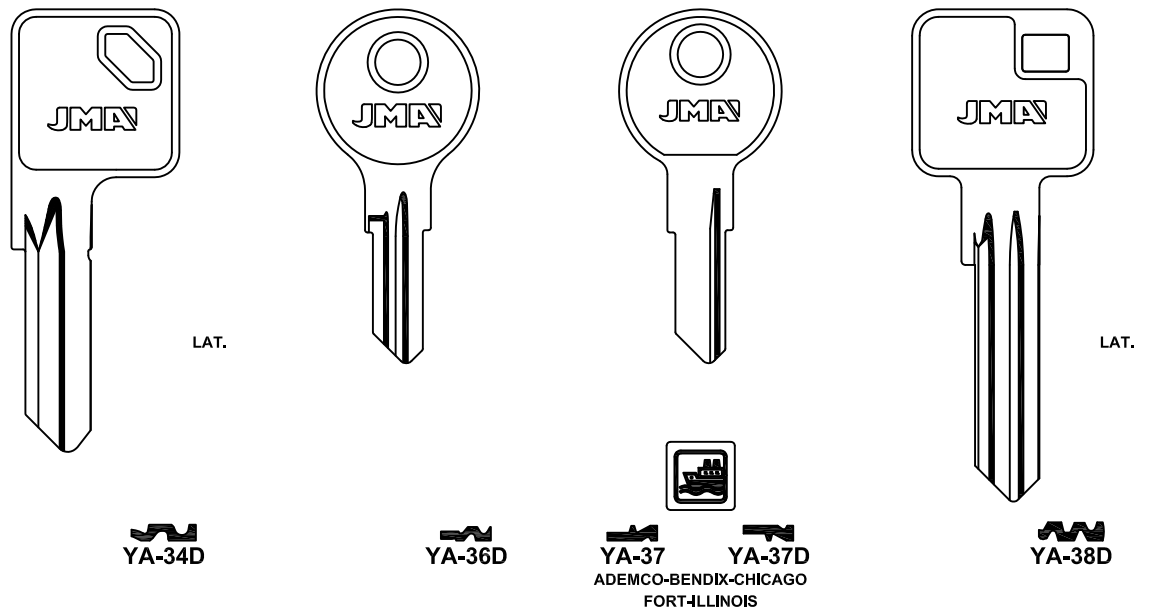

YALE

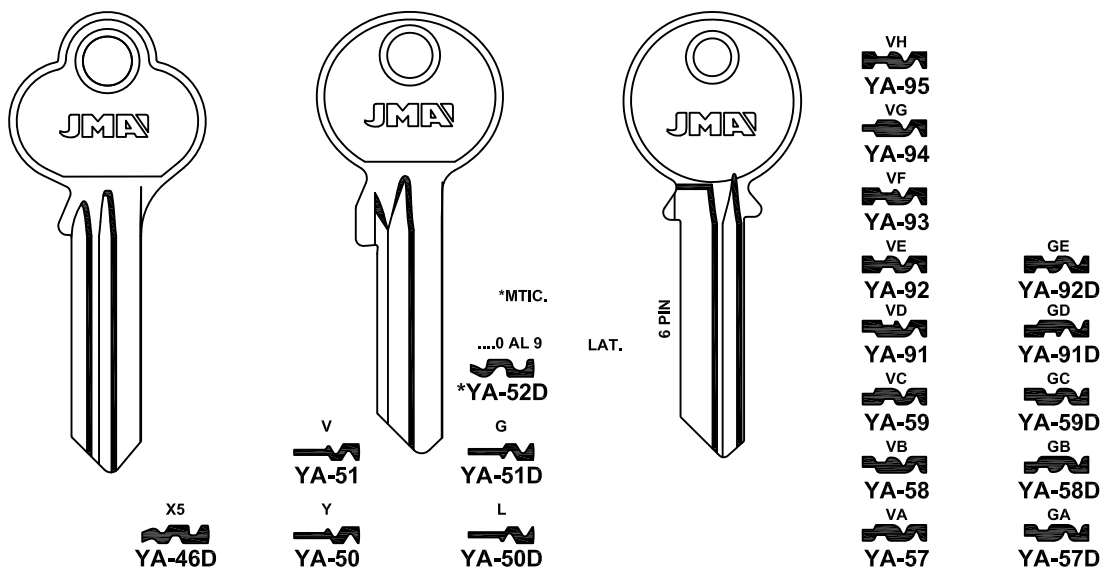

YALE

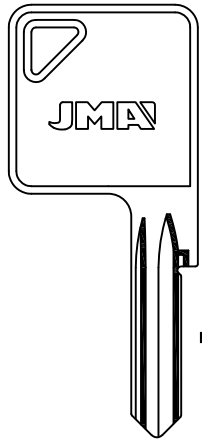

YA-72

DRAPER

LAT.

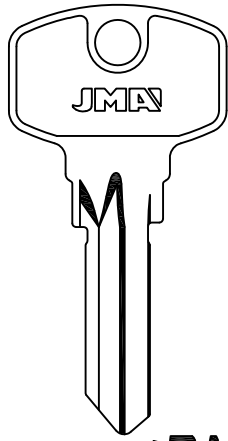

YA-79D

YA-272D

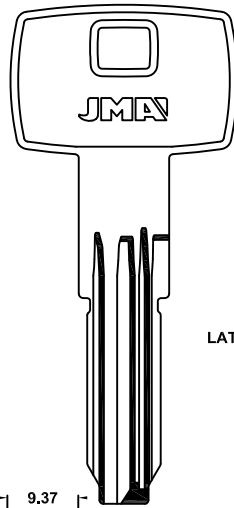

YA-81

LAT.

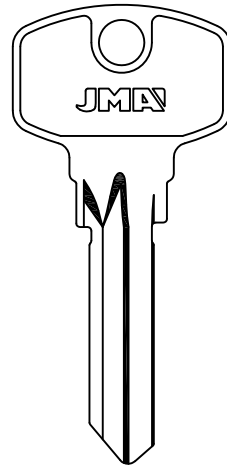

YA-85D

PARA-FOR:

YALE
(D-GB-USA)

YALE

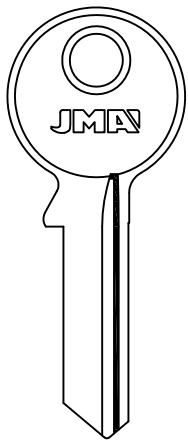

YA-88

ASSA ABLOY

RSA

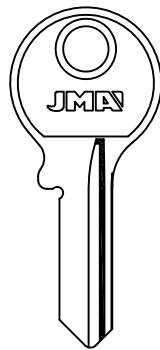

YA-89

ASSA ABLOY

RSA

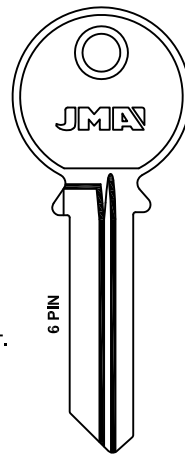

LAT.

6 PIN

LG
YA-103D

LF
YA-102D

LE
YA-101D

LD
YA-100D

LC
YA-99D

LB
YA-98D

LA
YA-97D

YALE

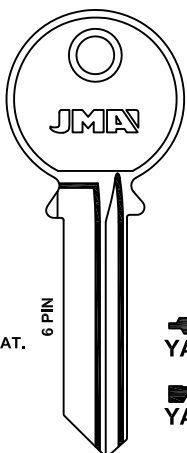

LAT.

6 PIN

YG
YA-113

YF
YA-112

YE
YA-111

YB
YA-108

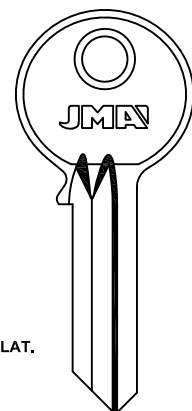

LAT.

YA-142D

BKS

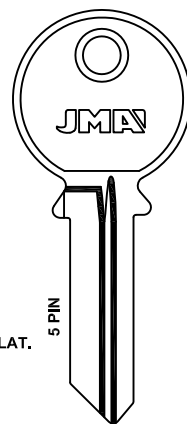

LAT.

5 PIN

GA
YA-186D

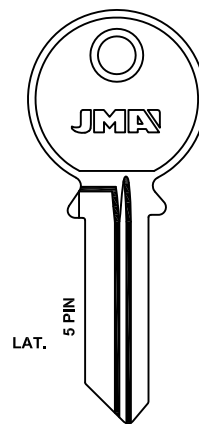

LAT.

5 PIN

LG
YA-212D

LE
YA-210D

LD
YA-209D

LC
YA-208D

LA
YA-206D



PARA-FOR:

YALE
(D-GB-USA)
YARDENI (IL)
YETI (RC)

YALE

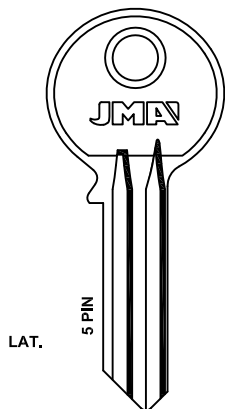

LAT.

- VF
YA-221
- VE
YA-220
- VD
YA-219
- VB
YA-217
- VA
YA-216

BKS

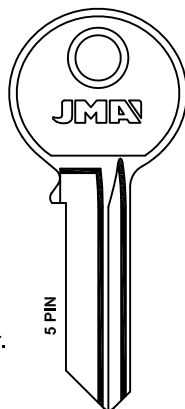

LAT.

- YH
YA-232
- YE
YA-229
- YD
YA-228
- YC
YA-227
- YB
YA-226
- YA
YA-225

BKS

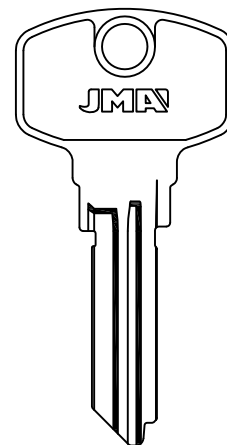

- KTM
YA-273D

YARDENI

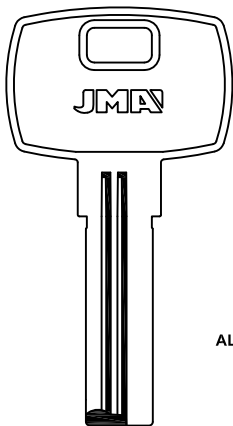

ALP.

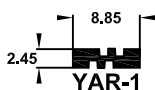

YAR-1

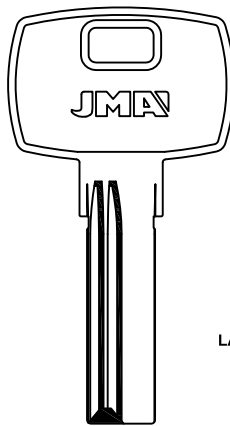

LAT.



YAR-2

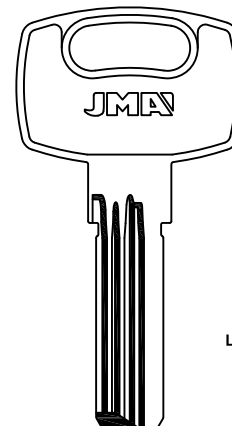

LAT.



YAR-3

YETI

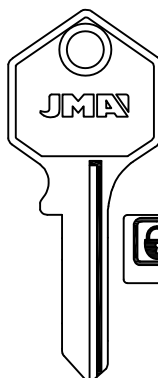

- AKIRA
- ASIA
- BELL
- DEHA
- FOUR CIRCLE
- HAIDE
- HEMY
- HERMES
- HEAD
- LOTUS
- RAM
- ROYAL
- SANCHUN
- SWAN
- VELO
- VISO
- WINFIELD
- SEZAN



YET-1



YET-1D

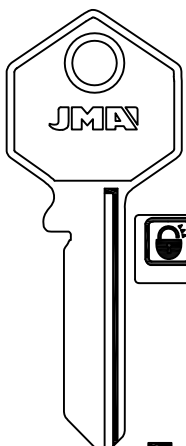

- AKIRA
- ASIA
- BELL
- DEHA
- FOUR CIRCLE
- HAIDE
- HEMY
- HERMES
- HEAD
- LOTUS
- RAM
- ROYAL
- SANCHUN
- SWAN
- VELO
- VISO
- WINFIELD
- SEZAN



YET-2



YET-2D

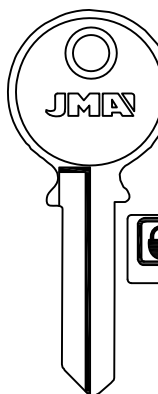

- AKIRA
- ASIA
- BELL
- DEHA
- FOUR CIRCLE
- HAIDE
- HEMY
- HERMES
- HEAD
- LOTUS
- RAM
- ROYAL
- SANCHUN
- SWAN
- VELO
- VISO
- WINFIELD
- SEZAN



YET-3D



YET-15

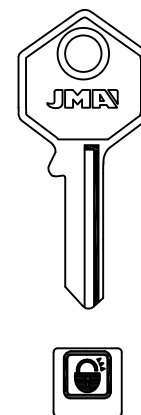

- AKIRA
- ASIA
- BELL
- DEHA
- FOUR CIRCLE
- HAIDE
- HEMY
- HERMES
- HEAD
- LOTUS
- RAM
- ROYAL
- SANCHUN
- SWAN
- VELO
- VISO
- WINFIELD
- SEZAN



YET-4



YET-4D



YETI

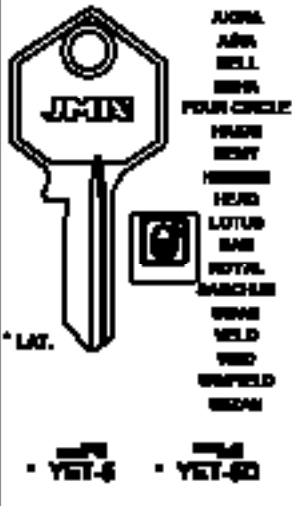

ACMA
AJA
BLL
BWA
FOUR CIRCLE
HANE
HEBY
HEPHE
HEAD
LOTUS
BAM
ROYAL
SARGHER
SWAN
VELD
VHO
WHPFLD
WEGAN

YET-6

YET-6D



ACMA
AJA
BLL
BWA
FOUR CIRCLE
HANE
HEBY
HEPHE
HEAD
LOTUS
BAM
ROYAL
SARGHER
SWAN
VELD
VHO
WHPFLD
WEGAN

YET-7

YET-7D

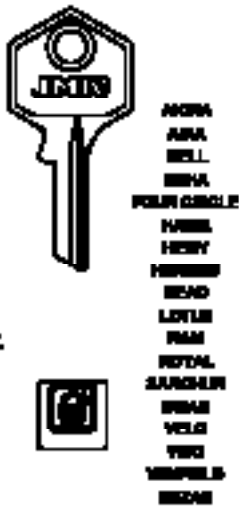

ACMA
AJA
BLL
BWA
FOUR CIRCLE
HANE
HEBY
HEPHE
HEAD
LOTUS
BAM
ROYAL
SARGHER
SWAN
VELD
VHO
WHPFLD
WEGAN

YET-4

YET-4D

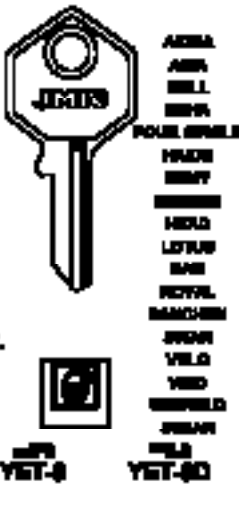

ACMA
AJA
BLL
BWA
FOUR CIRCLE
HANE
HEBY
HEPHE
HEAD
LOTUS
BAM
ROYAL
SARGHER
SWAN
VELD
VHO
WHPFLD
WEGAN

YET-13

PARA-FOR:
YETI (RC)
YUN HUAN (PRC)
YMS (TW)
ZADI (I)

YETI

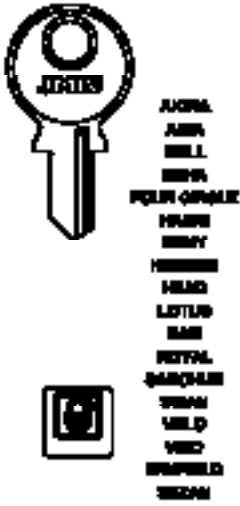

ACMA
AJA
BLL
BWA
FOUR CIRCLE
HANE
HEBY
HEPHE
HEAD
LOTUS
BAM
ROYAL
SARGHER
SWAN
VELD
VHO
WHPFLD
WEGAN

YET-10

YET-10D



ACMA
AJA
BLL
BWA
FOUR CIRCLE
HANE
HEBY
HEPHE
HEAD
LOTUS
BAM
ROYAL
SARGHER
SWAN
VELD
VHO
WHPFLD
WEGAN

YET-11

YET-11D

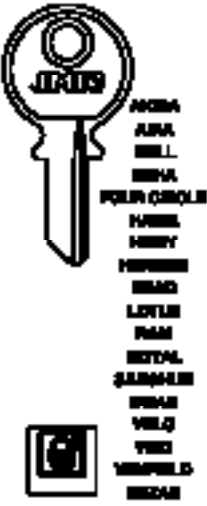

ACMA
AJA
BLL
BWA
FOUR CIRCLE
HANE
HEBY
HEPHE
HEAD
LOTUS
BAM
ROYAL
SARGHER
SWAN
VELD
VHO
WHPFLD
WEGAN

YET-12



YET-17D

LOW-COPYING-PROHIBITED

YUN HUAN



YUH-10



YUH-20

YWS



YW-1F

ZADI



ZA-1



PARA-FOR:

ZADI (I)

ZENI (GB)

ZADI

ZENI

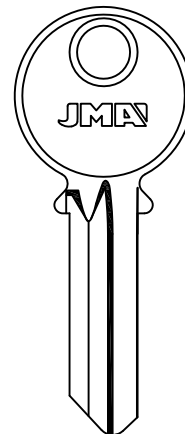
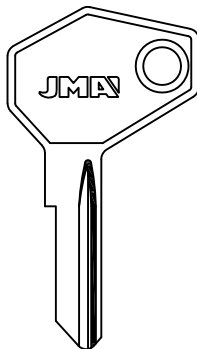
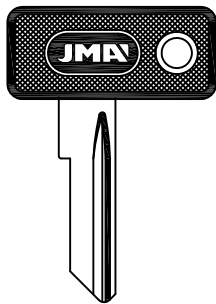

....1-1625
....5001-6278
E...1-710

....1-1625
....5001-6278
E...1-710



ZA-1.P

BRETER



ZA-12

BRETER



ZEN-1D



LLAVES PARA VEHÍCULOS

IBILGAILUENTZAKO GILTZAK

KEYS FOR VEHICLES

CLES POUR VEHICULES

FAHRZAUGESCHLÜSSEL



THE KEY TO EXCELLENCE

GLOBALLY UNLOCKING MILLIONS OF DOORS DAILY

PARA-FOR:

ABSA (E)

ABUS (D)

ABSA

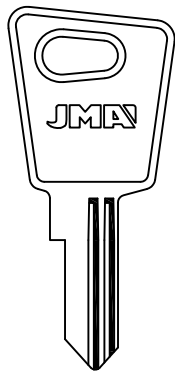

M.LUNA

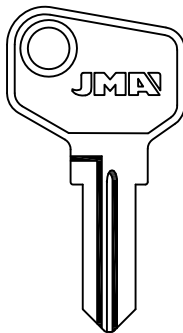

PROAUTO

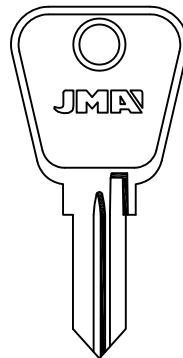

FROSER

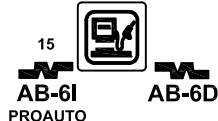
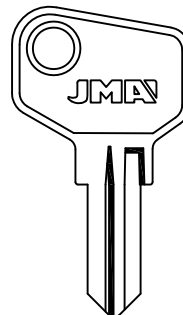

ARFE-FROSER-KEYA

ABSA

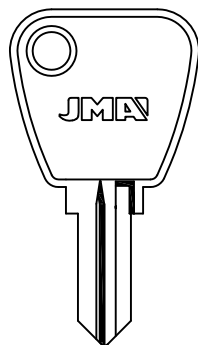

AB-10I

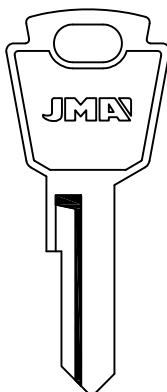

8



SIM-1200

ABUS

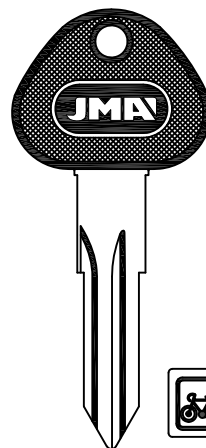

Z71...1-1043
Z72...1-1043



ABU-18.P

ABU-18D.P

BUFFO

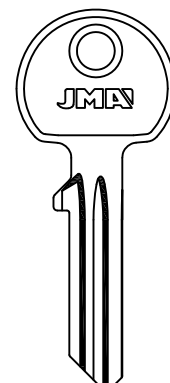

Z71...1-1043
Z72...1-1043

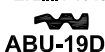

ABU-19D

BUFFO

ABUS

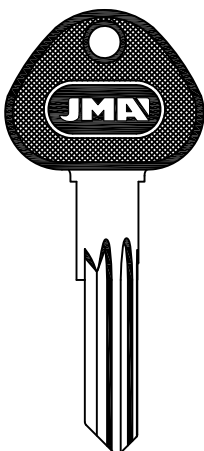

ABU-19.P

BUFFO

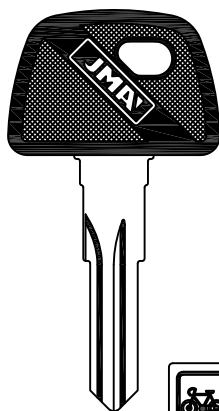

X61...
X62...



ABU-35.P

BUFFO

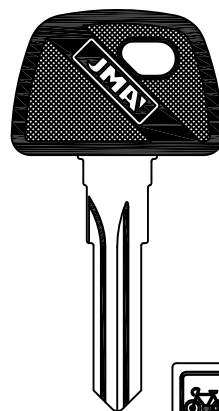

ABU-64.P

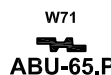



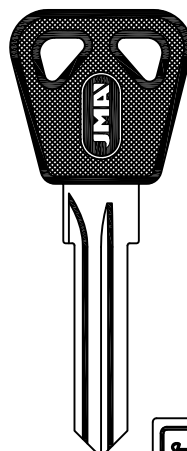





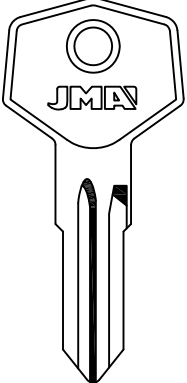

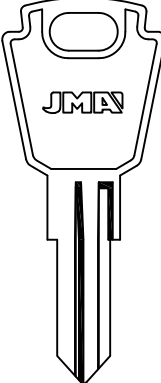
ABU-65.P

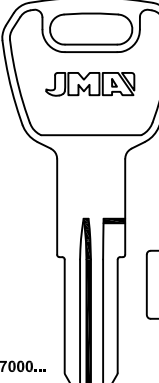



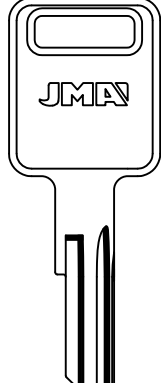







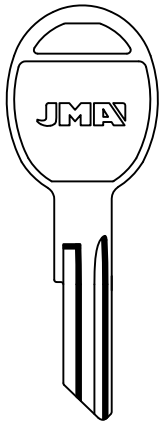

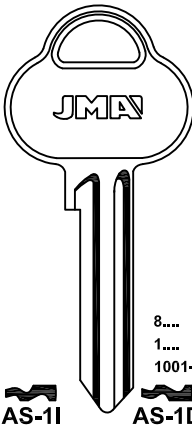
ABU-72.P



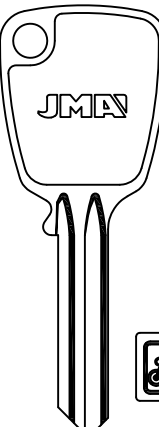



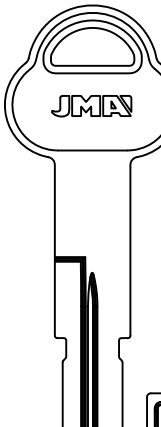



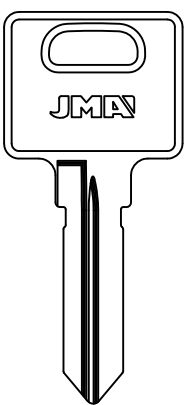

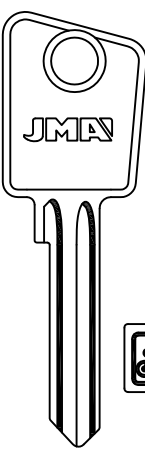
AKS	ALPHA		AMERICAN MO.
 <p>KA 001-100  AKS-1 VOLVO</p>	 <p>S...301-600   ALP-1I ALP-1D FEB</p>	 <p>7000...   ALP-2 ALP-2D JD-LINCE-MONACOR SANY-VISONIC S...301-600   ALP-6 ALP-6D FEB</p>	 <p>LAT.  AMM-1</p>

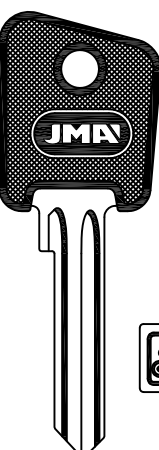
PARA-FOR:

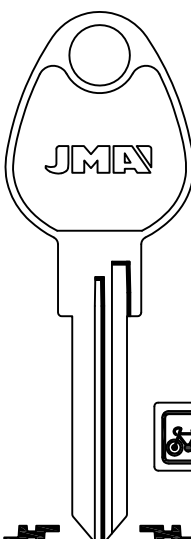
- AKS (D)
- ALPHA (J)
- AMERICAN MOTORS (USA)
- ASSA (S)
- AXA (S)

AMERICAN MO.	ASSA		
 <p>LAT.  AMM-2</p>	 <p>8... 1... 1001-3300   AS-1I AS-1D 7... 6... 1001-3300   AS-24 AS-24D SAAB-VOLVO</p>	 <p> 700-7999 6000-8999   AS-2I AS-2D</p>	 <p> 21... 0001-9999  AS-17D BICICLETTA CYCLES</p>

ASSA		AXA
 <p>21... 0001-9999  AS-19D</p>	 <p>7000-7999 8000-9999 A... A... 7000-7999 9000-9999   AS-21 AS-21D</p>	 <p>7000-7999 8000-9999 A... A... 7000-7999 9000-9999   AS-21.P AS-21D.P</p>
		 <p>   AX-1 AX-1D</p>



PARA-FOR:

AXA (S)

AZU (E)

BASCO (USA)

BLAU (D)

AXA

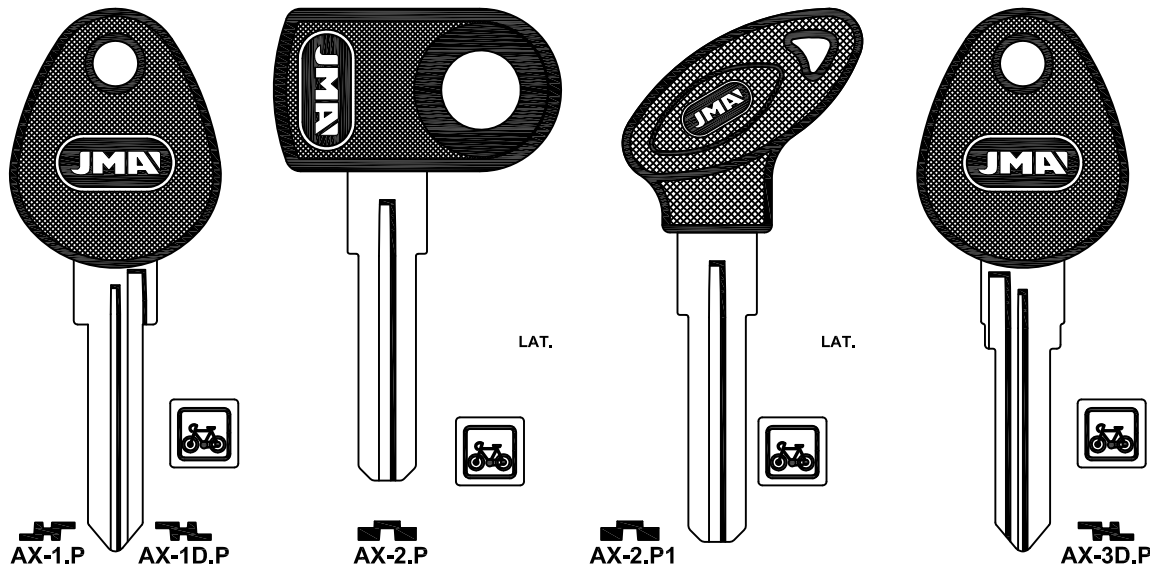

AXA

AZU

BASCO

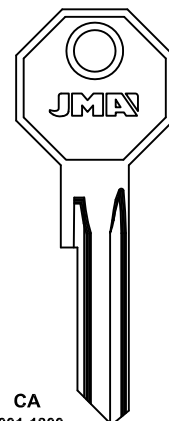
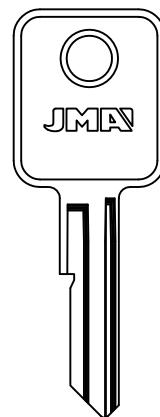
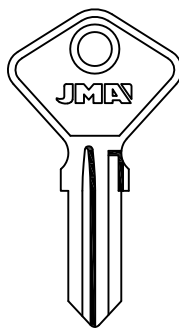
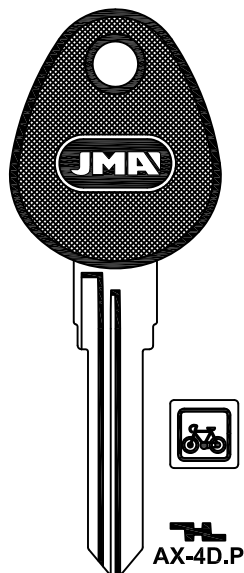

E,D
225-814
K
0001-1000
8000-9499
GENERAL MOTORS-HOLDEN
CORBIN

CA
0001-1800
BAS-2I
BAS-2D
D,C,P,D
BAS-3
CORBIN-YALE

DKW

BASCO

BLAU

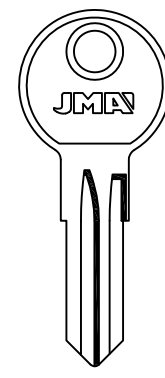
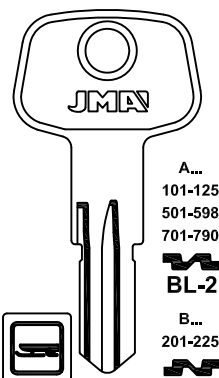
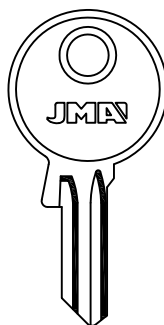
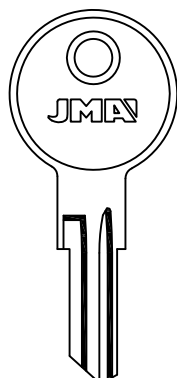

AMERICAN M.-B&S-CHICAGO C.
ELMO-HERSEE E.-ILLINOIS-YALE

EMOH
FLORA
KN
LINDE
POS
WESCO
33-54
31-86
BL-1I
BL-1D

A...
101-125
501-598
701-790
BL-2
B...
201-225
BL-3
A
BL-4
A 201-225
BL-6
BL-4D
B 101-125
BL-6D

1-200
RE...1-200
BL-5
BL-5D

FORT-HK-WASO



BOMBARDIER

BOMORO

BOSCH

PARA-FOR:

- BOMBARDIER (USA)
- BOMORO (D)
- BOSCH (D)
- BRABANTIA (E)
- B.&S. (USA)

LAT.

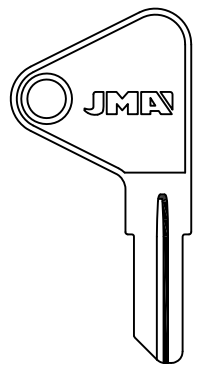

BOB-1D

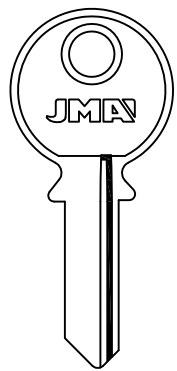

BOM-2 BOM-2D

LAPORTE-PRESTA

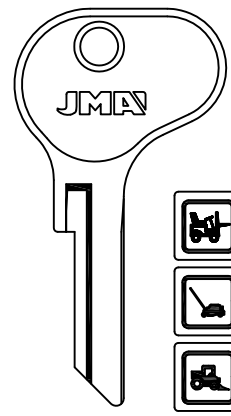

E, M, N, U, H, K
001-100
HG, N 140-189
HG 040-100

BH-1

NEIMAN

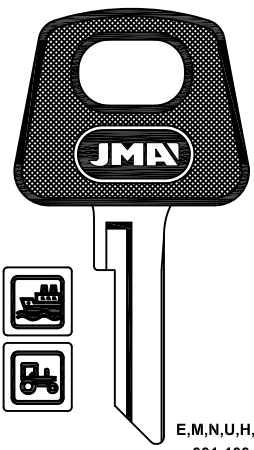

E, M, N, U, H, K
001-100
HG, N 140-189
HG 040-100

BH-1.P

NEIMAN

BOSCH

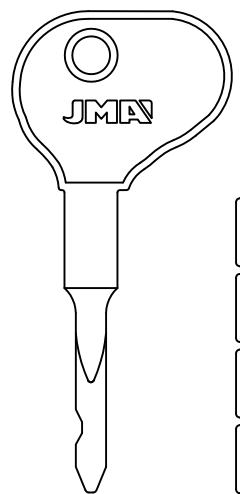

BH-2

FIAT IVECO-MACK M-SCANIA

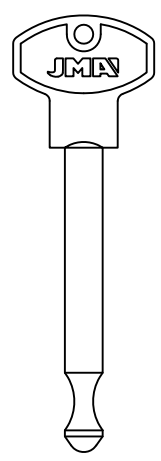

BH-3

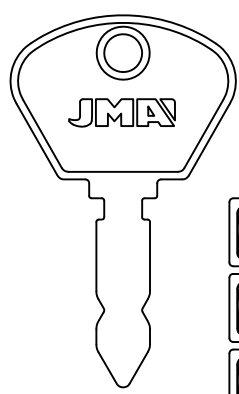

7,1 1,95
BH-4

DISALCAR-OM IVECO-SULKY
KOLB-POLAR

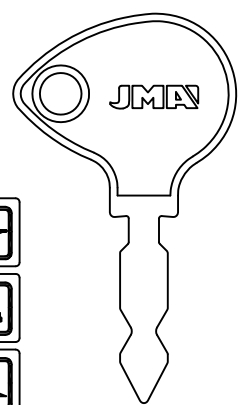

6,3 2
BH-5

BOSCH

BRABANTIA

B & S

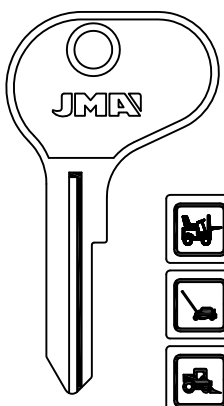

BH-6

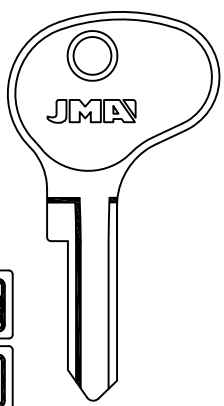

MS-S
1-50
BH-8

KOLB-LAPORTE

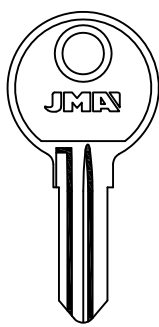

BRA-2

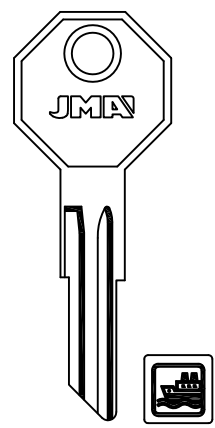

N
1501-1700
NA
001-200
BS-11

AMERICAN MOTORS-MACK
DEXTER



PARA-FOR:

- B.&S. (USA)
- BURG (D)
- CAMA (I)
- CASELLAS (E)
- CATERPILLAR (USA)
- CEM (GB)

BRIGGS & STRATTON

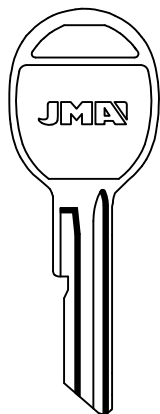

E...225-814
L...1-1000

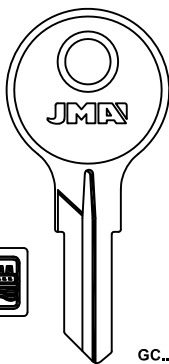

LAT.

A...250-1500
AP...250-1500
B...250-1500
C...1251-1700
CB...250-1500
DC-EP...250-699
P...250-1500

GC...
101-150
HC...
0-499

BS-4D

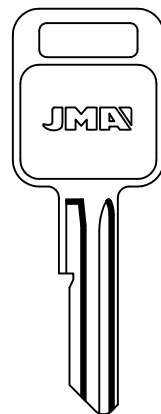

D
225-814
K
01-1000

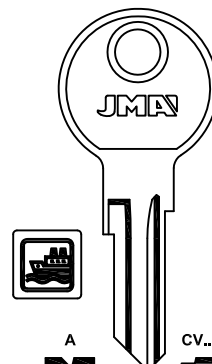

LAT.

* LAT. CV...1-1500

A
BS-7

D
BS-8

E
BS-9

* LAT. CV...1-1500

C
BS-7D

C
BS-8D

F
BS-9D

BURG

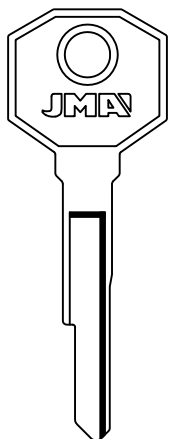

BUR-6

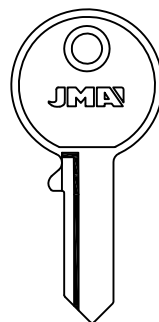

BUR-30D

MOFA

CAMA

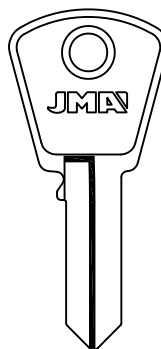

CAM-1D

FIST

CASELLAS

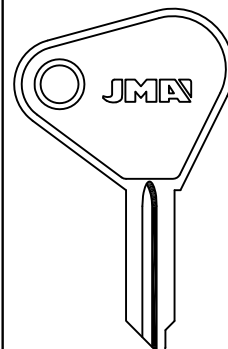

CAS-1D

OSSA

CATERPILLAR

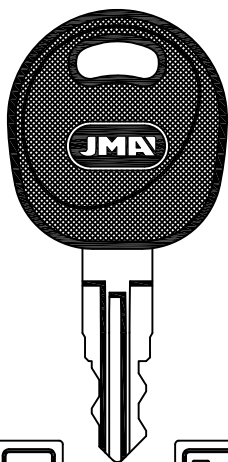

CAT-1.P

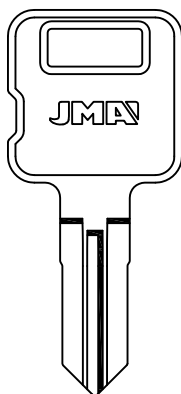

CAT-2

LAT.

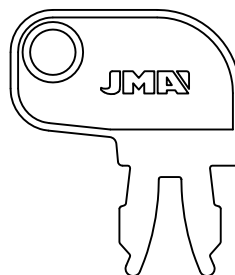

CAT-3

LAT.

CEM

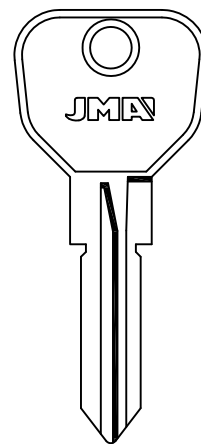

CEM-BP



CEM	CESSNA	CHRYSLER	
JC 001-852 CEM-JC DAIMLER-JAGUAR-ROVER-VOLVO	AK 0001-1000 500-999 CN-1D	 CHR-1 YALE	 CHR-2 ROSS

PARA-FOR:

- CEM (GB)
- CESSNA (USA)
- CHRYSLER (USA)

CHRYSLER			
.....A/Z B-C-D-E 1/9.....A/Z 1/9.....A/ZA/Z B-D-E-G-H-J .1/9.....A/Z .1/9.....A/Z E-M-N-P-R CHR-3 CLAUSOR-NEIMAN	A.MOTORS CITROEN MAZDA PEUGEOT RENAULT TALBOT DAF NISSAN PEGASOA/Z B-C-D-E 1/9.....A/Z 1/9.....A/ZA/Z B-D-E-G-H-J .1/9.....A/Z .1/9.....A/Z E-M-N-P-R CHR-3.P CLAUSOR-NEIMAN	A.MOTORS CITROEN MAZDA PEUGEOT RENAULT TALBOT DAF NISSAN PEGASOA/Z B-C-D-E 1/9.....A/Z 1/9.....A/ZA/Z B-D-E-G-H-J .1/9.....A/Z .1/9.....A/Z E-M-N-P-R CHR-5 NISSAN-PEGASO ROSS	Z 001-224 CHR-6 KIFERM-PJ
			W 001-224 CHR-6D

CHRYSLER			
CJ 001-500 DP 0001-1400 EP 0001-3000 CHR-7 CHRYSLER YALE	DP 0001-1400 EP 0001-3000 CHR-8 YALE	CJ 001-500 DP 0001-1400 EP 0001-3000 CHR-7.P CHRYSLER YALE	DP 0001-1400 EP 0001-3000 CHR-8.P YALE
		F.... G.... 0000-1394 CHR-9 AMERICAN MOTORS-CHRYSLER-JEEP YALE	F.... G.... 0000-1394 CHR-9.P AMERICAN MOTORS-CHRYSLER-JEEP YALE



PARA-FOR:

CHRYSLER
(USA)

CLAUSOR (E)

CHRYSLER

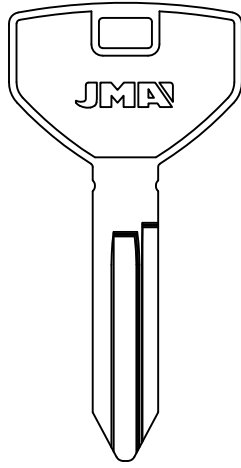

J....
0001-3580



CHR-10
AMERICAN MOTORS-CHRYSLER-JEEP
YALE

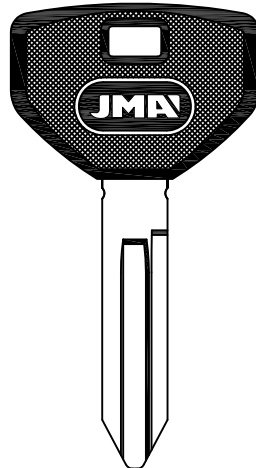

J....
0001-3580



CHR-10.P
AMERICAN MOTORS-CHRYSLER-JEEP
YALE

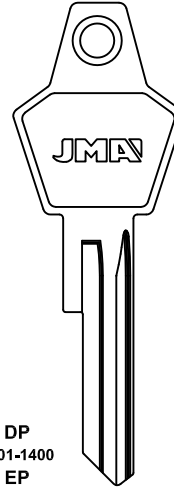

DP
0001-1400
EP
0001-3000



CHR-11
CHRYSLER
YALE

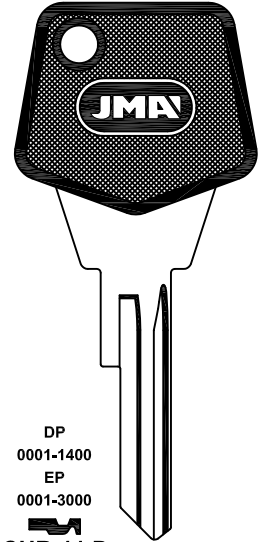

DP
0001-1400
EP
0001-3000



CHR-11.P
CHRYSLER
YALE

CHRYSLER

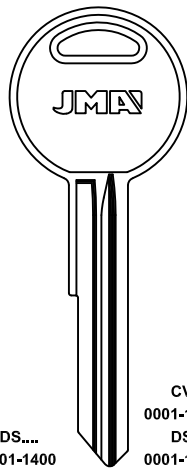

DS....
0001-1400
ES....
0001-3000



CHR-12
CHRYSLER

BRIGGS & STRATTON

CV
0001-1500
DS
0001-1500
ES
0001-1500



CHR-13D
CHRYSLER

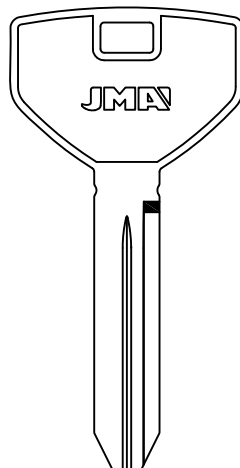

L.... 1-3580



CHR-14
CHRYSLER

BRIGGS & STRATTON-YALE

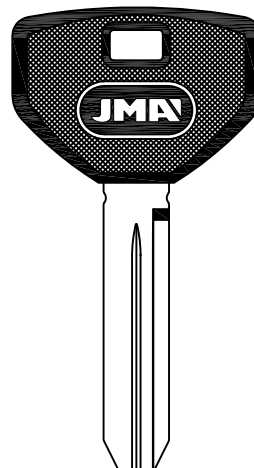

L.... 1-3580



CHR-14.P
CHRYSLER

BRIGGS & STRATTON-YALE

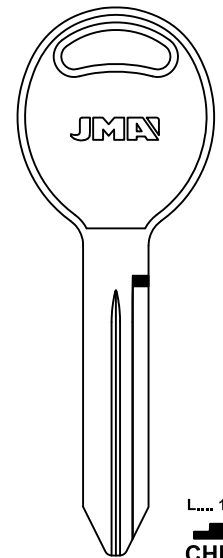

L.... 1-3580



CHR-15
CHRYSLER

BRIGGS & STRATTON-YALE

CHRYSLER

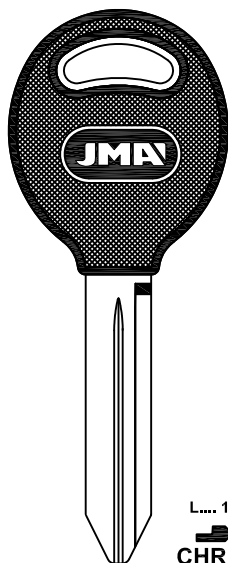

L.... 1-3580



CHR-15.P
CHRYSLER

BRIGGS & STRATTON-YALE

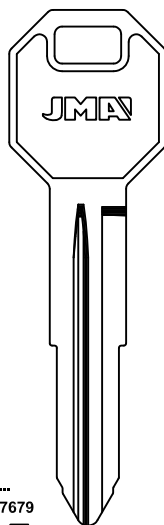

E....
5001-7679



CHR-17
CHRYSLER

CLAUSOR

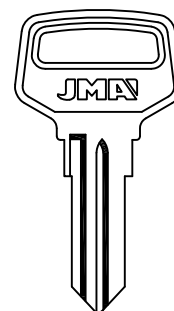

ALU.



CL-11
BRABANTIA

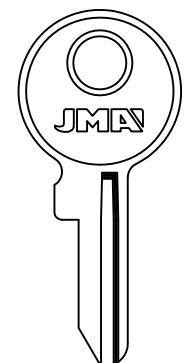

CL-21
EBRO-CAGIVA-LINCE-MAICO
MONTESA-OSSA-PIAGGIO VESPA

CL-2D



CLAUSOR

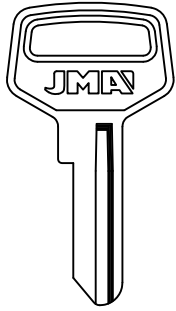

CL-3I

EBRO-CAGIVA-LINCE-MAICO
MONTESSA-OSSA-PIAGGIO VESPA

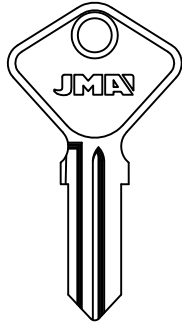

CL-4I

JEEP

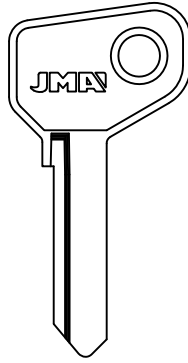

CL-5D

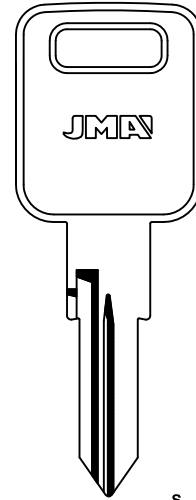

CL-6

SEAT

PARA-FOR:

CLAUSOR (E)

CLICK (RA)

CLUM (USA)

COBRA (I)

CLAUSOR

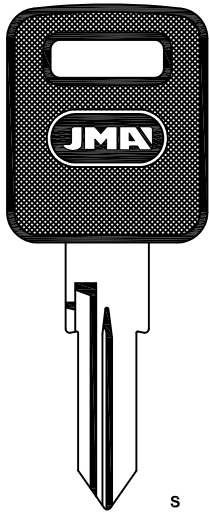

CL-6.P

SEAT

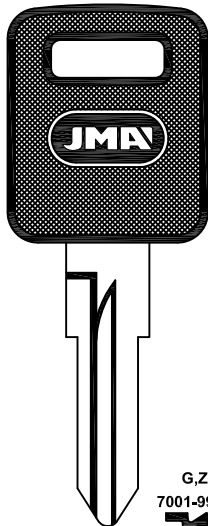

CL-7.P

SEAT
GIOBERT

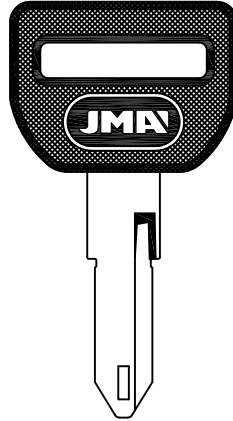

CL-8.P

CITROEN

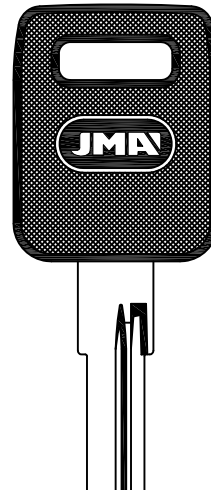

CL-9.P

SEAT

CLAUSOR

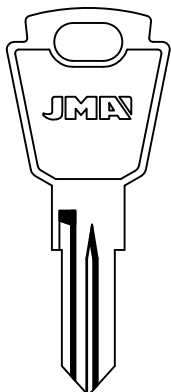

SIM-900

CLICK

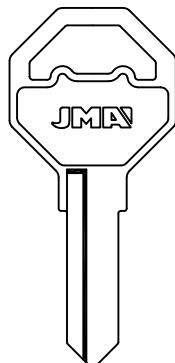

CLI-1D

CLUM

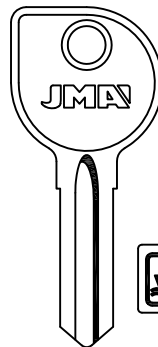

CLU-1I

CLU-1D

CLU-2

CLU-3

CLU-4

CLU-5

MERCURY

COBRA

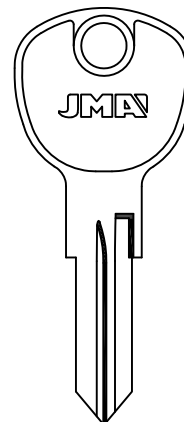

COB-1

JMA

Copyright by Alejandro Altuna S.A. 2014



ATENCIÓN: Concerniente a las marcas y denominaciones comerciales ver nota en índice.
ATTENTION: Concerning the marks and commercial denominations see note in index.
ATTENTION: Concernant les marques et dénominations commerciales voir la note dans l'index.
ACHTUNG: Beziehen auf die marke und handelsname sehen sie die notiz im index.











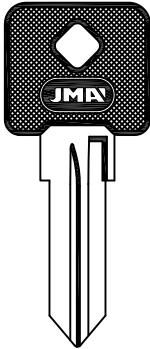
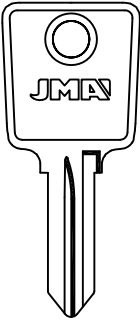
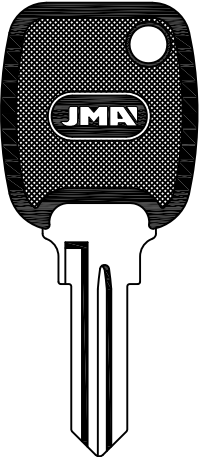
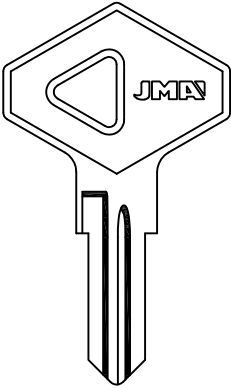









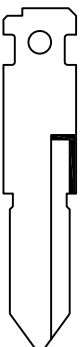
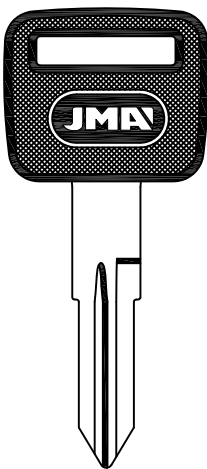

PARA-FOR:

COBRA (I)

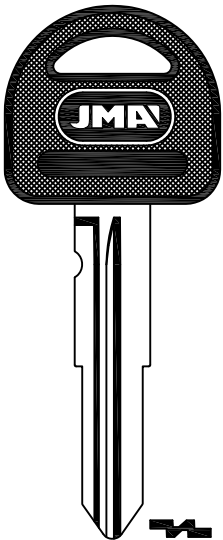
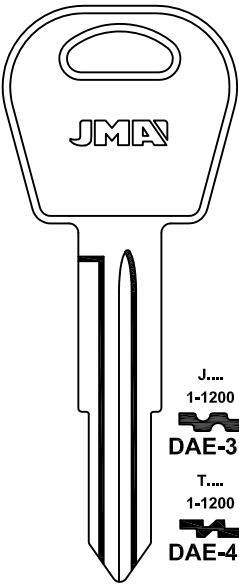
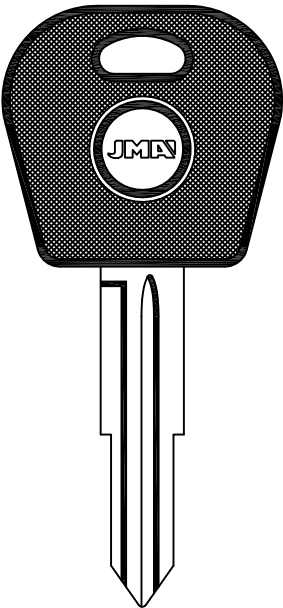
DACIA (R)

DAELIM (K)

DAEWOO (K)

COBRA		DACIA	
			
 	 		
 COB-1.P	 COB-2	 DAC-1D.P	 DAC-2D
DACIA			DAELIM
			
 DAC-3DC1	 DAC-4DC1	 DAC-5C1	 DAL-1.P
	HUF		 DAE-1.P DAEWOO
DAEWOO			
			
 DAE-2D.P DAEWOO	 DAE-3D J... 1-1200	 DAE-4D T... 1-1200	 DAE-3D.P1 J... 1-1200
		 DAE-4.P1 V... 1-1200	 DAE-4D.P1 T... 1-1200



DAEWOO

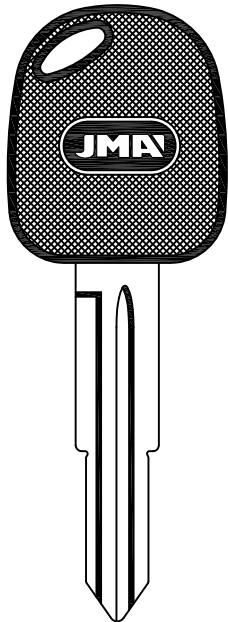

DAE-3.P2 J...
1-1200
DAE-3D.P2

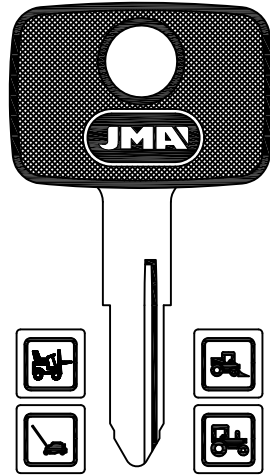

DAE-5.P

DAIHATSU

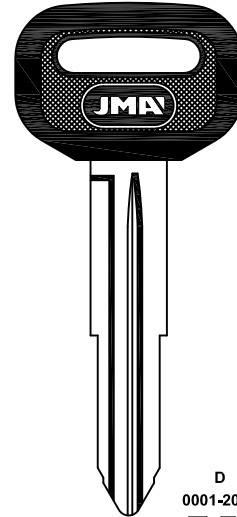

D
0001-2000
DAI-1.P
BERTONE-DAIHATSU

PARA-FOR:

- DAEWOO (K)
- DAIHATSU (J)
- DARMIX (F)
- DAV (F)
- DOBLE G (ARG)
- DOBLINA (D)
- DOM (D)

DAIHATSU

DARMIX

DAV

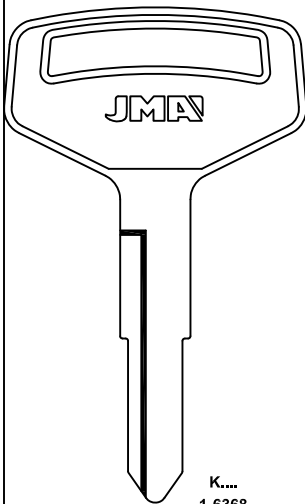

K...
1-6368
DAI-2D

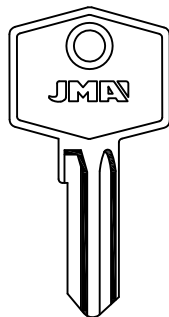

DAR-1

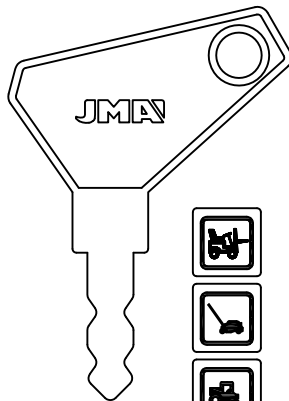

6,1 1,95
DAV-1
DAF-MACK-RENAULT SAVIEM

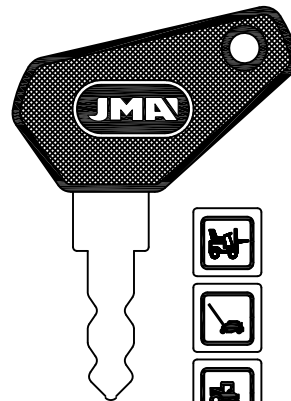

6,1 1,95
DAV-1.P
DAF-MACK-RENAULT SAVIEM

DOBLE G

DOBLINA

DOM

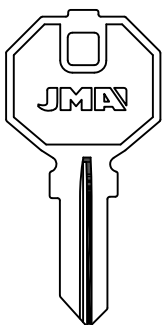

GG-1D

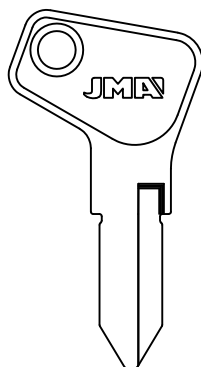

DOB-1 DOB-1D
.....6
10000-44031
DOB-2 DOB-2D
TRABANT-WARTBURG

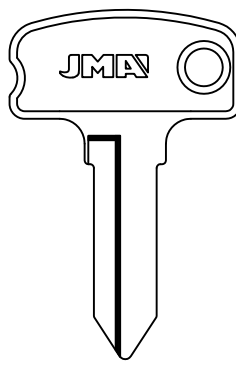

10000-44031
....26 25
DOB-3 DOB-3D
TRABANT-WARTBURG

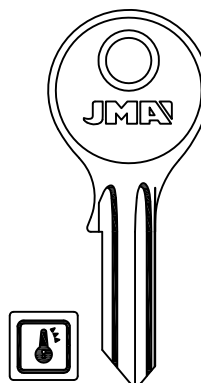









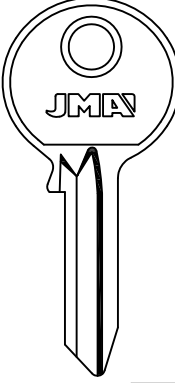
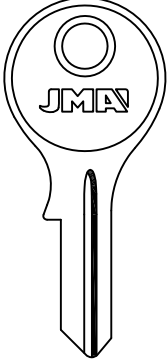
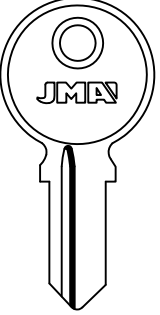
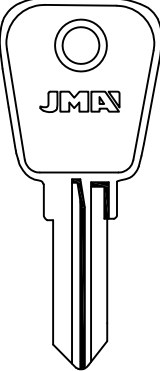





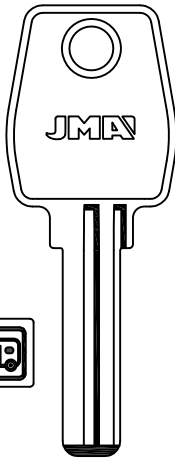
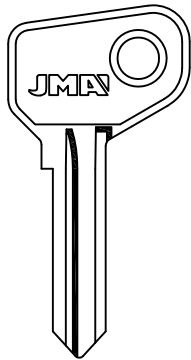
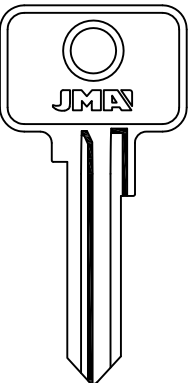
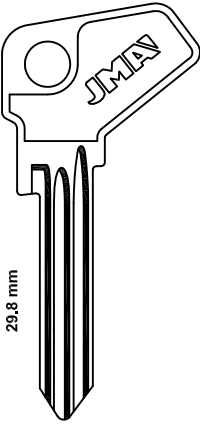

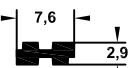



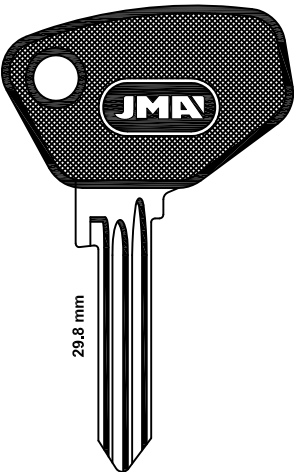
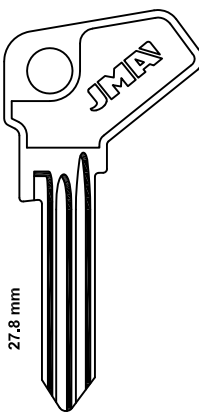
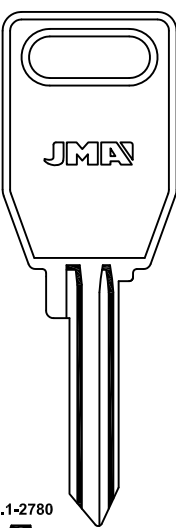

EV...1-2840
GS...1-1000
FT...1-1000
CQ...301-400
....1-1000
EV...1-2840
DOM-9 DOM-9D
NOBO

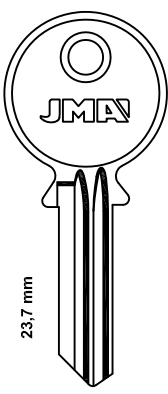

PARA-FOR:

- DOM (D)
- DUBOIS (F)
- ECHO (I)
- EUROLOCKS (B)
- FAAB (I)
- FAB (CZ)

DOM		DUBOIS		ECHO	
					
 FA-GZ 0001-3948  DOM-14D	 DOM-38D	A... 1-2-3  DU-1 FLAMBO-YVEL		 ECH-1	
EUROLOCKS		FAAB		FAB	
					
 LAT.  7,6 2,9 EU-12 HOBBY-HYMER	 2 100-309  FAB-1	 4... 100-309  FAB-2		29,8 mm  SKO-1 SKODA	
FAB					
					
29,8 mm  SKO-1.P SKODA	27,8 mm  SKO-2 SKODA	4AB...1-2780  SKO-3I SKODA	4AB...1-2780  SKO-3I.P SKODA	23,7 mm  SKO-4 SKODA	



FAB

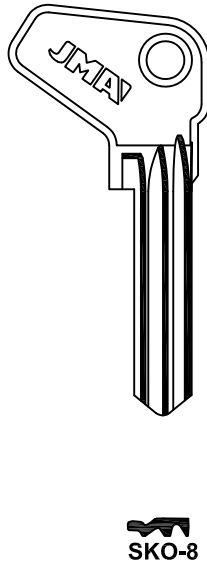
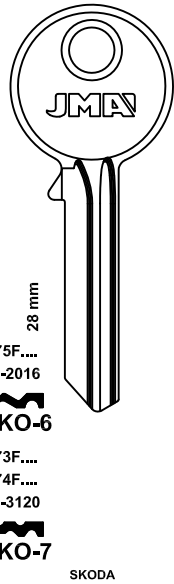

FAICA

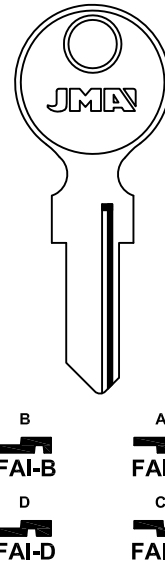

PARA-FOR:

- FAB (CZ)
- FAICA (E)
- FARMA (I)
- FEMSA (E)
- FIAT (I)
- FIST (I)
- FLORA (D)
- FORD (USA)

FARMA

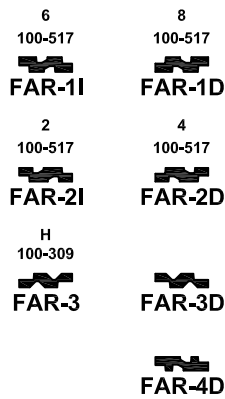
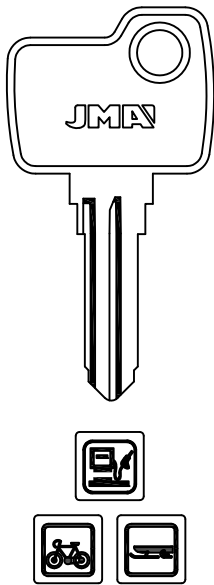

FEMSA

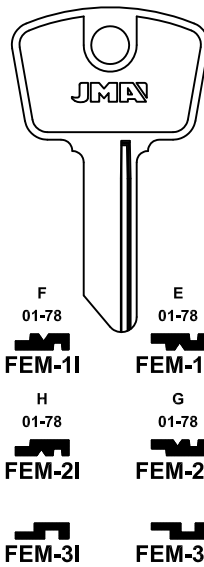

FIAT

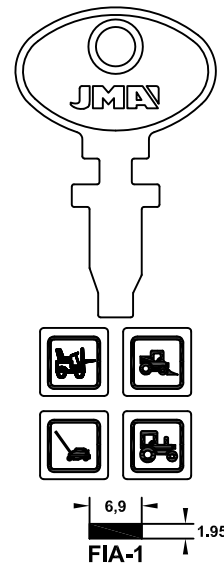

FIAT

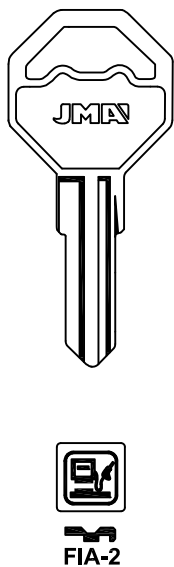

FIST

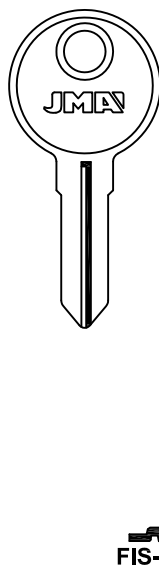

FLORA

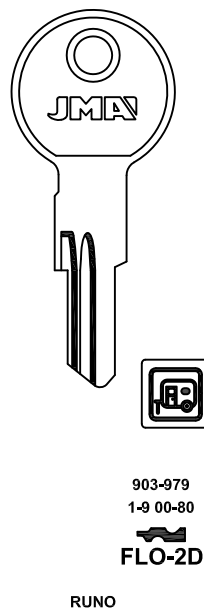

FORD

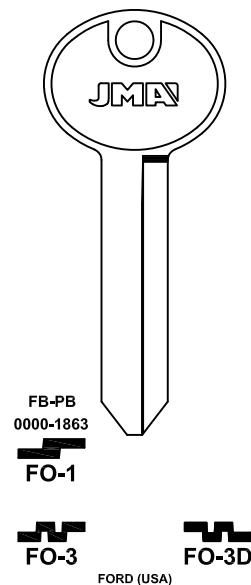

PARA-FOR:
FORD (USA)

FORD

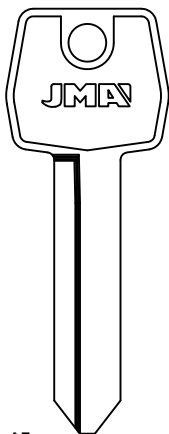

AF
0001-2600
FA-PA
0000-1863

FO-2
FORD (USA)-MASERATI



FO-3.P **FO-3D.P**
FORD (USA)

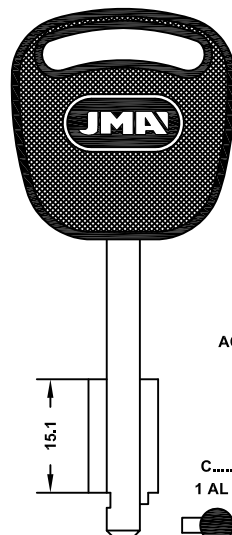

ACE.
15.1
C.....
1 AL 5
FO-4.P

FORD
KOLB

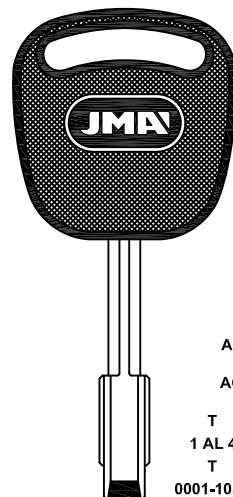

ALP.
ACE.
T
1 AL 4
T
0001-1050

FO-6.P

FORD
HUF

FORD

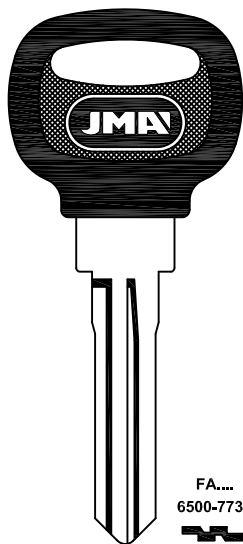

FA....
6500-7733
FO-7.P

FORD

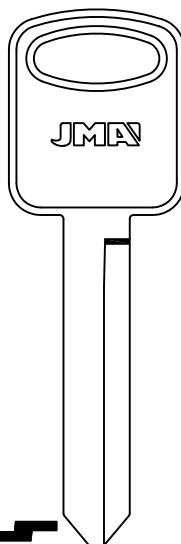

FO-8

FORD

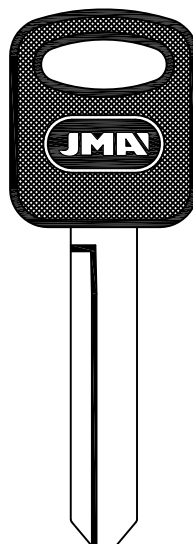

A
101-291
501-579
B
101-332
501-602
C
101-344
501-624
D
101-327
501-602
E
101-296
501-579

FO-8D

FORD

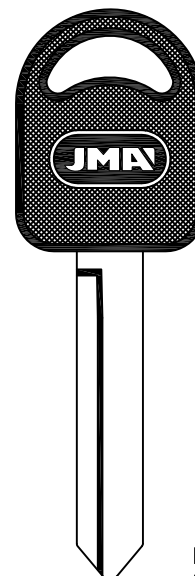

A
101-291
501-579
B
101-332
501-602
C
101-344
501-624
D
101-327
501-602
E
101-296
501-579

FO-8D.P

FO-8D.P1

FORD-MERCURY

FORD

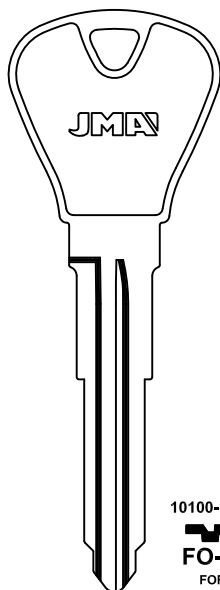

10100-12099
FO-9D

FORD

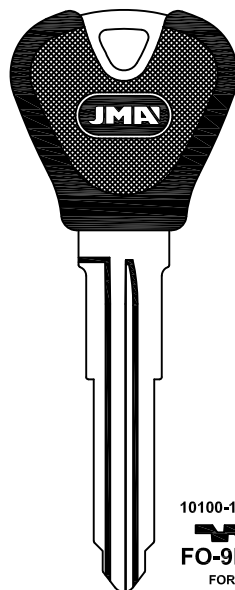

10100-12099
FO-9D.P

FORD

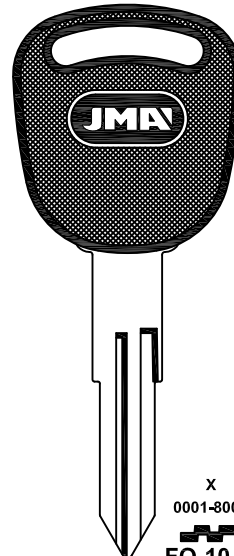

X
0001-8000
FO-10.P

FORD

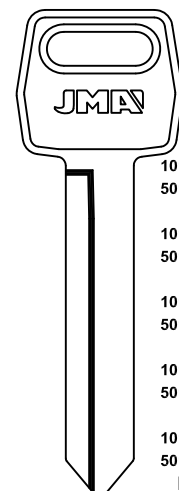

A
101-291
501-579
B
101-332
501-602
C
101-344
501-624
D
101-327
501-602
E
101-296
501-579
FA
6500-7733

FO-11D

FORD



FORD

PARA-FOR:

FORD (USA)

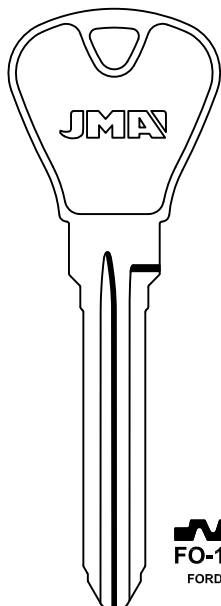

FO-12
FORD

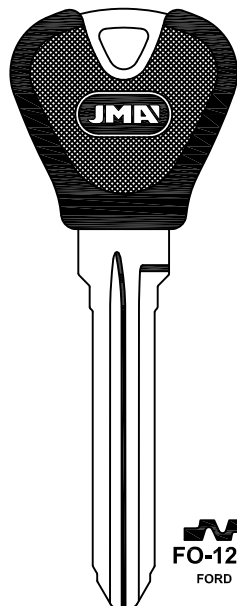

FO-12.P
FORD

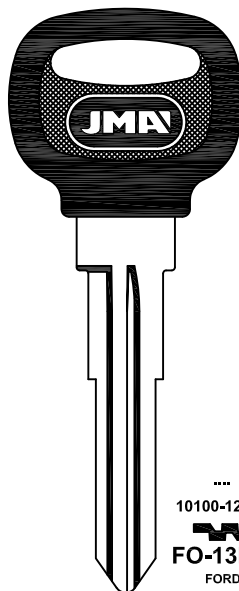

....
10100-12099
FO-13D.P
FORD

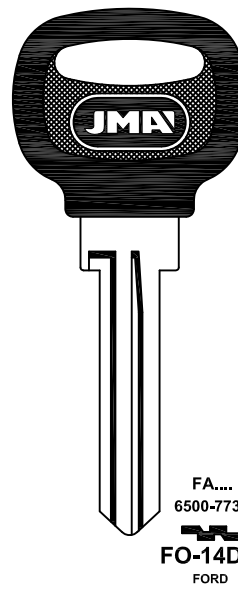

FA....
6500-7733
FO-14D.P
FORD

FORD

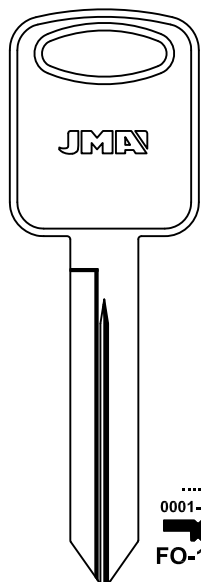

....X
0001-1706
FO-15D

STRATTEC

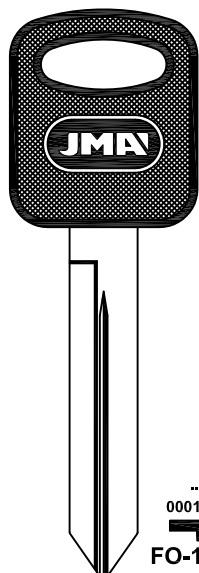

....X
0001-1706
FO-15D.P

STRATTEC

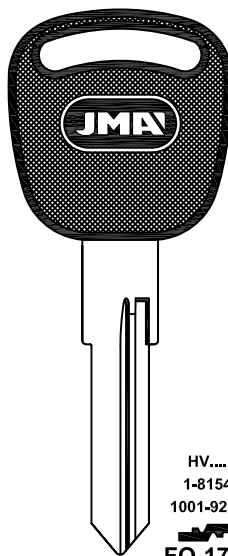

HV....
1-8154
1001-9282
FO-17.P

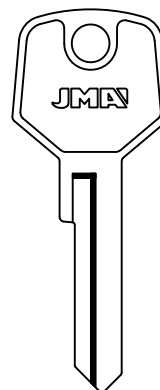

FO-18D

FORD

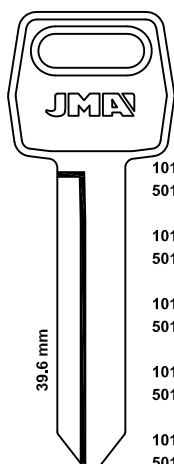

39.6 mm

- A
101-291
501-579
- B
101-332
501-602
- C
101-344
501-624
- D
101-327
501-602
- E
101-296
501-579
- FA
6500-7733

FO-20D
FORD

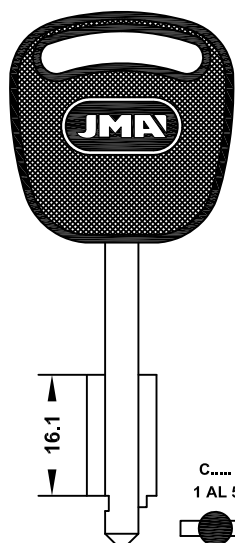

16.1

C....
1 AL 5
FO-22.P

FORD
KOLB

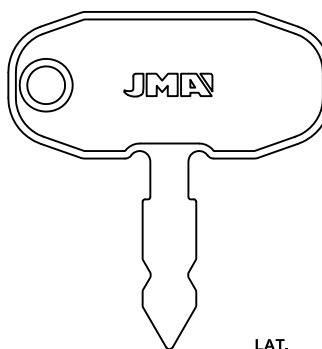

LAT.



FO-35



PARA-FOR:
FORD (USA)

FORD

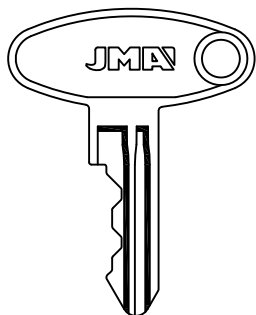

FO-36

LAT.

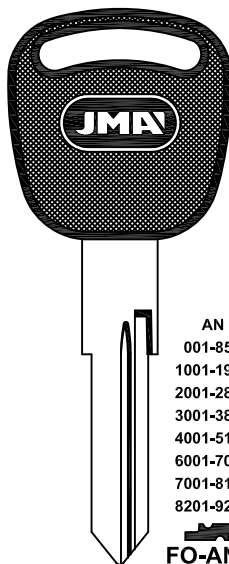

AN
001-854
1001-1918
2001-2830
3001-3890
4001-5151
6001-7086
7001-8154
8201-9282

FO-AN.P

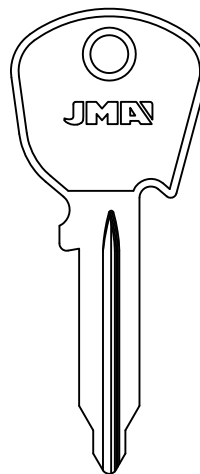

B-D-DV
01-64

FO-D

FORD-JAGUAR-VOLKSWAGEN
BRITAX-KOLB

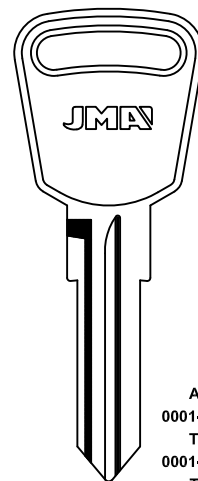

AK
0001-1000
TC
0001-1000
TX
0001-1859

FO-E/TC

ASTON M.-FORD-JAGUAR-ROVER-YUGO
CASI-CEM-CLAUSOR-KOLB-NEIMAN

FORD

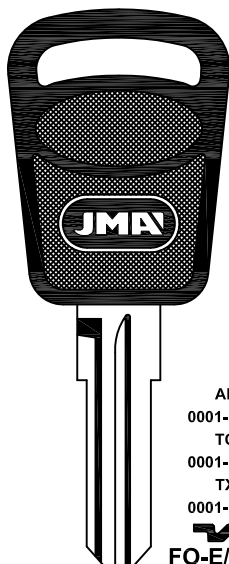

AK
0001-1000
TC
0001-1000
TX
0001-1859

FO-E/TC.P

ASTON M.-FORD-JAGUAR-ROVER-YUGO
CASI-CEM-CLAUSOR-KOLB-NEIMAN

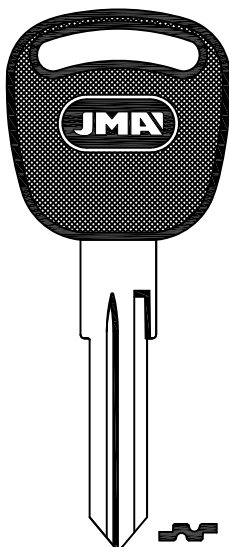

FO-FH.P

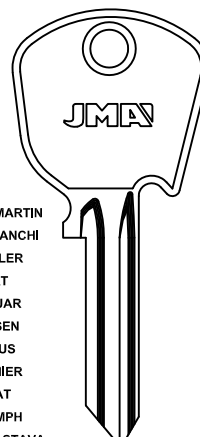

ASTON MARTIN
AUTOBIANCHI
DAIMLER
FIAT
JAGUAR
JENSEN
LOTUS
PREMIER
SEAT
TRIUMPH
YUGO ZASTAVA

FR
1-3040
4001-6000

FO-FK FO-FR

ARMAN-DOM-JUGODENT-WASO

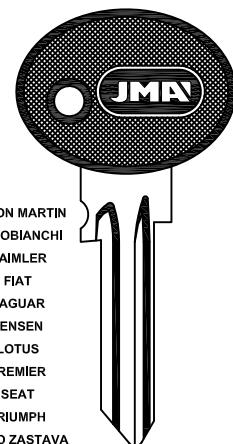

ASTON MARTIN
AUTOBIANCHI
DAIMLER
FIAT
JAGUAR
JENSEN
LOTUS
PREMIER
SEAT
TRIUMPH
YUGO ZASTAVA

FR
1-3040
4001-6000

FO-FK.P FO-FR.P

ARMAN-DOM-JUGODENT-WASO

FORD

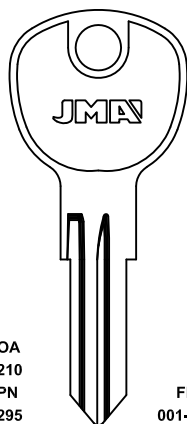

DA-OA
001-210
ER-PN
101-295
ER
001-195
ER
501-695

FO-OA

DAF-EBRO-KENWORTH-VOLKSWAGEN
CASI-HUF-YMOS

OL
001-210
07R
001-195
7OR
001-210

FO-OL

CASI-YMOS

OB...
1-210

VO-7

NSU

O7L
001-195
7OL
001-210
OR
001-210

FO-OR

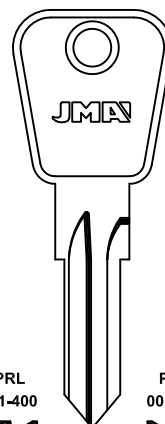

PRL
001-400

FO-PRL

XL
001-195

FO-XL

FORD
CASI-YMOS

PRR
001-400

FO-PRR

XR
001-195

FO-XR

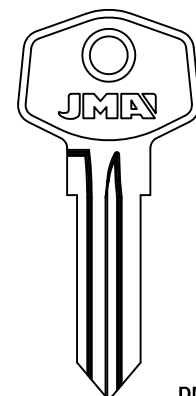

DM
300-400
TC-AK
0001-1000
TX
0001-1859

FO-TC

DAF-DAIMLER-FORD-JAGUAR
CASI-CEM-KOLB



FORD

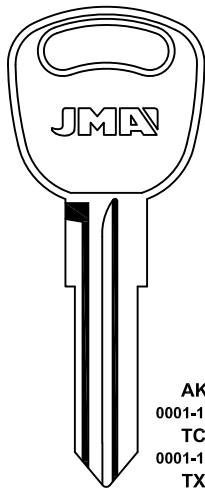

AK
0001-1000
TC
0001-1000
TX
0001-1859



FORD

CASI-CEM-CLAUSOR-KOLB-NEIMAN

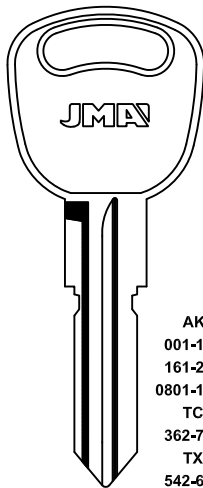

AK
001-100
161-250
0801-1000
TC
362-728
TX
542-671
1300-1601



FORD

FO-TX1

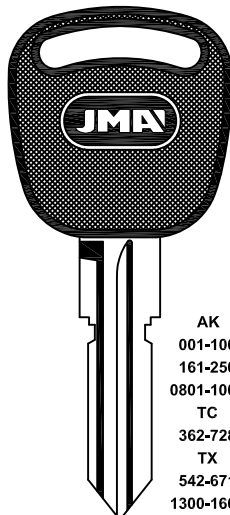

AK
001-100
161-250
0801-1000
TC
362-728
TX
542-671
1300-1601



FORD

CASI-CEM-CLAUSOR-KOLB-NEIMAN

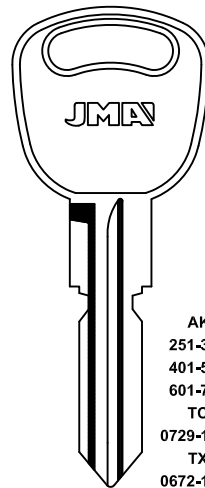

AK
251-300
401-500
601-700
TC
0729-1000
TX
0672-1000
1602-1859



FORD

FO-TX2

PARA-FOR:

FORD (USA)

GAS (RA)

G.M. (USA)

FORD



AK
251-300
401-500
601-700
TC
0729-1000
TX
0672-1000
1602-1859



FORD

CASI-CEM-CLAUSOR-KOLB-NEIMAN



AK
0001-1000
TC
0001-1000
TX
0001-1859



FORD

FO-TX.P

GAS

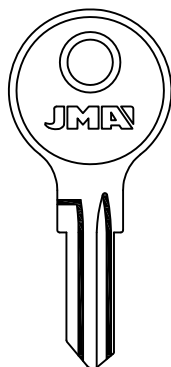

GAS-1



GAS-1D

G.M.

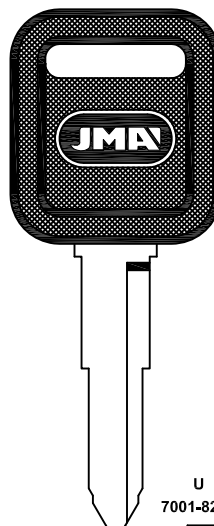

U
7001-8200



GM-1.P

G.M.

BRIGGS STRATTON

GENERAL MOTORS

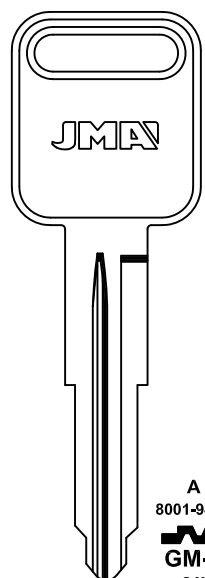

A
8001-9400



GM-2

G.M.

BRIGGS STRATTON

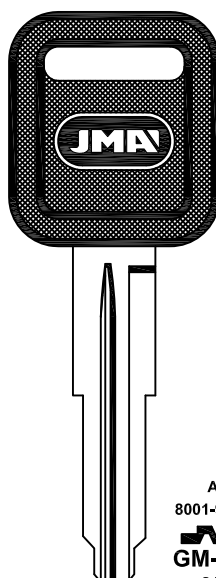

A
8001-9400



GM-2.P

G.M.

BRIGGS STRATTON

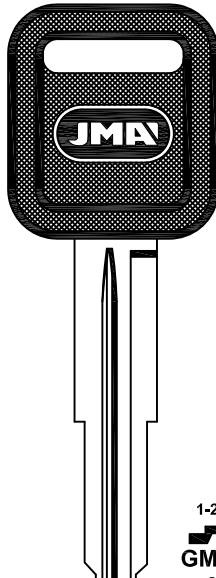

U
1-2000



GM-3.P

G.M.

BRIGGS S.

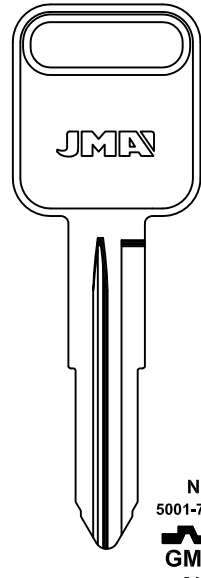

N
5001-7000



GM-4

G.M.

BRIGGS STRATTON



PARA-FOR:

G.M. (USA)

GENERAL MOTORS



N
5001-7000

GM-4.P
G.M.

BRIGGS STRATTON



N
5001-7000

GM-4.P1
G.M.

BRIGGS STRATTON

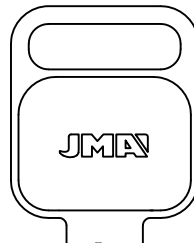

U
1-2000

GM-5
G.M.

BRIGGS S.



U
1-2000

GM-5.P
G.M.

BRIGGS S.

GENERAL MOTORS

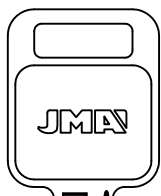

A
000-999

GM-6

E
000-999

GM-8

G.M.

BRIGGS STRATTON

C
000-999

GM-7

J
000-999

GM-9



A
000-999

GM-6.P

E
000-999

GM-8.P

G.M.

BRIGGS STRATTON

C
000-999

GM-7.P

J
000-999

GM-9.P

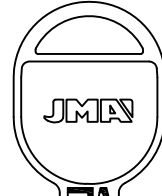

B
000-999

GM-10

H
000-999

GM-12

G.M.

BRIGGS STRATTON

D
000-999

GM-11

K
000-999

GM-13



B
000-999

GM-10.P

H
000-999

GM-12.P

G.M.

BRIGGS STRATTON

D
000-999

GM-11.P

K
000-999

GM-13.P

GENERAL MOTORS

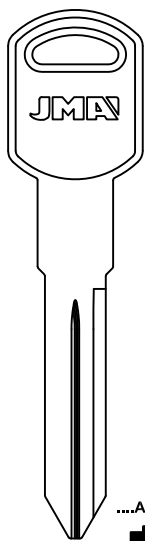

....A00-7N45

GM-14

G.M.

BRIGGS STRATTON

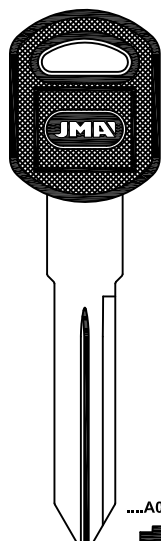

....A00-7N45

GM-14.P

G.M.

BRIGGS STRATTON

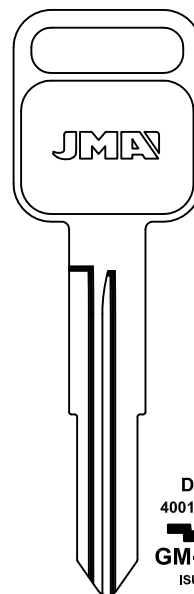

D....
4001-6000

GM-15D

BRIGGS S.

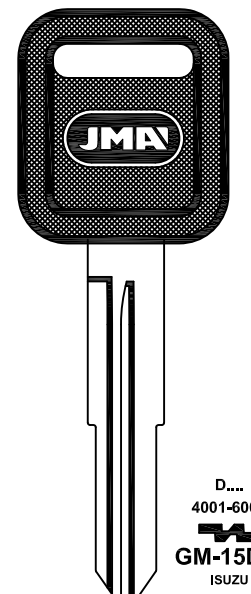

D....
4001-6000

GM-15D.P

ISUZU
BRIGGS S.



GENERAL MOTORS

PARA-FOR:

G.M. (USA)

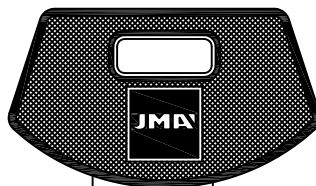

LAT.

A
..A..0.00-9.99
..B..0.00-9.99
..V..0.00-9.99
..V..0.00-9.99
..W..0.00-9.99
..W..0.00-9.99



GM-16.P

E
..J..0.00-9.99
..K..0.00-9.99



GM-18.P

G.M.

BRIGGS STRATTON

C
..A..0.00-9.99
..B..0.00-9.99
..N..0.00-9.99
..N..0.00-9.99
..P..0.00-9.99
..P..0.00-9.99



GM-17.P

G.M.

BRIGGS STRATTON

C
..A..0.00-9.99
..B..0.00-9.99
..N..0.00-9.99
..N..0.00-9.99
..P..0.00-9.99
..P..0.00-9.99



GM-19.P

LAT.

E
..J..0.00-9.99
..K..0.00-9.99



GM-20.P

GENERAL MOTORS

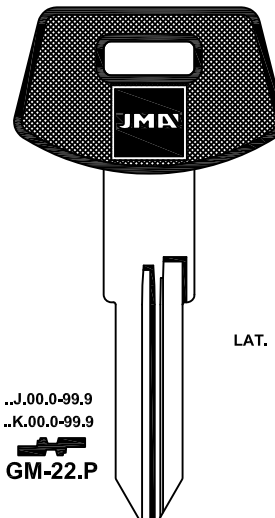
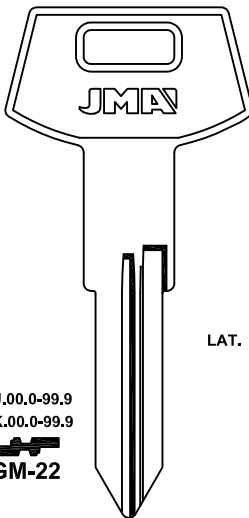
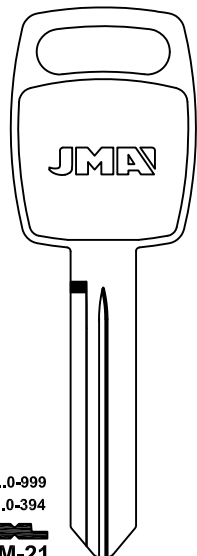

LAT.

LAT.

LAT.

LAT.

R...0-999
T...0-394



GM-21

BRIGGS & STRATTON

R...0-999
T...0-394



GM-21.P

BRIGGS & STRATTON

..J..0.00-9.99
..K..0.00-9.99



GM-22



GM-23

G.M.
BRIGGS STRATTON

..J..0.00-9.99
..K..0.00-9.99



GM-22.P



GM-23.P

G.M.
BRIGGS STRATTON

GENERAL MOTORS

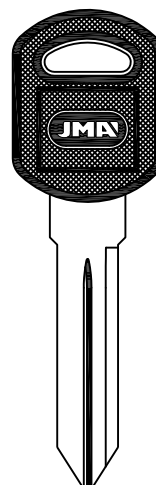
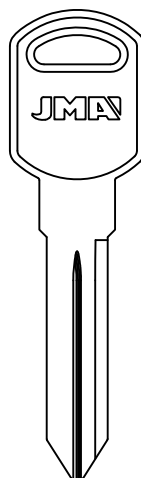
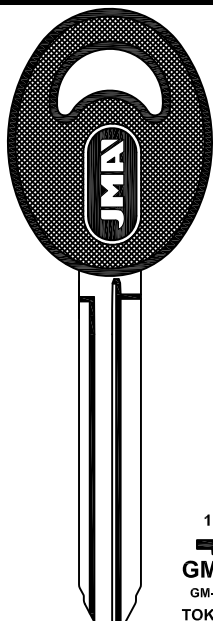
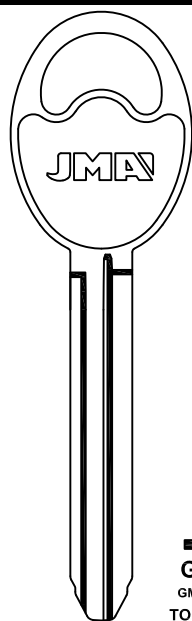

LAT.

LAT.

1....
1-5000



GM-24

GM-TOYOTA
TOKAJ-RIKA

1....
1-5000



GM-24.P

GM-TOYOTA
TOKAJ-RIKA

....A00-7N45



GM-25

G.M.
BRIGGS STRATTON

....A00-7N45



GM-25.P

G.M.
BRIGGS STRATTON



PARA-FOR:

G.M. (USA)

GEWU (D)

GHE (D)

GENERAL MOTORS

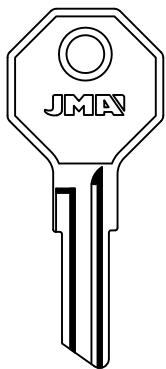

GM-26

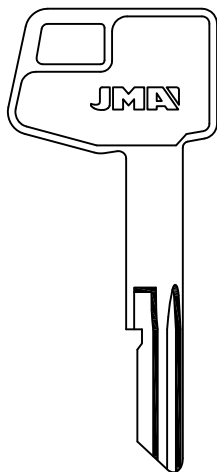

0000-1999
GM-42

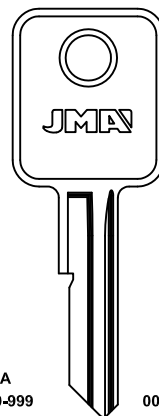

A
000-999
GM-A

E
000-999
GM-E



C
000-999
GM-C

J
000-999
GM-J

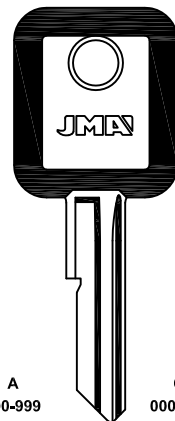

A
000-999
GM-A.P

E
000-999
GM-E.P



C
000-999
GM-C.P

J
000-999
GM-J.P

G.M.
BRIGGS STRATTON

G.M.
BRIGGS STRATTON

GENERAL MOTORS

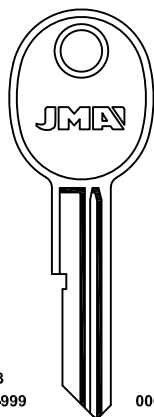

B
000-999
GM-B

H
000-999
GM-H

G.M.
BRIGGS STRATTON

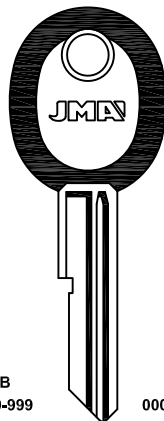

D
000-999
GM-D

K
000-999
GM-K

G.M.
BRIGGS STRATTON

GEWU

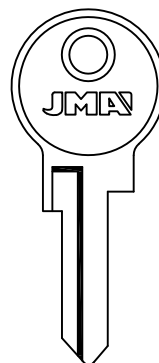

GW-1D

ZUNDAPP

GHE

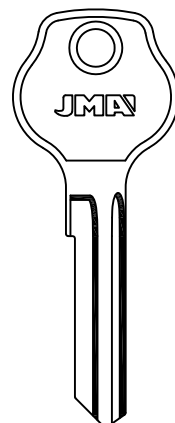

GH-1

GHE

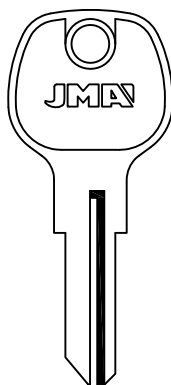

GY
25-90
GH-2

PEROHAUS-POS-WECO

LAT.

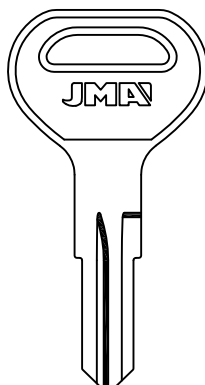

LS 378-616
GH-3

KASSBOHRER

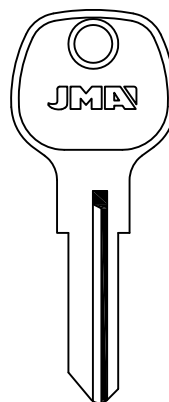

GX
091-320
GH-GX

PEROHAUS-POS-WECO



HX
091-320
GH-HX

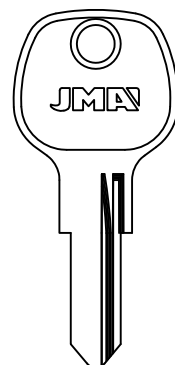

PS
139
GH-PS



GIOBERT

PARA-FOR:

GIOBERT (I)

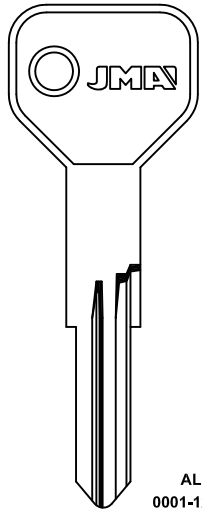

AL
0001-1274



ALFA ROMEO
YMOS

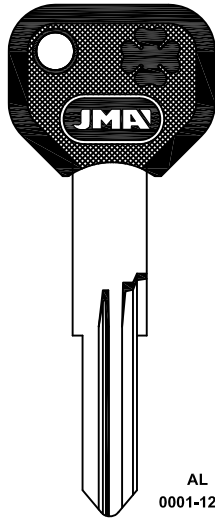

AL
0001-1274



AF-13.P

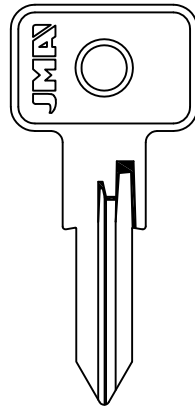

K-H
7001-8092



AF-14

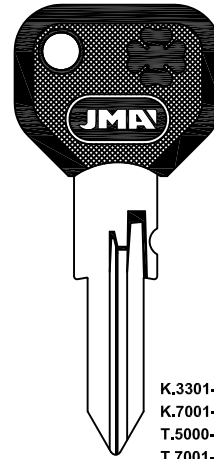

K-H
7001-8092



AF-14.P

ARMAN-CLAUSOR

FIST-M.MARELLI-NEIMAN-SIPEA

K.3301-4886
K.7001-8092
T.5000-6027
T.7001-8092
S.0501-3278
H.7001-8092



FI-6I.P4

GIOBERT

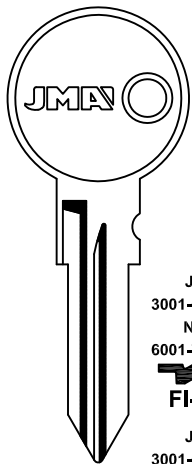

J
3001-6732
N
6001-7000



FI-1

J
3001-6732
N
6001-7000



FI-10

AUTOBIANCHI-FIAT-LANCIA
RAYTON FISSORE-STREYR PUCH
CAGIVA-GILERA-PIAGGIO VESPA

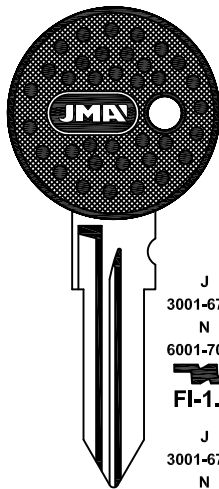

J
3001-6732
N
6001-7000



FI-1.P

J
3001-6732
N
6001-7000



FI-10.P

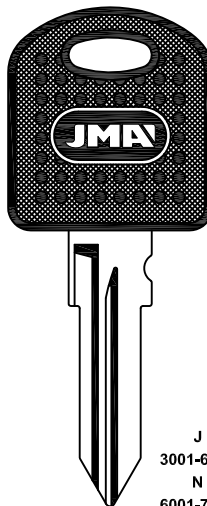

J
3001-6732
N
6001-7000



FI-1.P8

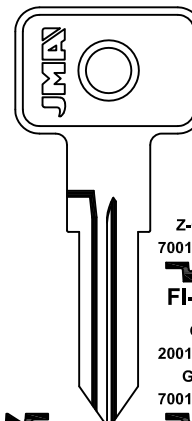

Z-GR
7001-9956



FI-2D

G
2001-4530

G-Z
7001-9956



FI-3D

G
7001-9956



FI-12

A. ROMEO-AUTOBIANCHI-CITROEN-FIAT
INNOCENTI-LANCIA-PEUGEOT-SEAT
YUGO ZASTAVA-FIAT IVECO

GIOBERT

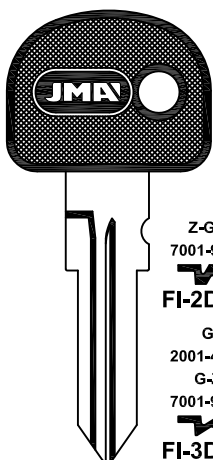

Z-GR
7001-9956

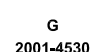

FI-2D.P3

G
2001-4530

G-Z
7001-9956



FI-3D.P3

G
7001-9956



FI-12.P3

A. ROMEO-AUTOBIANCHI-CITROEN-FIAT
LANCIA-PEUGEOT-SEAT

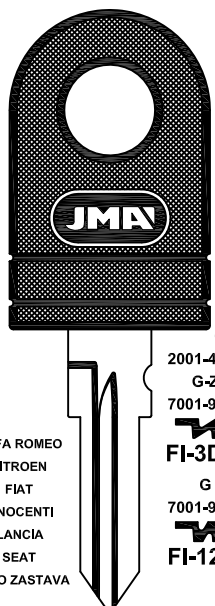

ALFA ROMEO
CITROEN
FIAT
INNOCENTI
LANCIA
SEAT
YUGO ZASTAVA

G
2001-4530
G-Z
7001-9956



FI-3D.P

G
7001-9956



FI-12.P

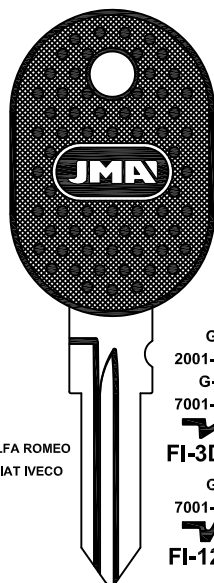

ALFA ROMEO
FIAT IVECO

G
2001-4530
G-Z
7001-9956



FI-3D.P1

G
7001-9956



FI-12.P1

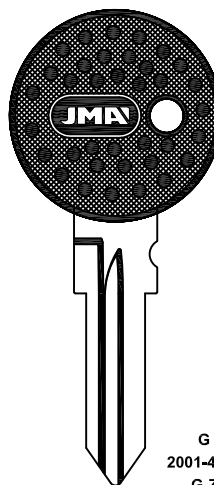

G
2001-4530
G-Z
7001-9956



FI-3D.P2

FIAT

JMA[®]

Copyright by Alejandro Altuna S.A. 2014



ATENCIÓN: Concerniente a las marcas y denominaciones comerciales ver nota en índice.
ATTENTION: Concerning the marks and commercial denominations see note in index.
ATTENTION: Concernant les marques et dénominations commerciales voir la note dans l'index.
ACHTUNG: Beziehen auf die marke und handelsname sehen sie die notiz im index.

PARA-FOR:

GIOBERT (I)

GIOBERT

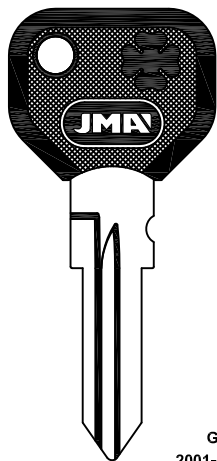

G
2001-4530
G-Z
7001-9956

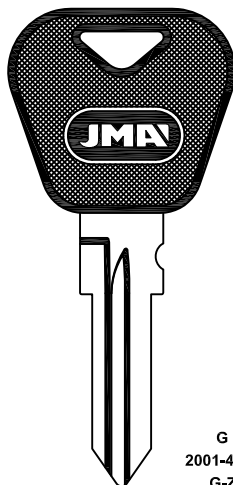

FI-3D.P4
ALFA ROMEO

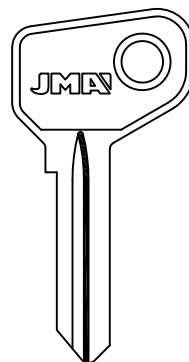

G
2001-4530
G-Z
7001-9956

FI-3D.P5
INNOCENTI-YUGO ZASTAVA



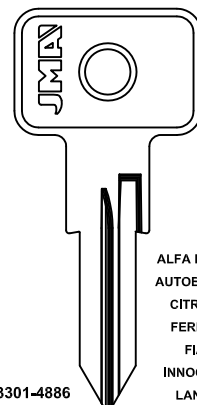

FI-4D
 FI-5I
 FI-5D
OM IVECO-FIAT IVECO
IACAM



K 3301-4886
K 7001-8092
T 5000-6027
T 7001-8092
S 0501-3278
H 7001-8092

FI-6I
ALFA ROMEO
AUTOBIANCHI
CITROEN
FERRARI
FIAT
INNOCENTI
LANCIA
PEUGEOT
YUGO ZASTAVA
CAGIVA
DUCATI
FANTIC MOTOR
GARELLI
GILERA

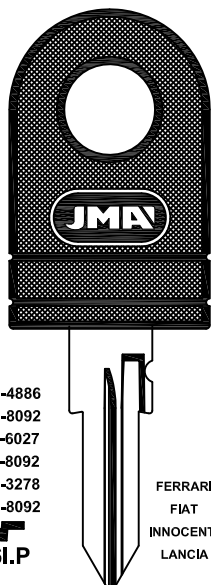
GIOBERT



K 3301-4886
K 7001-8092
T 5000-6027
T 7001-8092
S 0501-3278
H 7001-8092

FI-6I.P
FERRARI
FIAT
INNOCENTI
LANCIA

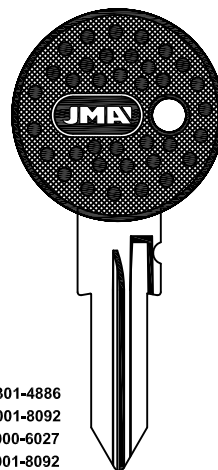

K 3301-4886
K 7001-8092
T 5000-6027
T 7001-8092
S 0501-3278
H 7001-8092

FI-6I.P1
A. ROMEO
FIAT IVECO

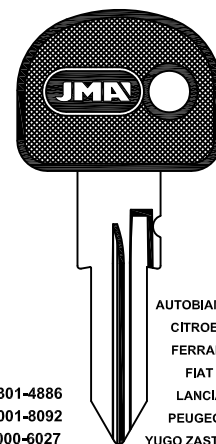

K 3301-4886
K 7001-8092
T 5000-6027
T 7001-8092
S 0501-3278
H 7001-8092

FI-6I.P2
FERRARI
FIAT
CAGIVA



K 3301-4886
K 7001-8092
T 5000-6027
T 7001-8092
S 0501-3278
H 7001-8092

FI-6I.P3
AUTOBIANCHI
CITROEN
FERRARI
FIAT
LANCIA
PEUGEOT
YUGO ZASTAVA
CAGIVA
DUCATI
FANTIC MOTOR
GARELLI
GILERA

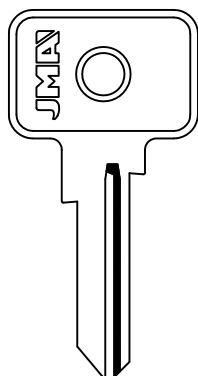
GIOBERT

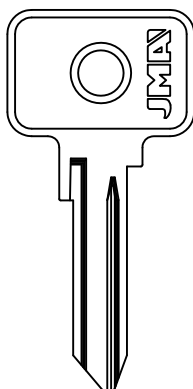

X
3301-4886

FI-7I
FIAT
NEIMAN-SIPEA

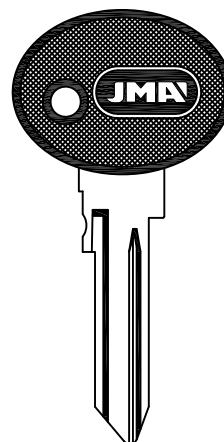

Y
7001-9956

FI-8I
AUTOBIANCHI-FIAT-SEAT
ARMAN

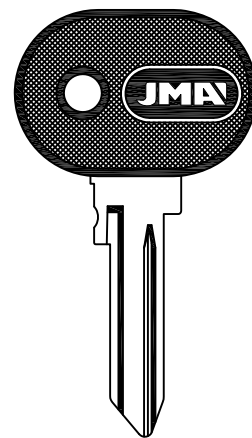

Y
7001-9956

FI-8I.P
AUTOBIANCHI-FIAT-SEAT
ARMAN



Y
7001-9956

FI-8I.P1
FIAT-FIAT IVECO
ARMAN



GIOBERT

PARA-FOR:

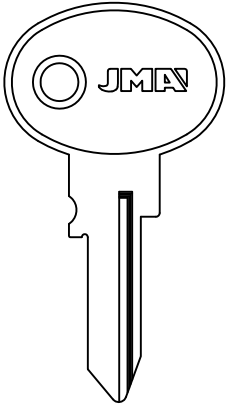
GIOBERT (I)



M
0001-1050

FI-9I

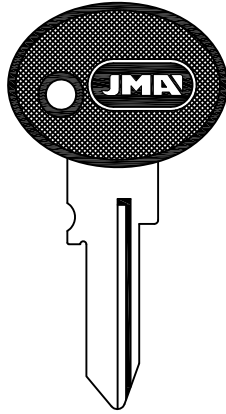

M
0001-1050

FI-9I.P

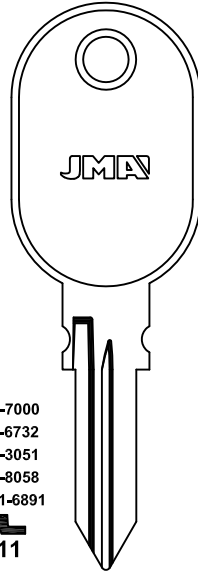

N 6001-7000
J 3001-6732
V 0001-3051
V 5001-8058
AB 6001-6891

FI-11

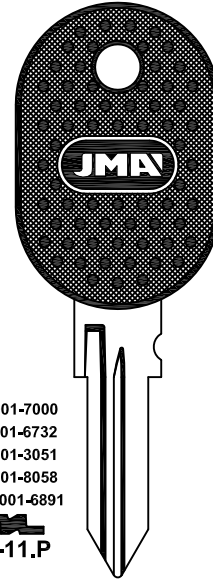

N 6001-7000
J 3001-6732
V 0001-3051
V 5001-8058
AB 6001-6891

FI-11.P

ALFA ROMEO-AUTOBIANCHI-FIAT-LANCIA
OM IVECO-SEAT-STEYR PUCH

AUTOBIANCHI-FIAT-INNOCENTI-LANCIA
RAYTON FISSORE-STEYR PUCH-APRILIA

GIOBERT

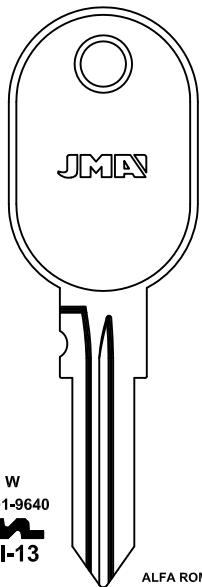

W
0001-9640

FI-13

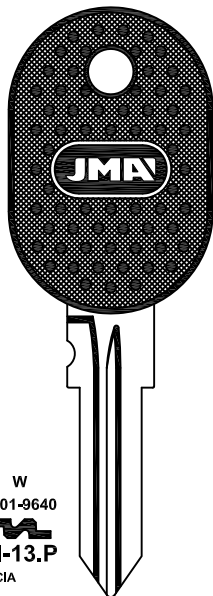

W
0001-9640

FI-13.P

ALFA ROMEO-FIAT-LANCIA

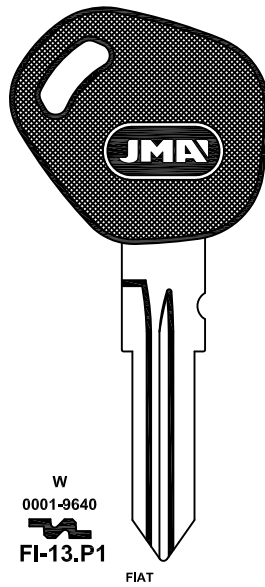

W
0001-9640

FI-13.P1

FIAT

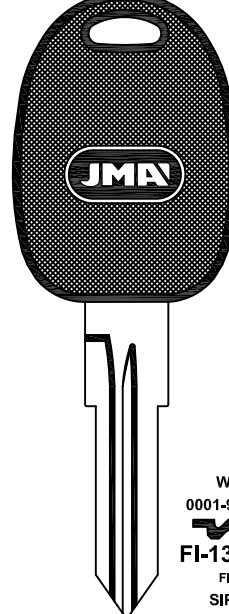

W
0001-9640

FI-13.P7
FIAT
SIPEA

GIOBERT

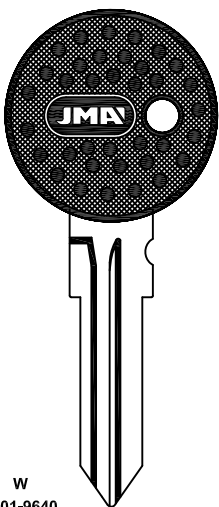

W
0001-9640

FI-14.P

ALFA ROMEO-FIAT-LANCIA

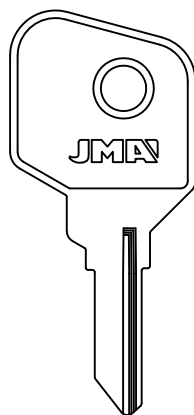

FI-15

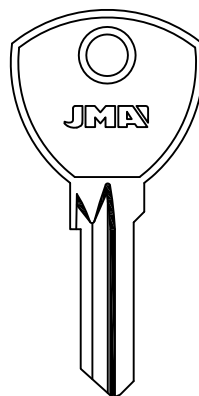

GIOB-2I

LANCIA-MASERATI



GIOB-1D

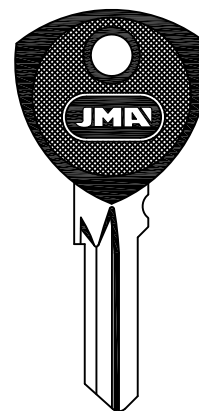

GIOB-2I.P

LANCIA-MASERATI









GIOB-1D.P

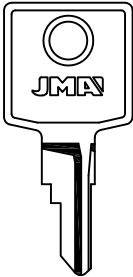

PARA-FOR:

- GIOBERT (I)
- HAMA (D)
- HARLEY DAV. (USA)
- HONDA (J)

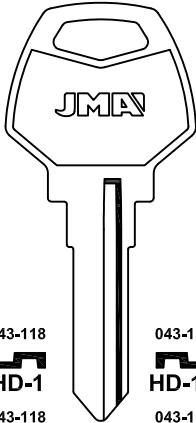
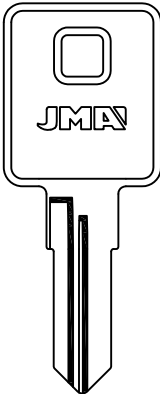
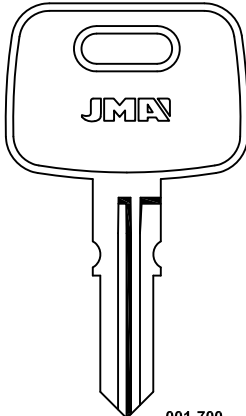
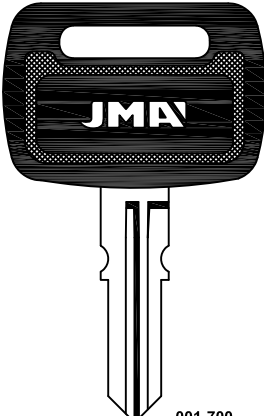
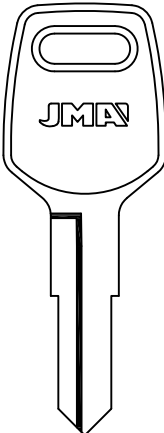
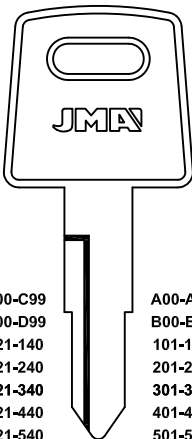
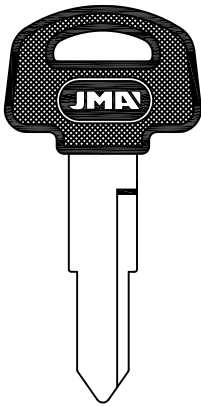
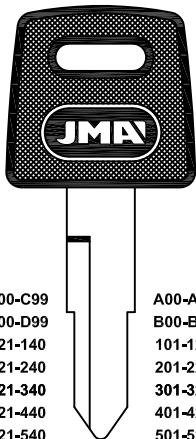
GIOBERT		HAMA		HARLEY DAV.	
 <p>ALP. ALFA ROMEO LA FORZA LANCIA RAYTON FISSORE 0001-1530</p>  <p>GIOB-3.P SAFE</p>	 <p>ALP. ALFA ROMEO LA FORZA LANCIA RAYTON FISSORE 0001-1530</p>  <p>GIOB-3.P2 SAFE</p>	  <p>751-762 HA-1I</p> <p>FORD BLAU</p> <p>778-789 HA-1D</p>	 <p>043-118 HD-1</p> <p>043-118 HD-2</p> <p>043-118 HD-3</p> <p>HARLEY DAVIDSON</p> <p>043-118 HD-1D</p> <p>043-118 HD-2D</p> <p>043-118 HD-3D</p>		
HARLEY DAV.		HONDA			
 <p>HD-4D</p>	 <p>001-700 HOND-1</p> <p>001-700 HOND-2</p> <p>HONDA-TRIUMPH</p>	 <p>001-700 HOND-1.P</p> <p>001-700 HOND-2.P</p> <p>HONDA-TRIUMPH</p>	 <p>1 AL 4</p> <p>HOND-3I HOND-3D</p> <p>HONDA</p>		
HONDA					
 <p>C00-C99 D00-D99 121-140 221-240 321-340 421-440 521-540 621-640 721-740 821-840</p> <p>A00-A99 B00-B99 101-120 201-220 301-320 401-420 501-520 601-620 701-720 801-820</p> <p>HOND-4I HOND-4D</p> <p>HONDA</p>	 <p>HOND-25.P2</p> <p>HOND-30.P2</p> <p>HONDA</p>	<p>A00-A99 B00-B99 101-120 201-220 301-320 401-420 501-520 601-620 701-720 801-820</p> <p>HOND-4D.P2</p> <p>HOND-30D.P2</p>	 <p>C00-C99 D00-D99 121-140 221-240 321-340 421-440 521-540 621-640 721-740 821-840</p> <p>A00-A99 B00-B99 101-120 201-220 301-320 401-420 501-520 601-620 701-720 801-820</p> <p>HOND-4I.P HOND-4D.P</p> <p>HONDA</p>		



HONDA

PARA-FOR:
HONDA (J)

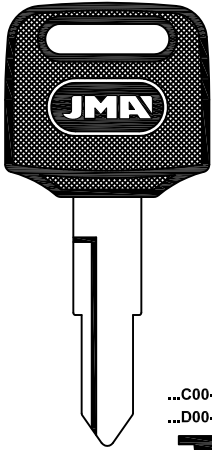

...C00-C99
...D00-D99
HOND-4I.P1

...A00-A99
...B00-B99
HOND-4D.P1

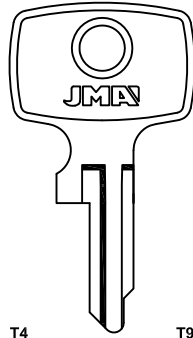

T4
HOND-5I

T9
HOND-5D

T1
HOND-6I

2 AL 9
3 AL 6
T6
HOND-6D

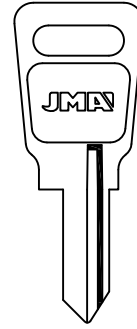

HOND-18.P
HONDA

HOND-18D.P

T3
HOND-7I
HONDA

T8
HOND-7D
HONDA

HOND-8I
HONDA

HOND-8D
HONDA

HONDA

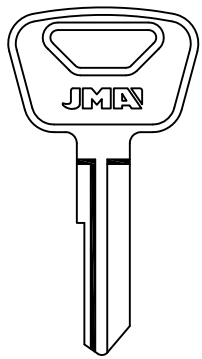

HOND-9I
HONDA

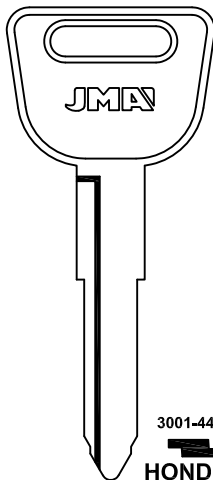

3001-4481
HOND-10

3001-4481
HOND-11
ACURA-HONDA-ROVER

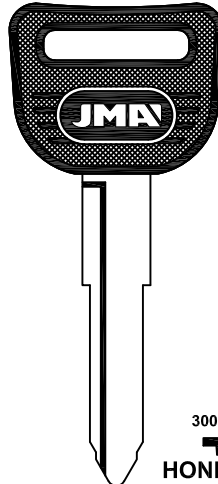

3001-4481
HOND-10.P

3001-4481
HOND-11.P
ACURA-HONDA-ROVER

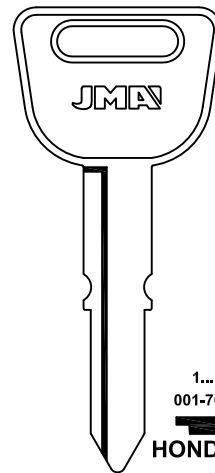

1...
001-700
HOND-12

2...
001-700
HOND-13
HONDA

HONDA

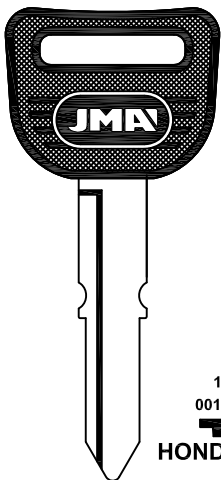

1...
001-700
HOND-12.P

2...
001-700
HOND-13.P
HONDA

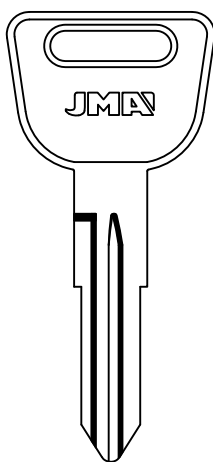

5001-8442
HOND-14
HONDA

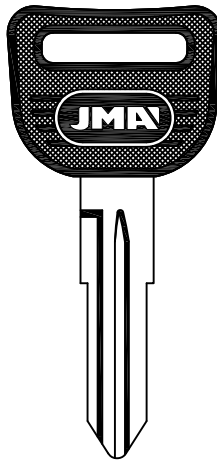

5001-8442
HOND-14.P
HONDA

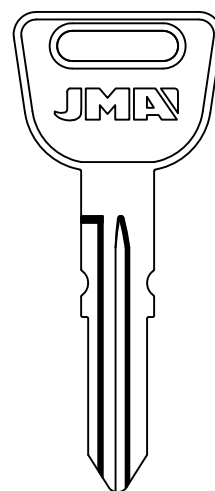

5001-8442
HOND-15
ACURA-HONDA



PARA-FOR:

HONDA (J)

HONDA

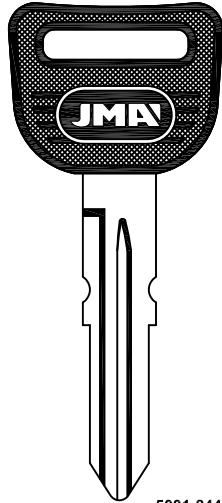

5001-8442
HOND-15.P
ACURA-HONDA

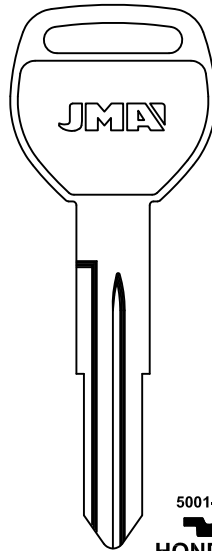

5001-8442
HOND-16D
ACURA-HONDA

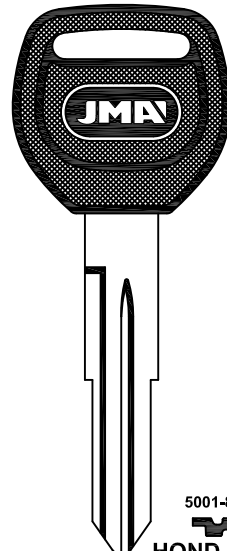

5001-8442
HOND-16D.P
ACURA-HONDA

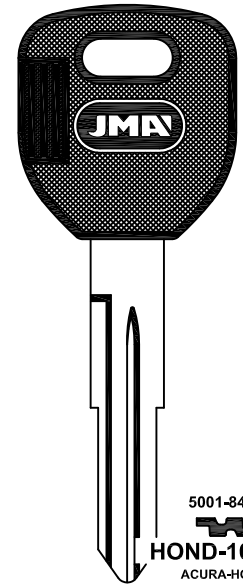

5001-8442
HOND-16D.P1
ACURA-HONDA

HONDA

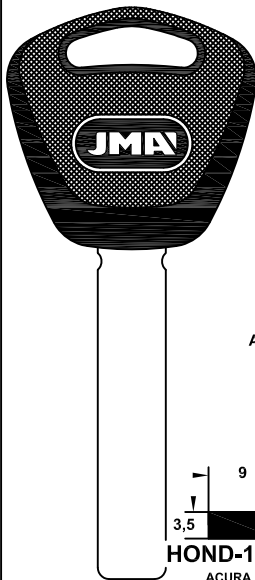

ALP.
3,5 9
HOND-17.P
ACURA

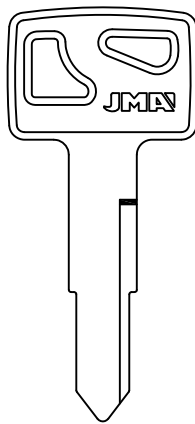

...A00-A99
...B00-B99
HOND-19
HONDA

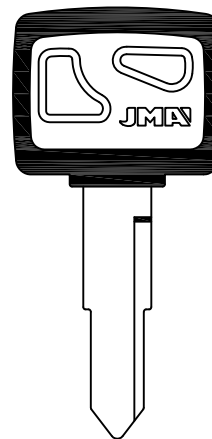

...A00-A99
...B00-B99
HOND-19.P
HONDA

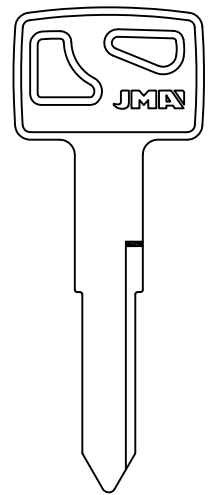

...C00-C99
...D00-D99
.....1 AL 3
...J00-J39
HOND-20
HONDA

HONDA

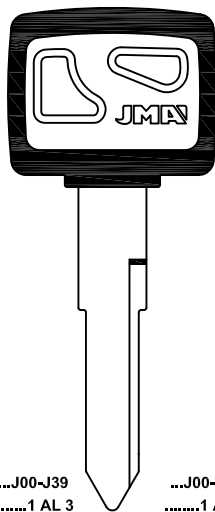

...J00-J39
.....1 AL 3
HOND-20.P
HONDA

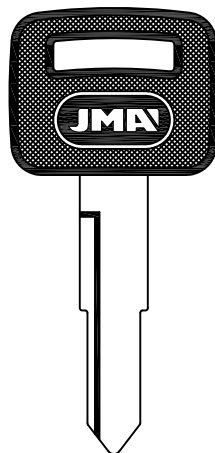

HOND-22D.P
HONDA

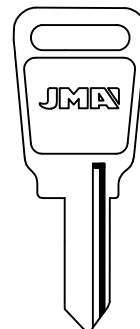

HOND-23

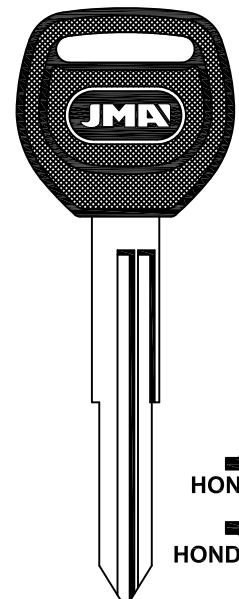

HOND-24.P
HOND-24D.P



HONDA

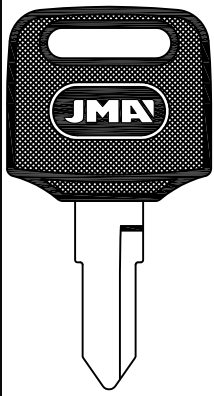

HOND-26.P1

HOND-26D.P1

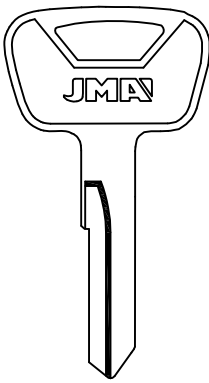

HOND-27D

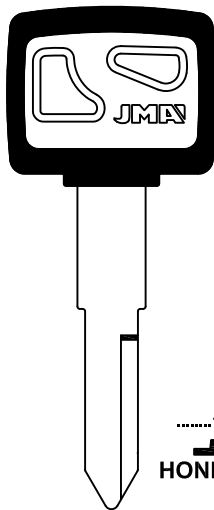

.....1 AL 3
HOND-28.P
HOND-28D.P
HONDA

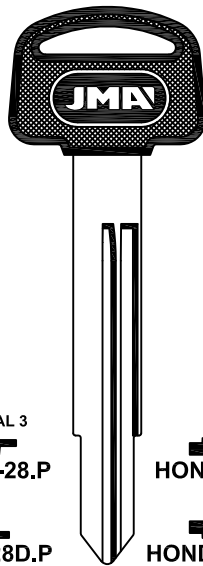

HOND-29.P

HOND-29D.P

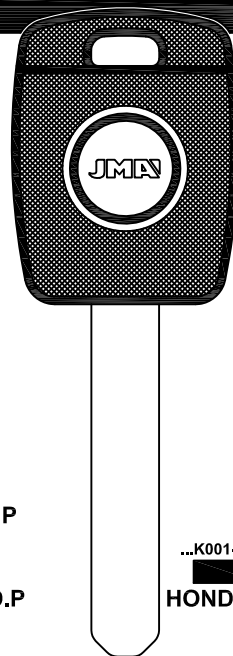

ALP.

...K001-N718
HOND-31.P

PARA-FOR:
HONDA (J)
HUDSON (USA)
HUF (D)

HONDA

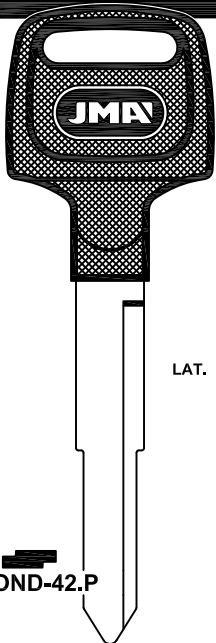

LAT.

HOND-42.P

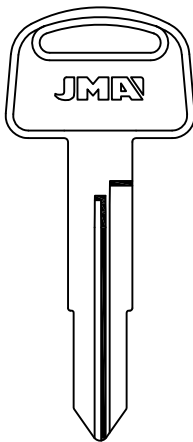

A..00-99
HOND-43

HOND-43D

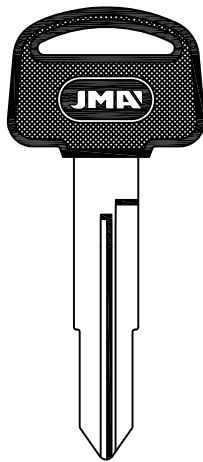

A..00-99
HOND-43.P

HOND-43D.P

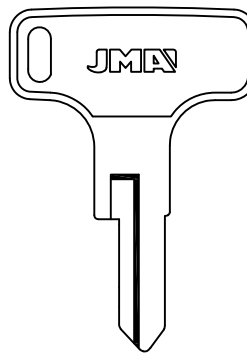

30B-34A
H....0-7-8-9
HOND-49

20B-24A
H....0-4-5-6
HOND-45D

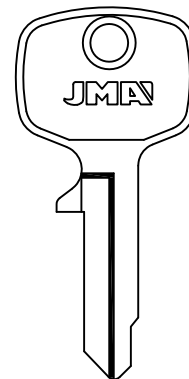

HOND-46D

HUDSON

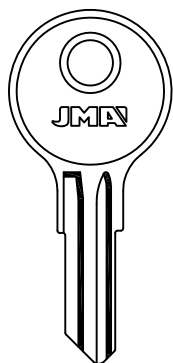

A....201-1050
C...500-699
H....601-1100
HM....201-1050

HUD-1



HUD-1D

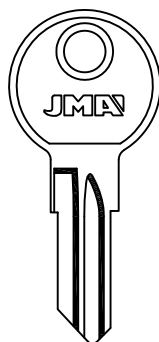

HUD-2D

HUF

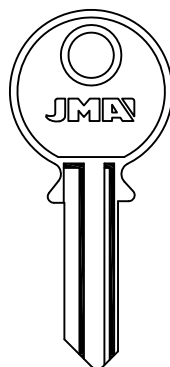

48-I

48-D

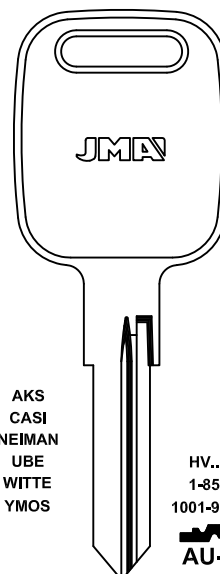

AKS
CASI
NEIMAN
UBE
WITTE
YMOS

HV....
1-854
1001-9282

AU-1

AUDI
VOLKSWAGEN-SCANIA

JMA[®]

Copyright by Alejandro Altuna S.A. 2014



ATENCIÓN: Concerniente a las marcas y denominaciones comerciales ver nota en índice.
ATTENTION: Concerning the marks and commercial denominations see note in index.
ATTENTION: Concernant les marques et dénominations commerciales voir la note dans l'index.
ACHTUNG: Beziehen auf die marke und handelsname sehen sie die notiz im index.

PARA-FOR:

HUF (D)

HUF

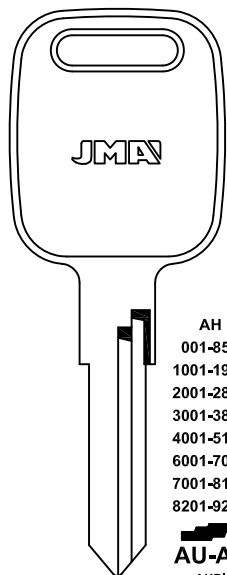

AH
001-854
1001-1918
2001-2830
3001-3890
4001-5151
6001-7086
7001-8154
8201-9282



AU-AH
AUDI
AKS-CASI-UBE-WITTE

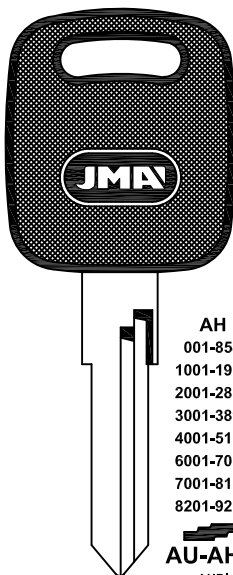

AH
001-854
1001-1918
2001-2830
3001-3890
4001-5151
6001-7086
7001-8154
8201-9282



AU-AH.P
AUDI
AKS-CASI-UBE-WITTE

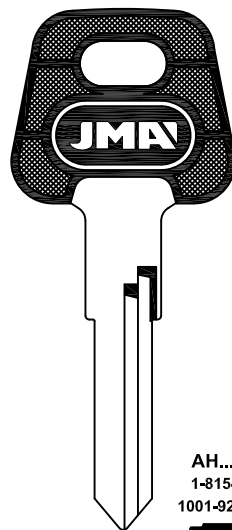

AH...
1-8154
1001-9282



AU-AH.P1
AUDI
WITTE

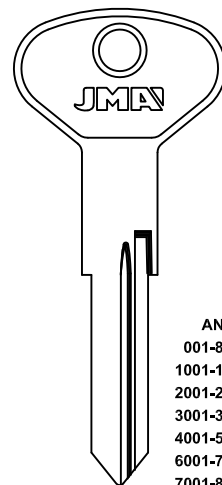

AN
001-854
1001-1918
2001-2830
3001-3890
4001-5151
6001-7086
7001-8154
8201-9282



AU-AN
AUDI-VOLKSWAGEN
AKS-CASI-UBE-WITTE

HUF

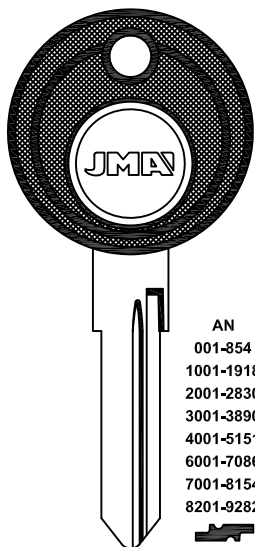

AN
001-854
1001-1918
2001-2830
3001-3890
4001-5151
6001-7086
7001-8154
8201-9282



AU-AN.P
AUDI-FORD-PORSCHE-VOLKSWAGEN
AKS-CASI-UBE-WITTE

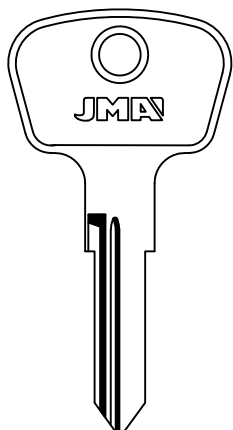

C
01-32/01-62



AU-C
AUDI
AKS

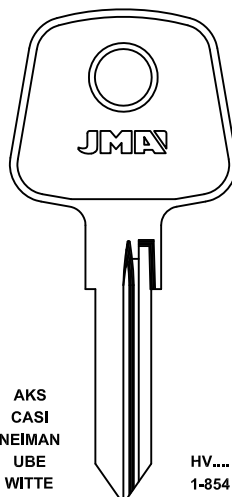

AKS
CASI
NEIMAN
UBE
WITTE
YMOS

HV...
1-854
1001-9282



AU-HV
AUDI-VOLKSWAGEN-SCANIA

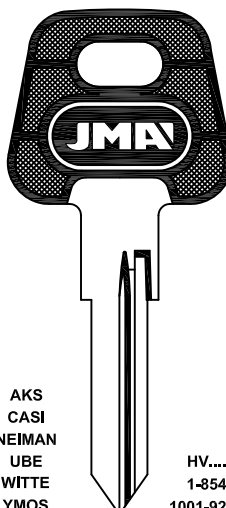

AKS
CASI
NEIMAN
UBE
WITTE
YMOS

HV...
1-854
1001-9282



AU-HV.P
AUDI-VOLKSWAGEN-SCANIA

HUF

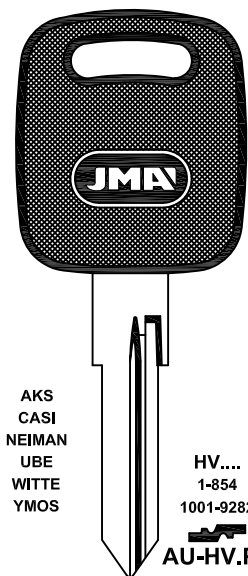

AKS
CASI
NEIMAN
UBE
WITTE
YMOS

HV...
1-854
1001-9282



AU-HV.P1
AUDI

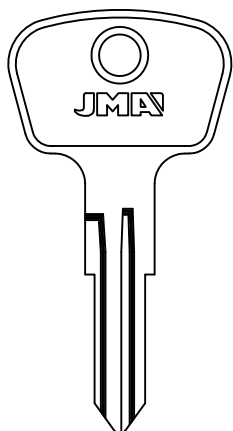

W
11-91/11-91



AU-W
AUDI-VOLKSWAGEN
AKS-WITTE

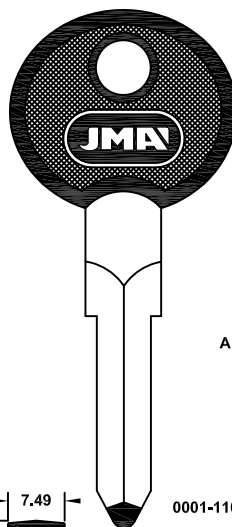

ALP.

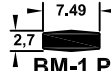

BM-1.P

BMW
PEBRA

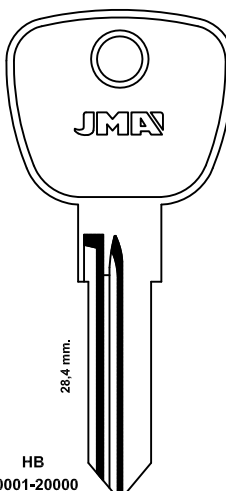

28.4 mm.

HB
10001-20000
40001-49999

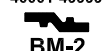

BM-2

BMW



HUF

PARA-FOR:

HUF (D)

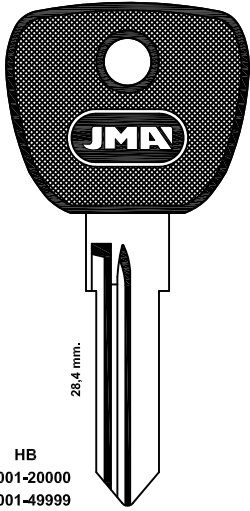

HB
10001-20000
40001-49999

BM-2.P

BMW

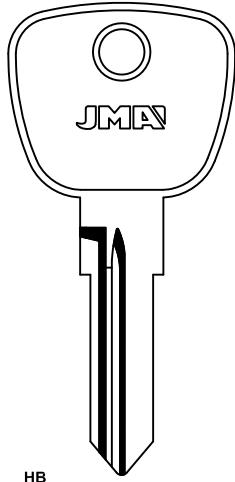

HB
1-5000

BM-3

BMW

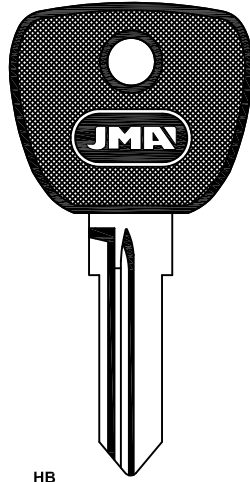

HB
1-5000

BM-3.P

BMW

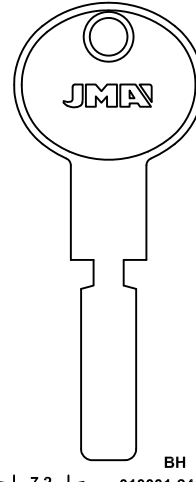

7,2
3,5

BM-4

BMW
TIBBE

BH
010001-241009

HUF

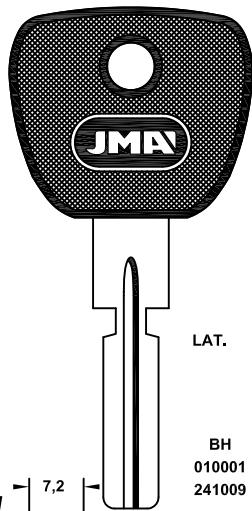

7,2
3,5

BM-5.P

BMW
TIBBE

LAT.

BH
010001
241009

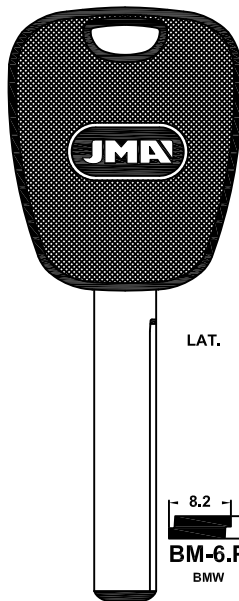

8,2
2,95

BM-6.P

BMW

LAT.

PARA
FOR
BM-6RKE
TP



8,2
2,95

BM-6.P1C1

BMW

ALP.

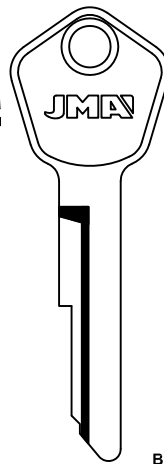

B
101-300
401-630

BM-B

BMW
WITTE

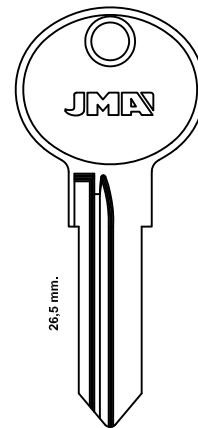

26,5 mm.

HB
1-5000

BM-HB

BMW

NB
1-5000

BM-NB

HUF

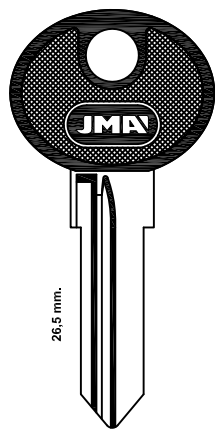

26,5 mm.

HB
1-5000

BM-HB.P

BMW

NB
1-5000

BM-NB.P

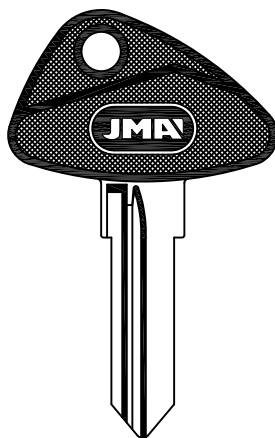

H....P
12353-53425

BM-HB.P1

NEIMAN

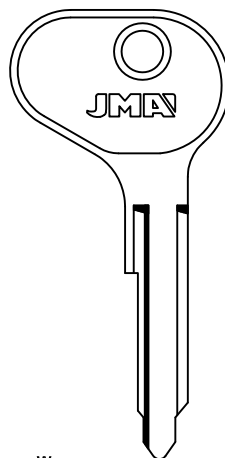

W
1001-2020
7001-8000

BM-W

BMW



....1-4000

FO-24C1

ALP.



PARA-FOR:

HUF (D)

HUF



ALP.

...1-4000
FO-24C2

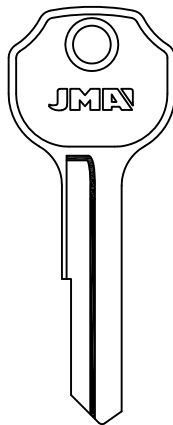

KST...1-240
ST...1-240
TST...1-240
FO-SR
FORD EUROPA

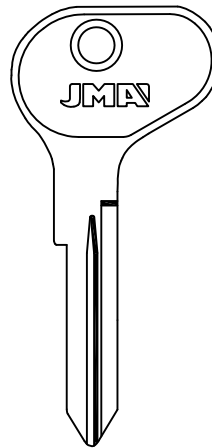

HU-1

NEIMAN-WITTE-YMOS

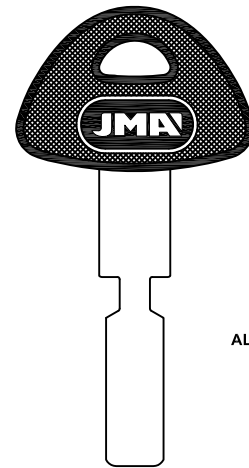

ALP.

...
1-2000
7,6
3,5
HU-2.P
SCANIA

HUF

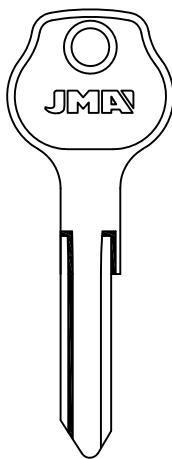

Z
HU-3

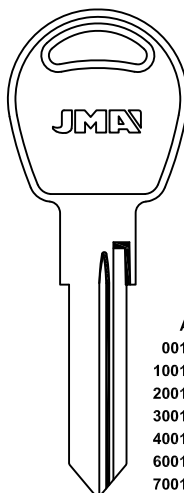

AN
001-854
1001-1918
2001-2830
3001-3890
4001-5151
6001-7086
7001-8154
8201-9282
HU-AN

VOLKSWAGEN
AKS-CASI-UBE-WITTE

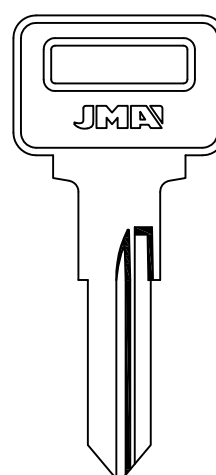

DF-F
0001-1975
HU-DF

VOLVO

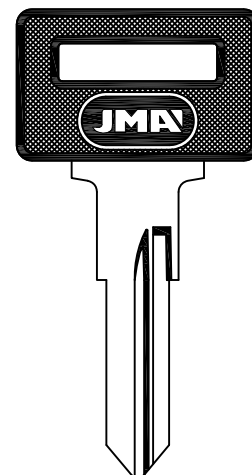

DF-F
0001-1975
HU-DF.P

VOLVO

HUF

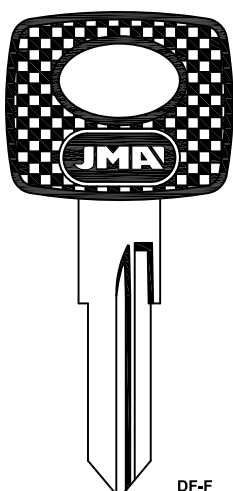

DF-F
0001-1975
HU-DF.P1
VOLVO

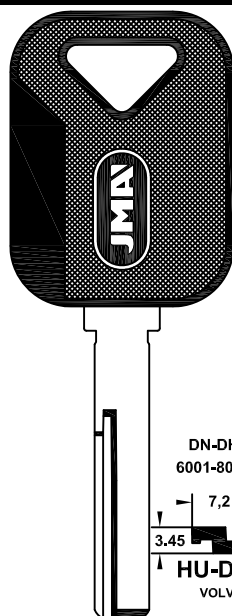

LAT.

DN-DH
6001-8000
7,2
3,45
HU-DH.P
VOLVO

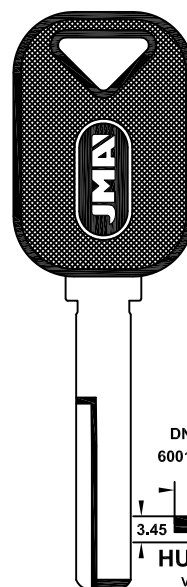

LAT.

DN-DH
6001-8000
7,2
3,45
HU-DN.P
VOLVO



ALP.

HU-HAAC1



HUF

PARA-FOR:

HUF (D)

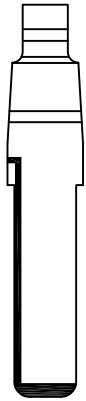

ALP.

HU-HAAC2

HU-NAAC2

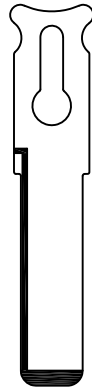

HU-HAAC5

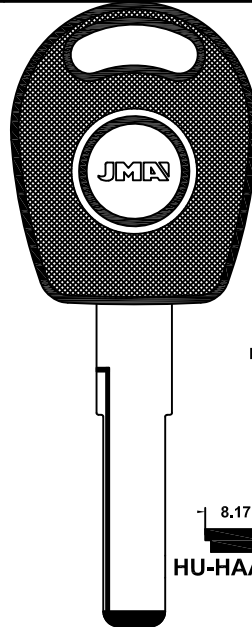

LAT.

HU-HAA.P1

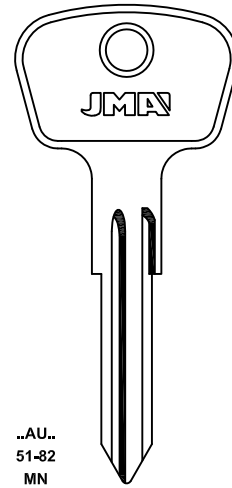

..AU..
51-82
MN
0001-1000
HU-MN

MAN

HUF

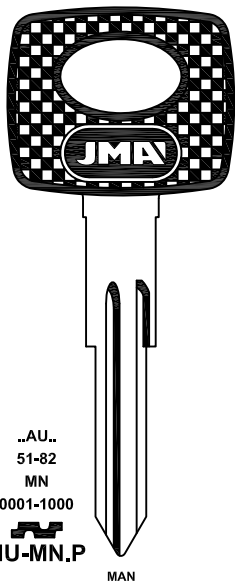

..AU..
51-82
MN
0001-1000
HU-MN.P

MAN

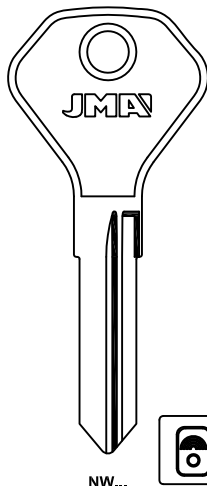

NW...
1-51

HU-NW

BOSCH

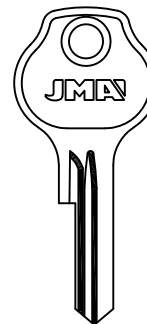

P
001-252
HU-P

VDO

HUF

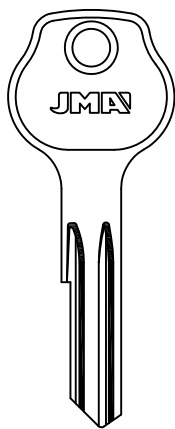

SR
001-240
KSR
001-240
LSR
001-240
TSR
001-240
HU-SR



SZ
1-240
HU-SZ

AKS

SU
001-240
401-630
HU-SU

SX
001-240
HU-SX

SY
001-240
HU-SY

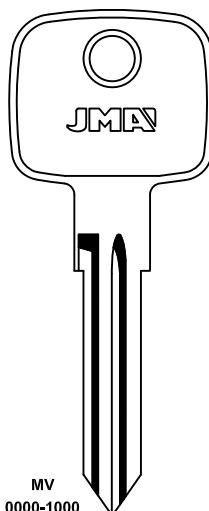

MV
0000-1000
ME-1

MERCEDES
CLAUSOR

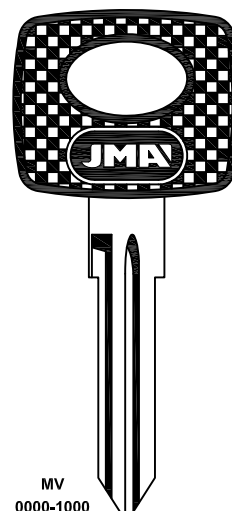

MV
0000-1000
ME-1.P

MERCEDES
CLAUSOR



PARA-FOR:

HUF (D)

HUF

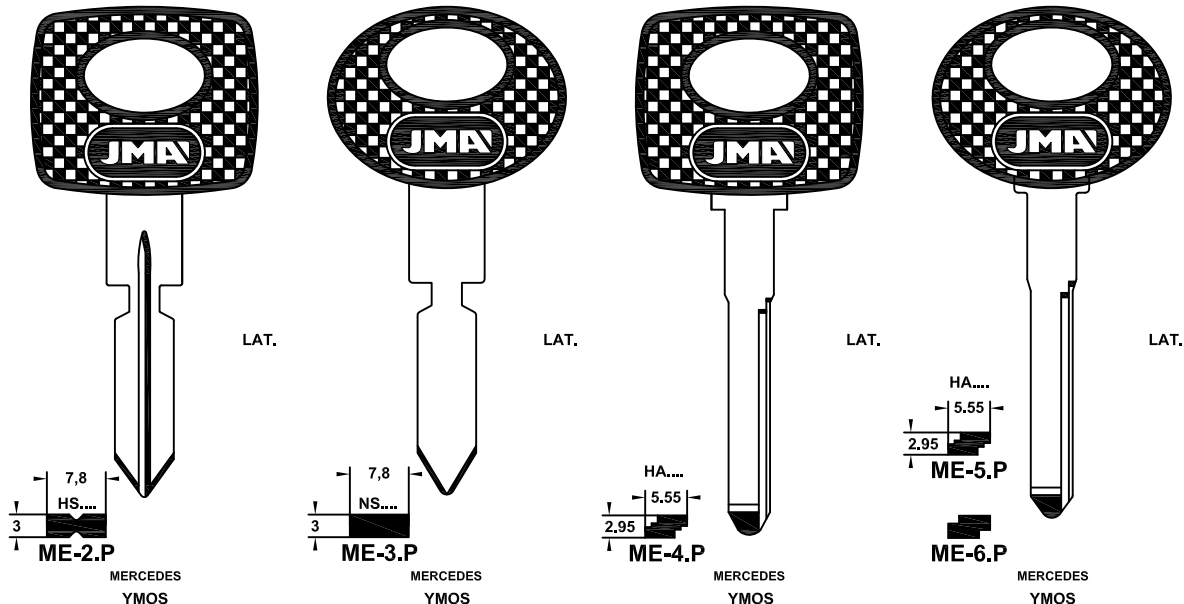

HUF



HUF

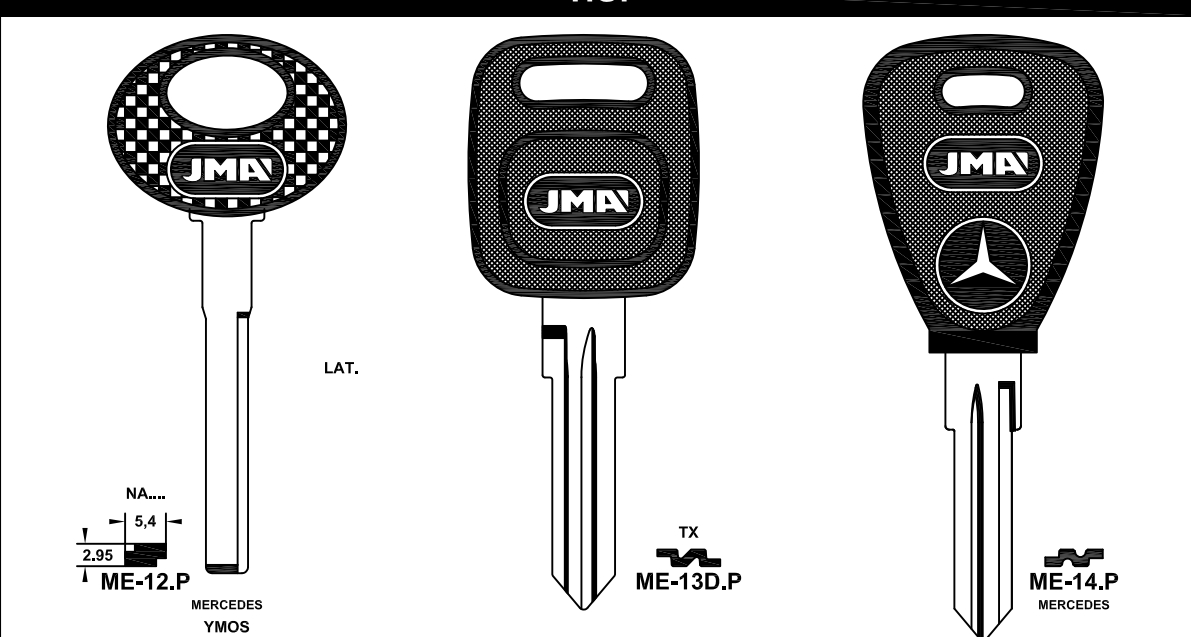

HUF

PARA-FOR:

HUF (D)

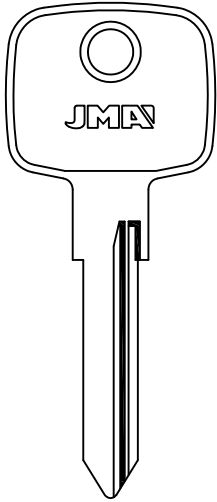

HD 4001-7350
 NZ 0001-1400
 NZ 2001-2500
 NZ 1-99/1-99

ME-HD

HZ 0001-1400
 HZ 2001-3500
 HZ 4001-5000
 ND
 4001-5795
 5801-7350
 HZ 1-99/1-99

ME-HZ

MERCEDES-STEYR PUCH
 YMOS

..HF..
 1-99/1-99

HF 0001-1200
 NM....
 0001-1200
 4001-7350

ME-HF

HM 0001-1200
 2501-3500
 4001-5795
 5801-7350
 NF 0001-1200
 ..NF..
 1-99/1-99

ME-HM

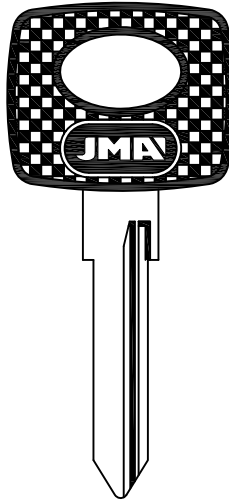

HD 4001-7350
 NZ 0001-1400
 NZ 2001-2500
 NZ 1-99/1-99

ME-HD.P

HZ 0001-1400
 HZ 2001-3500
 HZ 4001-5000
 ND
 4001-5795
 5801-7350
 HZ 1-99/1-99

ME-HZ.P

MERCEDES-STEYR PUCH
 YMOS

..HF..
 1-99/1-99

HF 0001-1200
 NM....
 0001-1200
 4001-7350

ME-HF.P

HM 0001-1200
 2501-3500
 4001-5795
 5801-7350
 NF 0001-1200
 ..NF..
 1-99/1-99

ME-HM.P

HUF

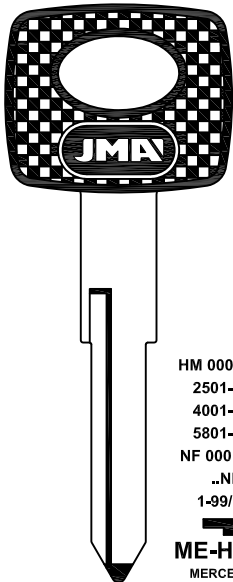

HM 0001-1200
 2501-3500
 4001-5795
 5801-7350
 NF 0001-1200
 ..NF..
 1-99/1-99

ME-HML.P

MERCEDES
 YMOS

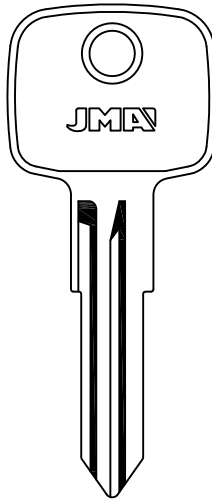

HU
 6001-8130

ME-HU

NU
 6001-8130

ME-NU

MERCEDES
 YMOS

HY
 6001-8130

ME-HY

NY
 6001-8130

ME-NY

HUF

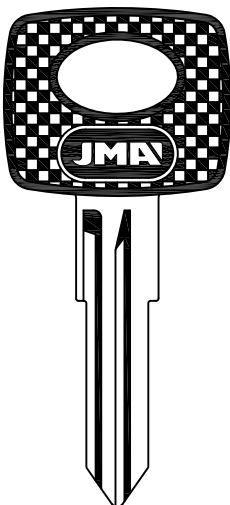

HU
 6001-8130

ME-HU.P

NU
 6001-8130

ME-NU.P

MERCEDES
 YMOS

HY
 6001-8130

ME-HY.P

NY
 6001-8130

ME-NY.P

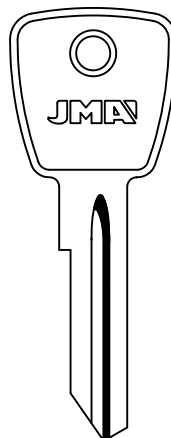

L
 001-300

ME-L

MERCEDES
 IMSA-YMOS

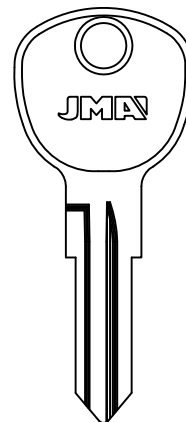

S
 101-295
 401-465
 501-695

ME-S

MERCEDES
 CASI



PARA-FOR:

HUF (D)

HUF

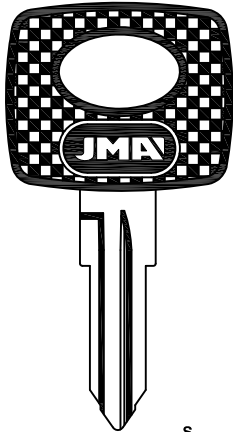
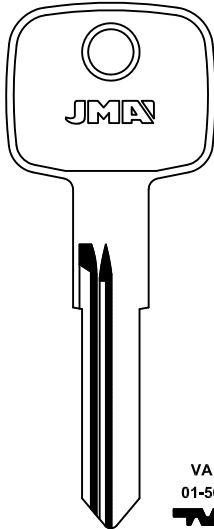
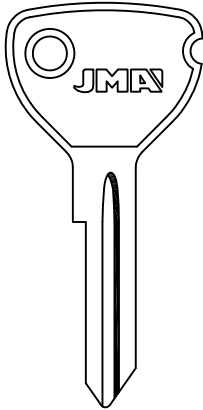
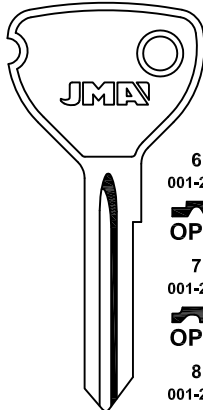
 <p style="text-align: center;">S 101-295 401-465 501-695</p> <p style="text-align: center;">ME-S.P MERCEDES CASI</p>	 <p style="text-align: center;">VA 01-50</p> <p style="text-align: center;">ME-VA HANOMAG-MERCEDES CASI</p>	 <p style="text-align: center;">OP-1</p>	 <p style="text-align: center;">6 001-250 OP-6 7 001-250 OP-7 8 001-250 OP-8 9 001-250 OP-9</p> <p style="text-align: center;">DAEWOO-OPEL-VAUXHALL YMOS</p>
---	---	---	--

HUF

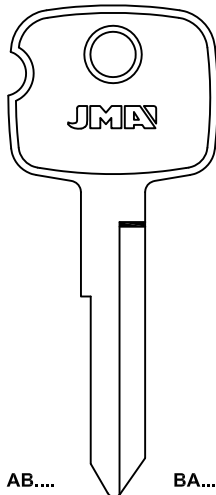
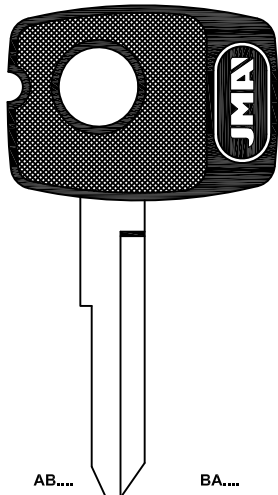
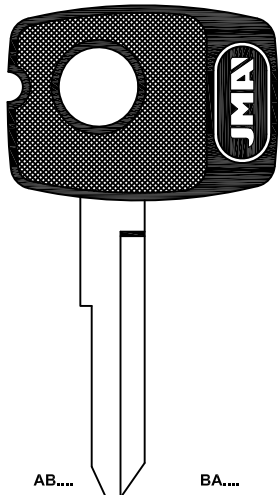
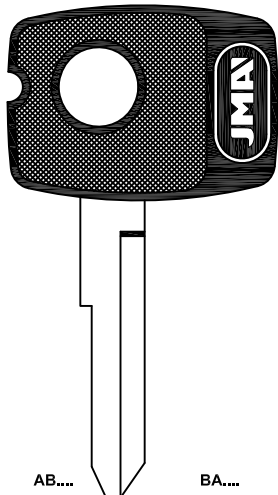
 <p style="text-align: center;">ALP.</p> <p style="text-align: center;">Z...1-2000 Z...2001-4000 Z...4001-6000</p> <p style="text-align: center;">OP-11C1</p>	 <p style="text-align: center;">AB... 1-1000 OP-AB DAEWOO-HOLDEN-OPEL-VAUXHALL YMOS</p>	 <p style="text-align: center;">BA... 1-1000 OP-BA DAEWOO-HOLDEN-OPEL-VAUXHALL YMOS</p>	 <p style="text-align: center;">AB... 1-1000 OP-AB.P DAEWOO-HOLDEN-OPEL-VAUXHALL YMOS</p>	 <p style="text-align: center;">BA... 1-1000 OP-BA.P DAEWOO-HOLDEN-OPEL-VAUXHALL YMOS</p>
--	---	--	--	--

HUF

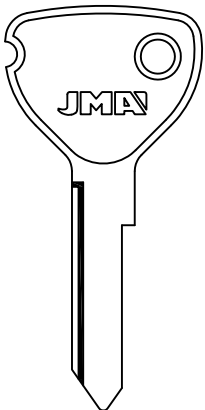
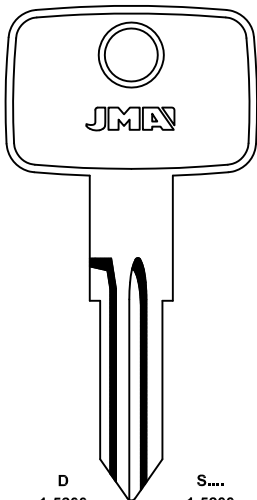
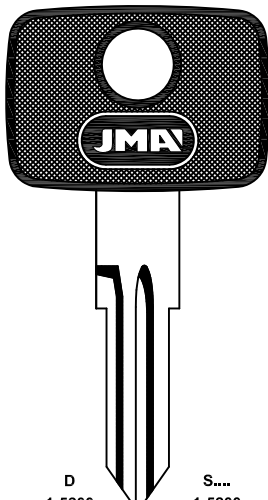





 <p style="text-align: center;">B...1-380 BB...501-1000 BB...1751-2000 BB...2501-3000</p> <p style="text-align: center;">OP-BB DAEWOO-OPEL-VAUXHALL</p>	<p style="text-align: center;">CC...501-1000 CC...1751-2000 CC...2501-3000</p> <p style="text-align: center;">OP-CC</p> <p style="text-align: center;">EE...501-1000 EE...1751-2000 EE...2501-3000</p> <p style="text-align: center;">OP-EE DAEWOO-OPEL-VAUXHALL</p>	<p style="text-align: center;">DD...501-1000 DD...1751-2000 DD...2501-3000</p> <p style="text-align: center;">OP-DD</p> <p style="text-align: center;">FF...501-1000 FF...1751-2000 FF...2501-3000</p> <p style="text-align: center;">OP-FF</p>	 <p style="text-align: center;">D 1-5200 OP-D DAEWOO-GM-LOTUS-OPEL-VAUXHALL YMOS</p> <p style="text-align: center;">S... 1-5200 OP-S DAEWOO-GM-LOTUS-OPEL-VAUXHALL YMOS</p>	 <p style="text-align: center;">D 1-5200 OP-D.P DAEWOO-GM-LOTUS-OPEL-VAUXHALL YMOS</p> <p style="text-align: center;">S... 1-5200 OP-S.P DAEWOO-GM-LOTUS-OPEL-VAUXHALL YMOS</p>
---	--	---	---	--



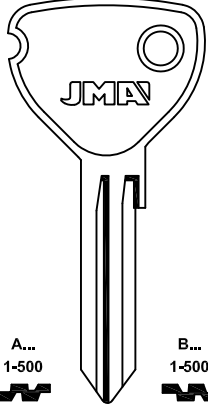
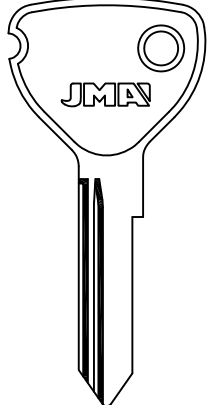
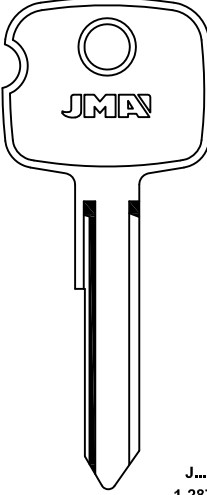
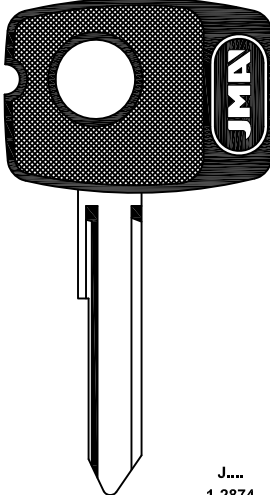



HUF

PARA-FOR:



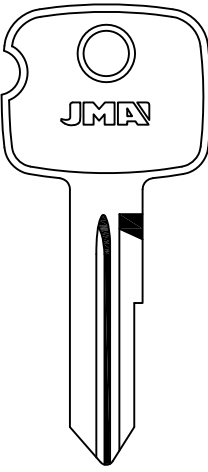
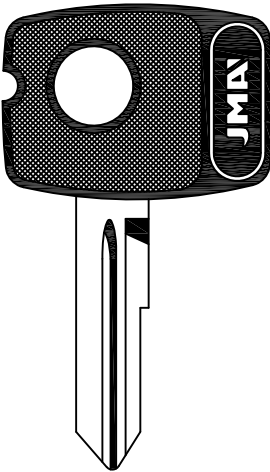
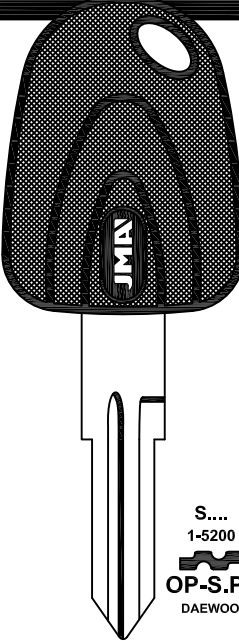
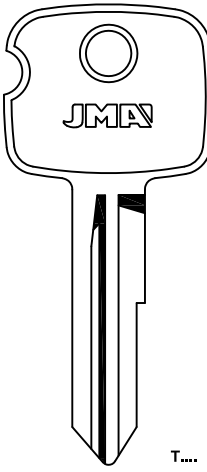



HUF (D)

			
A... 1-500  OP-HA	B... 1-500  OP-HB		
A... 1-500  OP-NA	B... 1-500  OP-NB	G...1-250 G...1251-1500  OP-HG	H...1-250 H...1251-1500  OP-HH
OPEL-VAUXHALL YMOS		DAEWOO-HOLDEN-OPEL-VAUXHALL YMOS	

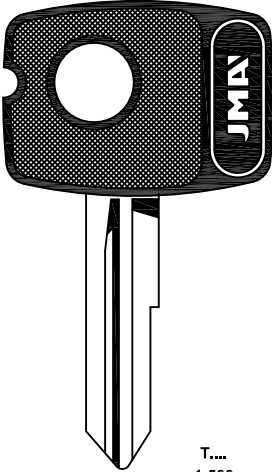
HUF

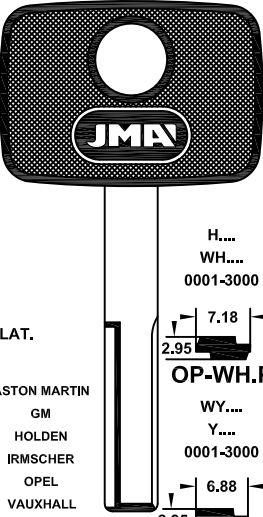
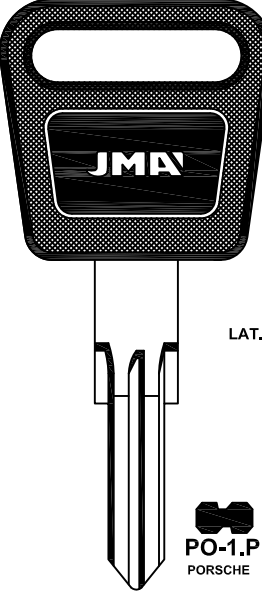
			
R... 1-1500  OP-R	R... 1-1500  OP-R.P	S... 1-5200  OP-S.P1	T... 1-500 501-1500  OP-T
GM-IRMSCHER-OPEL-VAUXHALL YMOS		DAEWOO	GM-IRMSCHER-OPEL-VAUXHALL YMOS

HUF

			
T... 1-500 501-1500  OP-T.P	H... WH... 0001-3000  OP-WHC1	H... WH... 0001-3000  OP-WH.P	LAT.  OP-1.P
GM-IRMSCHER-OPEL-VAUXHALL YMOS		ALP. LAT. ASTON MARTIN GM HOLDEN IRMSCHER OPEL VAUXHALL YMOS	LAT. PORSCHE



PARA-FOR:

HUF (D)

HUF

36,5 mm. LAT.

PO-2.P
PORSCHÉ

HC....
0001-2080
PO-HC
NC....
0001-2080
PO-NC
PORSCHÉ
DOM

HC....
0001-2080
PO-HC.P
NC....
0001-2080
PO-NC.P
PORSCHÉ
DOM

AKS
CASI
NEIMAN
UBE
WITTE
YMOS

AH....
1-8154
1001-9282
SE-AH.P
SEAT

HUF

...124-197
...501-598
...701-790
...G06-G10
...0G1-1G0
A...101-125
A...701-790
G...001-100

SE-AN
SEAT

VO-1
FIAT IVECO
NEIMAN

AH....
1-8154
1001-9282
VO-2
VOLKSWAGEN
AKS-CASI-UBE-WITTE

AH....
1-8154
1001-9282
VO-2.P
2FF
VO-8.P
VOLKSWAGEN
AKS-CASI-UBE-WITTE

VO-2D.P

HUF

AH....
1-8154
1001-9282
VO-2.P1
2FF
VO-8.P1
VOLKSWAGEN BRASIL

VO-2D.P1

AN
001-854
1001-1918
2001-2830
3001-3890
4001-5151
6001-7086
7001-8154
8201-9282
VO-5.P
CASI-HUF-UBE-WITTE

VO-6D



HUF

PARA-FOR:

HUF (D)

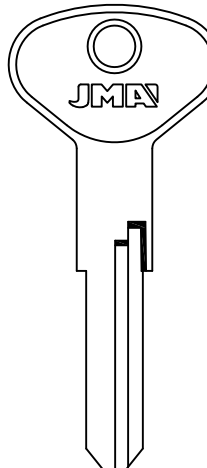

AH...
1-8154
1001-9282

 VO-AH

HV...
1-8154
1001-9282

 VO-HV

VB-NV-MD...
1-8154
1001-9282

 VO-VB

N...
 VO-N



AN...
001-854
1001-1918
2001-2830
3001-3890
4001-5151
6001-7086
7001-8154
8201-9282

 AU-AN

AUDI-FORD-PORSCHE-VOLKSWAGEN
AKS-CASI-LUBE-WITTE

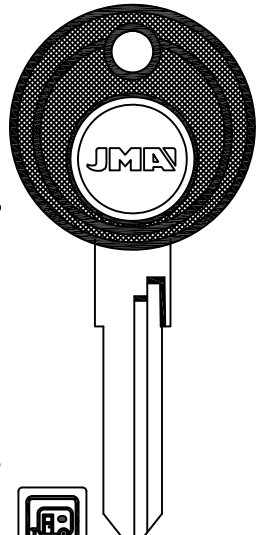

AH...
1-8154
1001-9282

 VO-AH.P

HV...
1-8154
1001-9282

 VO-HV.P

VB-NV-MD...
1-8154
1001-9282

 VO-VB.P

N...
 VO-N.P





AN...
001-854
1001-1918
2001-2830
3001-3890
4001-5151
6001-7086
7001-8154
8201-9282

 AU-AN.P

AUDI-FORD-PORSCHE-VOLKSWAGEN
AKS-CASI-LUBE-WITTE

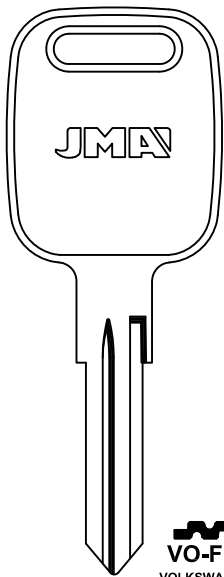
HUF



 VO-FH

VOLKSWAGEN

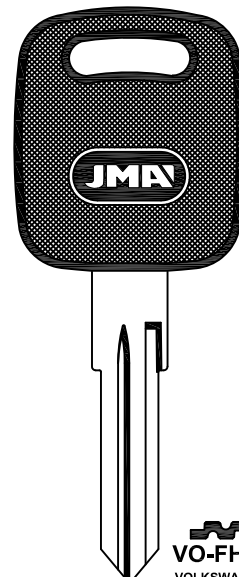

 VO-FH.P

VOLKSWAGEN

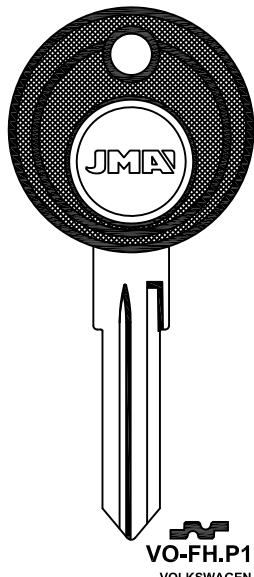

 VO-FH.P1

VOLKSWAGEN

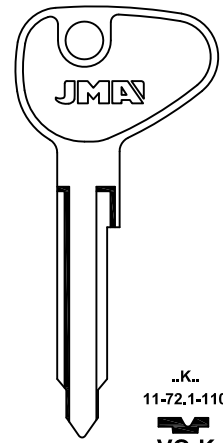

..K...
11-72.1-110

 VO-K

..L...
11-72.1-110

 VO-L

VOLKSWAGEN
NEIMAN-WITTE

HUF

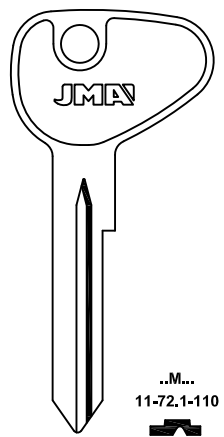

..M...
11-72.1-110

 VO-M



..R...
11-72.1-110

 VO-R

MAN-VOLKSWAGEN
AKS-CASI-WITTE

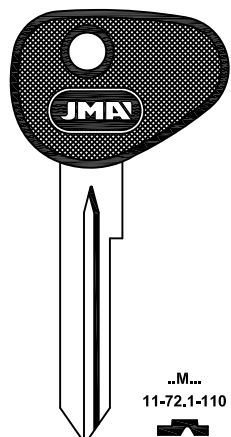

..M...
11-72.1-110

 VO-M.P

..R...
11-72.1-110

 VO-R.P

MAN-VOLKSWAGEN
AKS-CASI-WITTE

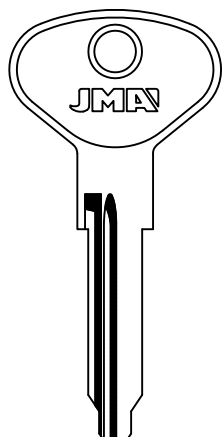

..VA...
01-55

 VO-VA

VOLKSWAGEN

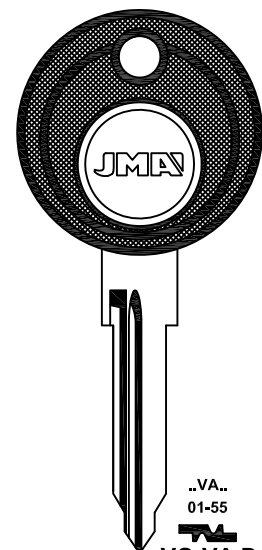

..VA...
01-55

 VO-VA.P

VOLKSWAGEN









PARA-FOR:

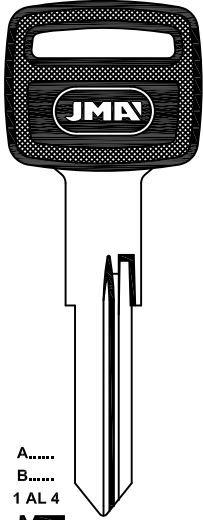
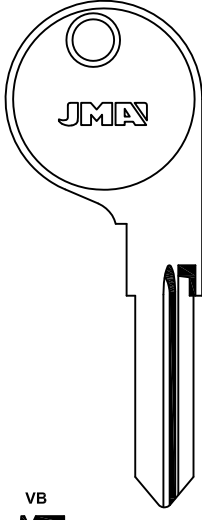
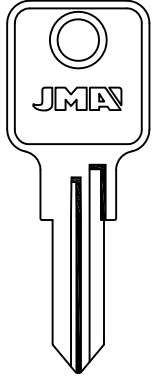
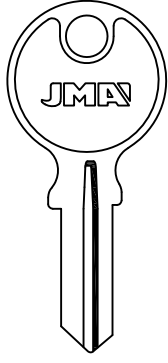





HUF (D)

HUWIL (D)

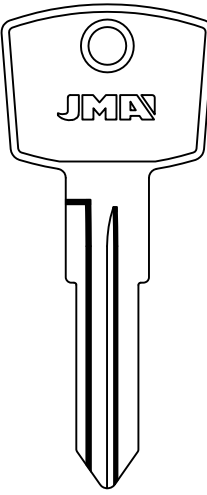
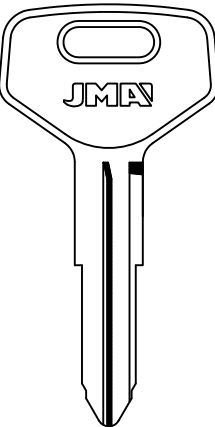
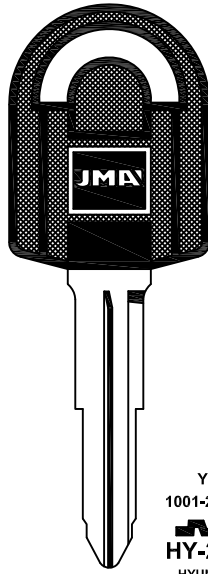
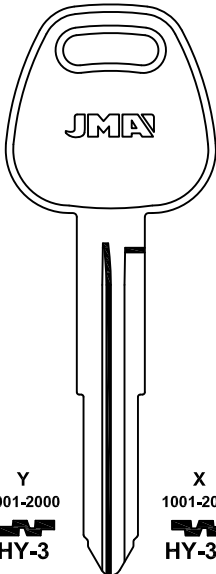





HYUNDAI (K)

HUF		HUWIL	
			
A..... B..... 1 AL 4  VO-VB.P1 NEIMAN	VB  VW-K70	W 3000-4000 A 3001-4000  HUF-1  HUW-1D STRAFOR-STEELCASE	N 0005-1878 N 2001-2204  HUW-N TECNO

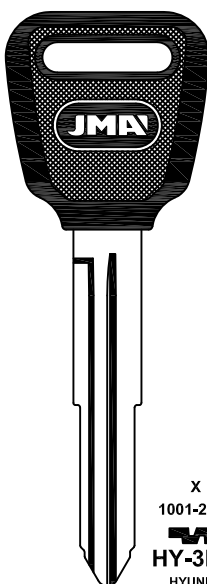
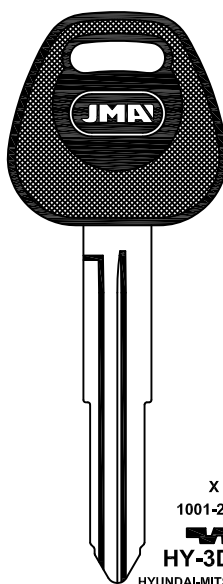
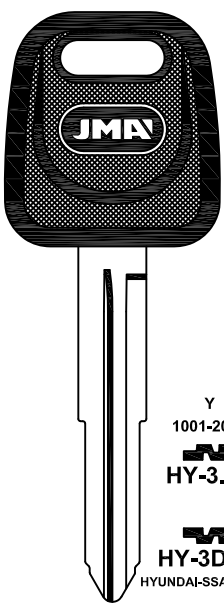
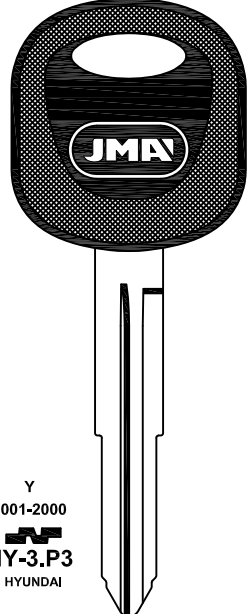
HYUNDAI

			
A/Z.... 0111-0333  HY-1 HYUNDAI	Y 1001-2000  HY-2 HYUNDAI	Y 1001-2000  HY-2.P HYUNDAI	Y 1001-2000  HY-3 HYUNDAI-MITSUBISHI X 1001-2000  HY-3D HYUNDAI-MITSUBISHI

HYUNDAI

			
X 1001-2000  HY-3D.P HYUNDAI	X 1001-2000  HY-3D.P1 HYUNDAI-MITSUBISHI	Y 1001-2000  HY-3.P2  HY-3D.P2 HYUNDAI-SSANGYONG	Y 1001-2000  HY-3.P3 HYUNDAI



HYUNDAI

PARA-FOR:
HYUNDAI (K)

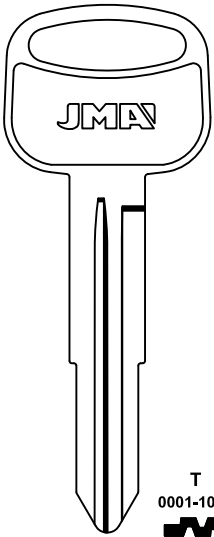

T
0001-1000
HY-4
HYUNDAI

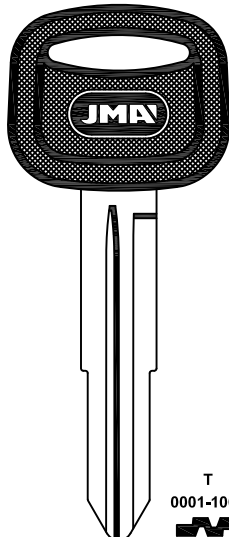

T
0001-1000
HY-4.P
HYUNDAI

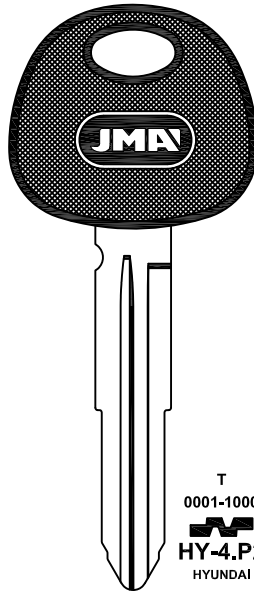

T
0001-1000
HY-4.P2
HYUNDAI

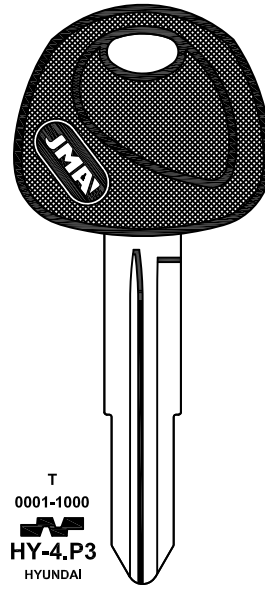

T
0001-1000
HY-4.P3
HYUNDAI

HYUNDAI

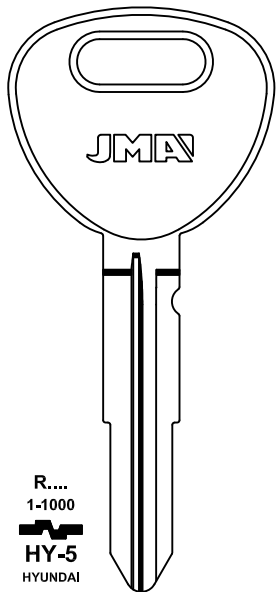

R...
1-1000
HY-5
HYUNDAI

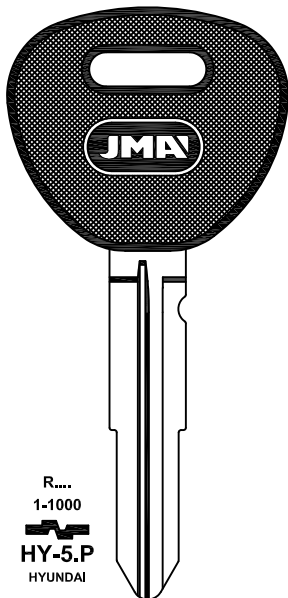

R...
1-1000
HY-5.P
HYUNDAI

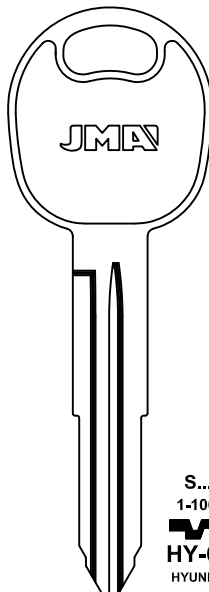

S...
1-1000
HY-6D
HYUNDAI

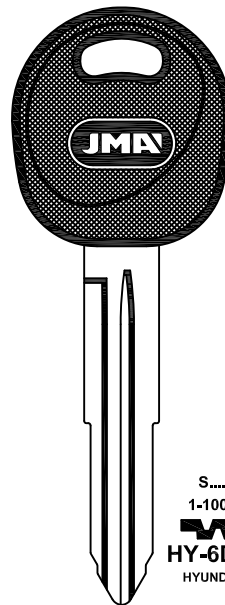

S...
1-1000
HY-6D.P
HYUNDAI

HYUNDAI

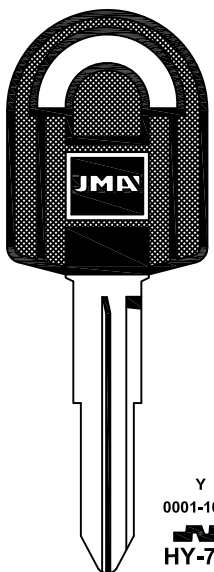

Y
0001-1000
HY-7.P
HYUNDAI

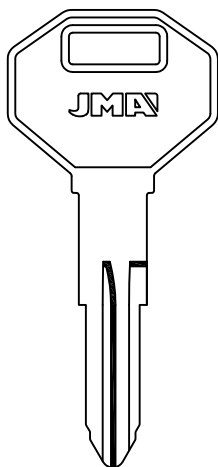

H
1-2000
HY-8
HYUNDAI

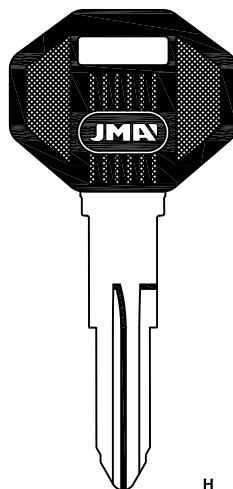

H
1-2000
HY-8.P
HYUNDAI

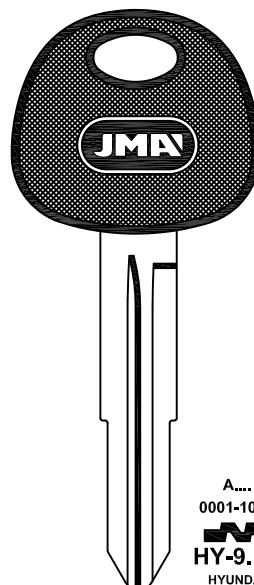

A...
0001-1000
HY-9.P2
HYUNDAI



PARA-FOR:

HYUNDAI (K)

IMSA (E)

HYUNDAI

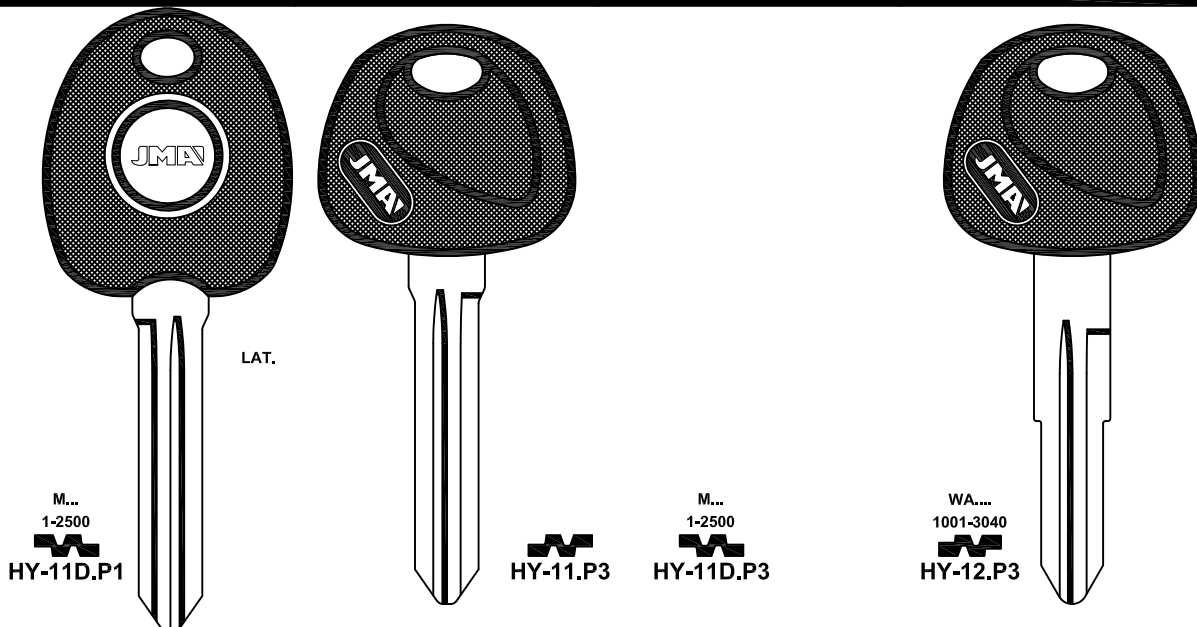

IMSA

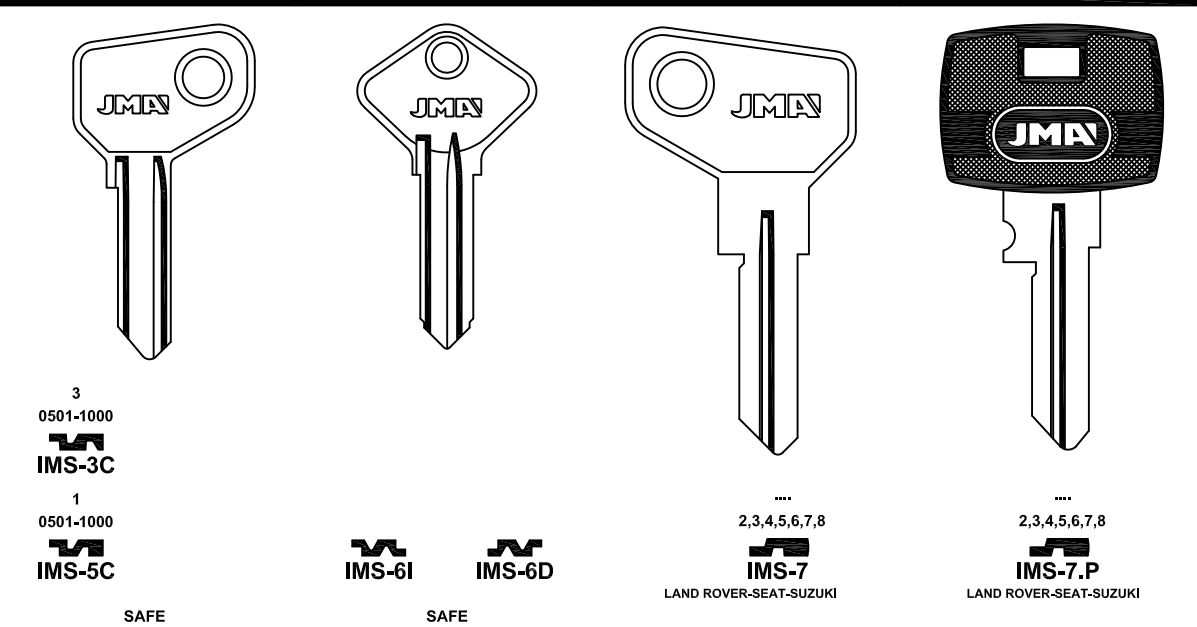

IMSA

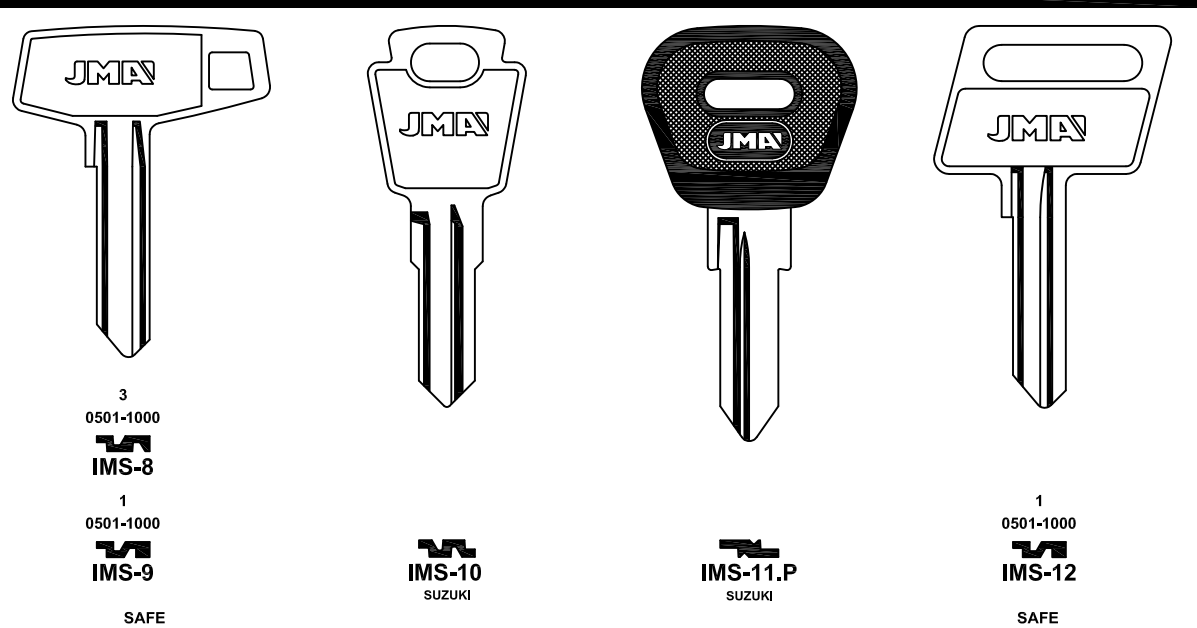

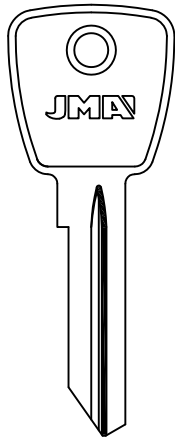
IMSAL
001-300

IMS-MER

SAFE

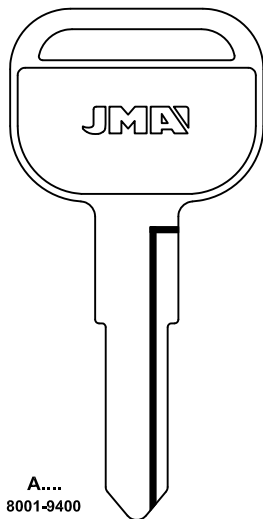
ISUZUA....
8001-9400

ISU-1

ISUZU

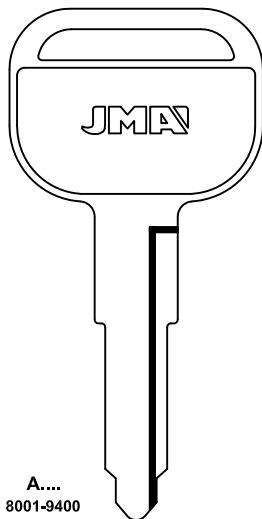
A....
8001-9400

ISU-2

ISUZU

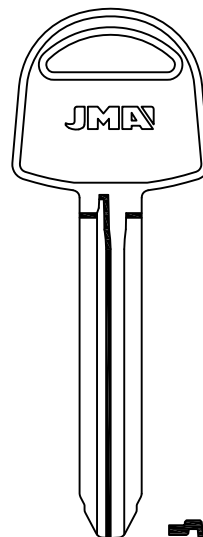

ISU-3D

PARA-FOR:

IMSA (E)

ISUZU (J)

JOHN DEERE
(USA)

KAMAZ (RUS)

KAWASAKI (J)

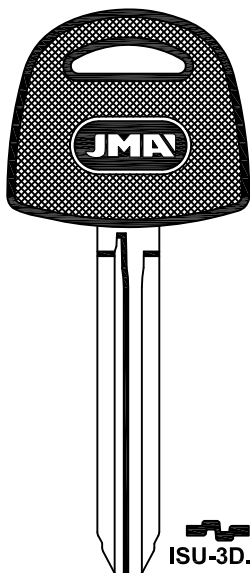
ISUZU

ISU-3D.P

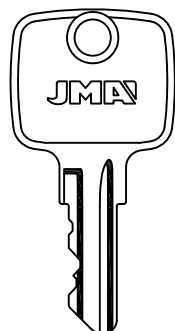
JOHN DEERE

LAT.



JD-1

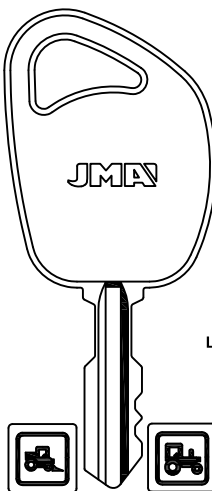

LAT.



JD-2

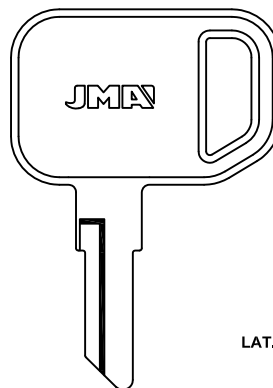

LAT.

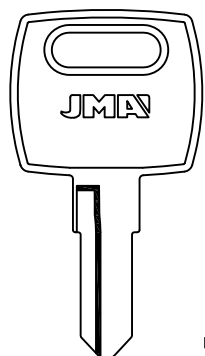

JD-3D

JOHN DEERE

LAT.

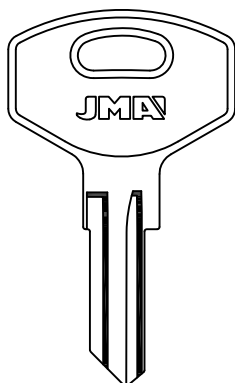

JD-4D

KAMAZ

KAM-1

KAM-1D

ZIL

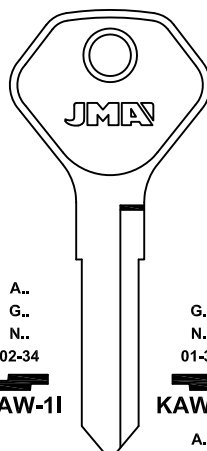
KAWASAKIA..
G..
N..
02-34

KAW-1I

B....
1 AL 4

KAW-2I

KAWASAKI

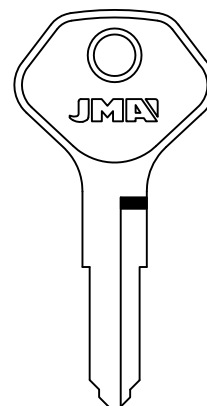
G..
N..
01-35

KAW-1D

A..
G..
N..
1 AL 4

KAW-2D

Z
5000-6000

KAW-3

KAWASAKI



PARA-FOR:

KAWASAKI (J)

KENWORTH
(USA)

KIA (K)

KAWASAKI

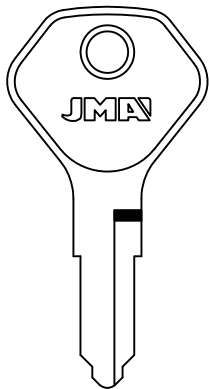

751-795
PLC
401-600

KAW-4
HYUNDAI-KAWASAKI

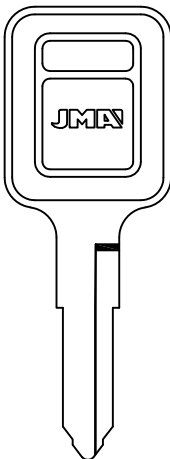

Z....
5000-6000

KAW-5
KAWASAKI

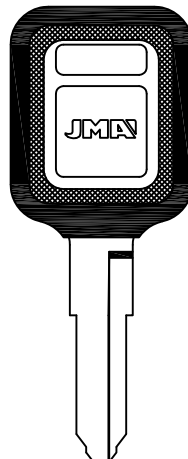

Z....
5000-6000

KAW-5.P
KAWASAKI

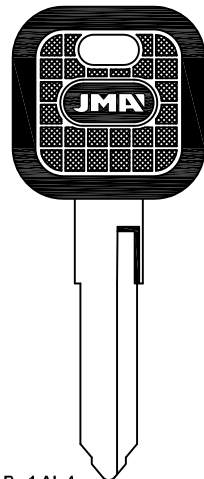

B.. 1 AL 4
H.. 1 AL 4

KAW-6.P **KAW-6D.P**
CAGIVA-DUCATI-KAWASAKI

KAWASAKI

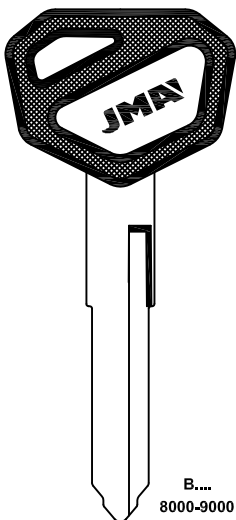

B....
8000-9000

KAW-7.P
KAWASAKI

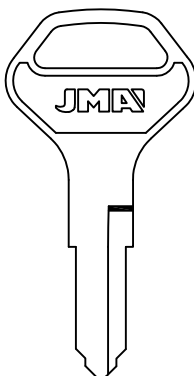

KAW-8 **KAW-8D**

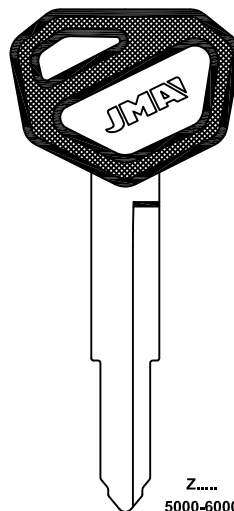

Z....
5000-6000

KAW-9.P
KAWASAKI

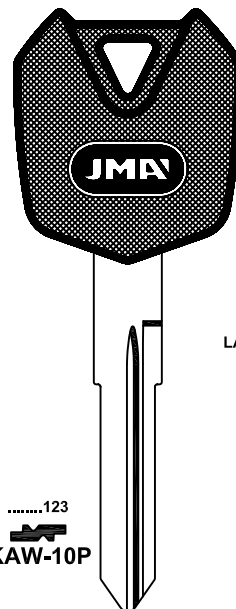

.....123

KAW-10P

LAT.

KENWORTH

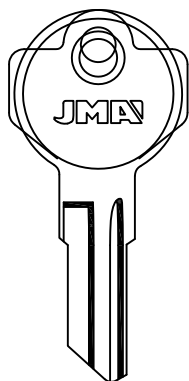

C....
250-499
1701-1950

KEN-1 **KEN-1D**
BASCO

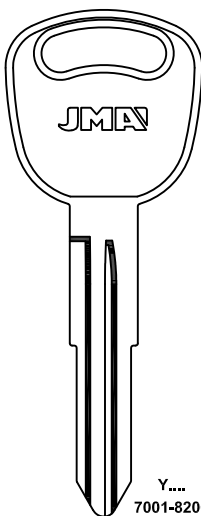

Y....
7001-8200

KI-1D
FORD (AUSTRALIA)-KIA

KIA

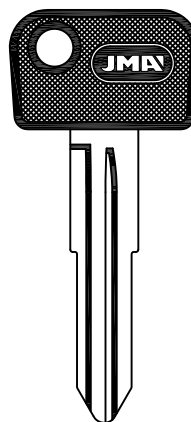

Y....
7001-8200

KI-1D.P

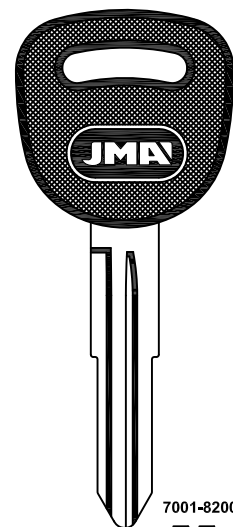

7001-8200

KI-1D.P1
FORD (AUSTRALIA)-KIA



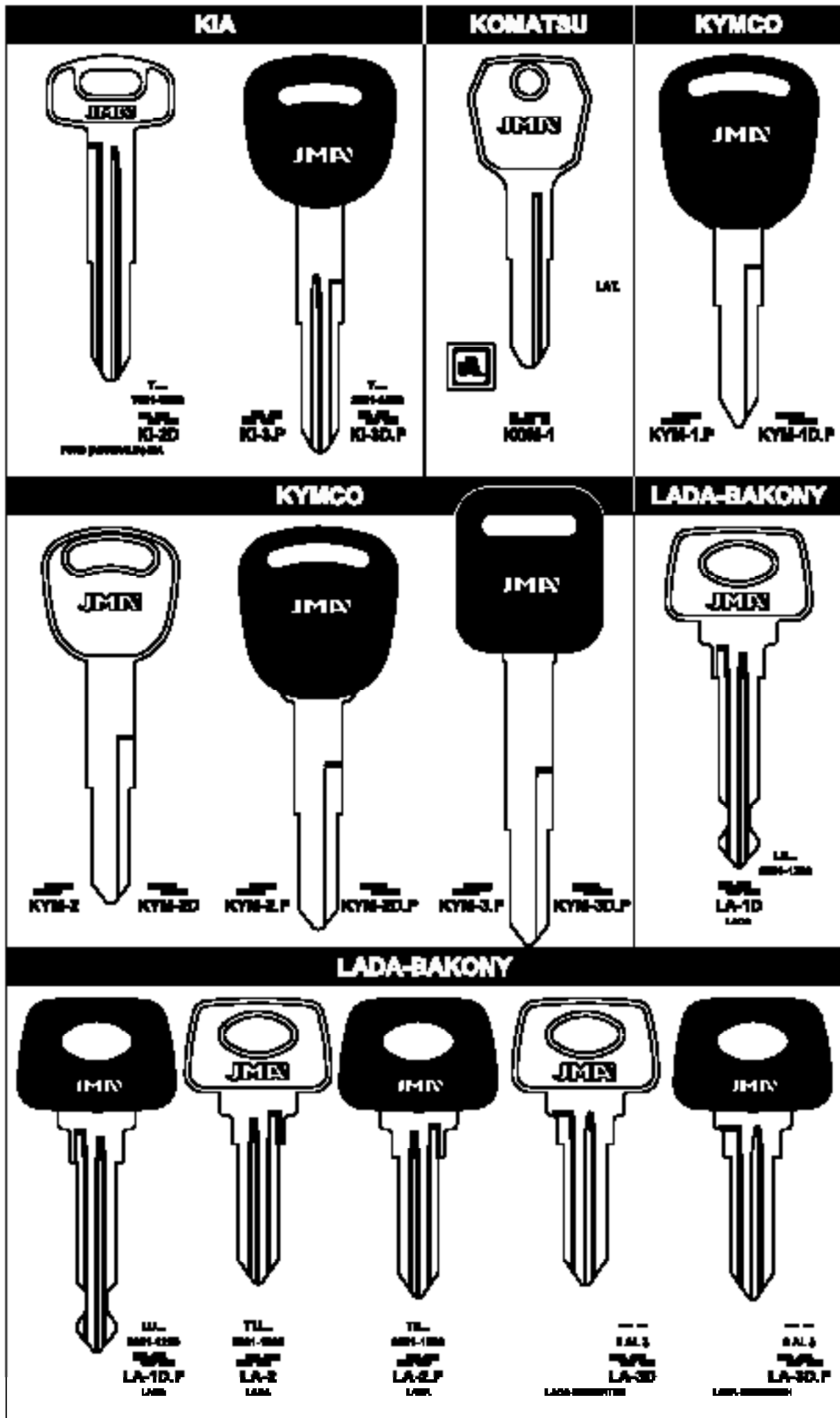

PARA-FOR:
 KIA (K)
 KOMATSU (USA)
 KYMCO (K)
 LADA-BAKONY (RUS)



PARA-FOR:

LADA-BAKONY
(RUS)

LAS (F)

LMP (F)

LADA-BAKONY		LAS	
LU... 0001-1280 LA-4D LADA	LU... 0001-1280 LA-4D.P LADA	AX 001-224 LAS-AX EX LAS-1D	ABBS ATAL DUBOIS ORDO RENZ STRAFOR FH 001-400 501-550 LAS-FH FM 001-400 501-550 LAS-4 LAS-4D
ATAL-HÄFELE-KIFERM-RENZ			

LAS			
FH 001-400 501-550 LAS-3 H LAS-5 U LAS-U	E LAS-5D X LAS-X	TA LAS-6 RM 0001-2000 KT 3001-4000 LAS-KT	AT LAS-6D TK 4001-5000 LAS-TK
KIFERM		ATAL-KIFERM-MARCADET-RONIS	
BT 001-650 LAS-BT	TB 001-650 LAS-TB	CR 001-650 LAS-CR	RC 001-650 LAS-RC
		P 001-224 LAS-P	
		KIFERM-PJ	

LAS		LMP	
R 001-224 LAS-R	V 001-224 LAS-V	XS 01-75 LAS-XS	10055-12538 LMP-1 EBRO-PEUGEOT-RENAULT GELBON-ROS-SEIMA
Y 001-224 LAS-Y	XY 01-75 LAS-XY	SX 01-75 LAS-SX	10055-12538 LMP-1.P EBRO-PEUGEOT-RENAULT GELBON-ROS-SEIMA
DUBOIS-KIFERM-PJ-PK		ATAL-JU-KIFERM-METEOR-RENZ	



LMP

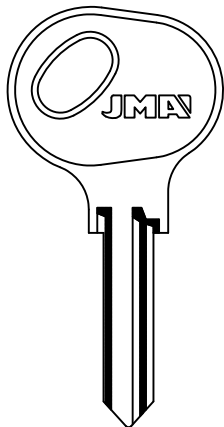

20000-25527
50001-52500



LMP-2

PEUGEOT-RENAULT
GELBON-SEIMA

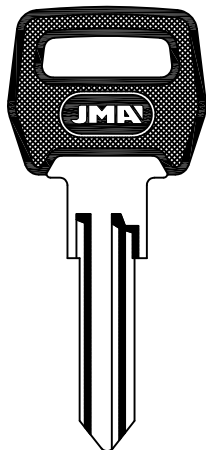

20000-25527
50001-52500



LMP-2.P

PEUGEOT-RENAULT
GELBON-SEIMA

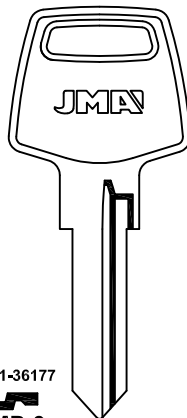

35001-36177



LMP-3

70001-72500
75000-77500
1AA-7FZ



LMP-4

PEUGEOT-RENAULT-TALBOT
GELBON-SEIMA



LMP-5

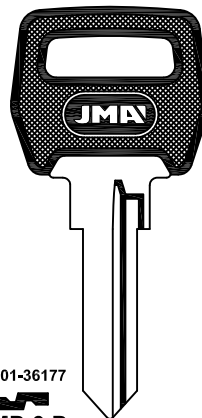

35001-36177



LMP-3.P

70001-72500
75000-77500
1AA-7FZ



LMP-4.P

PEUGEOT-RENAULT-TALBOT
GELBON-SEIMA



LMP-5.P

PARA-FOR:

LMP (F)

LOWE & FLETCHER

(GB)

LMP

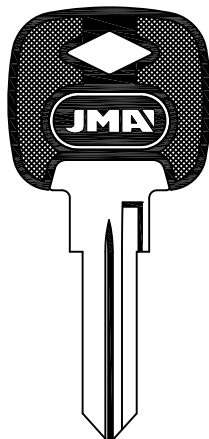

70001-72500
75000-77500
1AA-7FZ



LMP-4.P1



LMP-5.P1

RENAULT
GELBON-SEIMA

LOWE & FLETCHER

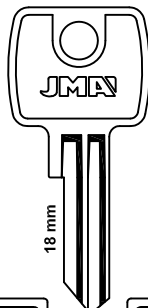

18 mm



90...1-200
...1-400
91...201-275
GH...1-4000
SS...1-400
91...276-350



LF-11



LF-1D

CEM-EURO LOCKS-UNION

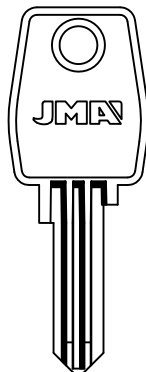

95001-97000
97001-99000



LF-2



LF-12



LF-12D

BICICLETTA CYCLES
DOBLE SAFE-EURO LOCKS

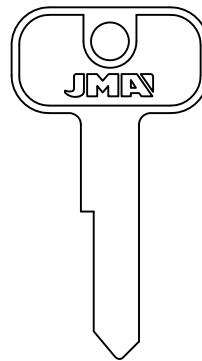

RL-RM
801-952



LF-3

STREBOR

LOWE & FLETCHER

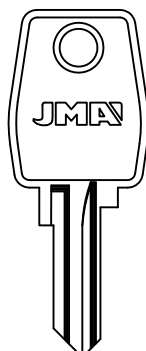

LF-4I

EURO LOCKS

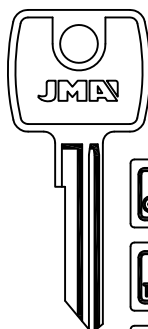

....
70001-71000
M....
70001-71000



LF-5



LF-5D



LF-32

TELFORD

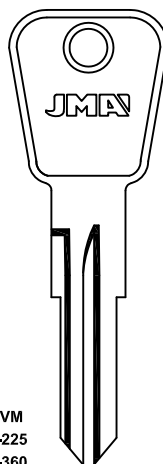

FV-VM
101-225
301-360
VT...
400-474



LF-6

CHRYSLER-VAUXHALL-BEDFORD-FORD

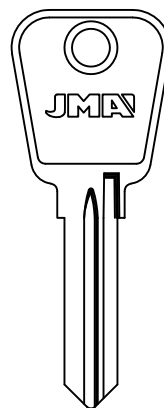

....
66001-67200



LF-7

FORD EUROPA

....
81001-87000



LF-7D



PARA-FOR:
LOWE & FLETCHER
 (GB)

LOWE & FLETCHER

93...201-400
.....93901-94000

LF-8

LF-8D

93...401-900
.....90901-90975

LF-11

LF-11D

EURO LOCKS-MIBRA-UTZ

15001-19000
85001-87000

LF-9

**ROVER-BEDFORD
BRITAX**

60... 001-200
60... 001-200
90... 001-200
...1-400
GHM...1-155
M...1-400
RV...1-400
RVM...1-400
SP...1-400
99...1-400

LF-15

FFE
001-100

LF-17

CEM-EURO LOCKS-ULTRA-UNION

LOWE & FLETCHER

LF-28

EURO LOCKS

LF-39D

EURO LOCKS

BL....
BL....N
1001-2000

LF-BL

BRITAX

AUSTIN
CARBODIES
INNOCENTI
LAND ROVER
LOTUS
MASERATI
OM IVECO
ROVER
VAUXHALL
BEDFORD
FIAT IVECO

RO
BL....N
1001-2000

LF-RO

LOWE & FLETCHER

AUSTIN
CARBODIES
INNOCENTI
LAND ROVER
LOTUS
MASERATI
OM IVECO
ROVER
VAUXHALL
BEDFORD
FIAT IVECO

RO
BL....N
1001-2000

LF-RO.P

SL
5001-7000

LF-SL

**CHRYSLER-FORD (USA)-SUNBEAM
ROOTES**

SL
5001-7000

LF-SL.P

**CHRYSLER-FORD (USA)-SUNBEAM
ROOTES**

WR
1001-2000

LF-WB

**TRIUMPH
WILMOT BREEDEN**



LOWE & FLETCHER

MACK

MARUTI

PARA-FOR:

LOWE & FLETCHER (GB)

MACK (USA)

MARUTI (IND)

MAZDA (J)

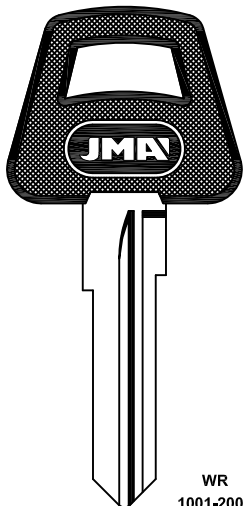

WR
1001-2000
LF-WB.P

TRIUMPH
WILMOT BREEDEN

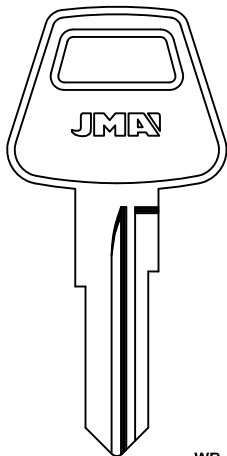

WR
3000-3999
5000-5999
LF-WR

DE LOREAN-FORD (USA)
WILMOT BREEDEN

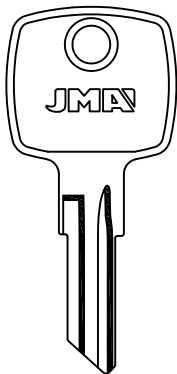

LAT.



MAK-1

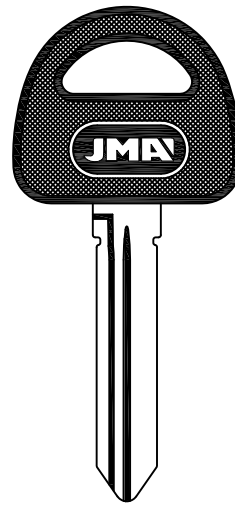

MAR-1.P

MAZDA

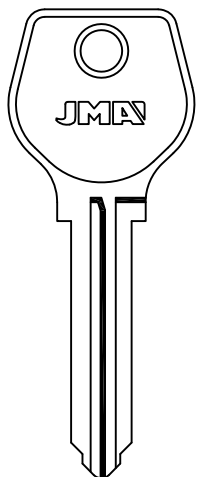

1500-1999
2000-2499
5000-6100

MAZ-1I **MAZ-1D**
FORD (USA)-MAZDA

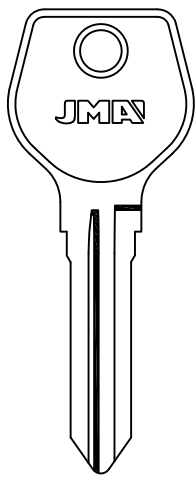

3000-3499
5000-6100
2500-2999
3500-4600

MAZ-2I **MAZ-2D**
FORD (AUSTRALIA)-MAZDA

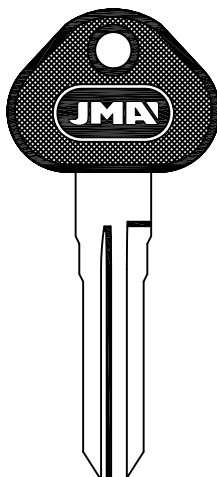

3000-3499
5000-6100
2500-2999
3500-4600

MAZ-2I.P **MAZ-2D.P**
FORD (AUSTRALIA)-MAZDA

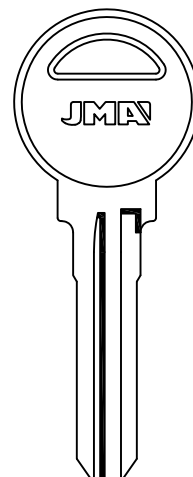

6500-7733

MAZ-3I **MAZ-3D**
MAZDA

MAZDA

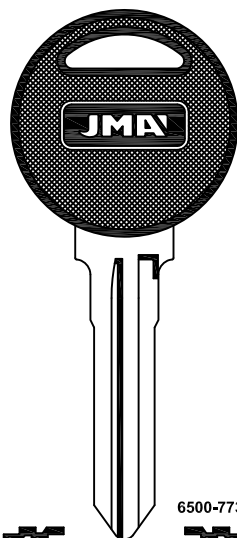

6500-7733

MAZ-3I.P **MAZ-3D.P**
MAZDA

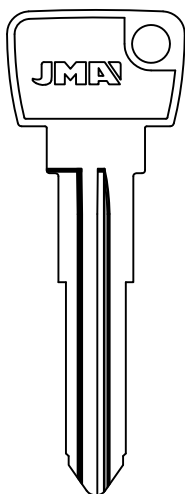

MAZ-4
MAZDA

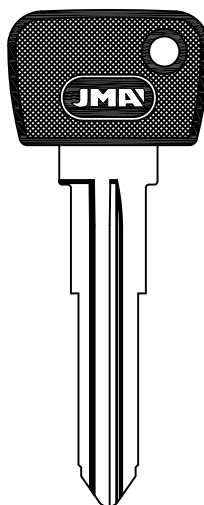

MAZ-4.P
MAZDA

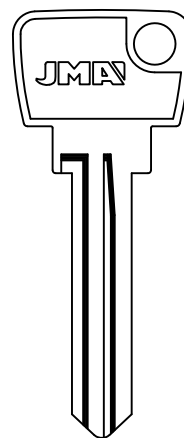

FA....
6500-7733

MAZ-5D
MAZDA



PARA-FOR:

MAZDA (J)

MAZDA

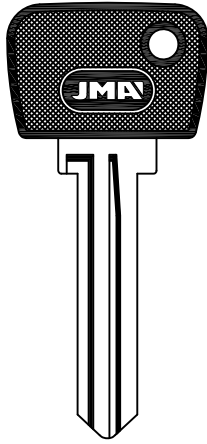

FA...
6500-7733



MAZDA

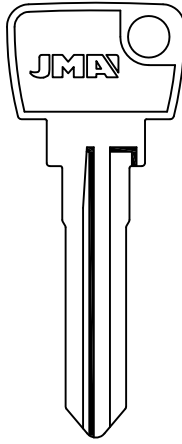

....
6500-7733



MAZ-6

FORD (USA)-MAZDA

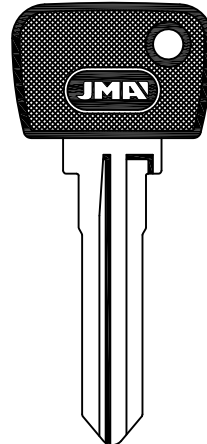

....
6500-7733



MAZ-6.P

FORD (USA)-MAZDA

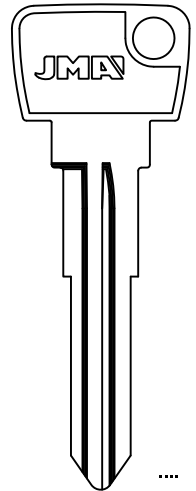

....
10100-12099



MAZ-7D

MAZDA

MAZDA

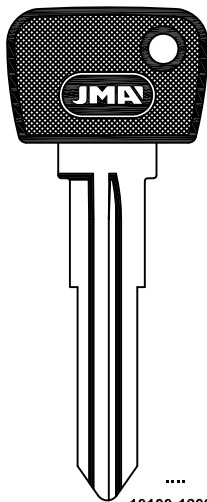

....
10100-12099



MAZ-7D.P

MAZDA

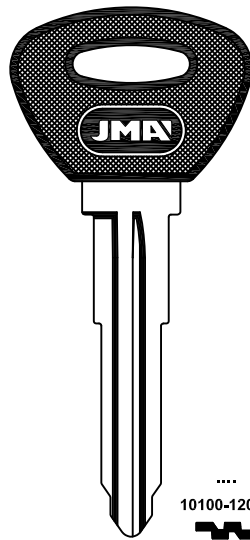

....
10100-12099



MAZ-7D.P1

MAZDA

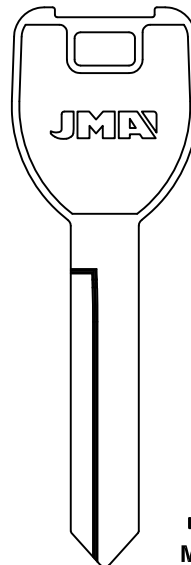

...A...
101-291
501-579
...B...
101-332
501-602
...C...
101-344
501-624
...D...
101-327
501-602
...E...
101-296
501-579



MAZ-8D

MAZDA

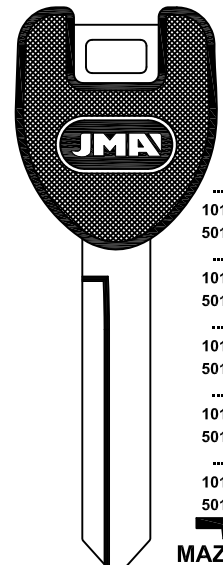

...A...
101-291
501-579
...B...
101-332
501-602
...C...
101-344
501-624
...D...
101-327
501-602
...E...
101-296
501-579



MAZ-8D.P

MAZDA

MAZDA

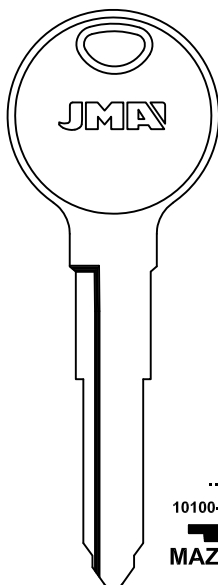

....
10100-12099



MAZ-11D

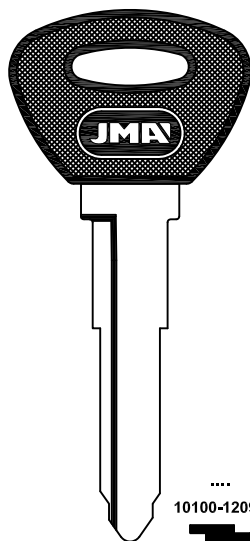

....
10100-12099



MAZ-11D.P1

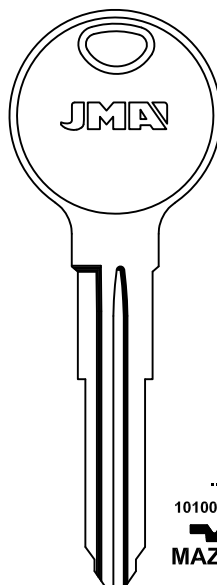

....
10100-12099



MAZ-13D

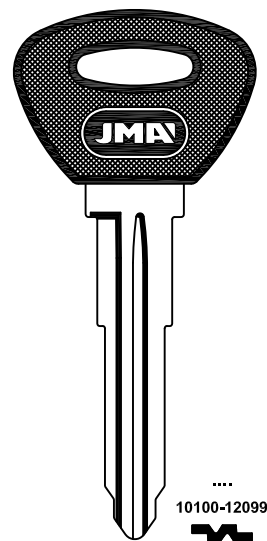

....
10100-12099



MAZ-13D.P



MAZDA

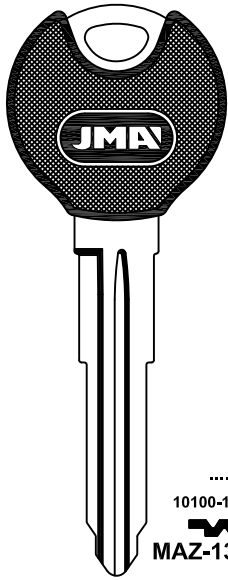

....
10100-12099

MAZ-13D.P1

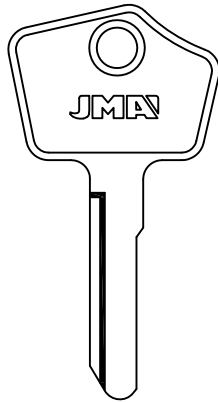

...002-989

MAZ-14D

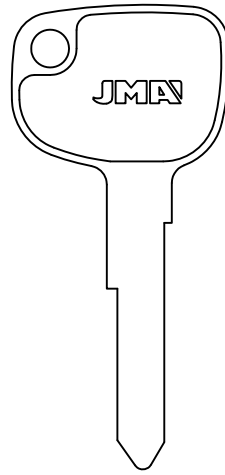

MAZ-15D

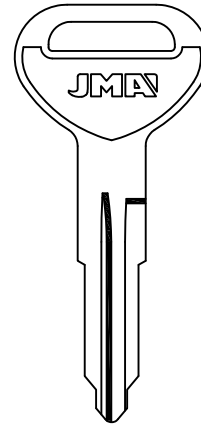

M....
1-3392

MAZ-16

PARA-FOR:

- MAZDA (J)
- MERIT-LINDE (D)
- MISCELLANEOUS
- MITSUBISHI (J)

MAZDA

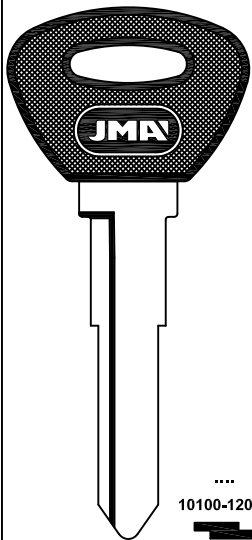

....
10100-12099

MAZ-21D.P1

MERIT-LINDE

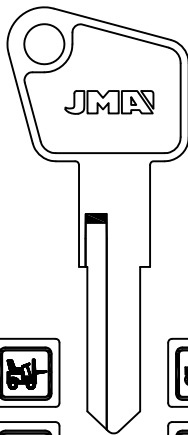

MERI-1D

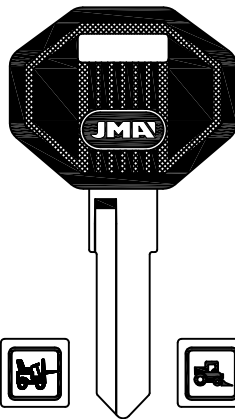

MERI-1D.P

MISCELLANEOUS

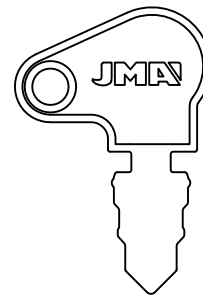

LAT.

MIS-1

MITSUBISHI

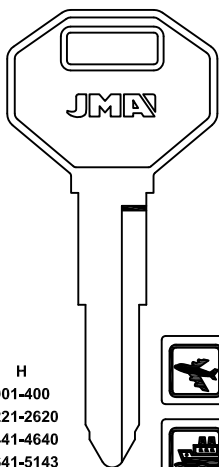

H
001-400
2221-2620
4441-4640
4641-5143
E
2001-3000

MIT-11



MIT-1D

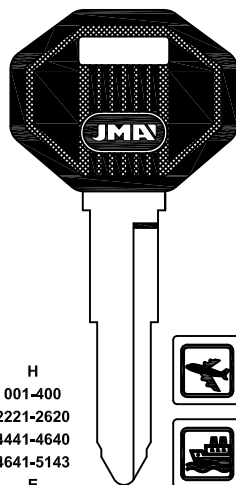

H
001-400
2221-2620
4441-4640
4641-5143
E
2001-3000

MIT-11.P



MIT-1D.P

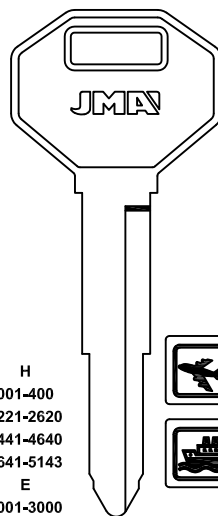

H
001-400
2221-2620
4441-4640
4641-5143
E
2001-3000

MIT-2I



MIT-2D

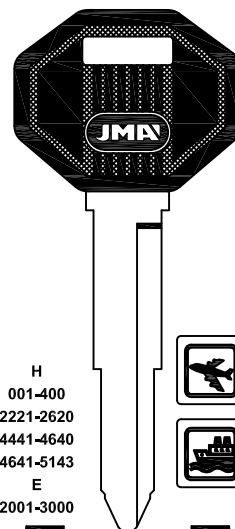

H
001-400
2221-2620
4441-4640
4641-5143
E
2001-3000

MIT-2D.P



MIT-2D.P

CHRYSLER-HOLDEN-HSUZU-MITSUBISHI

CHRYSLER-GM-HYUNDAI-HSUZU
MITSUBISHI-SUZUKI



PARA-FOR:
MITSUBISHI (J)

MITSUBISHI

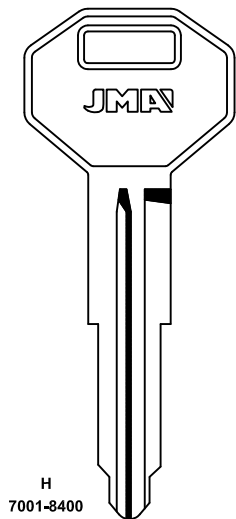

H
7001-8400
MIT-3

MITSUBISHI-OPEL

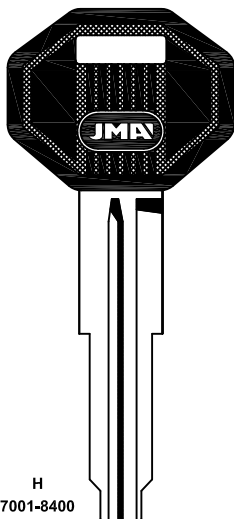

H
7001-8400
MIT-3.P

MITSUBISHI-OPEL

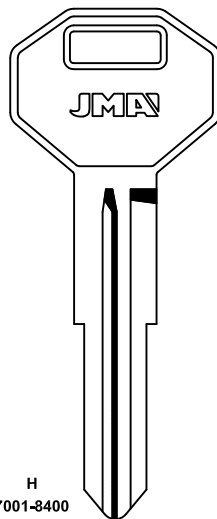

H
7001-8400
MIT-4

MITSUBISHI

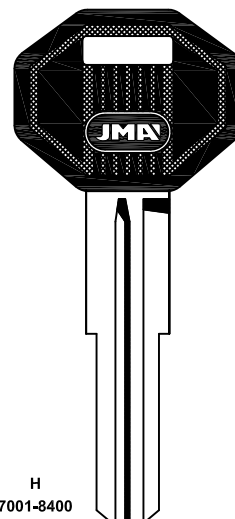

H
7001-8400
MIT-4.P

MITSUBISHI

MITSUBISHI

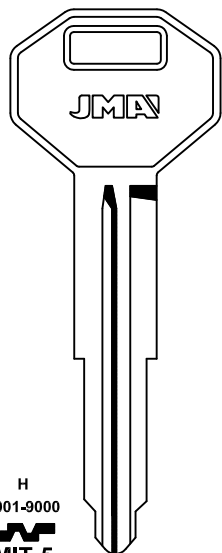

H
7001-9000
MIT-5

MITSUBISHI

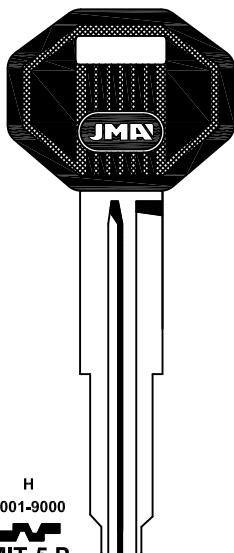

H
7001-9000
MIT-5.P

MITSUBISHI

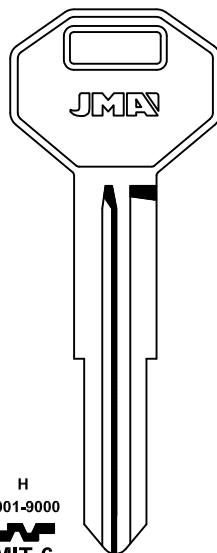

H
7001-9000
MIT-6

MITSUBISHI

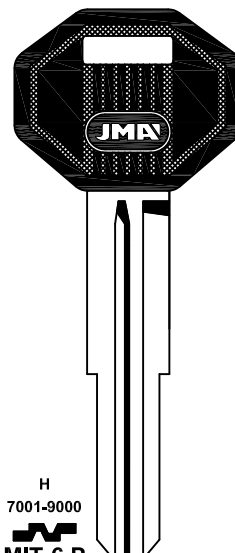

H
7001-9000
MIT-6.P

MITSUBISHI

MITSUBISHI

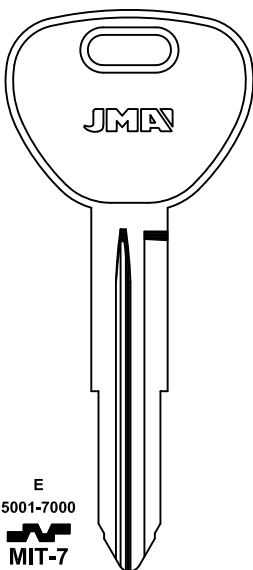

E
5001-7000
MIT-7

BERTONE
CHRYSLER-MITSUBISHI

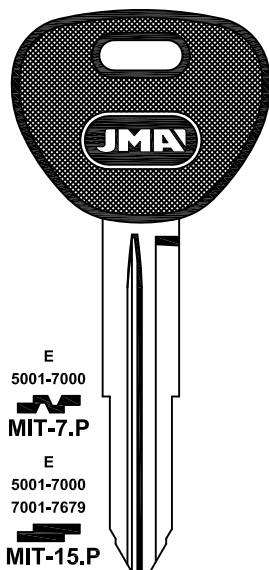

E
5001-7000
MIT-7.P

E
5001-7000
7001-7679
MIT-15.P
BERTONE
CHRYSLER-MITSUBISHI

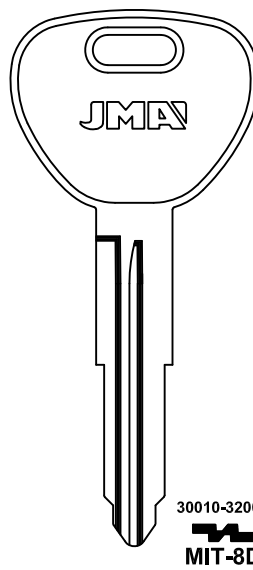

30010-32009
MIT-8D

CHRYSLER-MITSUBISHI

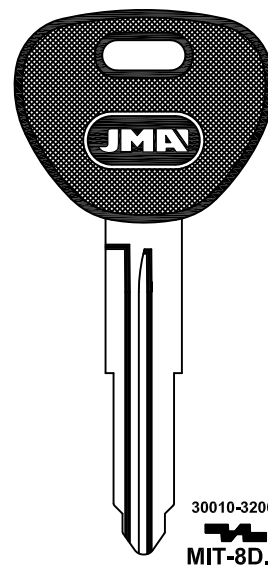

30010-32009
MIT-8D.P

CHRYSLER-MITSUBISHI



MITSUBISHI

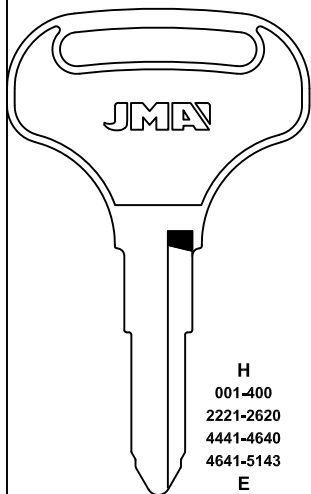

H
001-400
2221-2620
4441-4640
4641-5143
E
2001-3000



MITSUBISHI

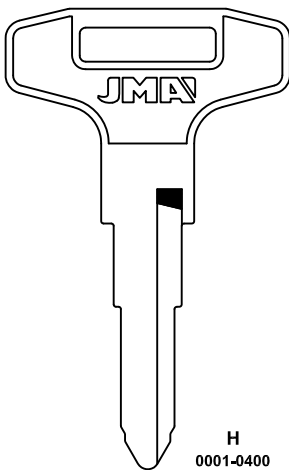

H
0001-0400
2221-2620
4441-5143



MITSUBISHI

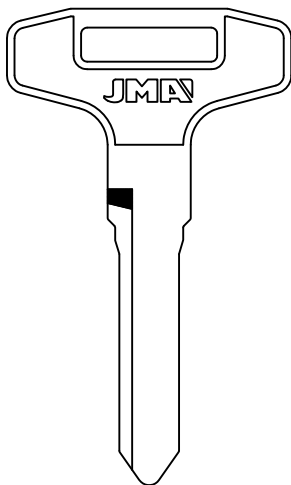

8100-9113



MITSUBISHI

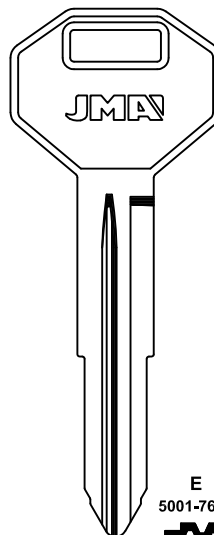

E
5001-7679



BERTONE-CHRYSLER-MITSUBISHI

PARA-FOR:

MITSUBISHI (J)

MONDIAL (F)

MOSKVITCH (RUS)

NEIMAN (F)

MITSUBISHI

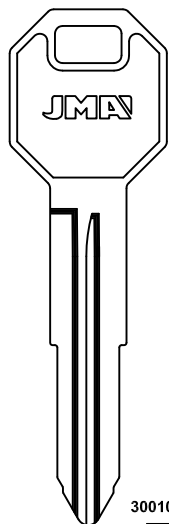

30010-32009



MIT-13D

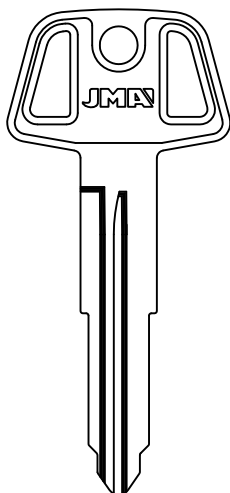

30010-32009



MIT-14D

CHRYSLER-MITSUBISHI

MONDIAL

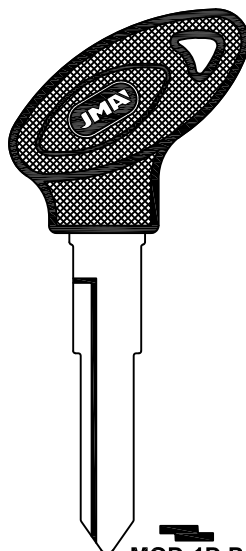

MOD-1D.P

MOSKVITCH

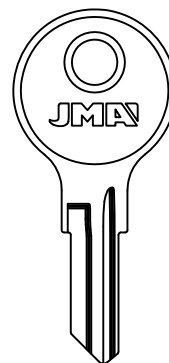

MOS-1

NEIMAN

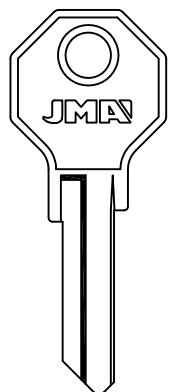

41-4/4

RENAULT

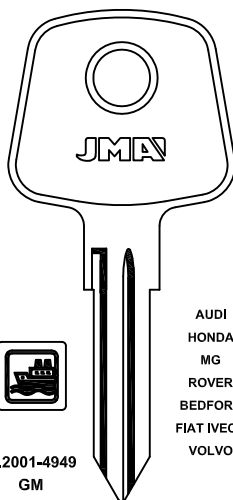

....2001-4949

GM

....2001-3000

NE-1

CLAUSOR

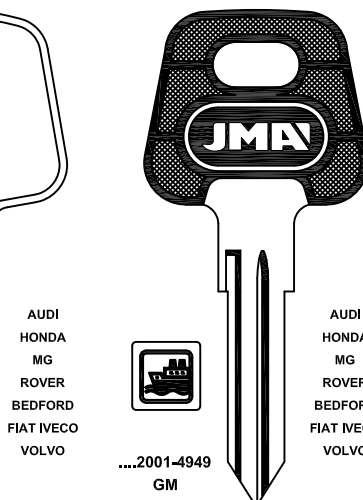

AUDI
HONDA
MG
ROVER
BEDFORD
FIAT IVECO
VOLVO

....2001-4949

GM

....2001-3000

NE-1.P

CLAUSOR

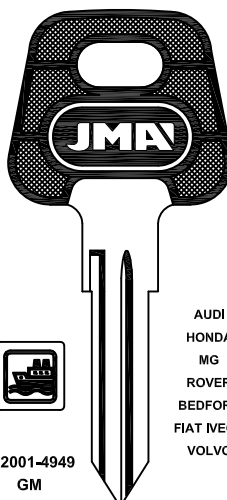

AUDI
HONDA
MG
ROVER
BEDFORD
FIAT IVECO
VOLVO

NE-1D.P

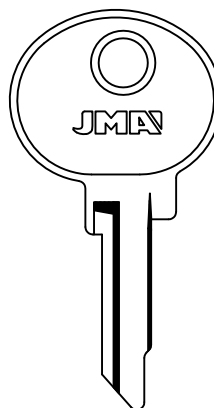

S,T,X,Y

Z,R

1-2-3-5-7

NE-2

CLAUSOR

JMA[®]

Copyright by Alejandro Altuna S.A. 2014



ATENCIÓN: Concerniente a las marcas y denominaciones comerciales ver nota en índice.

ATTENTION: Concerning the marks and commercial denominations see note in index.

ATTENTION: Concernant les marques et dénominations commerciales voir la note dans l'index.

ACHTUNG: Beziehen auf die marke und handelsname sehen sie die notiz im index.

PARA-FOR:
NEIMAN (F)

NEIMAN

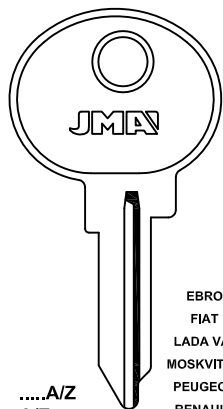

.....A/Z
A/Z.....
A/Z.....A/Z
1 AL 7
.....A/Z
0 AL 9



NE-3

CLAUSOR

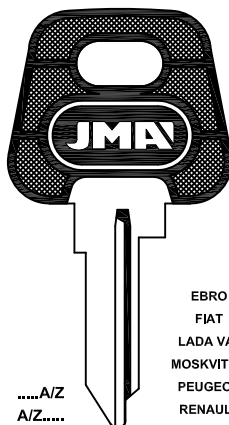

.....A/Z
A/Z.....
A/Z.....A/Z
1 AL 7
.....A/Z
0 AL 9



NE-3.P

CLAUSOR

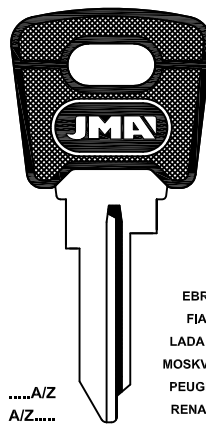

.....A/Z
A/Z.....
A/Z.....A/Z
1 AL 7
.....A/Z
0 AL 9



NE-3.P1

CLAUSOR

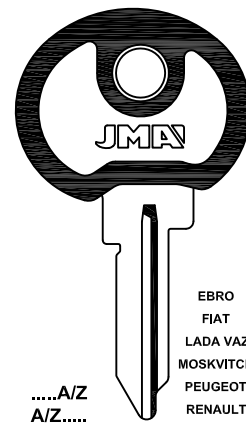

.....A/Z
A/Z.....
A/Z.....A/Z
1 AL 7
.....A/Z
0 AL 9



NE-3.P2

CLAUSOR

NEIMAN

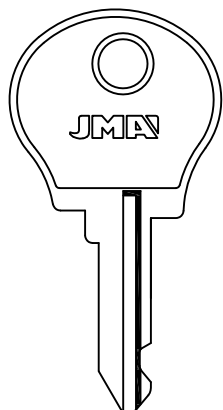

.A/Z.....
.A/Z.....A/Z
A/Z.....A/Z
0 AL 8
1 AL 7
A/Z.....1 AL 7 Y A AL E



NE-4

11-34-39....
1 AL 7
34-39....A/Z
1 AL 7



NE-15I

ACM-ARO DACIA-CITROEN-FIAT-RENAULT
CLAUSOR

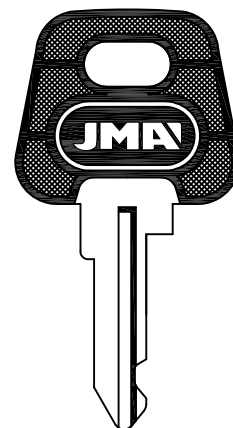

.A/Z.....
.A/Z.....A/Z
A/Z.....A/Z
0 AL 8
1 AL 7
A/Z.....1 AL 7 Y A AL E



NE-4D

11-34-39....
1 AL 7
34-39....A/Z
1 AL 7



NE-15I.P

ACM-ARO DACIA-CITROEN-FIAT-RENAULT
CLAUSOR

NEIMAN

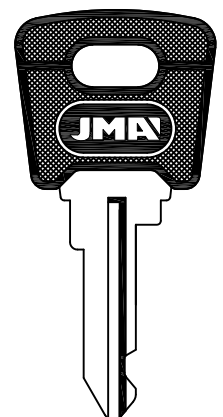

.A/Z.....
.A/Z.....A/Z
A/Z.....A/Z
0 AL 8
1 AL 7
A/Z.....1 AL 7 Y A AL E



NE-4.P1

11-34-39....
1 AL 7
34-39....A/Z
1 AL 7



NE-15I.P1

ACM-ARO DACIA-CITROEN-FIAT-RENAULT
CLAUSOR

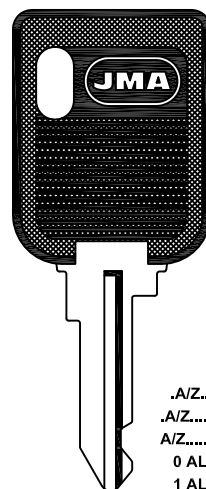

.A/Z.....
.A/Z.....A/Z
A/Z.....A/Z
0 AL 8
1 AL 7
A/Z.....1 AL 7 Y A AL E



NE-4.P2

RENAULT
CLAUSOR

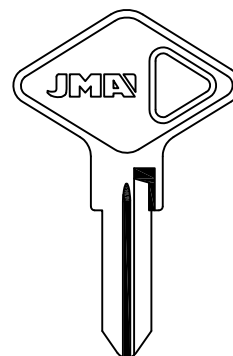

NE-5
CLAUSOR



NEIMAN

PARA-FOR:
NEIMAN (F)

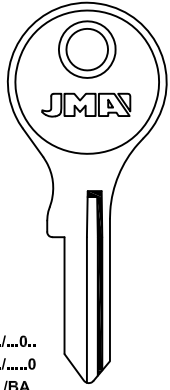

.0.../...0..
....0/....0
AA.../BA...
CA.../EA...
Z.../Z...
..Z.../..Z...
...Z.../...Z...
1 AL 5



NE-6

VARIAS MARCAS DE MOTOS

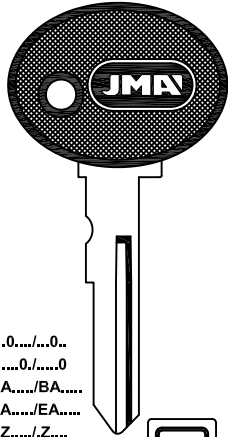

.0.../...0..
....0/....0
AA.../BA...
CA.../EA...
Z.../Z...
..Z.../..Z...
...Z.../...Z...
1 AL 5



NE-6.P

VARIAS MARCAS DE MOTOS

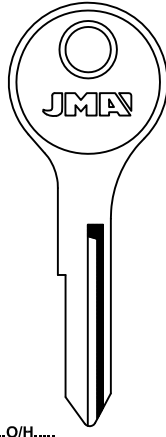

....O/H....
..H.../..H...
...H.../...H...
1 AL 5

NE-7

BMW

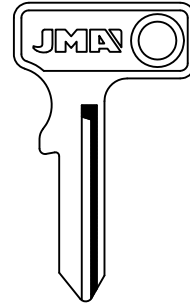

.0.../...0...
....0/0....0
AA.../BA...
CA...
1 AL 5

NE-8

VARIAS MARCAS DE MOTOS
CLAUSOR

NEIMAN

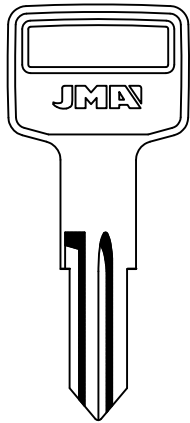

....6250-6499

NE-9

VOLVO
CLAUSOR

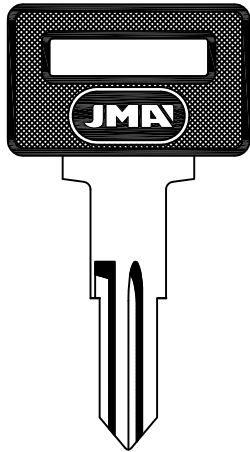

....6250-6499

NE-9.P

VOLVO
CLAUSOR

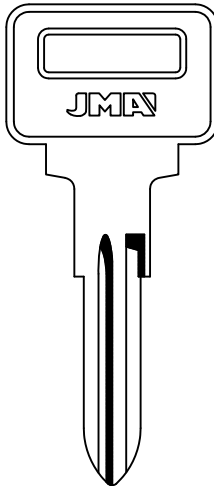

....7001-9000

NE-10

DE LOREAN-MG-VOLVO-BEDFORD

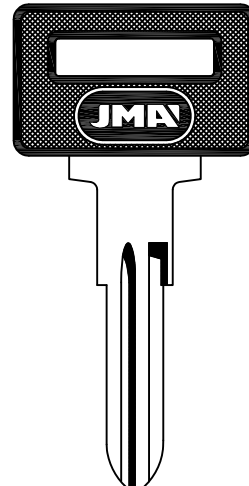

....7001-9000

NE-10.P

DE LOREAN-MG-VOLVO-BEDFORD

NEIMAN

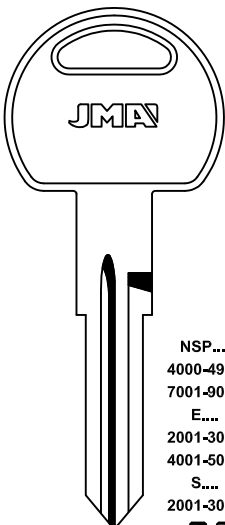

NSP...
4000-4999
7001-9000
E...
2001-3000
4001-5000
S...
2001-3000

NE-11

FORD-NISSAN-ROVER-STERLING
DAF-KENWORTH

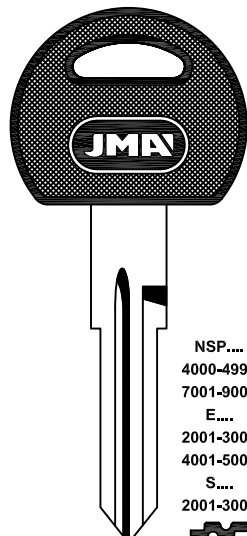

NSP...
4000-4999
7001-9000
E...
2001-3000
4001-5000
S...
2001-3000

NE-11.P

FORD-NISSAN-ROVER-STERLING
DAF-KENWORTH

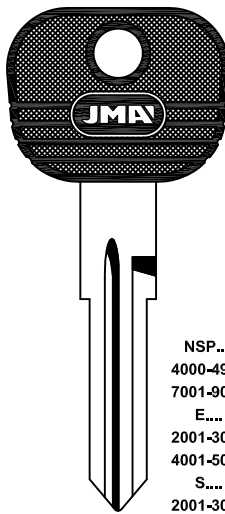

NSP...
4000-4999
7001-9000
E...
2001-3000
4001-5000
S...
2001-3000

NE-11.P1

LAND RANGE ROVER-ROVER

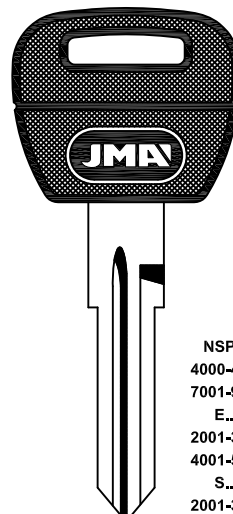

NSP...
4000-4999
7001-9000
E...
2001-3000
4001-5000
S...
2001-3000

NE-11.P2

ROVER

JMA[®]

Copyright by Alejandro Altuna S.A. 2014



ATENCIÓN: Concerniente a las marcas y denominaciones comerciales ver nota en índice.
ATTENTION: Concerning the marks and commercial denominations see note in index.
ATTENTION: Concernant les marques et dénominations commerciales voir la note dans l'index.
ACHTUNG: Beziehen auf die marke und handelsname sehen sie die notiz im index.

PARA-FOR:
NEIMAN (F)

NEIMAN

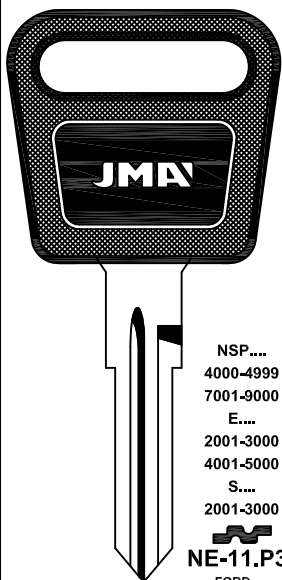

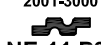
NSP....
4000-4999
7001-9000
E....
2001-3000
4001-5000
S....
2001-3000

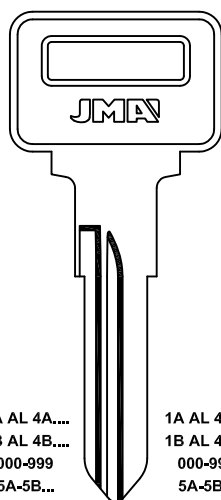
NE-11.P3
FORD

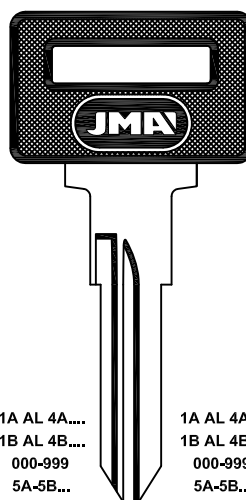

1A AL 4A....
1B AL 4B....
000-999
5A-5B...
000-746

NE-12
VOLVO

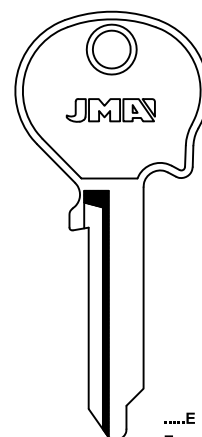



1A AL 4A....
1B AL 4B....
000-999
5A-5B...
000-746

NE-12.P
VOLVO



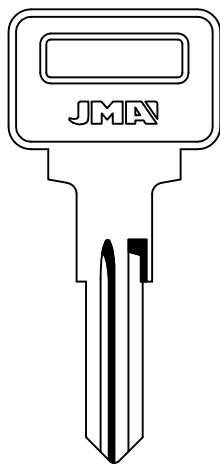

....E
E....
N....
X....
1 AL 5

NE-13
VOLVO

NEIMAN

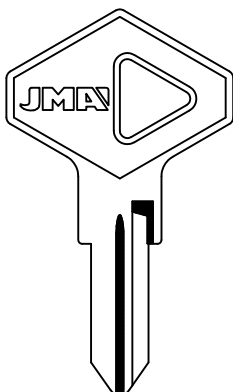

NP....
1-1000

NE-14
ROVER
CEM

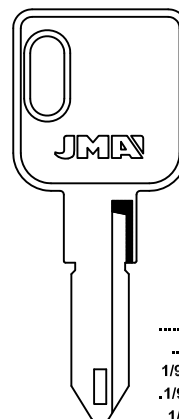

T...001-999
V...000-922
2.....
2.....A/Z
B-C-D-E-G

NE-16
AMERICAN MOTORS-RENAULT
CLAUSOR

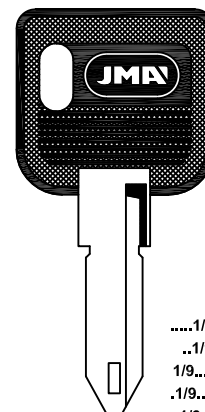

....1/9..A/Z
..1/9....
1/9.....A/Z
.1/9.....A/Z
..1/9.....A/Z
...1/9...A/Z
....1/9..A/Z
.....1/9..A/Z
M-N-P-R-S

NE-19
AMERICAN MOTORS-CHRYSLER-PEUGEOT
RENAULT



....1/9..A/Z
..1/9....
1/9.....A/Z
.1/9.....A/Z
..1/9.....A/Z
...1/9...A/Z
....1/9..A/Z
.....1/9..A/Z
M-N-P-R-S

NE-19.P
RENAULT

NEIMAN

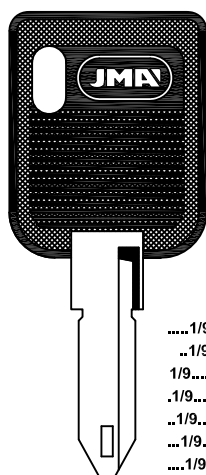

....1/9..A/Z
..1/9....
1/9.....A/Z
.1/9.....A/Z
..1/9.....A/Z
...1/9...A/Z
....1/9..A/Z
.....1/9..A/Z
M-N-P-R-S

NE-19.P1
RENAULT

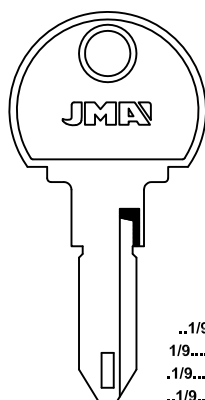

..1/9....
1/9.....A/Z
.1/9.....A/Z
..1/9.....A/Z
...1/9...A/Z
....1/9..A/Z
.....1/9..A/Z
M-N-P-R-S

NE-20
PEUGEOT

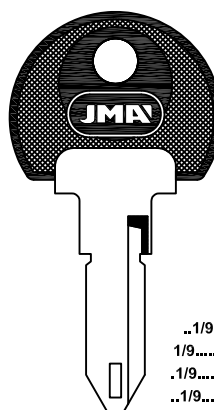

..1/9....
1/9.....A/Z
.1/9.....A/Z
..1/9.....A/Z
...1/9...A/Z
....1/9..A/Z
.....1/9..A/Z
M-N-P-R-S

NE-20.P
PEUGEOT

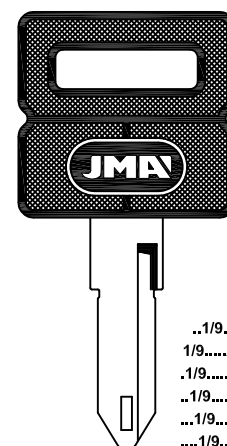

..1/9....
1/9.....A/Z
.1/9.....A/Z
..1/9.....A/Z
...1/9...A/Z
....1/9..A/Z
.....1/9..A/Z
M-N-P-R-S

NE-20.P1
PEUGEOT



NEIMAN

PARA-FOR:
NEIMAN (F)

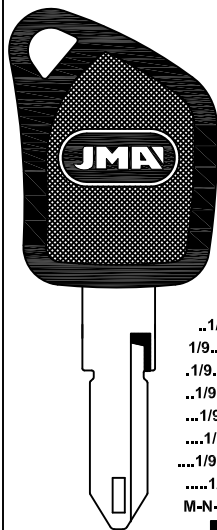

..1/9....
1/9.....A/Z
.1/9.....A/Z
..1/9.....A/Z
...1/9...A/Z
....1/9..A/Z
.....1/9..A/Z
M-N-P-R-S

NE-20.P2

PEUGEOT

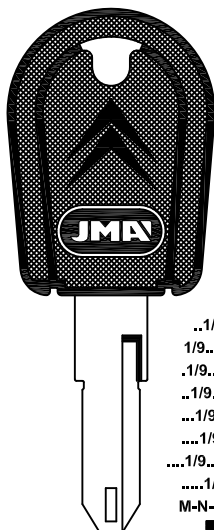

..1/9....
1/9.....A/Z
.1/9.....A/Z
..1/9.....A/Z
...1/9...A/Z
....1/9..A/Z
.....1/9..A/Z
M-N-P-R-S

NE-20.P3

CITROEN

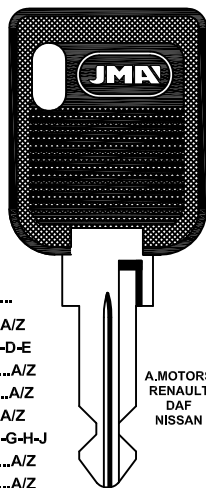

.....
.....A/Z
B-C-D-E
1/9.....A/Z
1/9.....A/Z
.....A/Z
B-D-E-G-H-J
.1/9.....A/Z
.1/9.....A/Z
E-M-N-P-R

NE-22.P

CLAUSOR

A.MOTORS
RENAULT
DAF
NISSAN

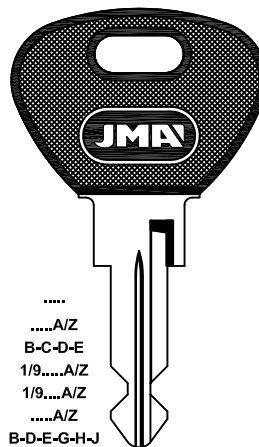

.....
.....A/Z
B-C-D-E
1/9.....A/Z
1/9.....A/Z
.....A/Z
B-D-E-G-H-J
.1/9.....A/Z
.1/9.....A/Z
E-M-N-P-R

NE-22.P1

CITROEN-PEUGEOT-PEGASO

CLAUSOR

NEIMAN

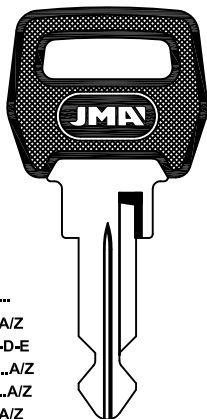

.....
.....A/Z
B-C-D-E
1/9.....A/Z
1/9.....A/Z
.....A/Z
B-D-E-G-H-J
.1/9.....A/Z
.1/9.....A/Z
E-M-N-P-R

NE-22.P2

MAZDA-TALBOT SIMCA-DAF

CLAUSOR

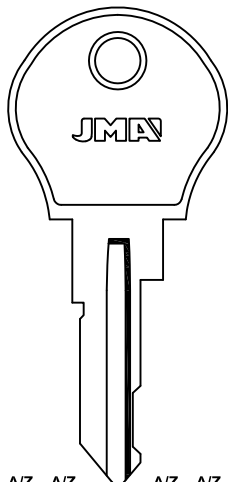

A/Z.....A/Z
0-4-6-8-9

NE-23

MAZDA
DATSUN

A/Z.....A/Z
0-4-6-8-9

NE-26

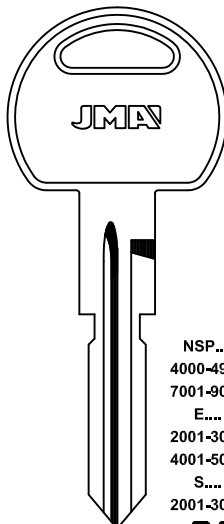

NSP....
4000-4999
7001-9000
E....
2001-3000
4001-5000
S....
2001-3000

NE-24

FORD-ROVER-STERLING

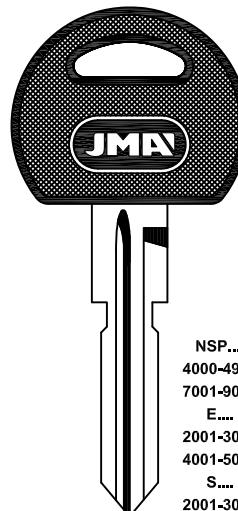

NSP....
4000-4999
7001-9000
E....
2001-3000
4001-5000
S....
2001-3000

NE-24.P

FORD-ROVER-STERLING

NEIMAN

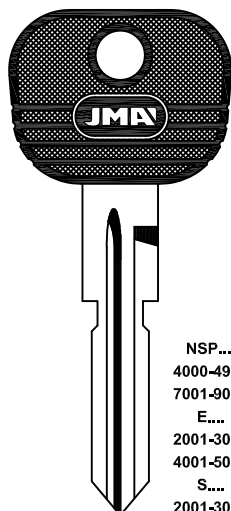

NSP....
4000-4999
7001-9000
E....
2001-3000
4001-5000
S....
2001-3000

NE-24.P1

LAND RANGE ROVER-ROVER

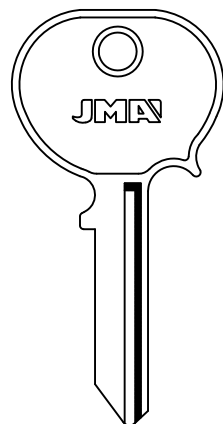

.....A
.....D
.....F
1 AL 5

NE-25

ALFA ROMEO-FERRARI-STEYR PUCH

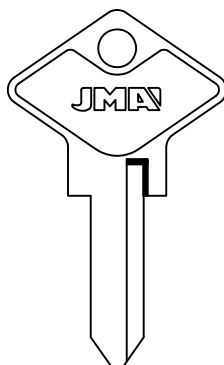

NE-27

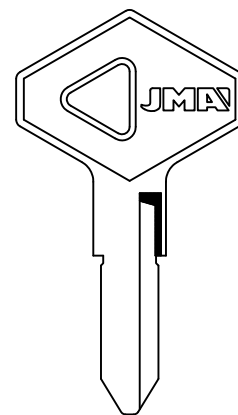

..1/9....A/Z
M-N-P-R-S

NE-28

CHRYSLER (EAGLE)-RENAULT



PARA-FOR:
NEIMAN (F)

NEIMAN

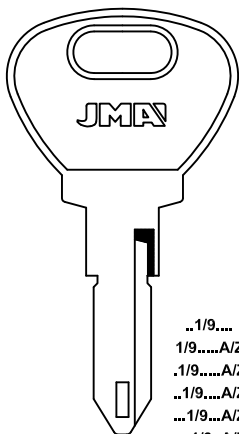

..1/9....
1/9....A/Z
.1/9....A/Z
..1/9....A/Z
...1/9....A/Z
....1/9..A/Z
....1/9..A/Z A/Z
.....1/9.A/Z
.....1/9.A/Z
M-N-P-R-S
 NE-29

PEUGEOT

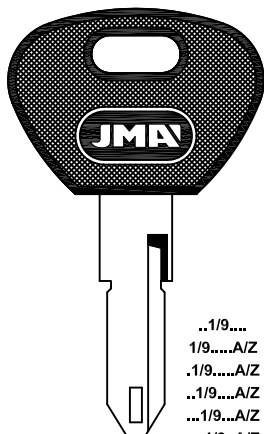

..1/9....
1/9....A/Z
.1/9....A/Z
..1/9....A/Z
...1/9....A/Z
....1/9..A/Z
....1/9..A/Z A/Z
.....1/9.A/Z
.....1/9.A/Z
M-N-P-R-S
 NE-29.P

PEUGEOT

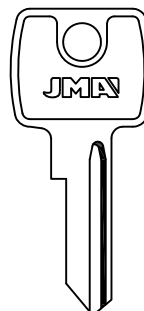

....
5001-6278

NE-30

BASTA

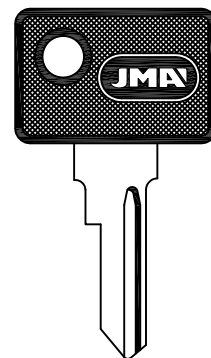

....
5001-6278

NE-30.P

BASTA

NEIMAN

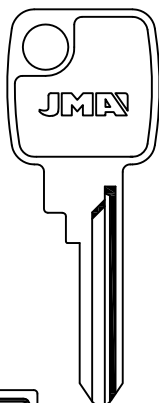

..1/9....A/Z
M-N-P-R-S

NE-31

BASTA

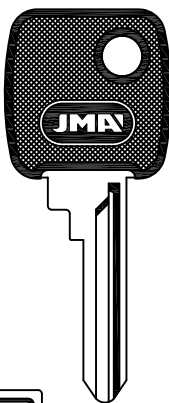

..1/9....A/Z
M-N-P-R-S

NE-31.P

BASTA

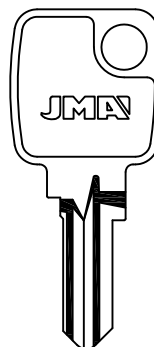

.B...3-5-7-L
..B...3-5-7-L/2-3-5-7-L
...B...3-5-7-L
....B...3-5-7-L

NE-32

BASTA



.B...3-5-7-L
..B...3-5-7-L/2-3-5-7-L
...B...3-5-7-L
....B...3-5-7-L

NE-32.P

BASTA

NEIMAN

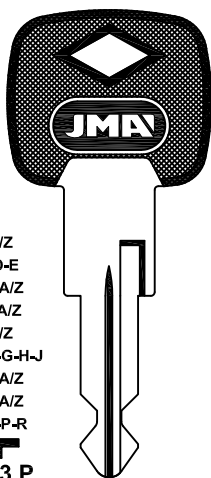

.....
....A/Z
B-C-D-E
1/9....A/Z
1/9....A/Z
....A/Z
B-D-E-G-H-J
.1/9....A/Z
.1/9....A/Z
E-M-N-P-R
 NE-33.P

NE-44.P

RENAULT
CLAUSOR

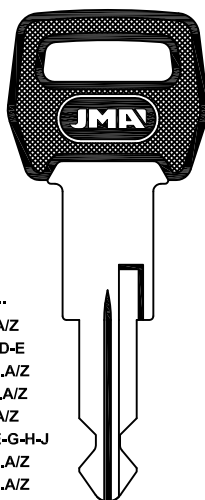

.....
....A/Z
B-C-D-E
1/9....A/Z
1/9....A/Z
....A/Z
B-D-E-G-H-J
.1/9....A/Z
.1/9....A/Z
E-M-N-P-R
 NE-33.P1

NE-33.P1

TALBOT SIMCA
CLAUSOR



LAT.

NA/Z.....
0 AL 9
A AL F

NE-34.P

PEUGEOT

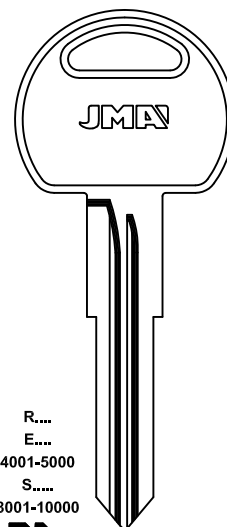

R...
E...
4001-5000
S.....
8001-10000

NE-35

HONDA-ROVER



NEIMAN

PARA-FOR:
NEIMAN (F)

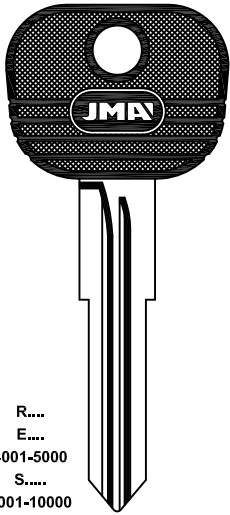

R....
E....
4001-5000
S....
8001-10000

NE-35.P

ROVER

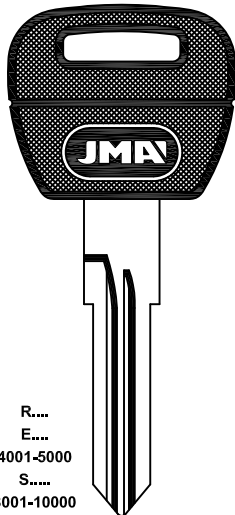

R....
E....
4001-5000
S....
8001-10000

NE-35.P2

HONDA-ROVER

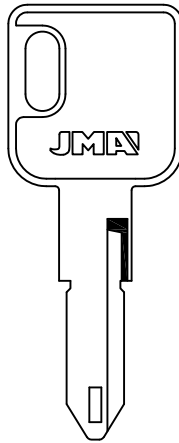

..1/9....
1/9....A/Z
.1/9....A/Z
..1/9....A/Z
...1/9....A/Z
....1/9....A/Z
.....1/9..A/Z
M-N-P-R-S

NE-36

CITROEN-PEUGEOT-RENAULT

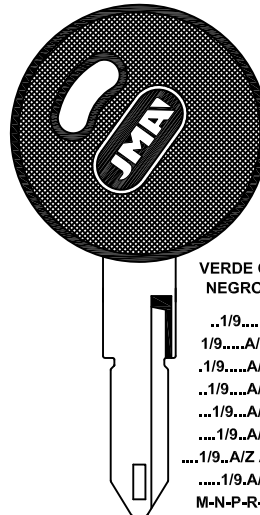

VERDE O
NEGRO

..1/9....
1/9....A/Z
.1/9....A/Z
..1/9....A/Z
...1/9....A/Z
....1/9....A/Z
.....1/9..A/Z
M-N-P-R-S

NE-36.P

RENAULT

NEIMAN

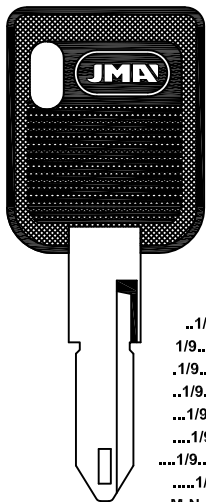

..1/9....
1/9....A/Z
.1/9....A/Z
..1/9....A/Z
...1/9....A/Z
....1/9..A/Z
.....1/9..A/Z A/Z
M-N-P-R-S

NE-36.P1

CITROEN-PEUGEOT-RENAULT

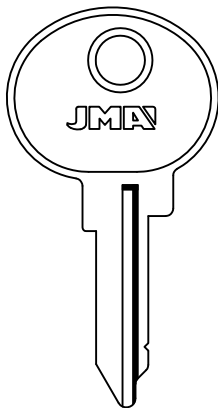

....A/Z
1-2-3-5-7

NE-37

PEUGEOT

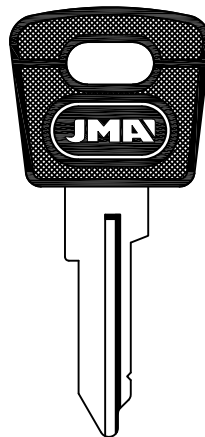

....A/Z
1-2-3-5-7

NE-37.P

PEUGEOT

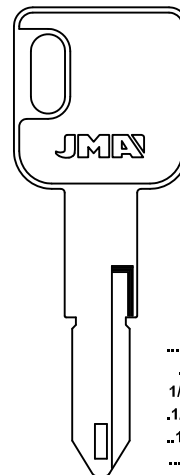

.....1/9..A/Z
..1/9....
1/9....A/Z
.1/9....A/Z
..1/9....A/Z
...1/9....A/Z
....1/9..A/Z
.....1/9..A/Z A/Z

NE-38

RENAULT

NEIMAN

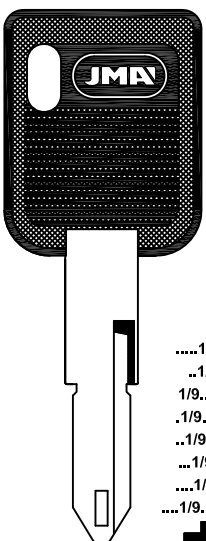

.....1/9..A/Z
..1/9....
1/9....A/Z
.1/9....A/Z
..1/9....A/Z
...1/9....A/Z
....1/9..A/Z
.....1/9..A/Z A/Z

NE-38.P1

RENAULT

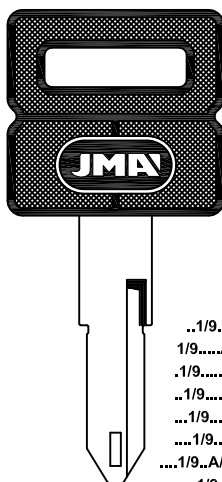

..1/9....
1/9....A/Z
.1/9....A/Z
..1/9....A/Z
...1/9....A/Z
....1/9..A/Z
.....1/9..A/Z A/Z
M-N-P-R-S

NE-39.P

PEUGEOT

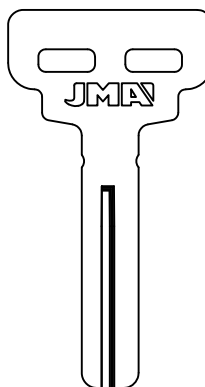

LAT.

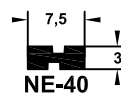

NE-40

VOLVO
YMOS

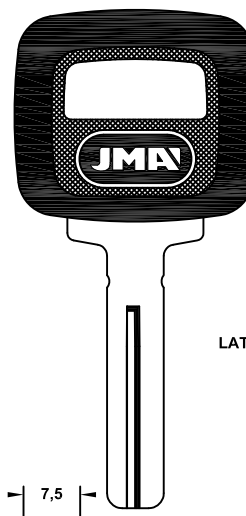

LAT.

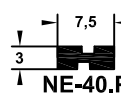

NE-40.P

VOLVO
YMOS



PARA-FOR:
NEIMAN (F-RA)

NEIMAN

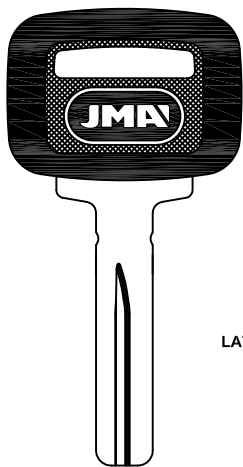

7,5
3
NE-41.P
VOLVO
YMOS

LAT.

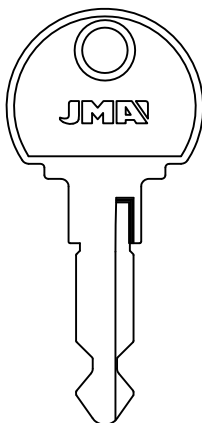

NE-42
PEUGEOT

NEIMAN (RA)

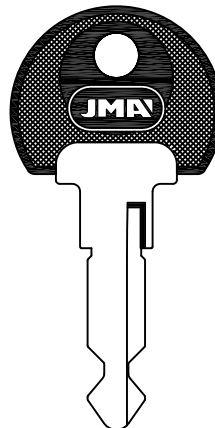

NE-42.P
PEUGEOT

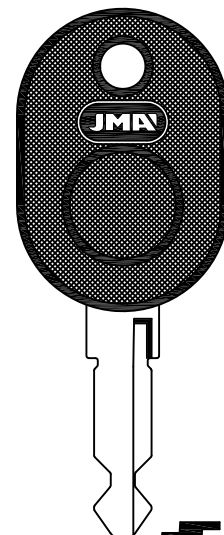

NE-42.P1
PEUGEOT

NEIMAN (RA)

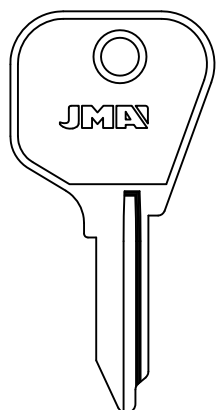

NE-43
PEUGEOT

NEIMAN

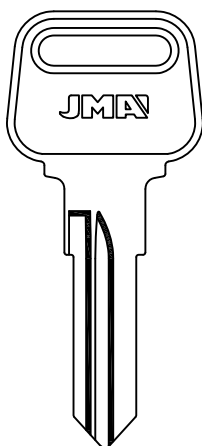

NE-45
PEUGEOT

NEIMAN (RA)

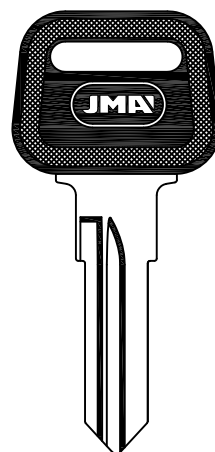

NE-45.P
PEUGEOT

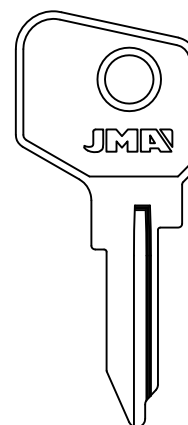

NE-46
FIAT

NEIMAN (RA)

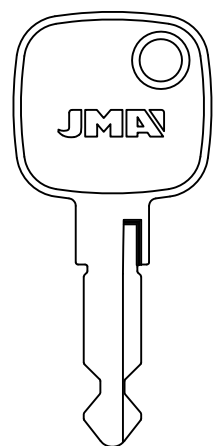

NE-47
FIAT

NEIMAN

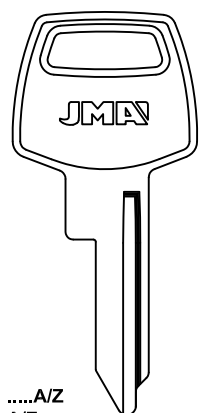

.....A/Z
A/Z.....
A/Z.....A/Z
1 AL 7
.....A/Z
0 AL 9
NE-48

CLAUSOR

NEIMAN (RA)

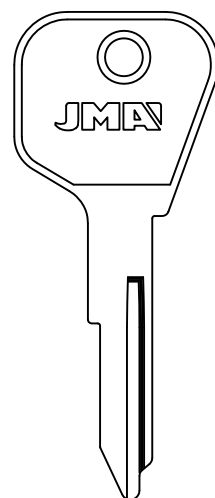

NE-49

NEIMAN

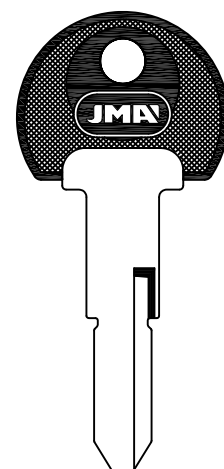

M,N,P,R,S
1/9...A/Z
NE-50.P



NEIMAN

NEIMAN (RA)

PARA-FOR:
NEIMAN (F-RA)

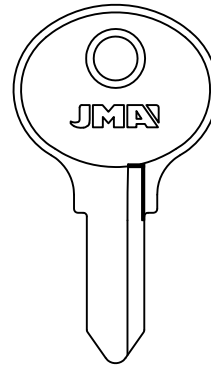
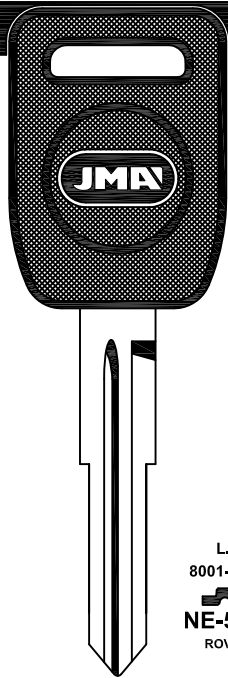
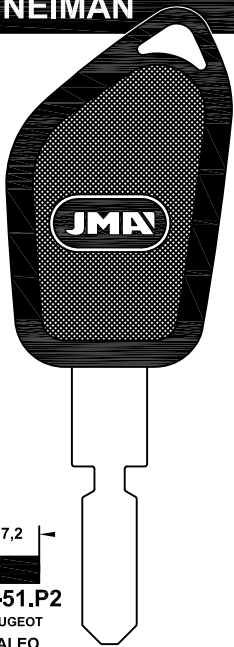

ALP.

3,5 7,2
NE-51.P2
PEUGEOT
VALEO

L.....
8001-10000
NE-52.P
ROVER

NE-53

NEIMAN (RA)

NEIMAN

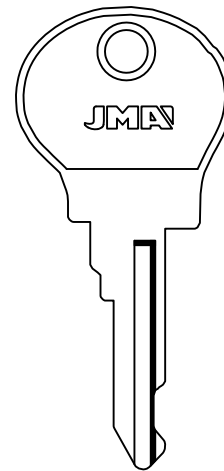
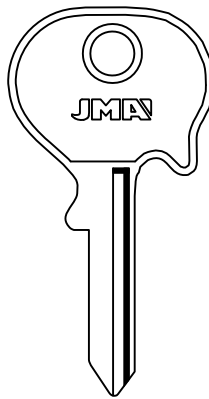
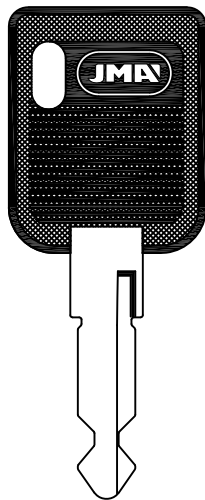
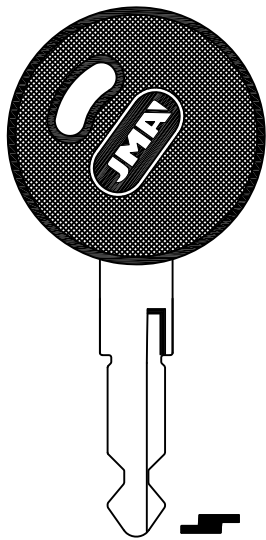

NE-54.P
RENAULT

NE-55.P
RENAULT

.....
1 AL 5
NE-56

NE-57
MAZDA

NEIMAN

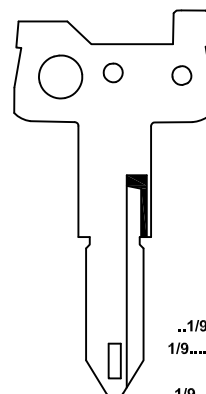
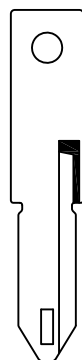
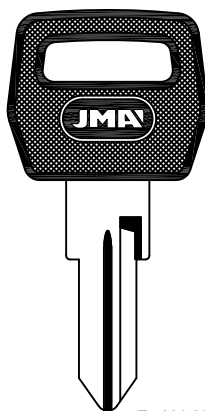
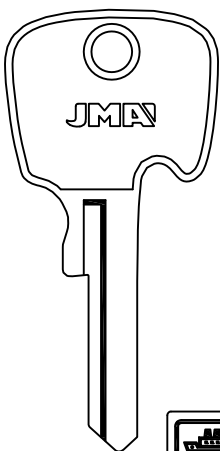

N.....1 AL 5
NE-58D

T...001-999
V...000-922
2.....
2.....A/Z
B-C-D-E-G
NE-59.P

..1/9....
1/9....A/Z
.1/9....A/Z
..1/9....A/Z
...1/9....A/Z
....1/9..A/Z
.....1/9..A/Z A/Z
.....1/9.A/Z
M-N-P-R-S
NE-60C1

..1/9....
1/9....A/Z
..1/9....A/Z
...1/9....A/Z
....1/9..A/Z
.....1/9..A/Z A/Z
.....1/9.A/Z
M-N-P-R-S
NE-60C2

BOMORO-BOSCH

CLAUSOR



PARA-FOR:

NEIMAN (F)

NISSAN (J)

NEIMAN

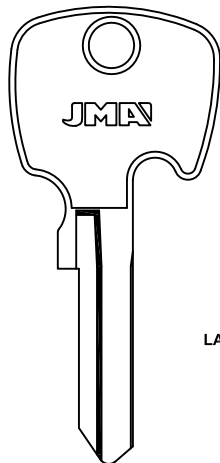

LAT.

D...
1-2-3-4-5

NE-61D

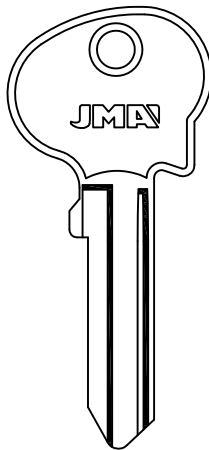

LAT.

8...
1-2-3-4-5

NE-62

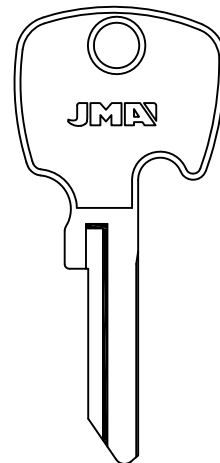

M...
1-2-3-4-5

NE-63D

NISSAN

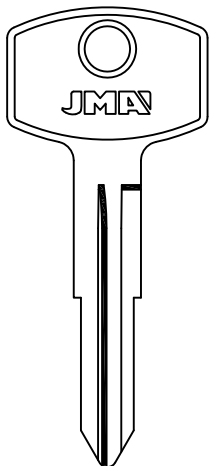

F
0001-1000
1001-2000
M
4001-5000

DAT-1I

M
0001-1000
5001-6000
N
1001-2000

DAT-1D

M
6001-7000
W
0001-1000

DAT-2I

M
7001-8000

DAT-2D

NISSAN-SUBARU
DATSUN-WASO

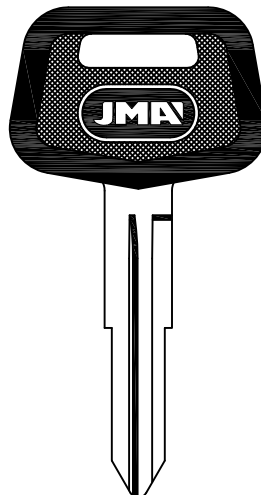

F
0001-1000
1001-2000
M
4001-5000

DAT-1I.P

M
0001-1000
5001-6000
N
1001-2000

DAT-1D.P

M
6001-7000
W
0001-1000

DAT-2I.P

M
7001-8000

DAT-2D.P

NISSAN-SUBARU
DATSUN-WASO

NISSAN

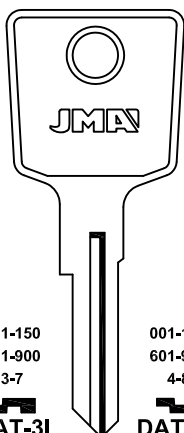

001-150
601-900
3-7

DAT-3I

001-150
601-900
4-8

DAT-3D

001-150
601-900
1-5

DAT-4I

001-150
601-900
6-9

DAT-4D

MAZDA-NISSAN-SUBARU
DATSUN

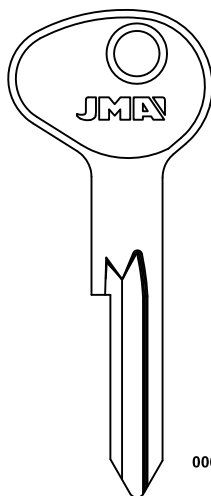

VH
0001-3948
K
00001-14000

DAT-5D

NISSAN
DATSUN-WASO

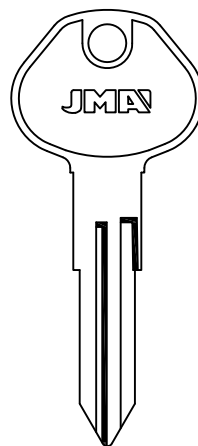

X
0001-8000

DAT-6

DAT-6D

Y
0001-8000
8001-9000

DAT-7

ALFA ROMEO-DELTA-EBRO-GMC-INFINITI-NISSAN-SUBARU
DATSUN



NISSAN

PARA-FOR:
NISSAN (J)



X....1-9000

DAT-6C1

VALEO

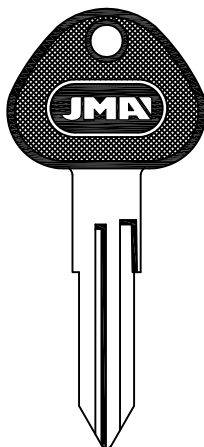

X
0001-8000

DAT-6.P

DAT-6D.P

Y
0001-8000
8001-9000

DAT-7.P

ALFA ROMEO-DELTA-EBRO-GMC-INFINITI-NISSAN-SUBARU
DATSUN

NISSAN



X
0001-8000

DAT-6.P1

DAT-6D.P1

Y
0001-8000
8001-9000

DAT-7.P1

INFINITI-NISSAN-SUBARU
DATSUN

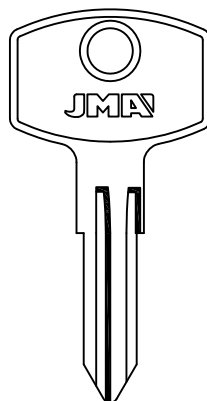

F
0001-1000
1001-2000
M
4001-5000

DAT-8I

M
0001-1000
5001-6000
N
1001-2000

DAT-8

M
6001-7000
7001-800
W
0001-1000

DAT-9I

M
7001-800

DAT-9D

NISSAN-SUBARU
DATSUN

NISSAN

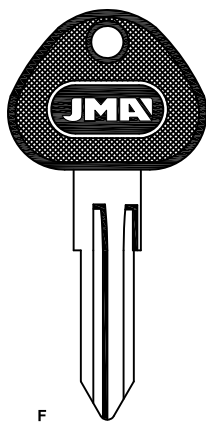

F
0001-1000
1001-2000
M
4001-5000

DAT-8I.P1

NISSAN-SUBARU
DATSUN

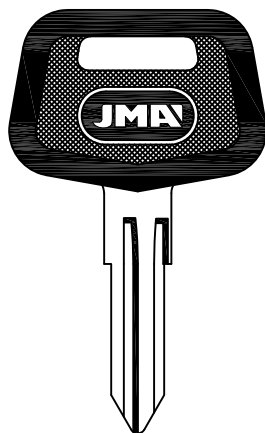

F
0001-1000
1001-2000
M
4001-5000

DAT-8I.P

M
0001-1000
5001-6000
N
1001-2000

DAT-8.P

M
6001-7000
7001-800
W
0001-1000

DAT-9I.P

M
7001-800

DAT-9D.P

NISSAN-SUBARU
DATSUN

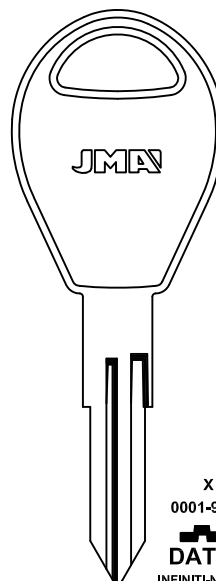

X
0001-9000

DAT-10

INFINITI-NISSAN



PARA-FOR:

NISSAN (J)

NISSAN

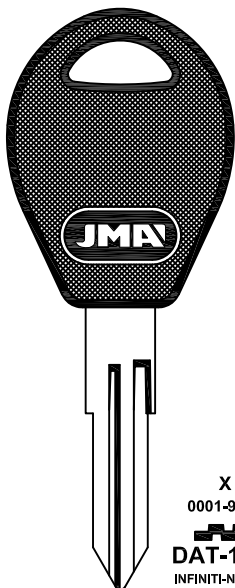

X
0001-9000

DAT-10.P
INFINITI-NISSAN

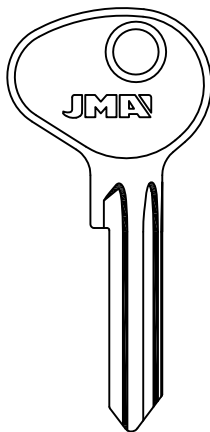

VH
0001-3948
K
00001-14000

DAT-11 DAT-11D
MAZDA-SUBARU
DATSUN-WASO

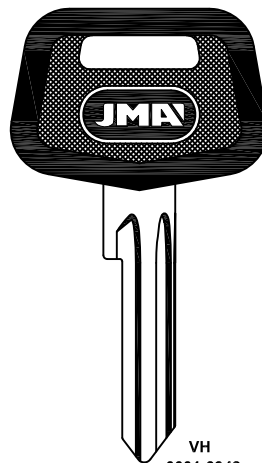

VH
0001-3948
K
00001-14000

DAT-11.P DAT-11D.P
MAZDA-SUBARU
DATSUN-WASO

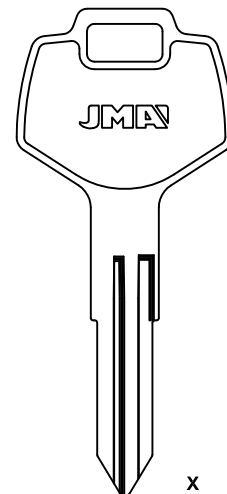

X
0001-9000

DAT-12
HOLDEN-NISSAN

NISSAN

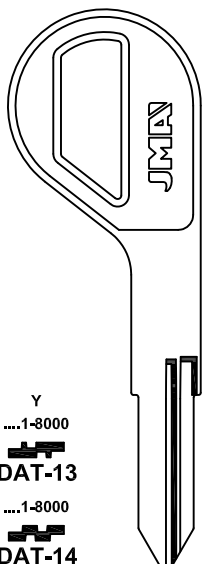

Y
....1-8000

DAT-13

....1-8000

DAT-14

INFINITI

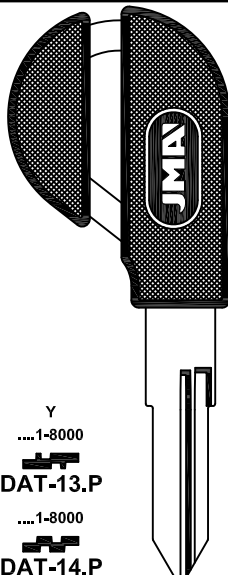

Y
....1-8000

DAT-13.P

....1-8000

DAT-14.P

INFINITI

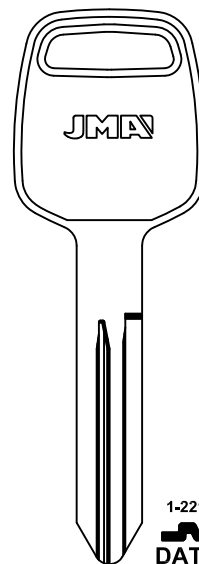

1-22185

DAT-15



....1-22185

DAT-15C1

VALEO

NISSAN

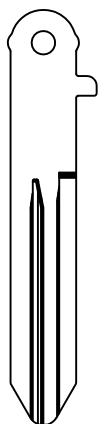

....1-22185

DAT-15C2

VALEO

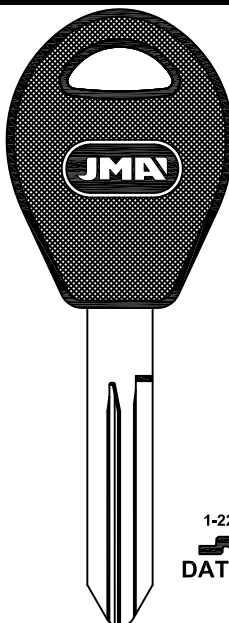

1-22185

DAT-15.P

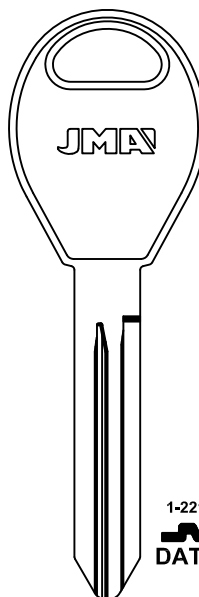

1-22185

DAT-16

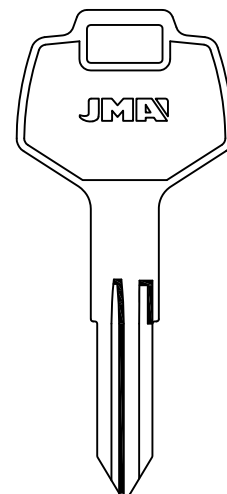

DAT-17

DAT-17D



NISSAN

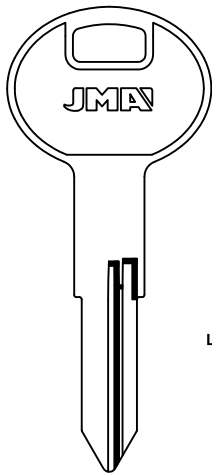

DAT-18

LAT.

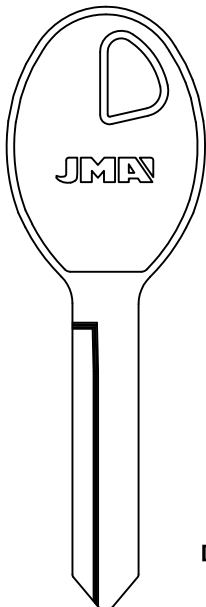

A
101-291
501-579
B
101-332
501-602
C
101-344
501-624
D
101-327
501-602
E
101-296
501-579
DAT-19

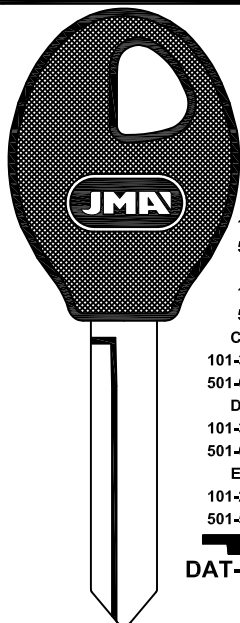

A
101-291
501-579
B
101-332
501-602
C
101-344
501-624
D
101-327
501-602
E
101-296
501-579
DAT-19.P

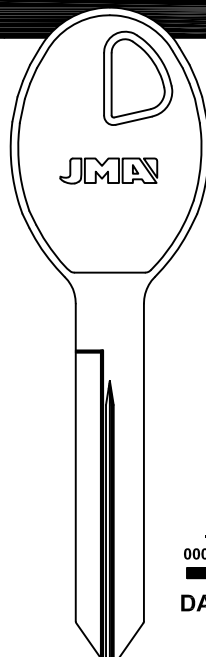

....X
0001-1706
DAT-20

PARA-FOR:

NISSAN (J)

PGO (J)

PJ (F)

NISSAN

PGO

PJ

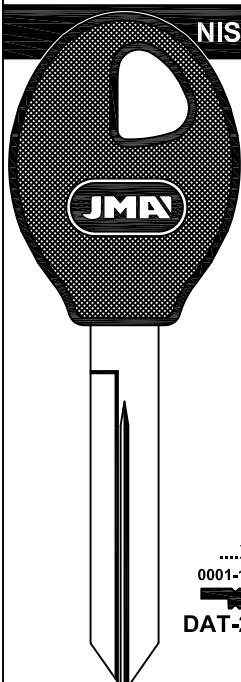

....X
0001-1706
DAT-20.P

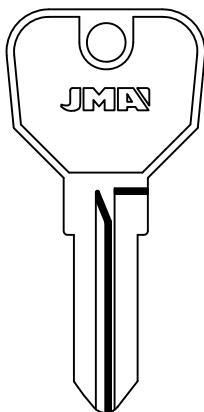

PGO-1

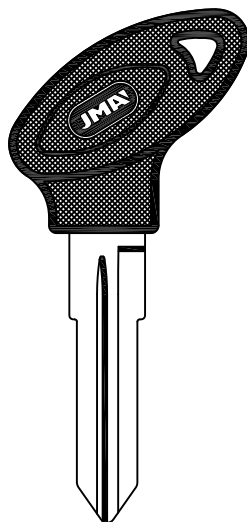

PGO-2.P

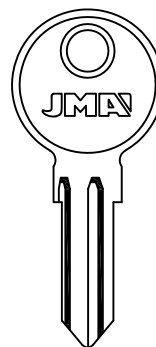

J...
001-224

PJ-1

DAF-RENAULT-TALBOT S.-VOLKSWAGEN
KIFERM

PJ

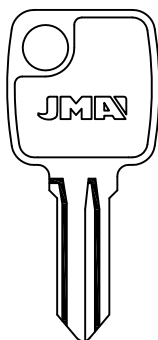

J...
001-224

PJ-2

KIFERM

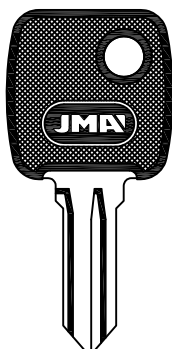

J...
001-224

PJ-2.P

KIFERM

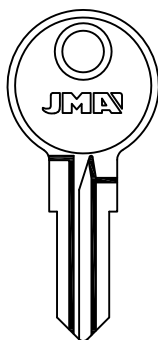

K....4-6-8
K....4-6-8-A-B-C
G..01-99

PJ-3

TALBOT SIMCA

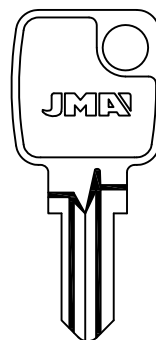











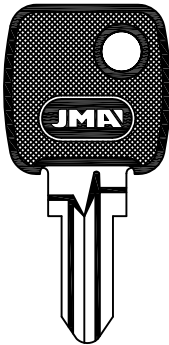

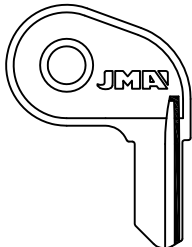

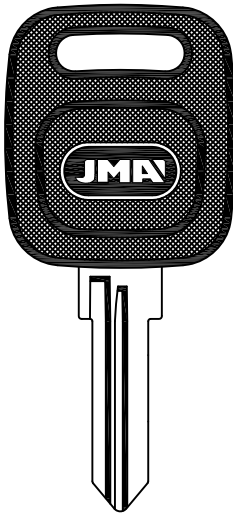

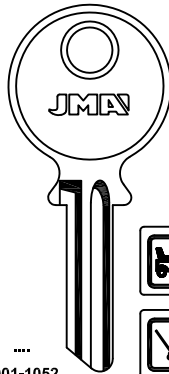



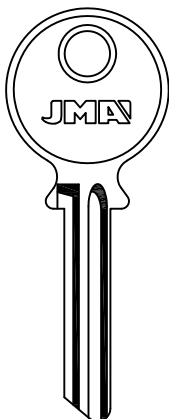







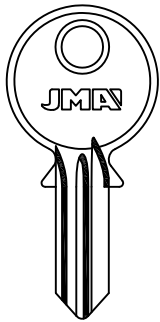
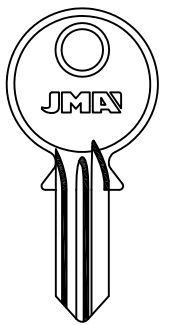

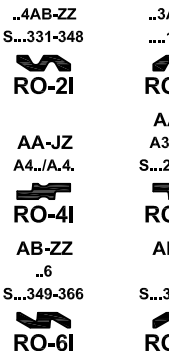







K....4-6-8
K....4-6-8-A-B-C

PJ-K



PARA-FOR:

- PJ (F)
- POLLAK (USA)
- POS (D)
- PRESTA (D)
- RONIS (F)

PJ	POLLAK	POS	PRESTA
  K....4-6-8 K....4-6-8-A-B-C  PJ-K.P	  PLL-1 ERINRUDE	  POS-1D.P SISPA	   1001-1052 7200-7399  PRE-1I  PRE-3 FIAT IVECO-MAGIRUS DEUTZ LAPORTE
PRESTA	RONIS		
 7700-7749 PRE-2I LAPORTE	  CHR-4I  RO-1IS  CHR-4D  RO-1DS C 001-224  RO-3	 A8..AA-DS ..8AB-ZZ S...385-402  RO-1I A9..AA-DS ..8AB-ZZ S...403-420  RO-1D CITROEN-PEUGEOT-RENAULT-TALBOT ABSA-FROSER-PJ-SADV	 ..4AB-ZZ S...331-348  RO-2I AA-JZ A4..A.A.4.  RO-4I AB-ZZ ..6 S...349-366  RO-6I ..3AB-ZZ ...1 AL 4  RO-2D AA-JZ A3..A.A.3. S...213-246  RO-4D AB-ZZ ..7 S...367-384  RO-6D
RONIS			
  C4..AA-ZY D4..AA-HR  RO-5I CITROEN-PEUGEOT ABSA	 ...151-700 E...1-1000 T...107-400 Y...101-600 ...11 1-700 A...A1-700 C...101-600 D...1-1000 T...1-380 TA...1-224 GV...1-300 ...F1-500 1F..1-21 ...151-700 E...1-1000 T...107-400 Y...101-600  RO-7I ALFA ROMEO-RENAULT	ARMOR EMHART FORINDEX KARDEX MLM NEMEF RONEO SANEL STRAFOR SCHAFER YAC T...1-380 TA...1-224 GV...1-300 ...F1-500 1F..1-21 ...151-700 E...1-1000 T...107-400 Y...101-600  RO-8I F...1-500  RO-30  RO-32D  RO-8D  RO-30D  RO-33	 ...11 1-700 A...A1-700 C...101-600 D...1-1000 T...1-380 TA...1-224 GV...1-300 ...F1-500 1F..1-21 ...151-700 E...1-1000 T...107-400 Y...101-600  RO-11I PEUGEOT-RENAULT ABSA-SADV-SIMPLEX



RONIS

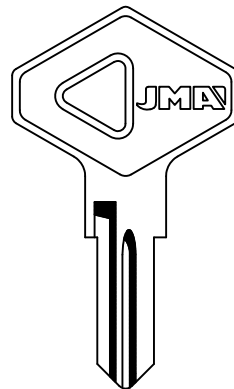
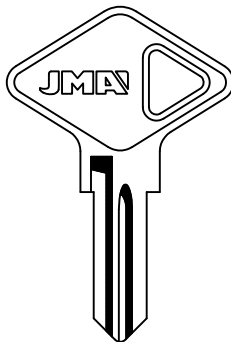
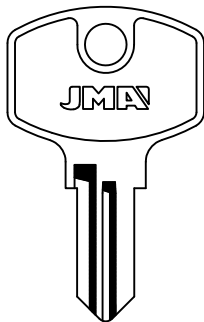
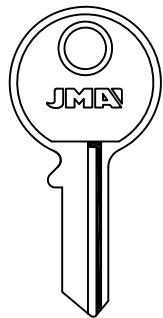

RO-12I

RO-12D

M...601-983

TAV

RO-16I

RO-16D

BURG-STRAFOR

RO-14

PEUGEOT

70.....
1 AL 3
...1-975

RO-15

ACN-ARO DACIA-RENAULT

77....
0 AL 3

RO-17

RENAULT

PARA-FOR:

RONIS (F)

ROSS (E)

SAAB (S)

SAFE (I)

ROSS

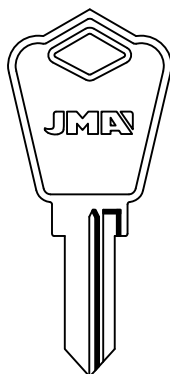
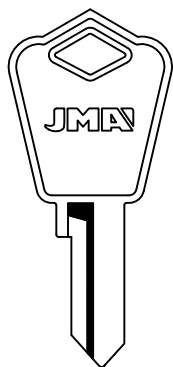

ROS-1D

ROS-2

SAAB

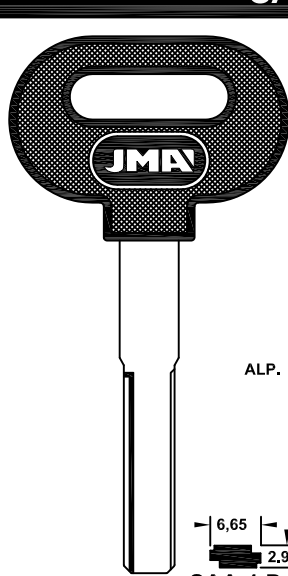

ALP.

6,65
2,9

SAAB
YMOS

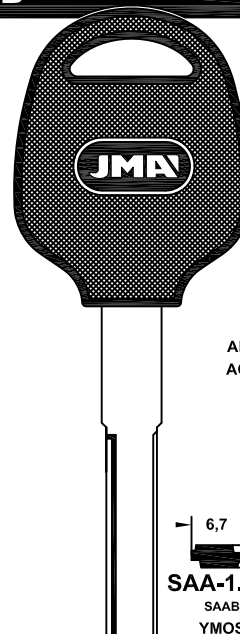

ALP.
ACE.

6,7
2,95

SAA-1.P1
SAAB
YMOS

SAAB

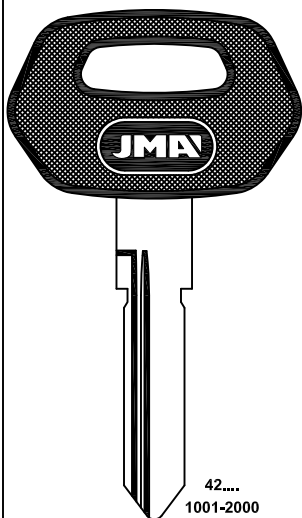

42....
1001-2000
SAA-2.P

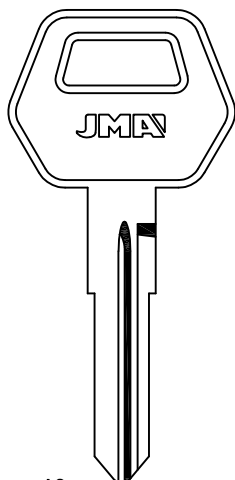

AC
1-3192
SAA-AC

SAAB
YMOS

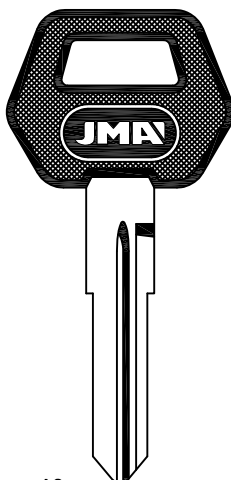

AC
1-3192
SAA-AC.P

SAAB
YMOS

SAFE

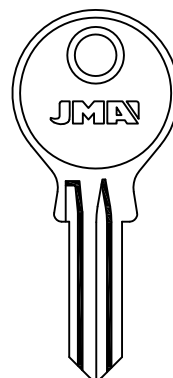

15-I 15-D

TRAMA-FIST

JMA[®]

Copyright by Alejandro Altuna S.A. 2014



ATENCIÓN: Concerniente a las marcas y denominaciones comerciales ver nota en índice.
ATTENTION: Concerning the marks and commercial denominations see note in index.
ATTENTION: Concernant les marques et dénominations commerciales voir la note dans l'index.
ACHTUNG: Beziehen auf die marke und handelsname sehen sie die notiz im index.

PARA-FOR:

SAFE (I)

SIMPLEX (F)

SAFE

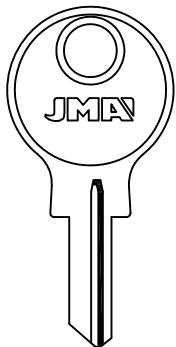

16-I

16-D

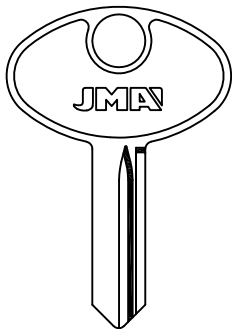

A
001-125
AF-1I

ALFA ROMEO-AUTOBIANCHI
SIPEA-MAGNETI MARELLI

B
001-125
AF-1D

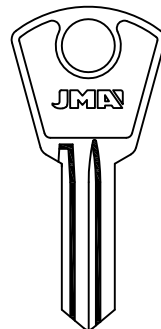

D
1-125
AF-2I

ALFA ROMEO-AUTOBIANCHI
SIPEA-MAGNETI MARELLI

C
1-125
AF-2D

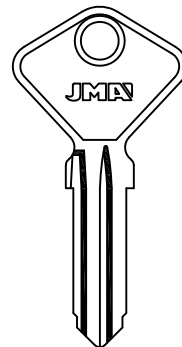

AF-3I

AF-3D

SAFE

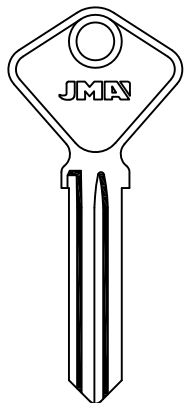

S
615-699
712-799
812-899
AF-4I

ALFA ROMEO-FIAT
FIST-TRAMA

D
115-199
212-299
312-399
AF-4D

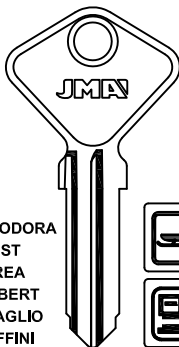

CROMODORA
FIST
FREA
GIOBERT
MIRAGLIO
RUFFINI

6
100-309
AF-5I

2
100-309
AF-6I

ALFA ROMEO-AUTOBIANCHI-FIAT



8
100-309
AF-5D

4
100-309
AF-6D

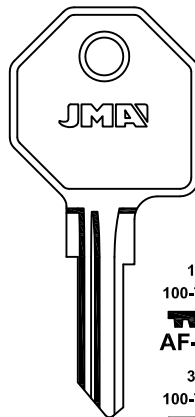

1
100-789
AF-10

3
100-789
AF-11

5
100-789
AF-12

ALFA-INNOCENTI-LANCIA-MASERATI

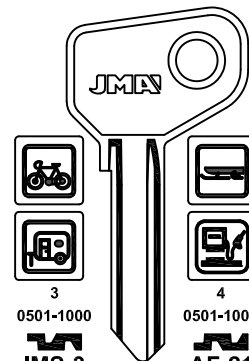

3
0501-1000
IMS-3

1
0501-1000
IMS-5

IMS-13

BLOSTER
CROMODORA-FIST-JMSA

4
0501-1000
AF-2I

2
0501-1000
AF-19

SAFE

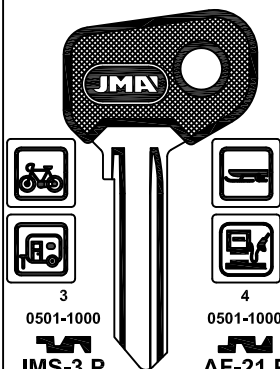

3
0501-1000
IMS-3.P

1
0501-1000
IMS-5.P

IMS-13.P

BLOSTER
CROMODORA-FIST-JMSA

4
0501-1000
AF-21.P

2
0501-1000
AF-19.P

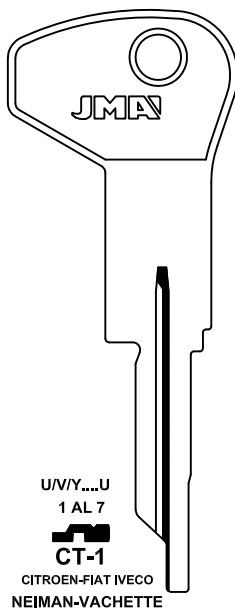

U/V/Y...U
1 AL 7
CT-1

CITROEN-FIAT IVECO
NEIMAN-VACHETTE

SIMPLEX

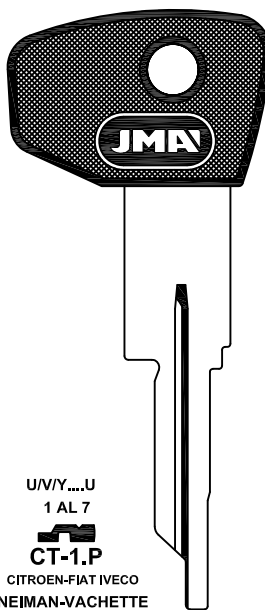

U/V/Y...U
1 AL 7
CT-1.P

CITROEN-FIAT IVECO
NEIMAN-VACHETTE

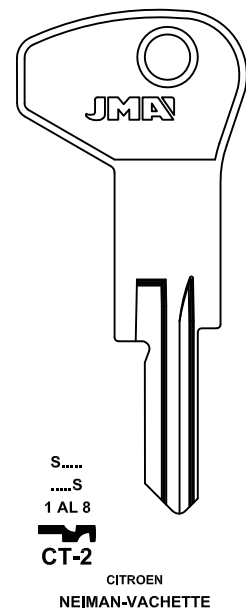

S...S
1 AL 8
CT-2

CITROEN
NEIMAN-VACHETTE



SIMPLEX

PARA-FOR:
SIMPLEX (F)

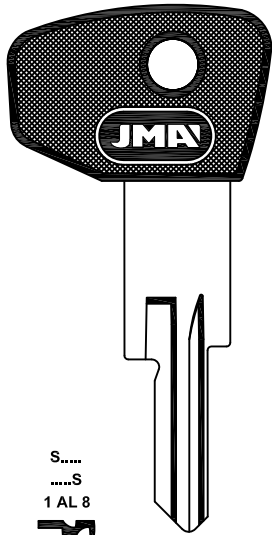

S.....
.....S
1 AL 8

CT-2.P

CITROEN
NEIMAN-VACHETTE

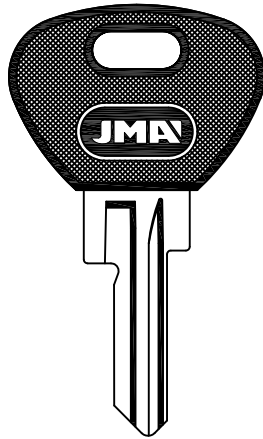

S.....
.....S
1 AL 8

CT-2.P1

CITROEN
NEIMAN-VACHETTE

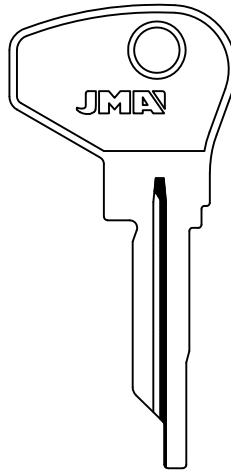

B-T.....T
1 AL 7

CT-3

CITROEN-MASERATI-FIAT IVECO
NEIMAN-VACHETTE

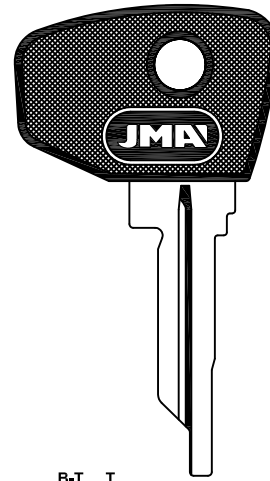

B-T.....T
1 AL 7

CT-3.P

CITROEN-MASERATI-FIAT IVECO
NEIMAN-VACHETTE

SIMPLEX

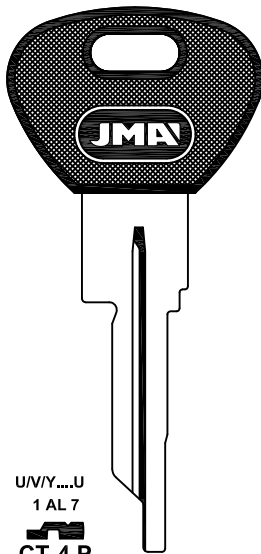

U/V/Y.....U
1 AL 7

CT-4.P

CITROEN-FIAT IVECO
NEIMAN-VACHETTE

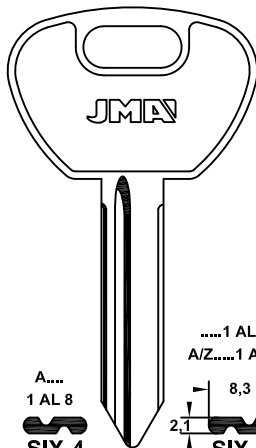

A.....
1 AL 8
SIX-4

.....1 AL 8
A/Z.....1 AL 8

8,3
2,1
SIX-1

CITROEN-PEUGEOT
NEIMAN

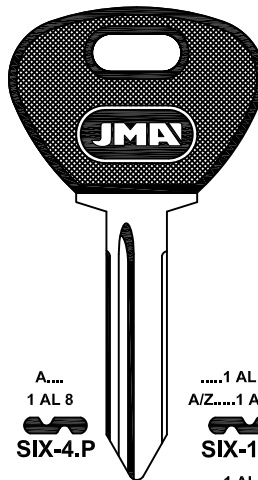

A.....
1 AL 8
SIX-4.P

.....1 AL 8
A/Z.....1 AL 8

SIX-1.P

CITROEN-PEUGEOT
NEIMAN

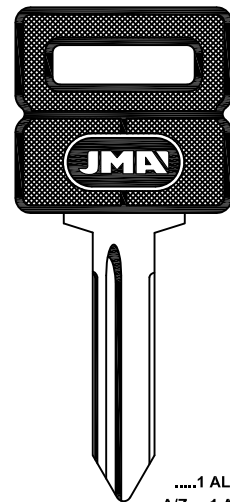

.....1 AL 8
A/Z.....1 AL 8

SIX-1.P1

CITROEN-PEUGEOT
NEIMAN

SIMPLEX

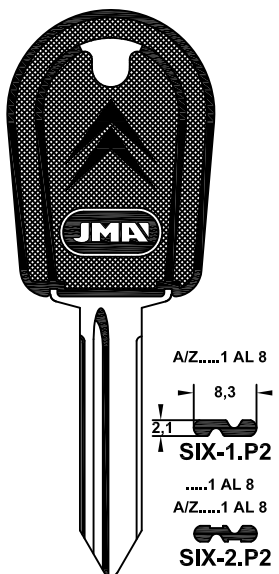

A/Z.....1 AL 8

8,3
2,1
SIX-1.P2

.....1 AL 8
A/Z.....1 AL 8

SIX-2.P2

NEIMAN

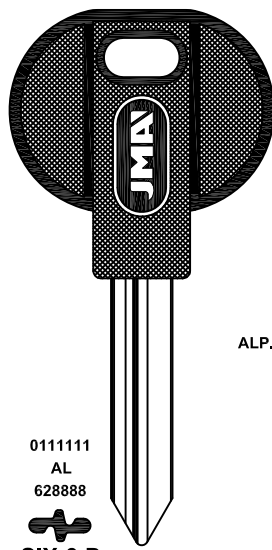

0111111
AL
628888

SIX-3.P

CITROEN

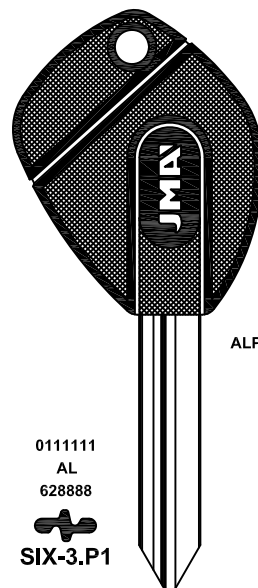

ALP.

0111111
AL
628888

SIX-3.P1

CITROEN-FIAT-LANCIA-PEUGEOT

ALP.

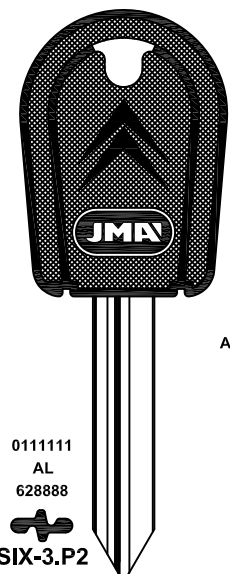

0111111
AL
628888

SIX-3.P2

CITROEN

ALP.

JMA[®]

Copyright by Alejandro Altuna S.A. 2014



ATENCIÓN: Concerniente a las marcas y denominaciones comerciales ver nota en índice.
ATTENTION: Concerning the marks and commercial denominations see note in index.
ATTENTION: Concernant les marques et denominations commerciales voir la note dans l'index.
ACHTUNG: Beziehen auf die marke und handelsname sehen sie die notiz im index.

PARA-FOR:









SIMPLEX (F)

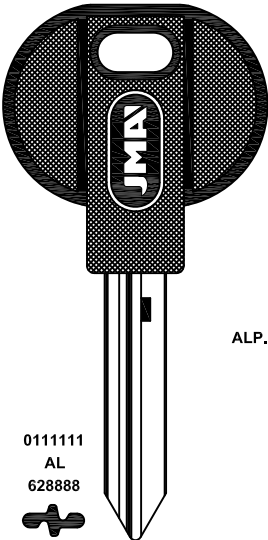

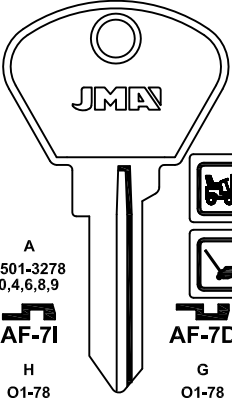
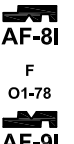

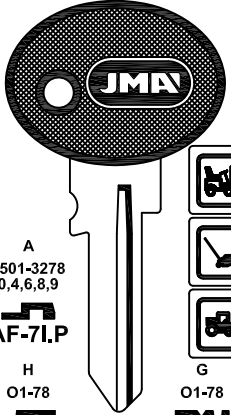

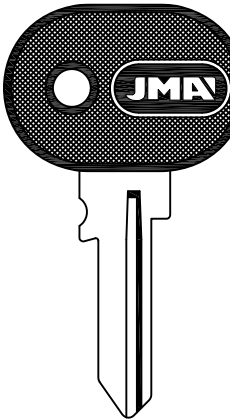
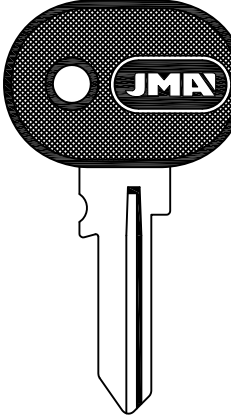
SIPEA (I)



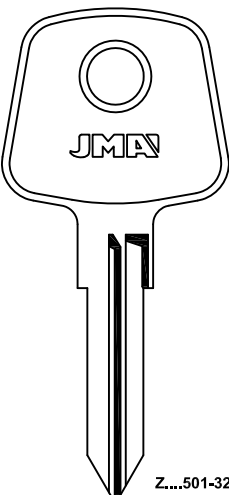

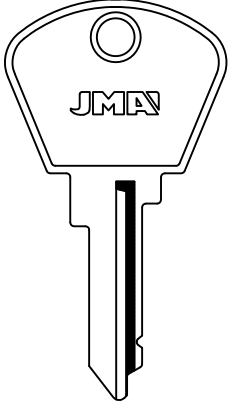
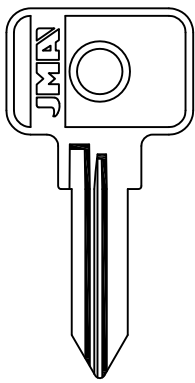

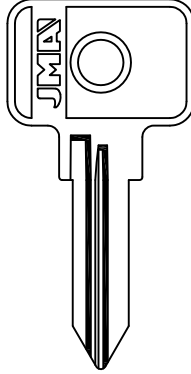
SISPA (I)

SSANGYONG

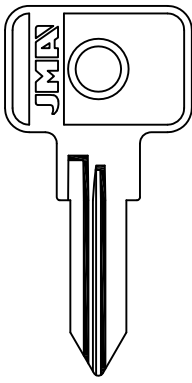
(K)

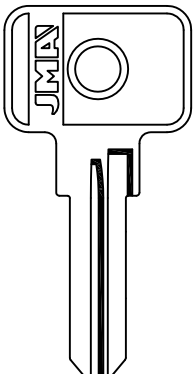
SIMPLEX	SIPEA		
 0111111 AL 628888  SIX-5.P CITROEN	 A 0501-3278 0,4,6,8,9  AF-7I H 01-78  AF-8I F 01-78  AF-9I ALFA-AUTOBIANCHI-FIAT-LANCIA SAFE	 A 0501-3278 0,4,6,8,9  AF-7I.P H 01-78  AF-8I.P F 01-78  AF-9I.P ALFA-AUTOBIANCHI-FIAT-LANCIA SAFE	 A 0501-3278 0,4,6,8,9  AF-7I.P1 FERRARI-FIAT-LAMBORGHINI-MASERATI NEIMAN

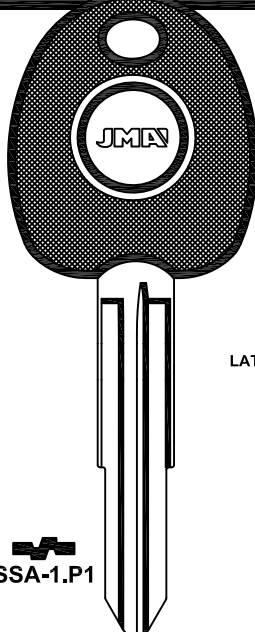
SIPEA			SISPA
 Z....501-3278 P....501-3278  SIP-1 OM IVECO-YUGO ZASTAVA-FIAT IVECO	4-6-8-9  SIP-2 FIAT-PREMIER MAGNETI MARELLI-NEIMAN	 B....501-3278 B....0-4-6-8-9  SIP-3 A.ROMEO-AUTOBIANCHI-FIAT-LANCIA ARTEB-CLAUSOR-NEIMAN	 1100-1307  SI-1D AUTOBLOCK

SISPA			SSANGYONG
  SI-3 AUTOBLOCK	  SI-4 AUTOBLOCK	  SI-5D AUTOBLOCK	 LAT.  SSA-1.P1



STREBOR

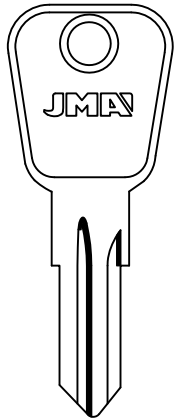

SF...101-199
SR...301-399
SS...201-299
SO...01-99



STR-3
UNION

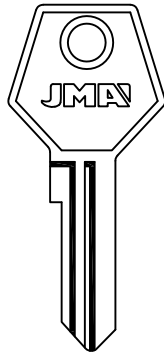

S..1-70



STR-4

STS

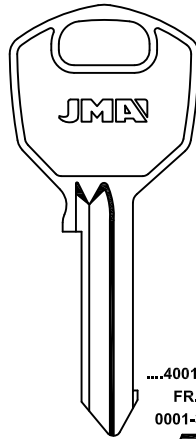

...4001-6000
FR...
0001-3040



STS-2D



EBRO-NISSAN
BLOCK-DOM

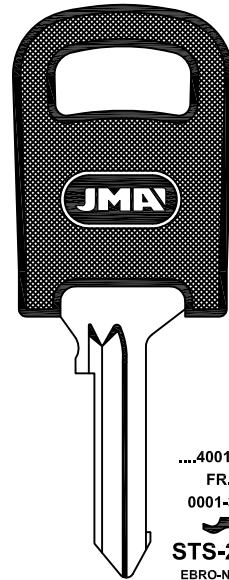

...4001-6000
FR...
0001-3040



STS-2D.P
EBRO-NISSAN
BLOCK-DOM

PARA-FOR:
STREBOR (GB)
STS (E)
SUBARU (J)
SUZUKI (J)

STS

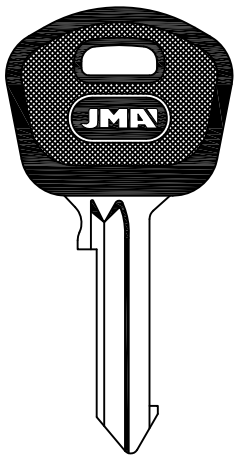

STS-5D.P
EBRO-NISSAN
DOM

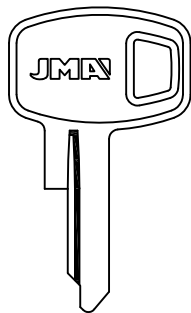

STS-11
PIAGGIO

SUBARU

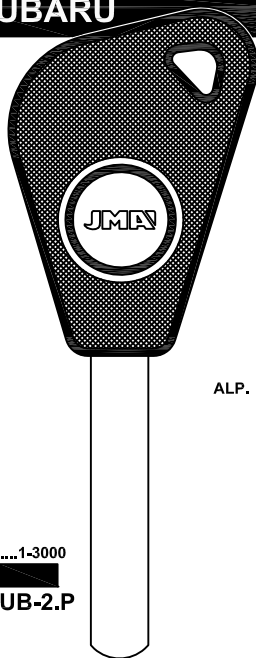

ALP.

T...1-3000



SUB-2.P

SUZUKI

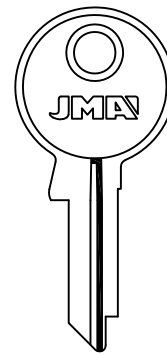

SUZU-1I



SUZU-2I

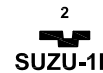

SUZU-1D



SUZU-2D

SUZUKI

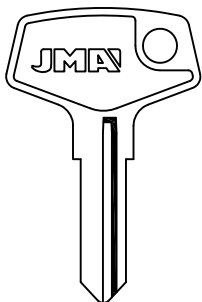

SUZU-3I
SUZUKI

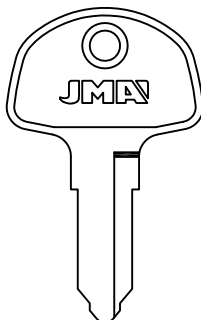

SUZU-4I

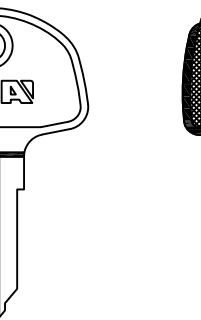

SUZU-4D

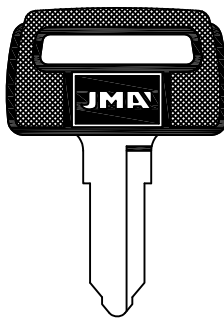

SUZU-4I.P



SUZU-4D.P

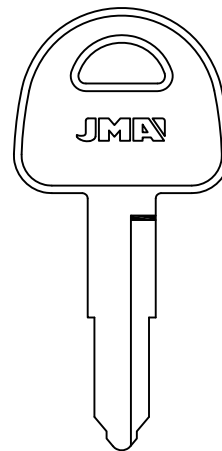

SUZU-5
BIMOTA-SUZUKI

...
101-499
751-795
A00-A99

...
101-499
751-795
A00-A99

...
101-499
751-795

BIMOTA-CAGIVA-HONDA-KAWASAKI
LAVERDA-AUGUSTA-PEUGEOT-SUZUKI



PARA-FOR:

SUZUKI (J)

SUZUKI

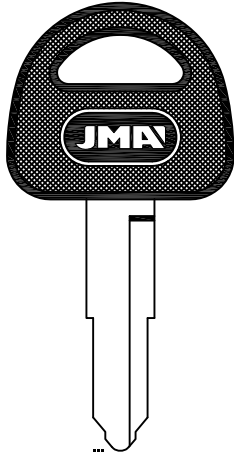

...
101-499
751-795

SUZU-5.P
BIMOTA-SUZUKI

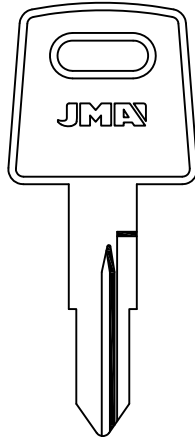

A
001-133

SUZU-6

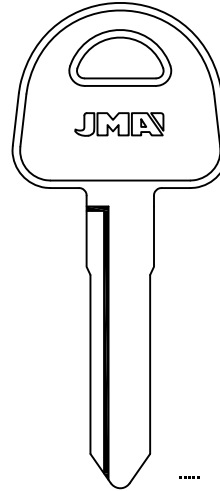

.....
16501-17704

SUZU-7
GM-MARUTI-SUZUKI



.....
16501-17704

SUZU-7.P **SUZU-7D.P**
GM-MARUTI-SUZUKI

SUZUKI

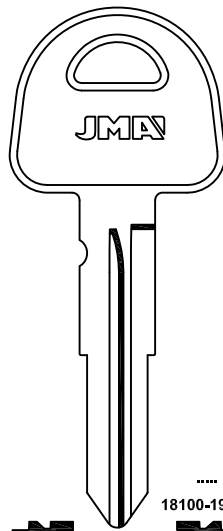

.....
18100-19229

SUZU-8I **SUZU-8**
SUZUKI

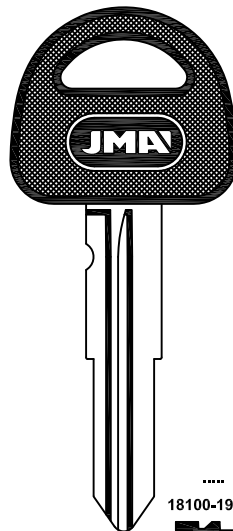

.....
18100-19229

SUZU-8.P
SUZUKI

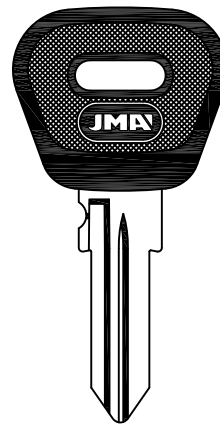

.....1 AL 5

SUZU-9.P
SUZUKI
CLAUSOR

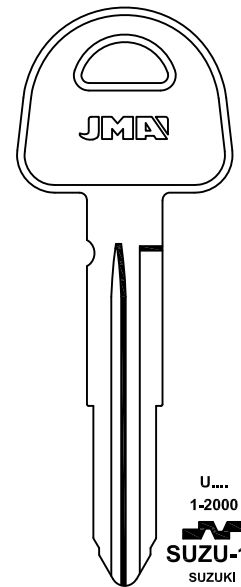

U....
1-2000

SUZU-10
SUZUKI

SUZUKI

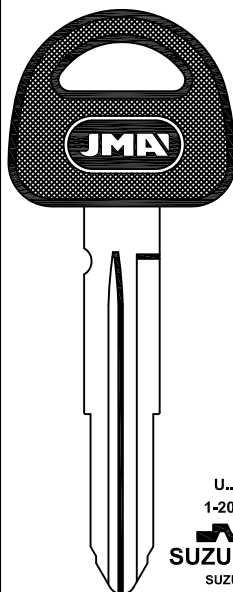

U....
1-2000

SUZU-10.P
SUZUKI

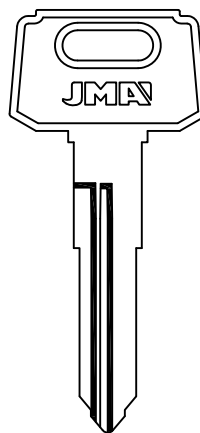

....
6001-7000

SUZU-11D
SUZUKI

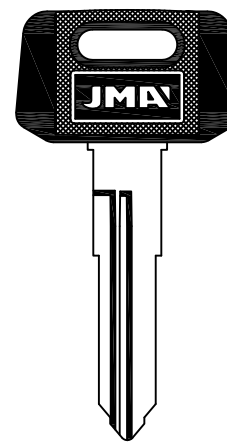

....
6001-7000

SUZU-11D.P
SUZUKI

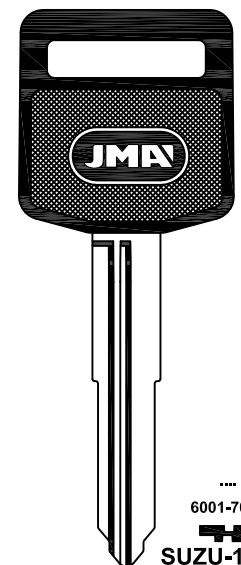

....
6001-7000

SUZU-12D.P
SUZUKI



SUZUKI

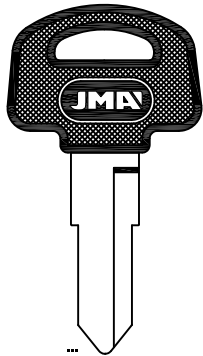

...
101-499
751-795
A00-A99
SUZU-13.P

SUZU-13D.P

BIMOTA-CAGIVA-HONDA-KAWASAKI
LAVERDA-AUGUSTA-PEUGEOT-SUZUKI

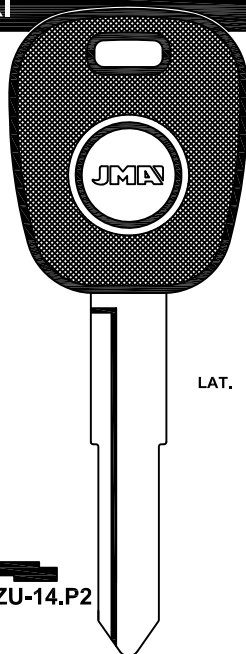

SUZU-14.P2

LAT.

TAP-AGIS



TAP-1P

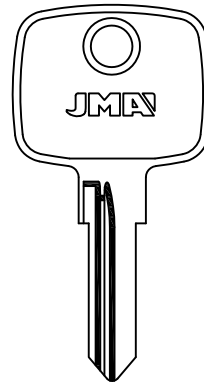

TAP-2

PARA-FOR:

- SUZUKI (J)
- TAP-AGIS (YU)
- TATA (IND)
- TECUMSEH (A)
- TIBBE (D)
- TITAN (SLO)
- TOOL BOX (USA)

TATA

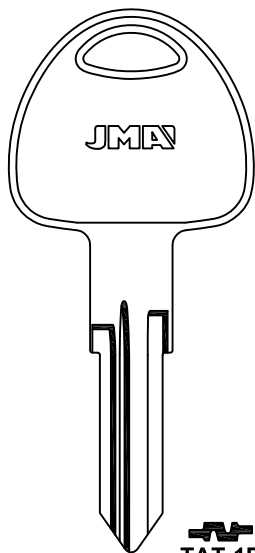

TAT-1D



TAT-1D.P

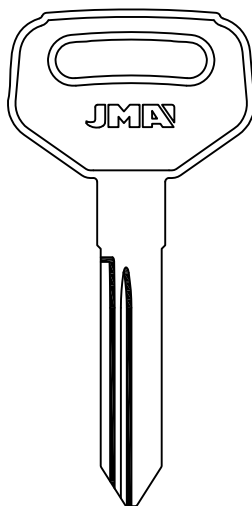

TAT-2D

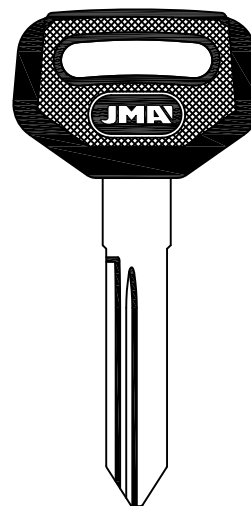

TAT-2D.P

TECUMSEH

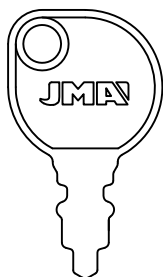

6,2 1,82
TEU-1

INDAK

TIBBE

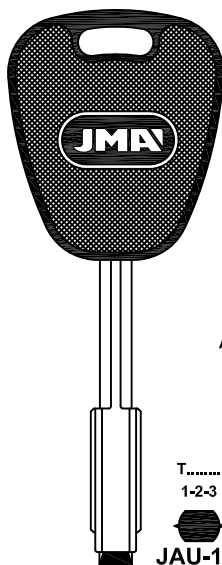

ALP.
T.....
1-2-3
JAU-1.P

TITAN

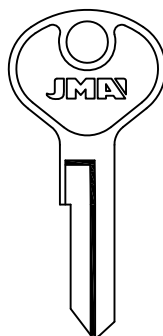

TIT-7D

TOOL BOX

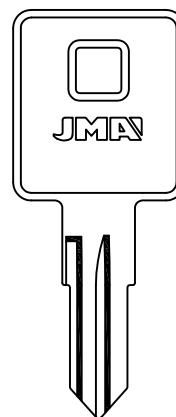





LAT.

TOO-1D

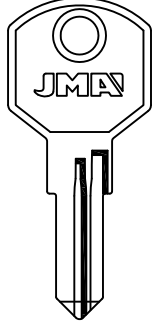
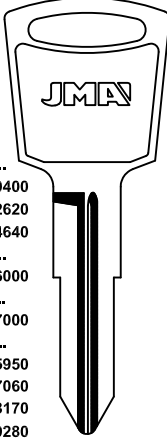
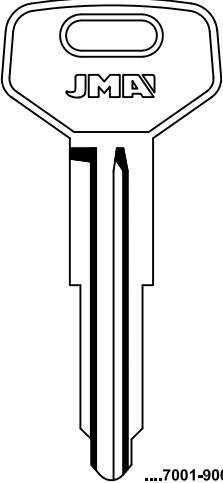
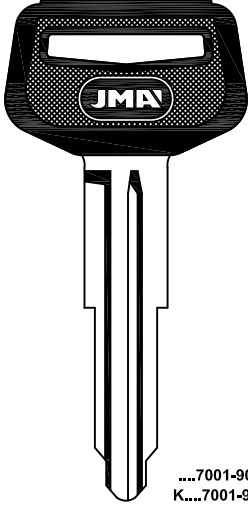

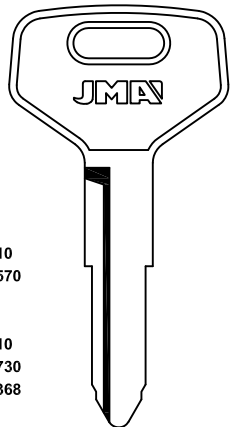
PARA-FOR:
TOOL BOX (USA)
TOYOTA (J)

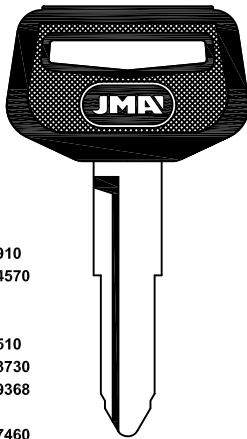
TOOL BOX	TOYOTA		
 <p>LAT.</p> <p>TOO-2</p>	<p>A.... 0001-0400 2221-2620 4441-4640 B.... 5001-6000 C.... 6001-7000 M.... 5551-5950 6661-7060 7771-8170 8814-9280 N.... 1921-2220</p>  <p>TOYO-2 GM-TOYOTA TOKAJ-RIKA</p>	 <p>....7001-9000 K....7001-9000</p> <p>TOYO-3 DAIHATSU-TOYOTA TOKAJ-RIKA</p>	 <p>....7001-9000 K....7001-9000</p> <p>TOYO-3.P DAIHATSU-TOYOTA TOKAJ-RIKA</p>

TOYOTA			
<p>K.... 001-400/1511-1910 2221-2620/3731-4570 5001-6368 R.... 401-800/1112-1510 2621-3020/3331-3730 5001-6924/8001-9368 S.... 5951-6350/7061-7460 8171-8570/9281-9680 D.... 6001-7042</p>  <p>TOYO-K1 BEDFORD-DAIHATSU-D.MOTOR-HOLDEN-HYUNDAI-SUZUKI-LOTUS-SUZUKI-HINO TOKAJ-RIKA</p>	<p>F.... 5951-6350 7061-7460 8171-8570 9281-9680 P.... 7001-8500</p>  <p>TOYO-4 C.... 6001-7042</p> <p>TOYO-14 TOKAJ-RIKA</p>	<p>K.... 001-400/1511-1910 2221-2620/3731-4570 5001-6368 R.... 401-800/1112-1510 2621-3020/3331-3730 5001-6924/8001-9368 S.... 5951-6350/7061-7460 8171-8570/9281-9680 D.... 6001-7042</p>  <p>TOYO-K1.P BEDFORD-DAIHATSU-D.MOTOR-HOLDEN-HYUNDAI-SUZUKI-LOTUS-SUZUKI-HINO TOKAJ-RIKA</p>	<p>F.... 5951-6350 7061-7460 8171-8570 9281-9680 P.... 7001-8500</p>  <p>TOYO-4.P C.... 6001-7042</p> <p>TOYO-14.P TOKAJ-RIKA</p>

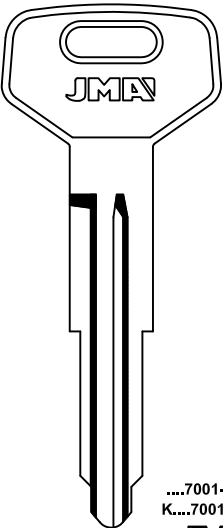
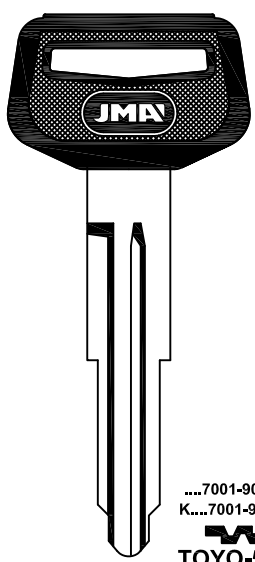
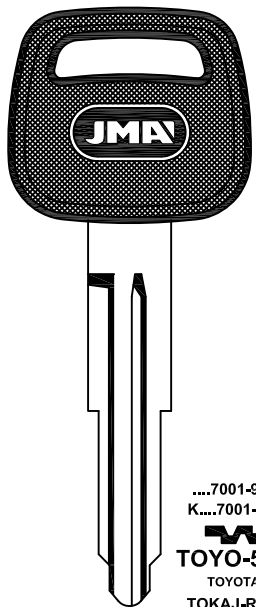
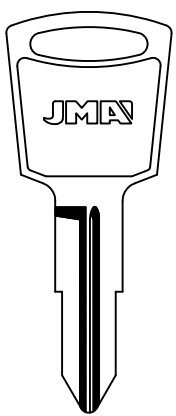
TOYOTA			
<p>....7001-9000 K....7001-9000</p>  <p>TOYO-5 TOYOTA TOKAJ-RIKA</p>	<p>....7001-9000 K....7001-9000</p>  <p>TOYO-5.P TOYOTA TOKAJ-RIKA</p>	<p>....7001-9000 K....7001-9000</p>  <p>TOYO-5.P1 TOYOTA TOKAJ-RIKA</p>	 <p>TOYO-6 TOKAJ-RIKA</p>



TOYOTA

PARA-FOR:

TOYOTA (J)

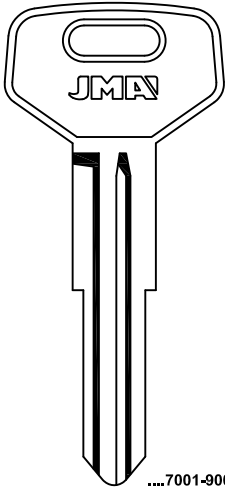

....7001-9000
K....7001-9000



TOYO-8

DAIHATSU-TOYOTA
TOKAJ-RIKA

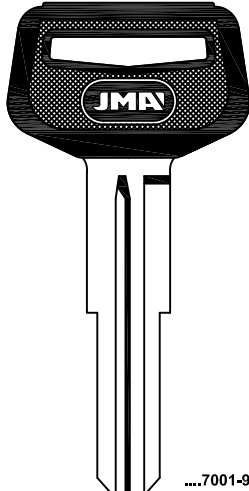

....7001-9000
K....7001-9000



TOYO-8LP

DAIHATSU-TOYOTA
TOKAJ-RIKA

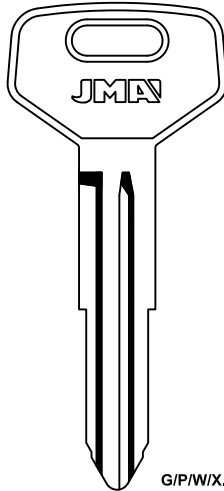

G/P/W/X....
1-2000



TOYO-9

TOYOTA-VOLKSWAGEN
TOKAJ-RIKA

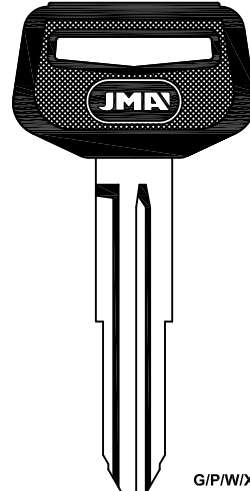

G/P/W/X....
1-2000



TOYO-9.P

TOYOTA-VOLKSWAGEN
TOKAJ-RIKA

TOYOTA

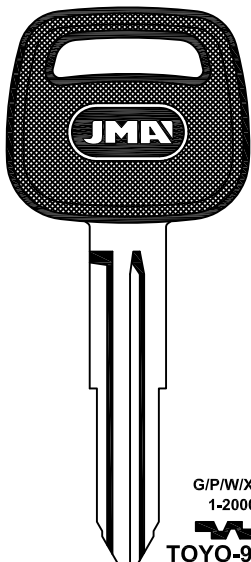

G/P/W/X....
1-2000



TOYO-9.P1

TOYOTA-VOLKSWAGEN
TOKAJ-RIKA

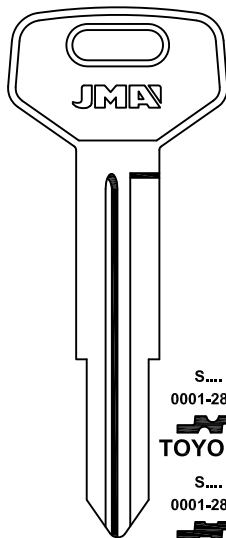

S....
0001-2878



TOYO-10

S....
0001-2878



TOYO-11

TOYOTA
TOKAJ-RIKA

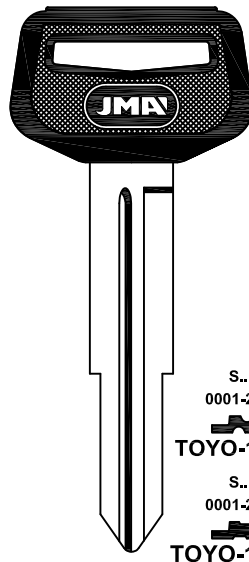

S....
0001-2878



TOYO-10.P

S....
0001-2878



TOYO-11.P

TOYOTA
TOKAJ-RIKA

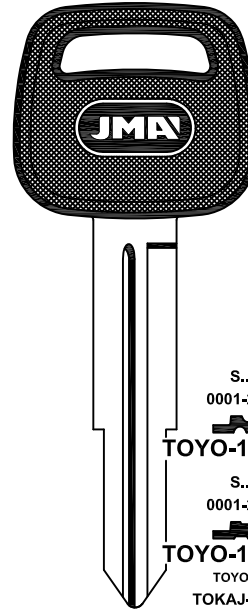

S....
0001-2878



TOYO-10.P1

S....
0001-2878



TOYO-11.P1

TOYOTA
TOKAJ-RIKA

TOYOTA

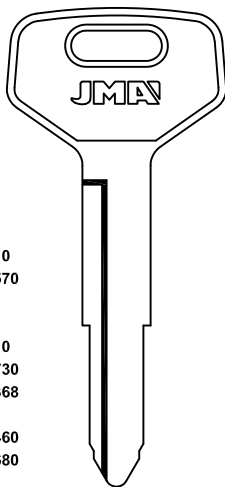

K....
001-400/1511-1910
2221-2620/3731-4570
5001-6368

R....
401-800/1112-1510
2621-3020/3331-3730
5001-6924/8001-9368

S....
5951-6350/7061-7460
8171-8570/9281-9680

D....
6001-7042

TOYO-12

TOYOTA
TOKAJ-RIKA

F....
5951-6350
7061-7460
8171-8570
9281-9680

P....
7001-8500

TOYO-13

C....
6001-8042

U....
3001-4000

Z....
1-1000

TOYO-12D

K....
001-400/1511-1910
2221-2620/3731-4570
5001-6368

R....
401-800/1112-1510
2621-3020/3331-3730
5001-6924/8001-9368

S....
5951-6350/7061-7460
8171-8570/9281-9680

D....
6001-7042

TOYO-12.P1

TOYOTA
TOKAJ-RIKA

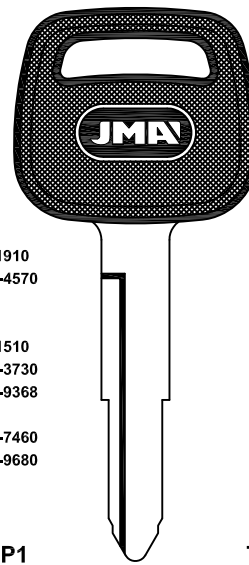

F....
5951-6350
7061-7460
8171-8570
9281-9680

P....
7001-8500

TOYO-13.P1

C....
6001-8042

U....
3001-4000

Z....
1-1000

TOYO-12D.P1



PARA-FOR:

TOYOTA (J)

TOYOTA

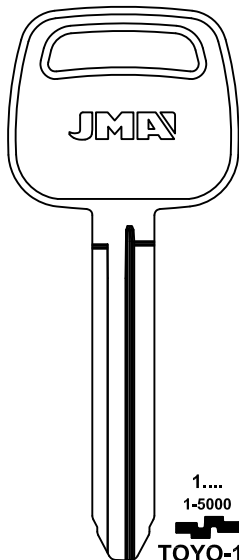

GM-TOYOTA
TOKAJ-RIKA

1....
1-5000

TOYO-15

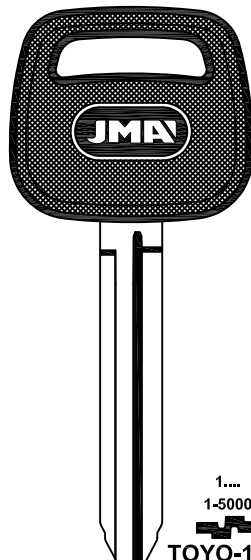

GM-TOYOTA
TOKAJ-RIKA

1....
1-5000

TOYO-15.P

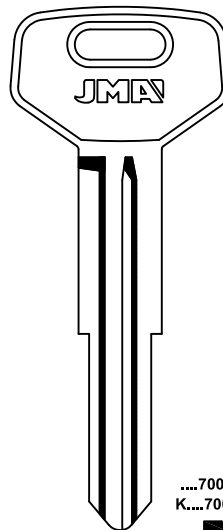

TOYOTA
TOKAJ-RIKA

....7001-9000
K....7001-9000

TOYO-16

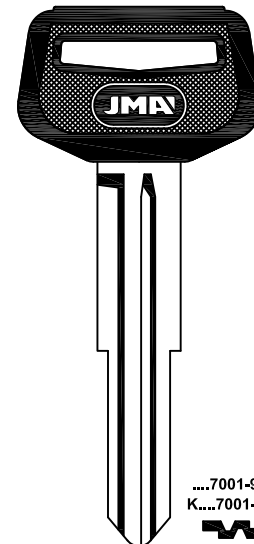

TOYOTA
TOKAJ-RIKA

....7001-9000
K....7001-9000

TOYO-16.P

TOYOTA

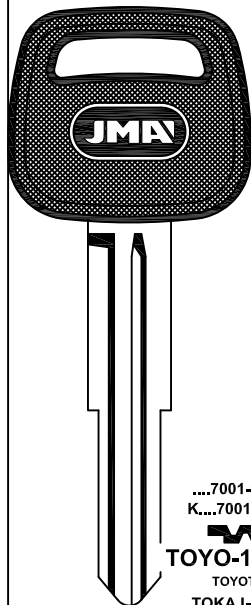

....7001-9000
K....7001-9000

TOYO-16.P1

TOYOTA
TOKAJ-RIKA

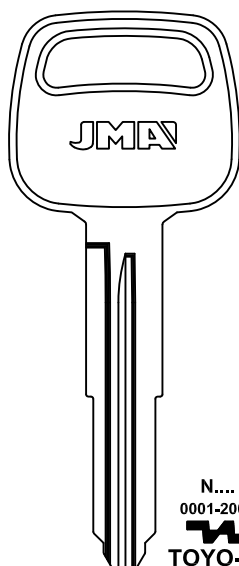

TOKAJ-RIKA

N....
0001-2000

TOYO-17

TOYOTA

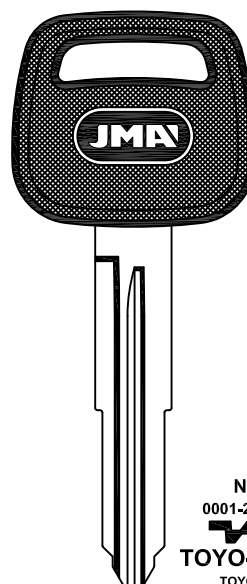

TOKAJ-RIKA

N
0001-2000

TOYO-17.P

TOYOTA



LAT.
1 7,8
3

TOYO-18.P

LEXUS-MAZDA-TOYOTA
TOKAJ-RIKA

TOYOTA

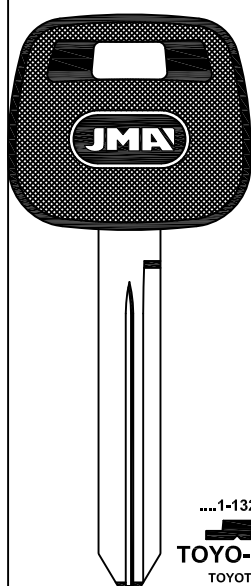

....1-13284

TOYO-19.P

TOYOTA
VALEO

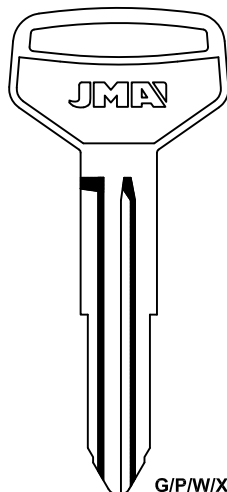

TOYOTA-VOLKSWAGEN
TOKAJ-RIKA

G/P/W/X....
1-2000

TOYO-20D

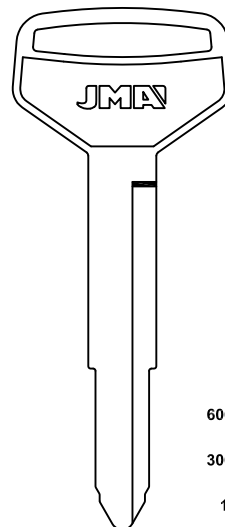

TOYOTA
TOKAJ-RIKA

C....
6001-8042
U....
3001-4000
Z....
1-1000

TOYO-22

K....
001-400/1511-1910
2221-2620/3731-4570
5001-6368
R....
401-800/1112-1510
2621-3020/3331-3730
5001-6924/8001-9368
S....
5951-6350/7061-7460
8171-8570/9281-9680
D....
6001-7042

TOYO-22D



TOYOTA

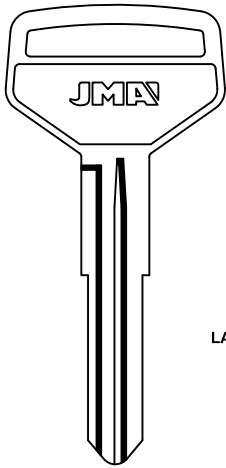

1001-2500
3001-4500
 TOYO-23
TOKAJ-RIKA

LAT.

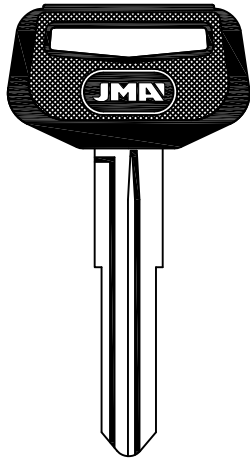

1001-2500
3001-4500
 TOYO-23.P
TOKAJ-RIKA

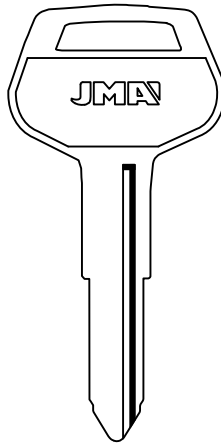

TOYO-24

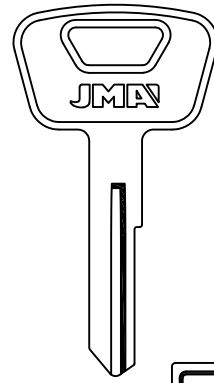

11121-15543
51112-55424
5....
 TOYO-25



TOYOTA

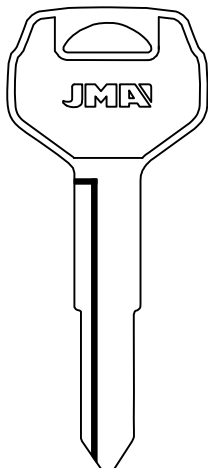

K....1-4130
R....401-3790
 TOYO-26

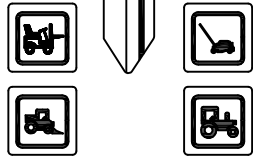
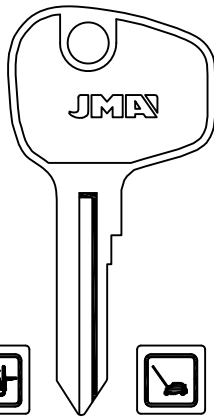

TOYO-27
HINO

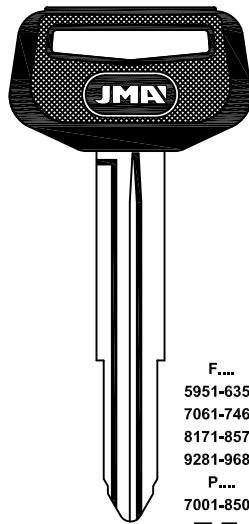

F....
5951-6350
7061-7460
8171-8570
9281-9680
P....
7001-8500
 TOYO-28.P

TOKAJ-RIKA

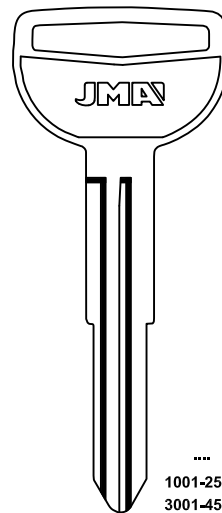

....
1001-2500
3001-4500
 TOYO-29

TOYOTA



7.8
3
 TOYO-30.P1

LAT.

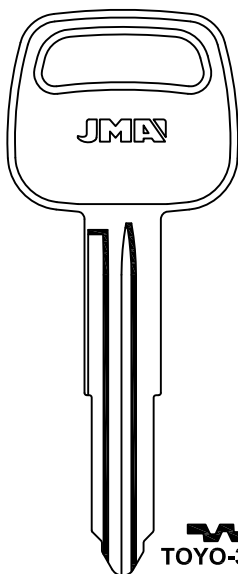

TOYO-37D

TRELOCK

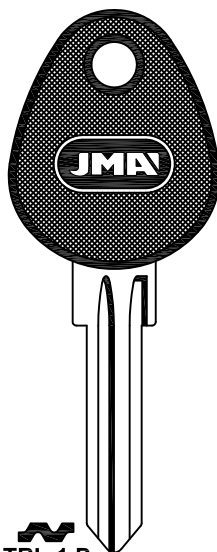

TRL-1.P

TRIUMPH MOT.

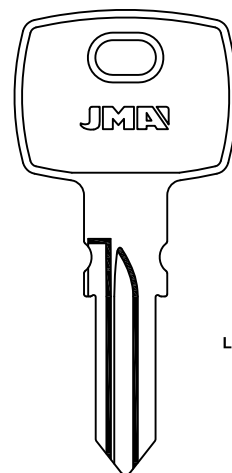

TRP-1D

LAT.

ZADI

PARA-FOR:



- TOYOTA (J)
- TRELOCK (D)
- TRIUMPH MOT. (USA)







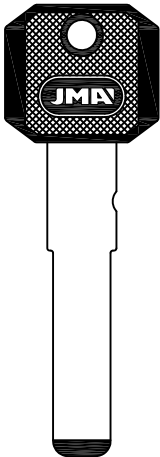





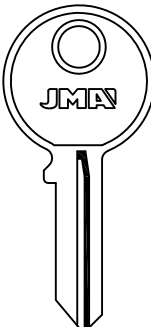





PARA-FOR:

TRW-SIPEA (I)



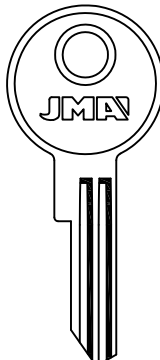
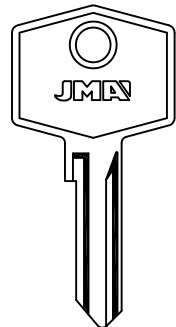



UNION (GB)

TRW-SIPEA		UNION	
	ALP.		LAT.
	FI-16C1		FI-16.P1
			GIOBERT

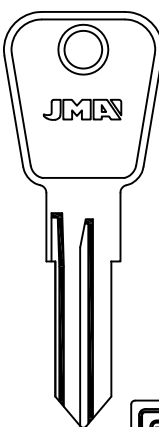
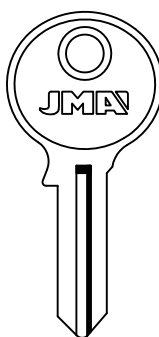
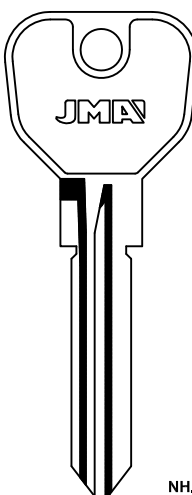
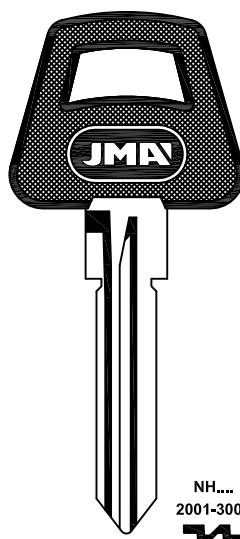
UNION

	<p>NRA FFE...1-100 FJA...1-100 FL...251-500 NRA...51-90 YFB...1-75 FMD...1-75 FG...1-30 NF...1-30 EJR...1-75</p> <p> UN-FFE</p> <p>MC...1-40 MRA...251-290 MRN...1-54 MRN...201-250 MRN...251-300</p> <p> UN-MRN</p> <p>FS...1-99 FS...876-955</p> <p> UN-1FS</p>	<p> </p> <p> UN-3</p> <p>FP... 626-750</p> <p> UN-FP</p> <p>FR... 751-875</p> <p> UN-FR</p> <p>HX...100</p> <p> UN-2</p> <p>RM... 911-952</p> <p> UN-44D</p> <p>NGN...1-54</p> <p> UN-NG</p>		
	<p>BRITISH LEYLAND-FORD-HILLMAN-JAGUAR-LAND ROVER-MG-MORRIS-ROVER</p>		<p> </p> <p>FK... 01-99 876-955</p> <p> UN-FK</p> <p>FS... 01-99 876-955</p> <p> UN-FS</p> <p>JAGUAR-VAUXHALL</p>	

UNION

			
<p>FT-BC...301-360 BC-FT...101-225 LF...451-575 CB...801-875</p> <p> UN-FT</p> <p>BEDFORD-B.LEYLAND-FORD CEM</p>	<p>TF TF...1001-1140</p> <p> UN-TF</p> <p>NC... 1-1000</p> <p> UN-NC</p>	<p>NH... 2001-3000</p> <p> UN-NH</p> <p>MG-ROVER-TRIUMPH CEM</p>	<p>NH... 2001-3000</p> <p> UN-NH.P</p> <p>MG-ROVER-TRIUMPH CEM</p>



VACHETTE

PARA-FOR:

VACHETTE (F)

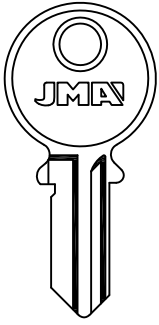

....1 AL 9 AL 0
E...9001-9100
....R9001-9100



VA-3I



VA-3

ISEO-KLIT

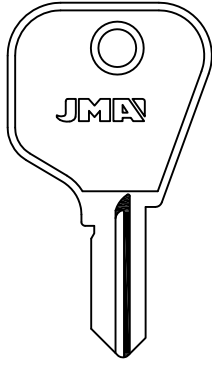

E...
001-649



VA-6

CITROEN-PEUGEOT-TALBOT SIMCA

SIMPLEX

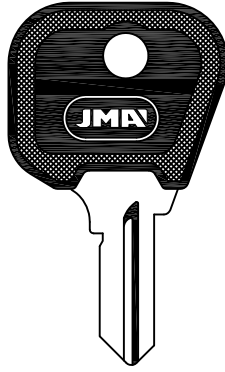

E...
001-649



VA-6.P

CITROEN-PEUGEOT-TALBOT SIMCA

SIMPLEX

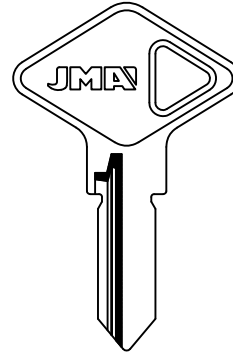

1R...000-999
2R...1000-1837
3R...000-665



VA-7

RENAULT-TALBOT SIMCA

VACHETTE

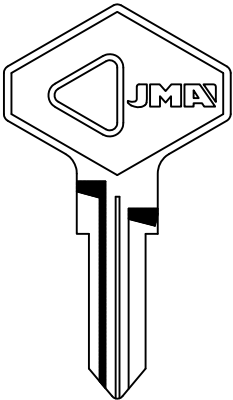

A/Z...
...A/Z
...A/Z 1/9
2700-4816



VA-10

A.MOTORS-CHRYSLER-RENAULT

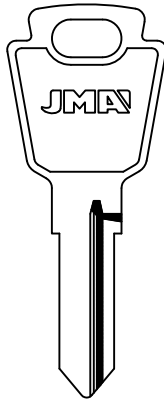

A...000-999
B...000-999
F...000-116



VA-16

TALBOT SIMCA

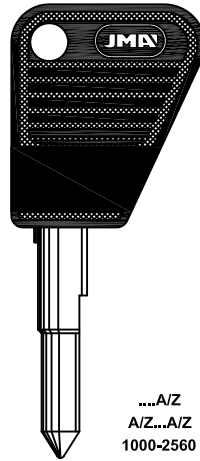

LAT.

...A/Z
A/Z...A/Z
1000-2560
.E...A/Z 0 AL 4



VA-17.P

RENAULT
NEIMAN

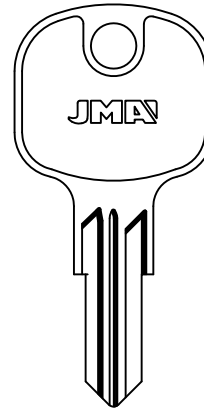

...E
001-649



VA-18

PEUGEOT

VACHETTE

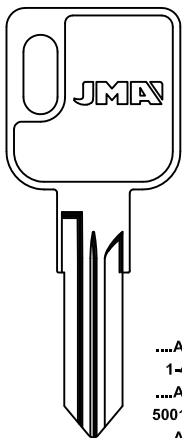

....A/Z 0/9
1-4092
....A/Z 0/9
5001-9092
....A/Z 0/9
1-4092
...A/Z 0/9
5001-9092



VA-34

RENAULT

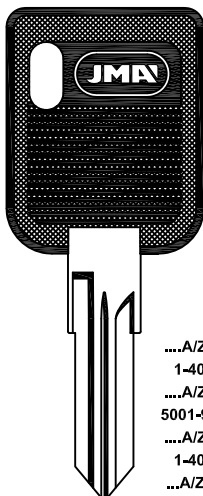

....A/Z 0/9
1-4092
....A/Z 0/9
5001-9092
....A/Z 0/9
1-4092
...A/Z 0/9
5001-9092



VA-34.P

RENAULT

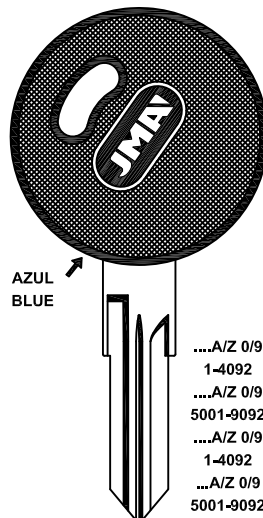

AZUL
BLUE

....A/Z 0/9
1-4092
....A/Z 0/9
5001-9092
....A/Z 0/9
1-4092
...A/Z 0/9
5001-9092



VA-34.P1

RENAULT



....A/Z 0/9
1-4092
....A/Z 0/9
5001-9092
....A/Z 0/9
1-4092
...A/Z 0/9
5001-9092



VA-61C1

JMA[®]

Copyright by Alejandro Altuna S.A. 2014



ATENCIÓN: Concerniente a las marcas y denominaciones comerciales ver nota en índice.
ATTENTION: Concerning the marks and commercial denominations see note in index.
ATTENTION: Concernant les marques et dénominations commerciales voir la note dans l'index.
ACHTUNG: Beziehen auf die marke und handelsname sehen sie die notiz im index.











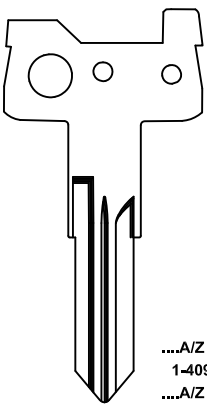



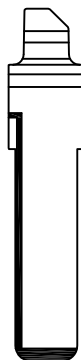



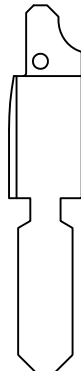

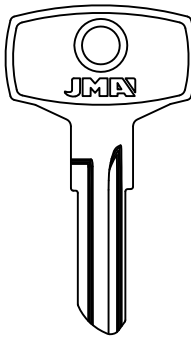

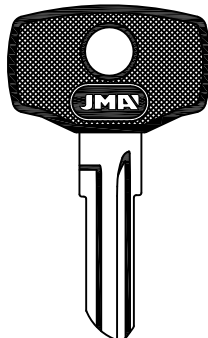

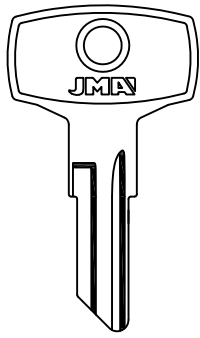

PARA-FOR:

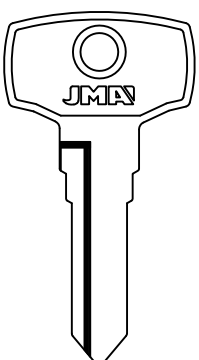
VACHETTE (F)

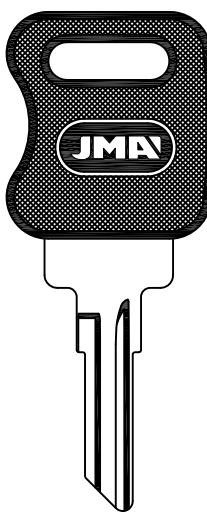
VALEO (F)

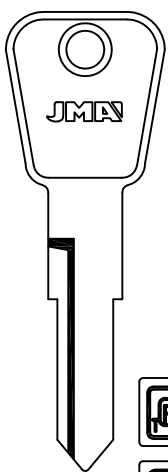
VOLGA (RUS)

WASO (D)

VACHETTE	VALEO		
 <p>....A/Z 0/9 1-4092A/Z 0/9 5001-9092A/Z 0/9 1-4092 ...A/Z 0/9 5001-9092</p>  <p>VA-61C2</p>	 <p>ALP.</p>  <p>HU-HAAC3</p>	 <p>ALP.</p>  <p>HU-HAAC4</p>	 <p>ALP.</p>  <p>PEU-1C1</p>
VALEO	VOLGA		
 <p>ALP.</p>  <p>PEU-2C1</p>	 <p>JMA</p>  <p>VOL-1</p>	 <p>JMA</p>  <p>VOL-1.P</p>	 <p>JMA</p>  <p>VOL-2</p>  <p>VOL-2D</p>  <p>VOL-3</p> <p>GAZ-ZAZ</p>
VOLGA		WASO	
 <p>JMA</p>  <p>VOL-4</p>	 <p>JMA</p>  <p>VOL-5.P</p>	 <p>JMA</p>  <p>W... 600-842</p>  <p>WAS-1</p> <p>JAGUAR-ROVER-SAAB-VOLVO</p>	 <p>JMA</p> <p>FR...4001-6000 FZ...1-1232</p>  <p>WAS-2.P</p> <p>JAGUAR-MAZDA-SUBARU-TRIUMPH ARMAN-DOM</p>



WASO

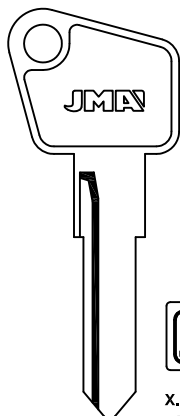

X...1-4088



WAS-3

D...1-4088

X...1-4088



WAS-4

DAF

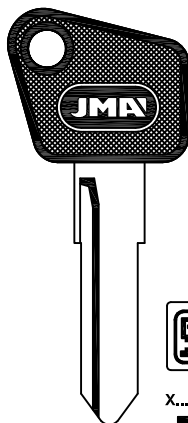

X...1-4088



WAS-3.P

D...1-4088

X...1-4088



WAS-4.P

DAF

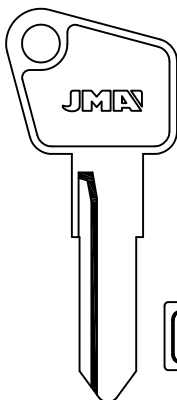

W...600-842



WAS-5

M...100-174



WAS-6

LOTUS-BEDFORD-DAF



W...600-842



WAS-5.P

M...100-174



WAS-6.P

LOTUS-BEDFORD-DAF

PARA-FOR:

WASO (D)

WEST LOCK (USA)

WITTE (D)

YALE (D-GB-USA)

WASO

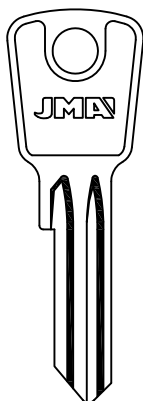

A.....

0 AL 5



WAS-7I

TOK

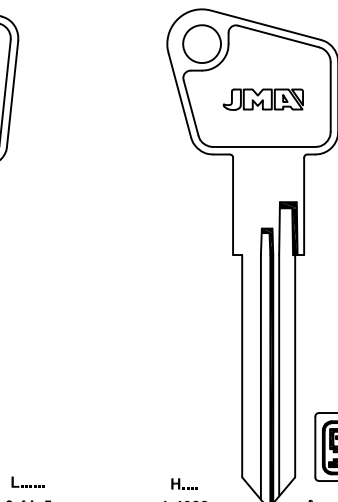

H.....

1-4088



WAS-8

UNIPART

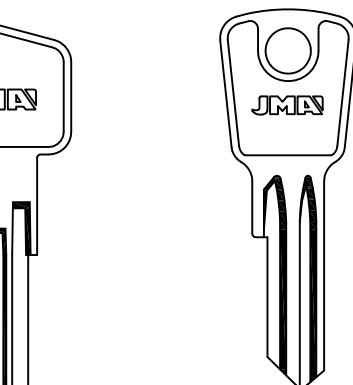

B.....

L.....

0 AL 5



WAS-9

TOK WINKHAUS



B.....

L.....

0 AL 5



WAS-10.P

TRELOCK



B.....

L.....

0 AL 5



WAS-10D.P

WEST LOCK

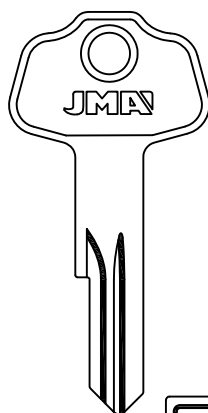

V.....

1 AL 6



WST-1D

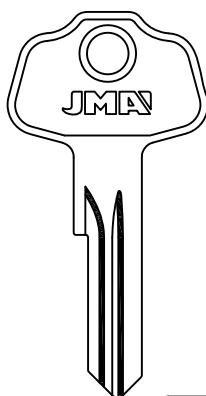

V.....

1 AL 6



WST-2D

WITTE

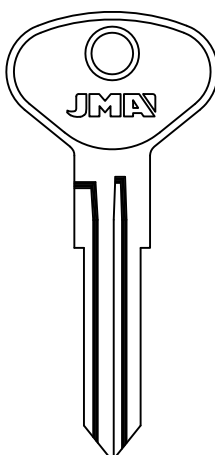

8001-8100



WIT-1

YALE

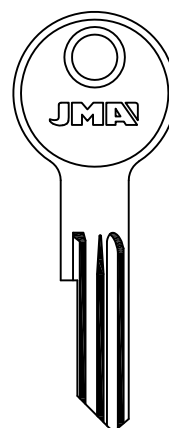

RRL



YA-18D

ROLLS ROYCE



PARA-FOR:
 YALE (D-GB-USA)
 YAMAHA (J)

YALE

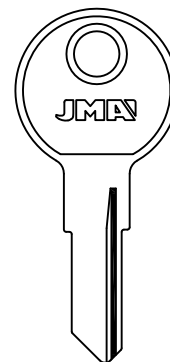
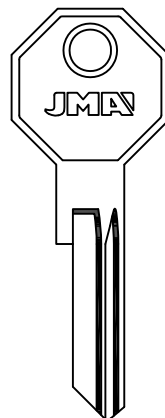
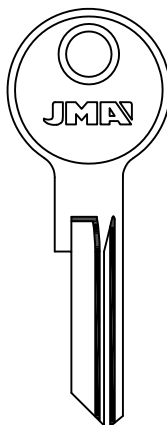
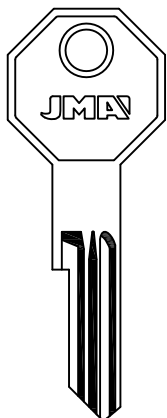

RRM
YA-19D
 ROLLS ROYCE

NRRL
YA-20I **YA-20D**
 ROLLS ROYCE

NRRM
YA-21I **YA-21D**
 ROLLS ROYCE

YA-37 **YA-37D**
 ADEMCO-BENDIX-CHICAGO
 FORT-ILLINOIS

YAMAHA

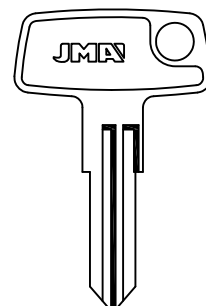
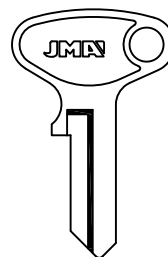
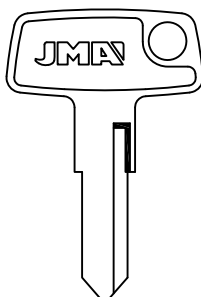
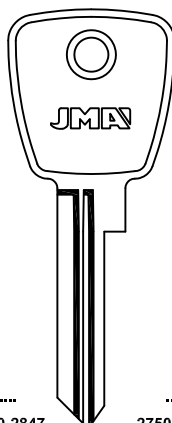

....
 2840-2847 **YAMA-1I**
 2550-2557 **YAMA-2I**
 YAMAHA

....
 2750-2757 **YAMA-1D**
 2640-2647 **YAMA-2D**
 YAMAHA

....
 2611-2650 **YAMA-3I**
 YAMAHA

....
 1711-1725 **YAMA-3D**
 YAMAHA

YAMA-4D
 YAMAHA

....
 2651-2675 **YAMA-5I**
 YAMAHA

....
 1751-1775 **YAMA-5D**
 YAMAHA

YAMAHA

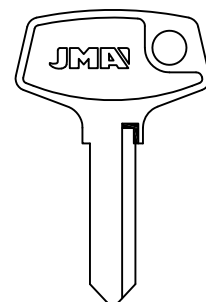
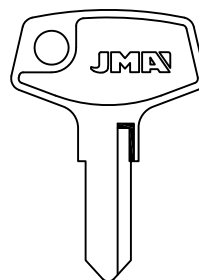
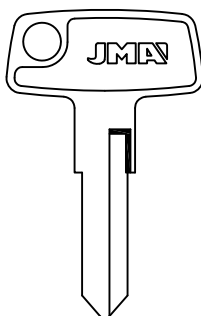
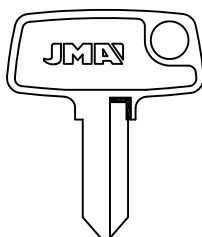

....
 228-234 **YAMA-6I**
 YAMAHA

....
 221-227 **YAMA-6D**
 YAMAHA

....
 2676-2700 **YAMA-7I**
 YAMAHA

....
 1776-1800 **YAMA-7D**
 YAMAHA

....
 2109-2115 **YAMA-8I**
 YAMAHA

....
 1209-1215 **YAMA-8D**
 YAMAHA

....
 A201-A206 **YAMA-9I**
 YAMAHA

....
 B201-B206 **YAMA-9D**
 YAMAHA



YAMAHA

PARA-FOR:

YAMAHA (J)

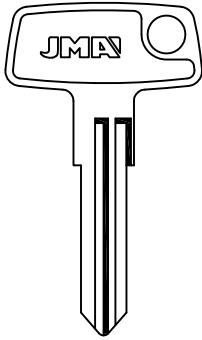

....
2765-2771

YAMA-10I

....
1855-1861

YAMA-10D

....
2758-2764

YAMA-11I

....
1848-1854

YAMA-11D

YAMAHA

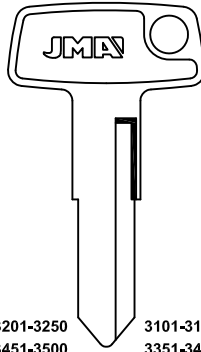

3201-3250
3451-3500
4401-4450

YAMA-12I

3101-3150
3351-3400
4301-4350

YAMA-12D

3251-3300
3851-3900
4451-4500

YAMA-13I

3151-3200
3751-3800
4351-4400

YAMA-13D

3801-3850
4251-4300
4851-4900

YAMA-14I

3401-3450
4051-4100
4651-4700

YAMA-15I

3651-3700
4201-4250
4801-4850

YAMA-16I

3551-3600
4101-4150
4701-4750

YAMA-17I

3701-3750
4151-4200
4751-4800

YAMA-14D

3301-3350
3951-4000
4551-4600

YAMA-15D

3551-3600
4101-4150
4701-4750

YAMA-16D

3501-3550
3901-3950
4501-4550

YAMA-17D

YAMAHA

YAMAHA

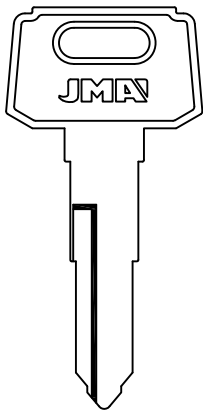

1 AL 4
32010-79897

A.....
32010-79897

YAMA-18I

B.....
32010-79897

YAMA-18D

C.....
32010-79897

YAMA-19I

D.....
32010-79897

YAMA-19D

E.....
32010-79897

YAMA-20I

F.....
32010-79897

YAMA-20D

MALAGUTI-SUZUKI-YAMAHA

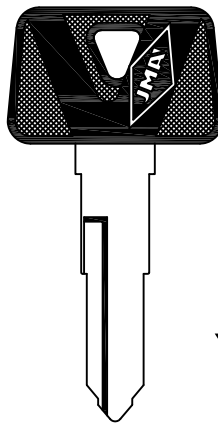

1 AL 4
32010-79897

A.....
32010-79897

YAMA-18I.P

B.....
32010-79897

YAMA-18D.P

C.....
32010-79897

YAMA-19I.P

D.....
32010-79897

YAMA-19D.P

E.....
32010-79897

YAMA-20I.P

F.....
32010-79897

YAMA-20D.P

MALAGUTI-SUZUKI-YAMAHA

YAMAHA

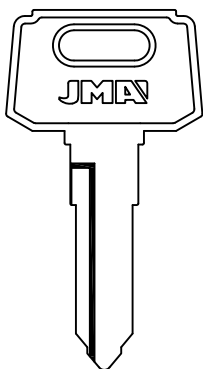

....
7001-8000

YAMA-21I

HERCULES-YAMAHA

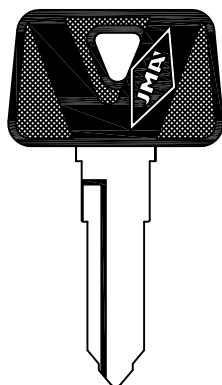

....
7001-7999

YAMA-21I.P

HERCULES-YAMAHA

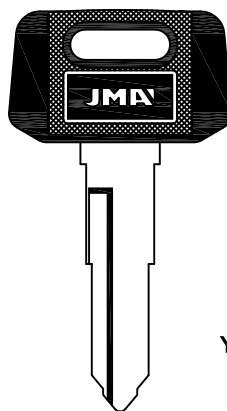

1 AL 4
32010-79897

A.....
32010-79897

YAMA-22I.P

B.....
32010-79897

YAMA-22D.P

C.....
32010-79897

YAMA-23I.P

D.....
32010-79897

YAMA-23D.P

E.....
32010-79897

YAMA-24I.P

F.....
32010-79897

YAMA-24D.P

YAMAHA



PARA-FOR:

YAMAHA (J)

YUGO (YU)

YMS (TW)

ZADI (I)

YAMAHA

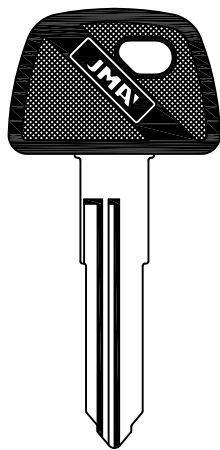

....
6001-7000

YAMA-25D.P
PUCH-VESPA-YAMAHA

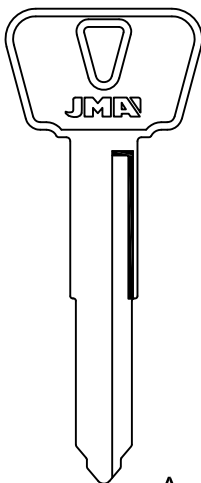

A....
7000-8000

YAMA-26
YAMAHA

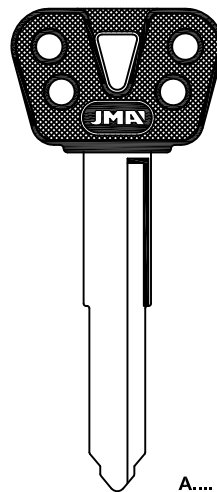

A....
7000-8000

YAMA-26P
YAMAHA

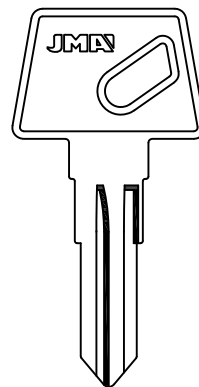

....3000

YAMA-27
ITALJET-MALAGUTI-MBK-YAMAHA

....7000

YAMA-27D

YAMAHA

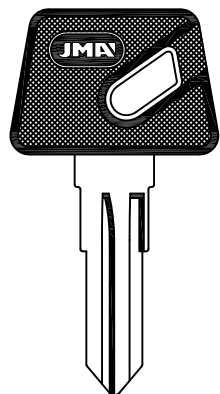

....3000 **YAMA-27P**
....7000 **YAMA-27DP**

....4000 **YAMA-30.P**
ITALJET-MALAGUTI-MBK-YAMAHA

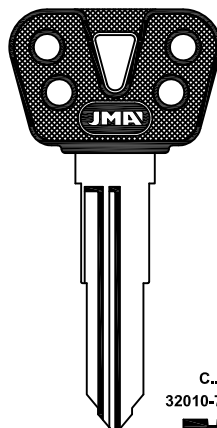

C....
32010-79897
 YAMA-28.P

E....
32010-79897
 YAMA-29.P
YAMAHA

YUGO

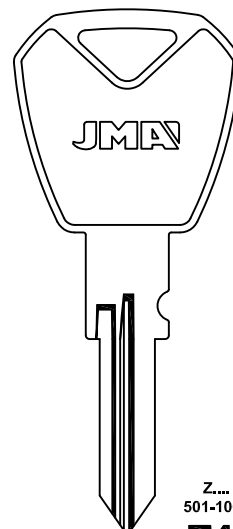

YUGO ZASTAVA

Z....
501-1000
 YU-1D

YWS

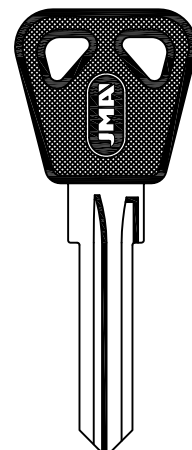

YW-1.P

ABUS

ZADI

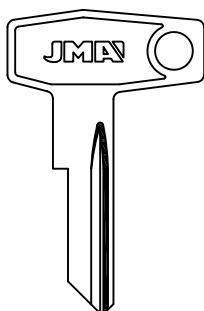

....1-1625
....5001-6278
E...1-710



ZA-1

BRETER

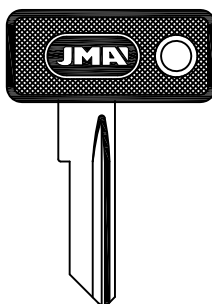

....1-1625
....5001-6278
E...1-710



ZA-1.P

BRETER

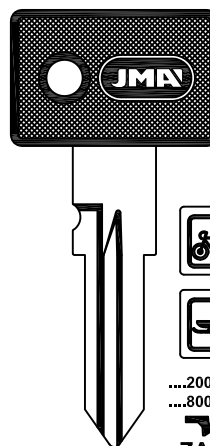

....2001-3554
....8001-9554



ZA-2.P



...1-700
....8001-9554
ZA-4D.P

APRILIA-GILERA-PIAGGIO VESPA
BASTA-VIRO

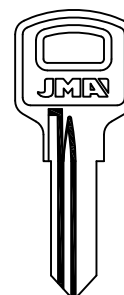

...1-390



ZA-3D



ZADI

PARA-FOR:

ZADI (I)

ZIL (RUS)

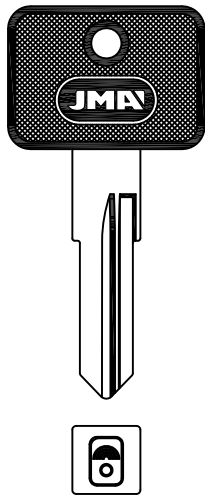

ZA-5.P ZA-5D.P

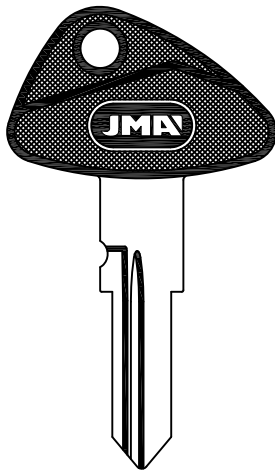

8001-9554
ZA-6D.P
BMW

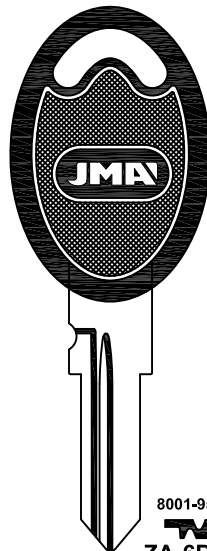

8001-9554
ZA-6D.P1
APRILIA-BETA

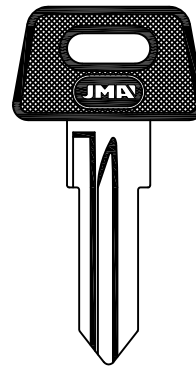

8001-9554
ZA-7D.P
GILERA-PIAGGIO

ZADI



ZA-8.P

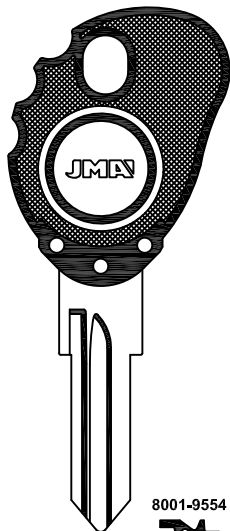

8001-9554
ZA-9.P
MALAGUTI-MBK

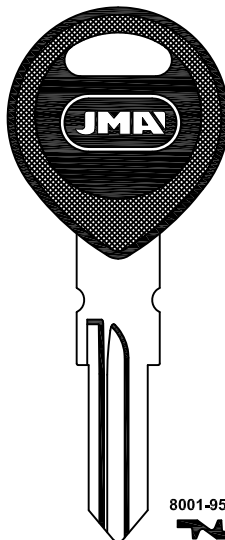

8001-9554
ZA-9.P1
PIAGGIO-MBK-YAMAHA

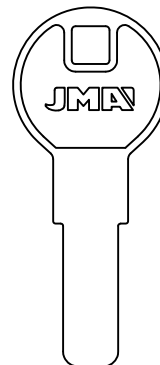

LAT.

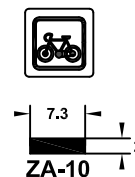

ZA-10

ZADI

ZIL

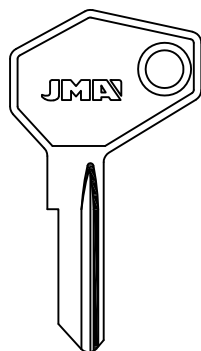

....1-1625
....5001-6278
E...1-710

ZA-12

BRETER

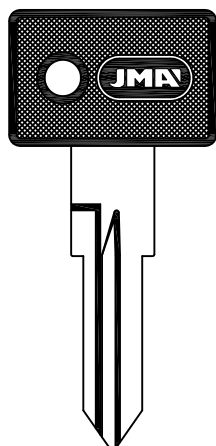

....5001-6475
ZA-13.P

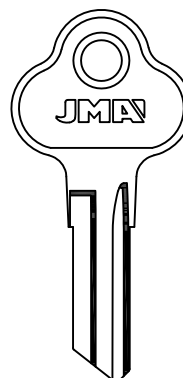

ZI-1



LLAVES DE CIERRE

*IXTEKO GILTZAK
SNAP-LOCK KEYS
CLES DE BOUCHE D'EAU
DORNSCHLÜSSEL*



Tél. 04 73 84 84 94
info@palserviceminute.com



THE KEY TO EXCELLENCE
GLOBALLY UNLOCKING MILLIONS OF DOORS DAILY

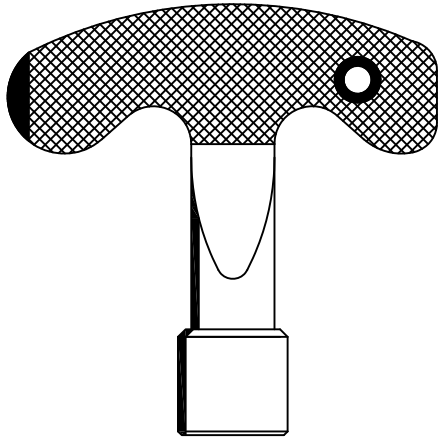

ZAM.

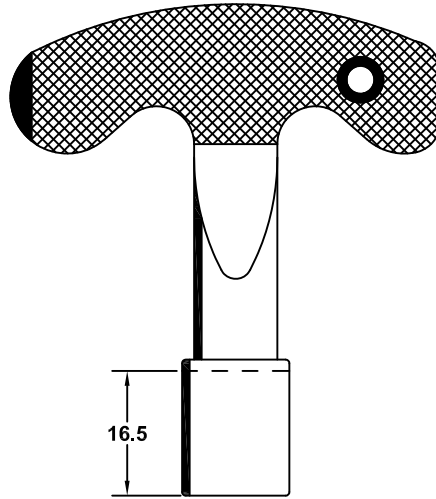

ZAM.



6
500



7
501



8
502



10
503



6
504



8
505



10
506



8.5
507



8
508

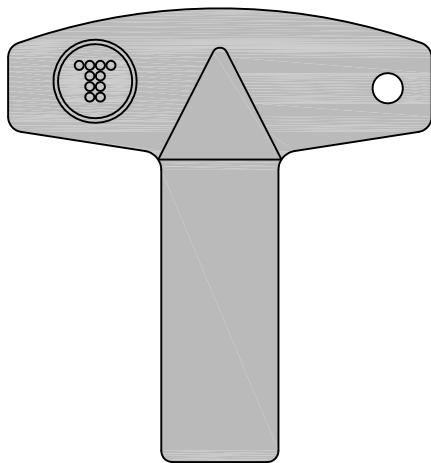

PLAS.

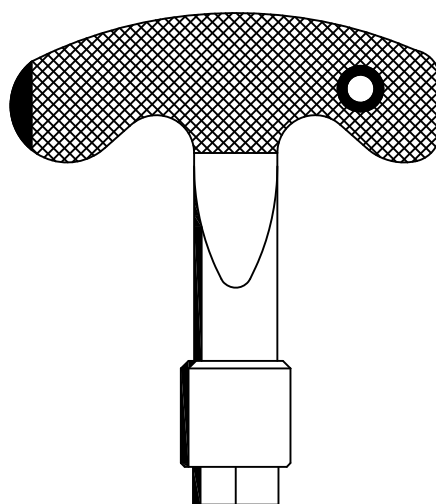

ZAM.

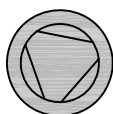

9.5
509



8
510



PARA-FOR:

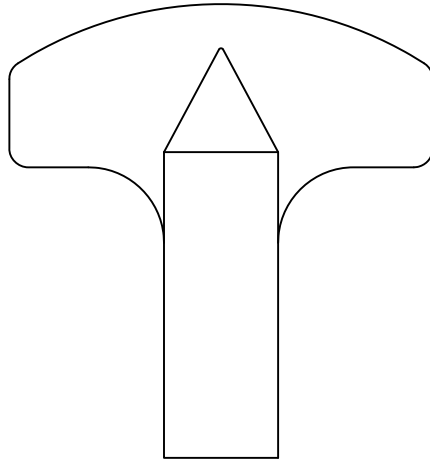

ALU.

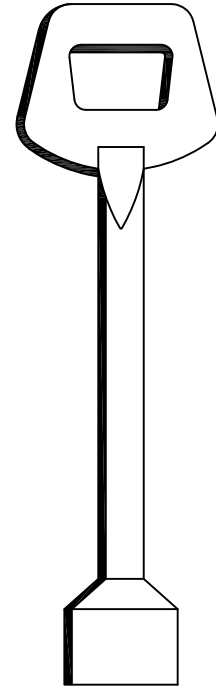

ZAM.



8.5
511



10
512

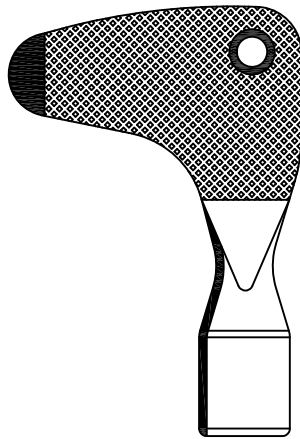

LAT.



8.5
513
ORONA



LLAVES EN CRUZ

*GURUTZE-GILTZAK
CRUCIFORM KEYS
CLES CRUCIFORMES
KREUTZSCHLÜSSEL*



THE KEY TO EXCELLENCE
GLOBALLY UNLOCKING MILLIONS OF DOORS DAILY

PARA-FOR:







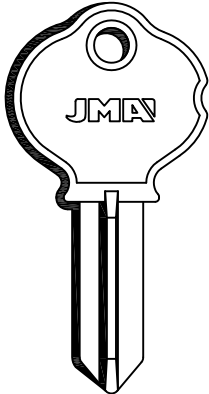
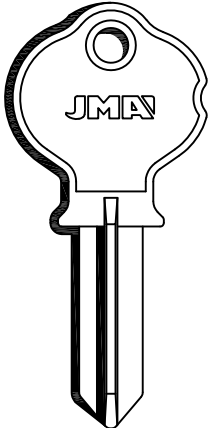
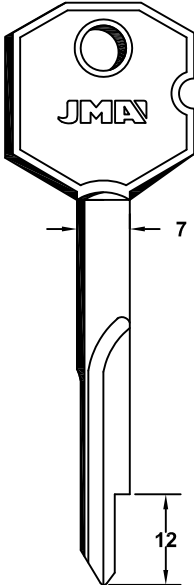
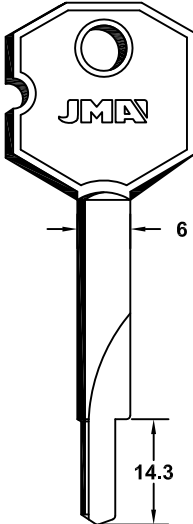

AGC (P)

ALA (I)

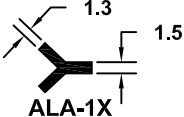
BLUMA (D)

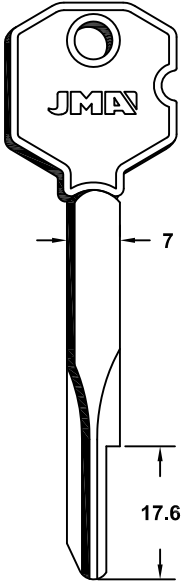
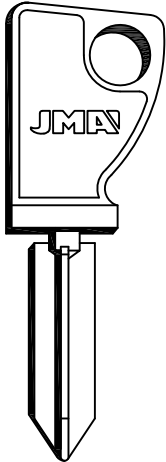
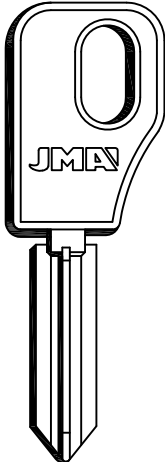
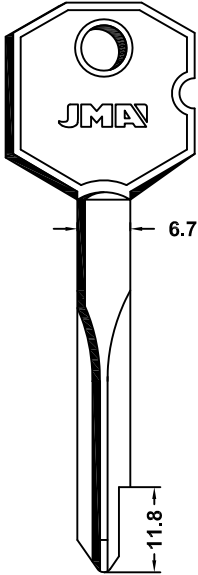
BRICARD (F)

BURG (D)

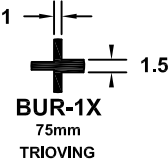
AGC		ALA	BLUMA
			
 AGD-1X CCF3	 AGD-2X CCF3	 ALA-1X	 BLU-1X
BLUMA	BRICARD		BURG
			
 BLU-2X	 BRI-1X	 BRI-2X	 BRI-3X
			 BUR-1X 75mm TRIOVING



BURG

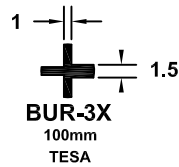
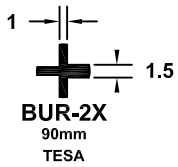
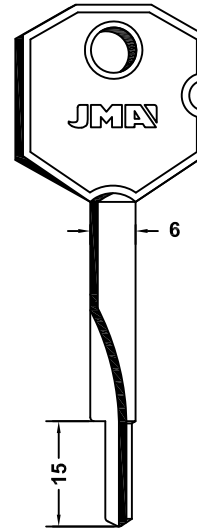
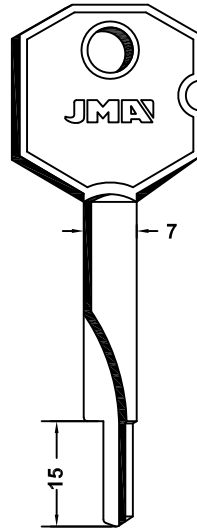
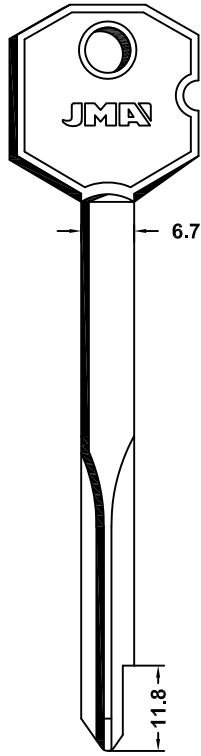
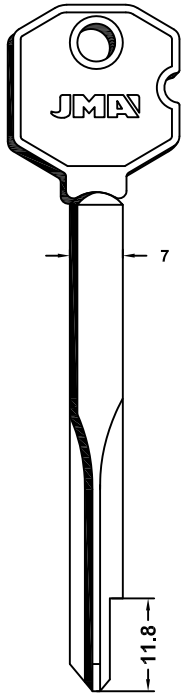

PARA-FOR:

BURG (D)



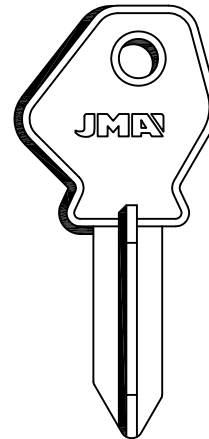
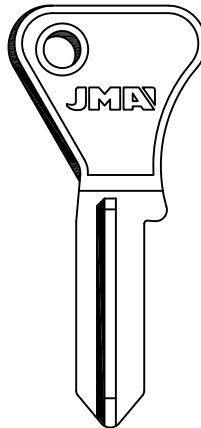
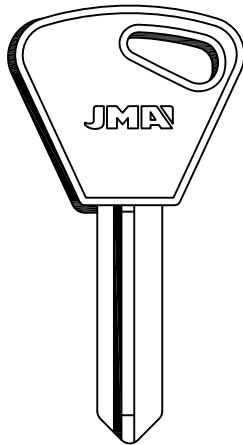
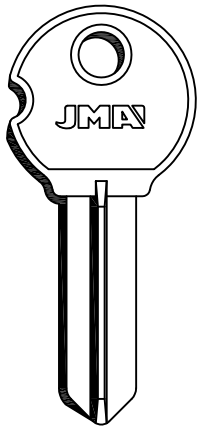

CCF (P)

CCF

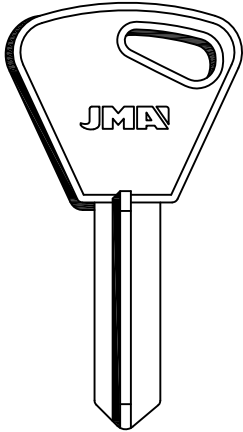
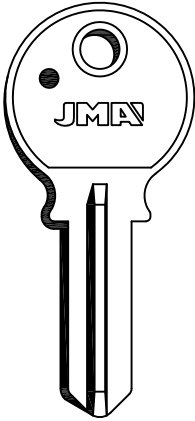
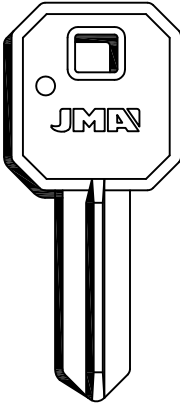
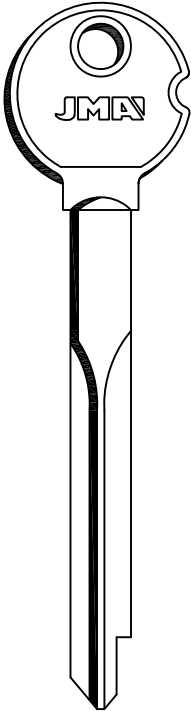

PARA-FOR:

- CCF (P)
- CIFIAL (P)
- CRC CAMBOA (P)
- DEBEAURAIN (F)
- DOOR LOCK
- FAYN (TR)
- FIAM (I)

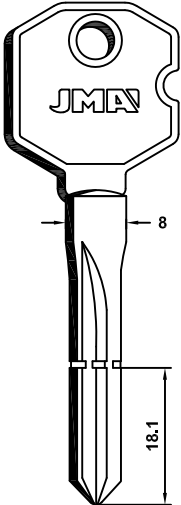
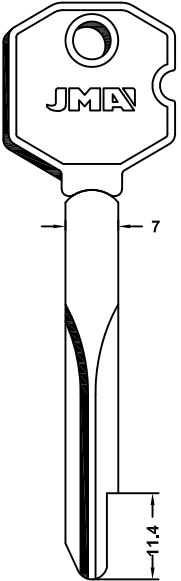
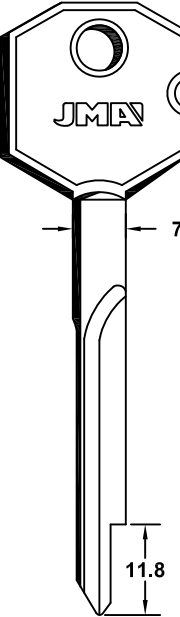
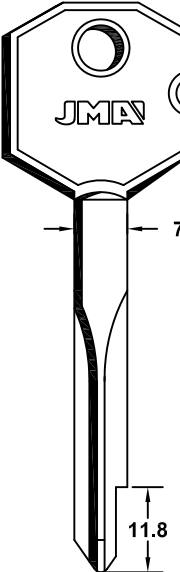
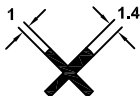
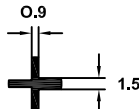
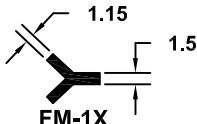
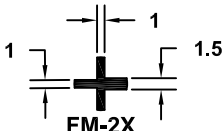
	CCF	CIFIAL	CRC CAMBOA	DEBEAURAIN
				
	 CCF-10X	 CIF-1X CCF4	 CRC-1X	 DEB-1X
DOOR LOCK	FAYN	FIAM		
				
 DOL-1X	 FAY-1X	 FM-1X	 FM-2X	



FRIPA

GERA

PARA-FOR:

- FRIPA (D)
- GERA (D)
- HELCO KFV (D)
- ISEO (I)

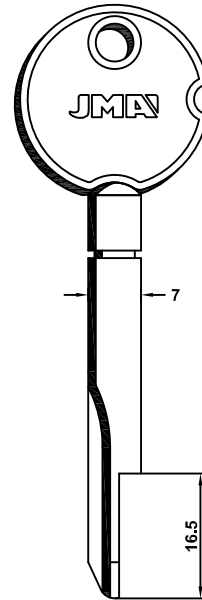
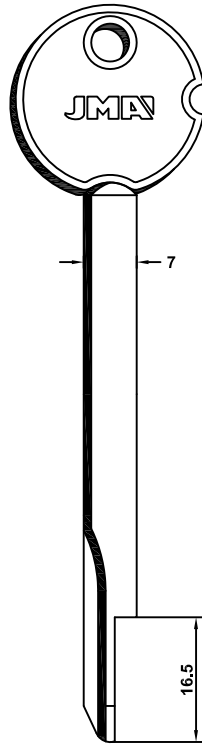
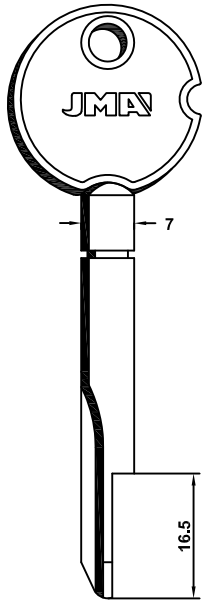
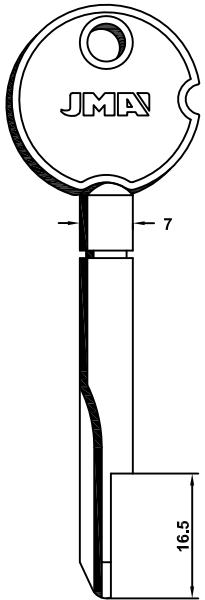

FRI-1X

GERA



FRI-2X

GERA

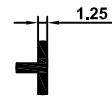

GEA-1X

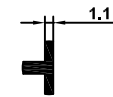

GEA-3X

HELCO KFV

ISEO

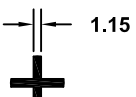
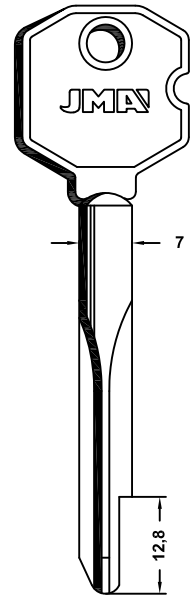
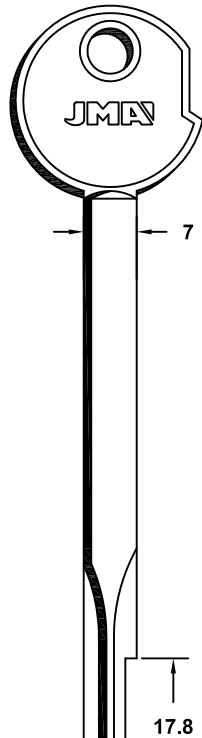
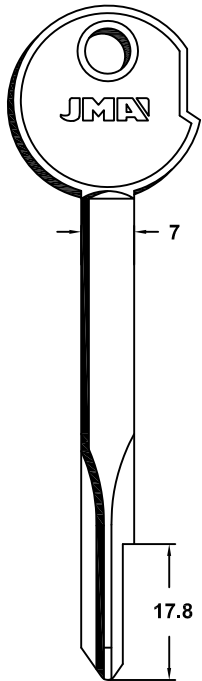
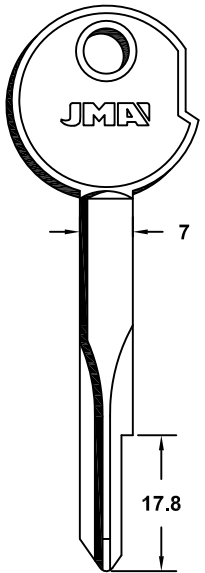

KFV-1X
75mm

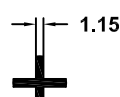

KFV-2X
85mm

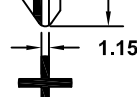

KFV-3X
100mm

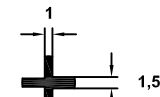

IS-1X



PARA-FOR:
KRESTI (RUS)

KRESTI

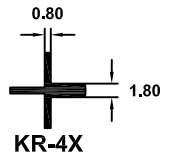
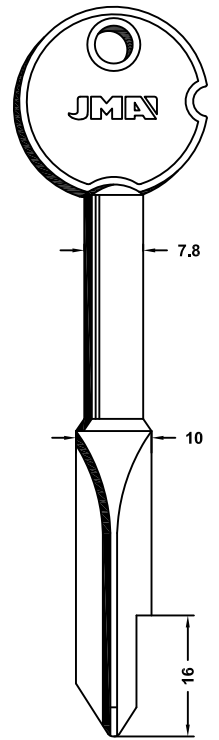
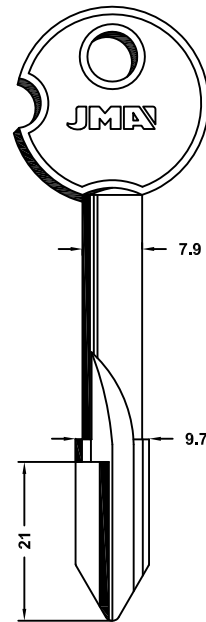
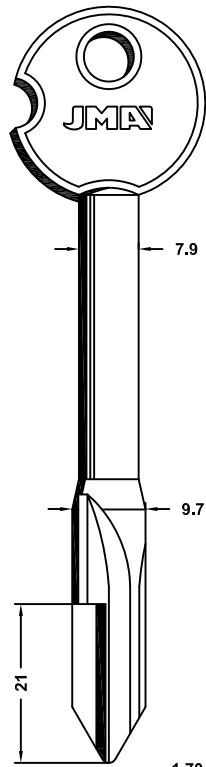
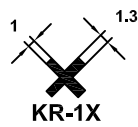
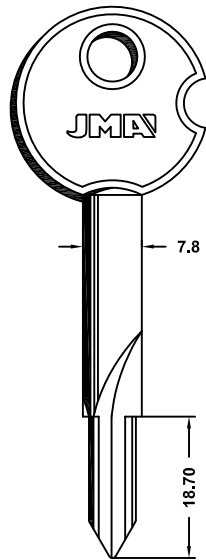

KRESTI

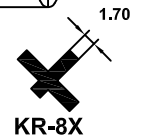
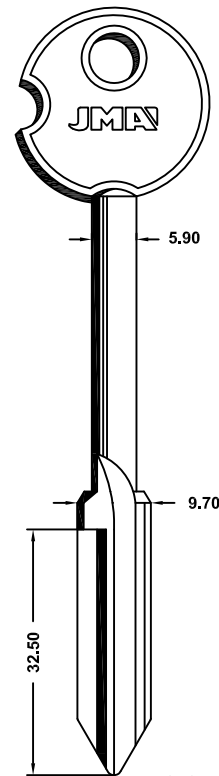
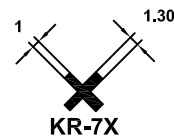
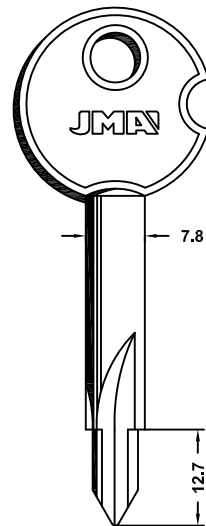
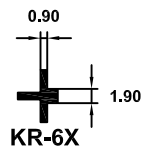
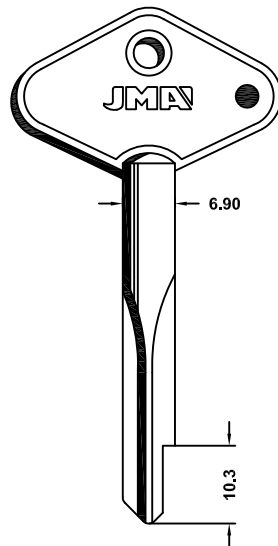
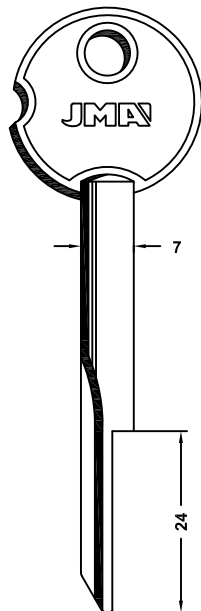

KRESTI

PARA-FOR:
KRESTI (RUS)

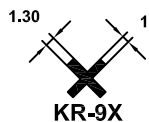
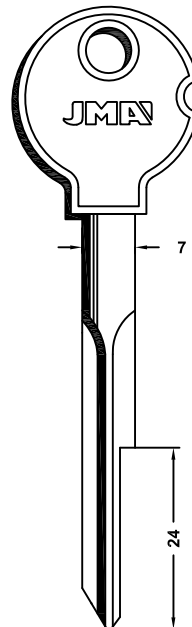
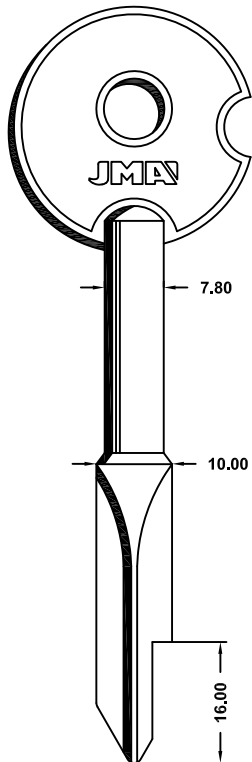
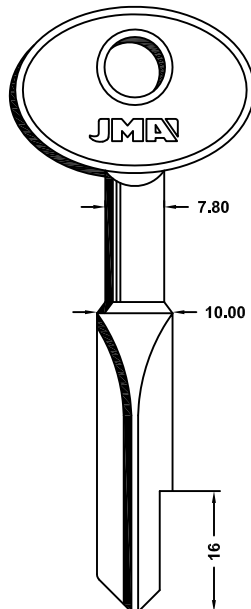
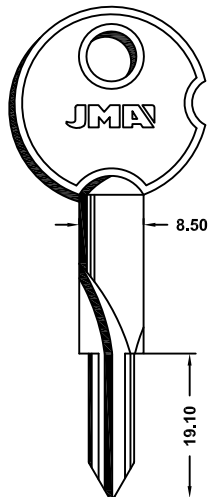

KR-9X

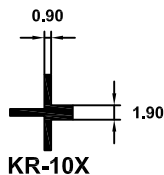

KR-10X

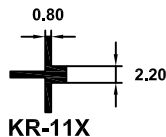

KR-11X

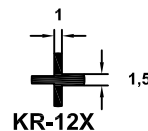

KR-12X

KRESTI

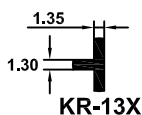
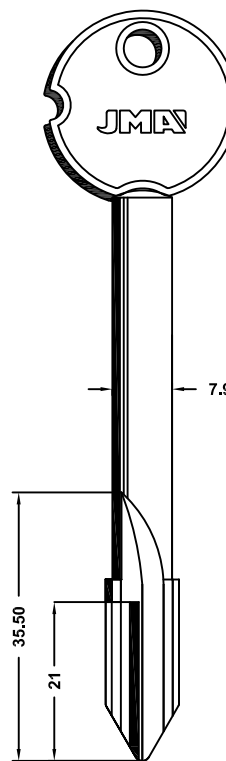
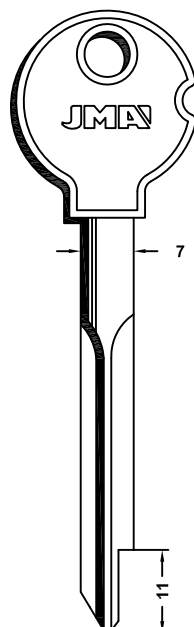
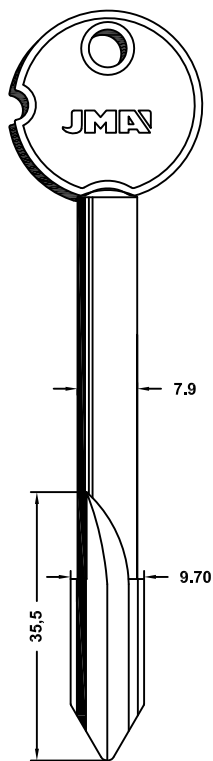
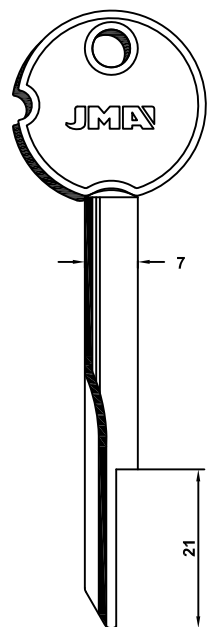

KR-13X

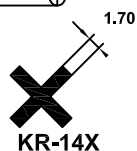

KR-14X

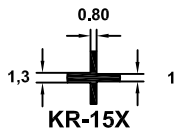

KR-15X

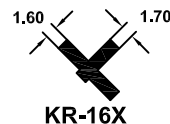

KR-16X



PARA-FOR:

KRESTI (RUS)

LOCK-IT (GB)

MAFOR (F)

MINI MOLA (P)

MOREAUX (F)

MSV (P)

NABOB (IL)

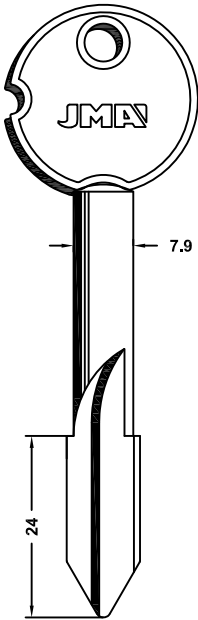
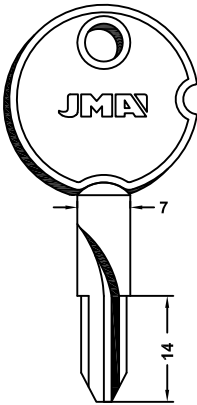
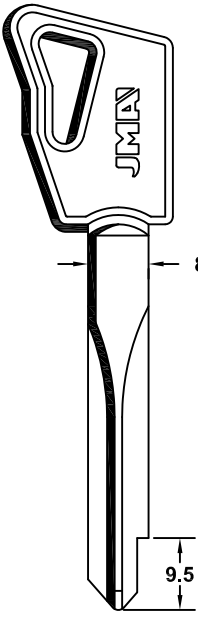
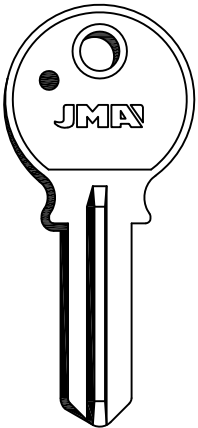
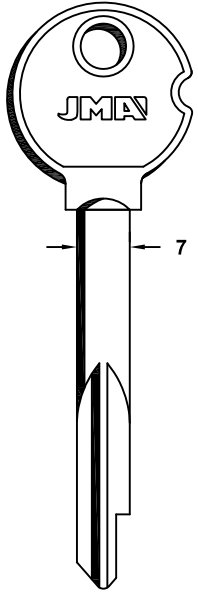
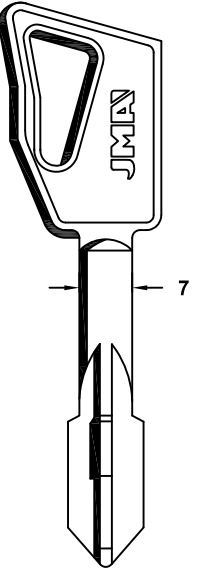
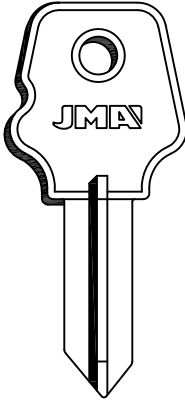
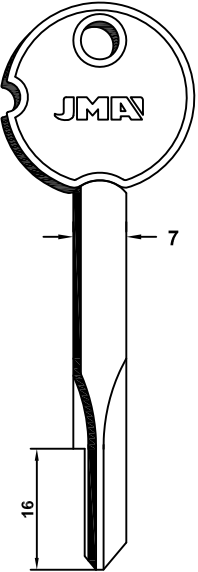
KRESTI	LOCK-IT	MAFOR	MINI MOLA
 <p style="text-align: center;">KR-17X</p>	 <p style="text-align: center;">LCK-1X</p>	 <p style="text-align: center;">RO-1X RONIS-SOS</p>	 <p style="text-align: center;">MM-1X CCF7 ANA</p>
MOREAUX		MSV	NABOB
 <p style="text-align: center;">MOR-1X</p>	 <p style="text-align: center;">MOR-2X</p>	 <p style="text-align: center;">MSV-1X</p>	 <p style="text-align: center;">NAB-1X</p>



NEMEF

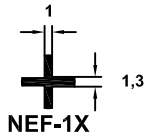
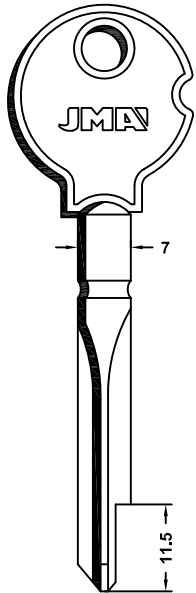

PAPAIZ

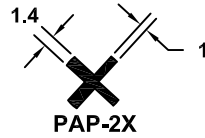
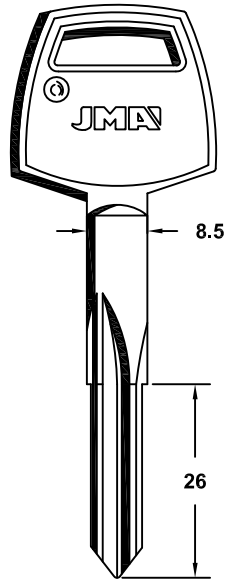
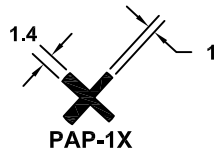
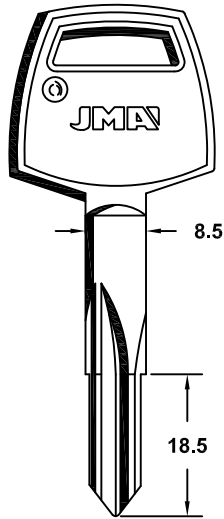

TUFF

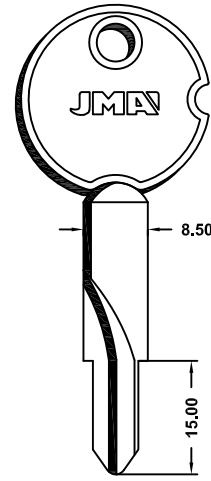

PARA-FOR:

- NEMEF (D)
- PAPAIZ (BR)
- TUFF (HK)
- UNIVERSAL
- YALE BKS (I-D)

TUFF

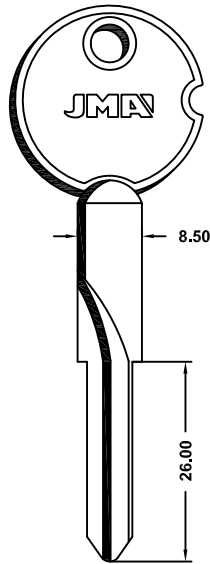
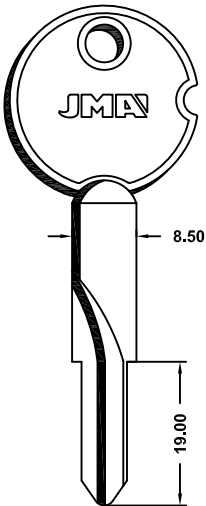

UNIVERSAL

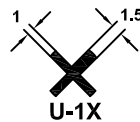
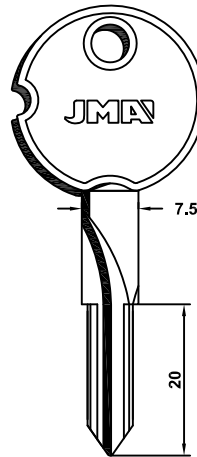

YALE BKS

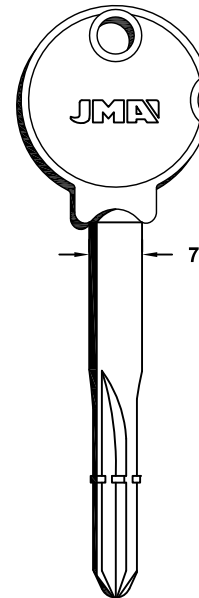

PARA-FOR:

YALE BKS (I-D)

ZEISS IKON (D)

YALE BKS

YALE

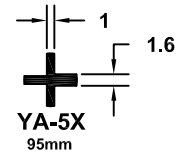
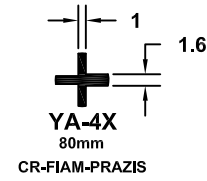
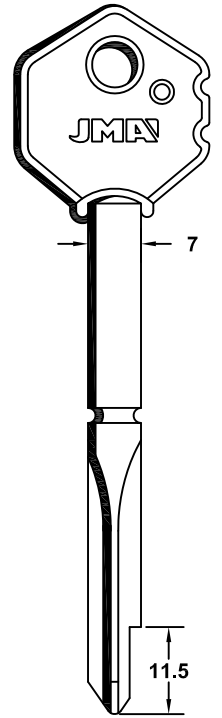
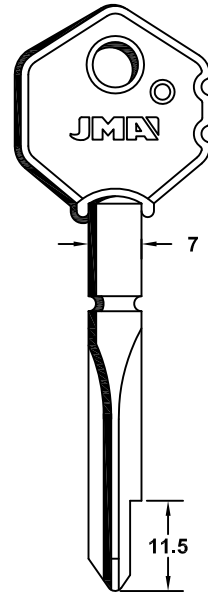
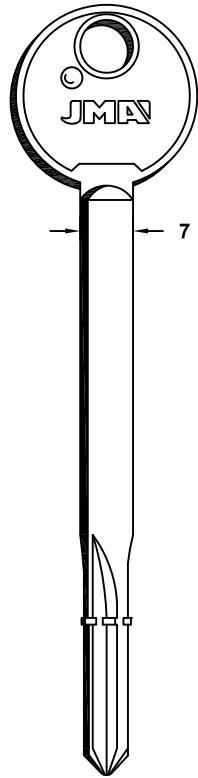
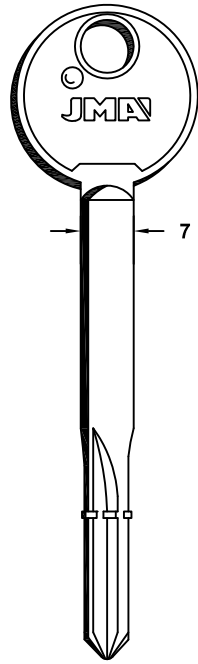

CR-FIAM-PRAZIS

YALE

ZEISS IKON

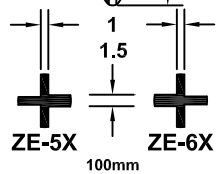
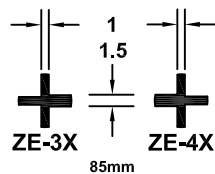
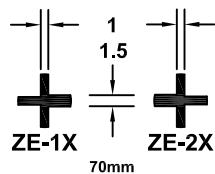
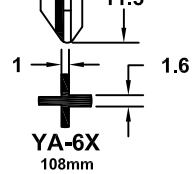
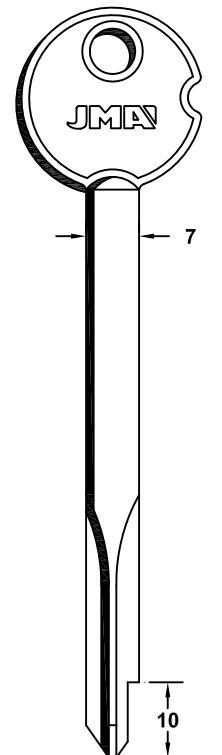
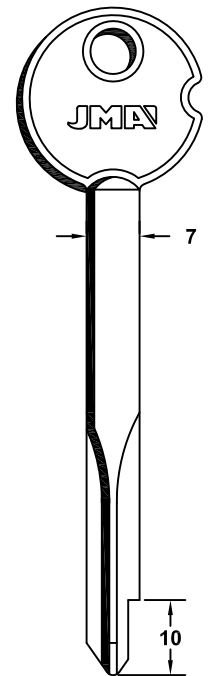
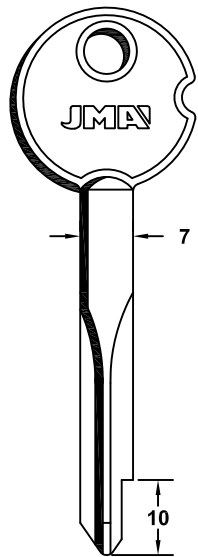
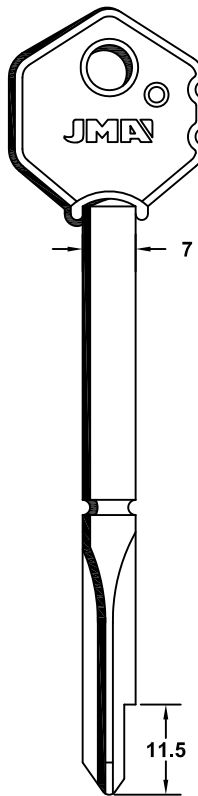

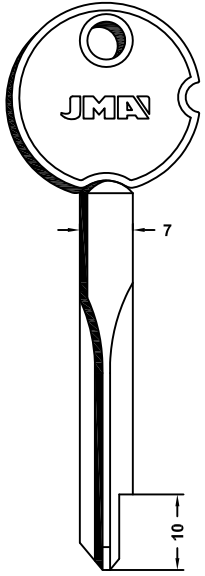

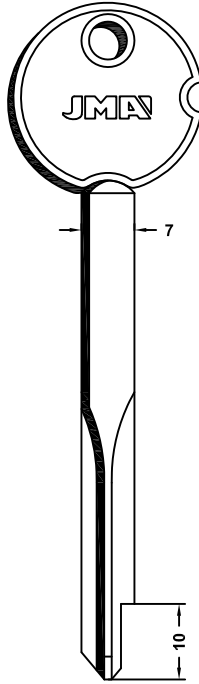

ZE-7X
75mm

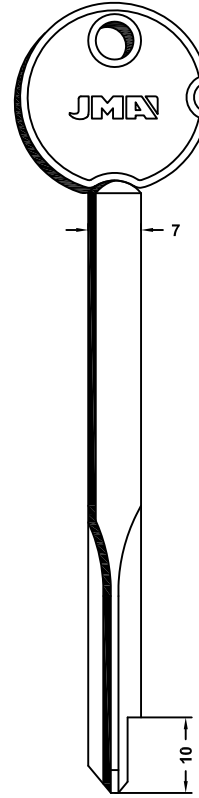

ZE-8X
90mm



ZE-9X
105mm



LLAVES DE GORJA ACERO DULCE

ALTZAIRU GOZOZKO GORJA-GILTZA

MILD STEEL BIT KEYS

CLES A GORGES EN ACIER DOUX

CHUBBSCHLÜSSEL AUS WEICHSTAHL

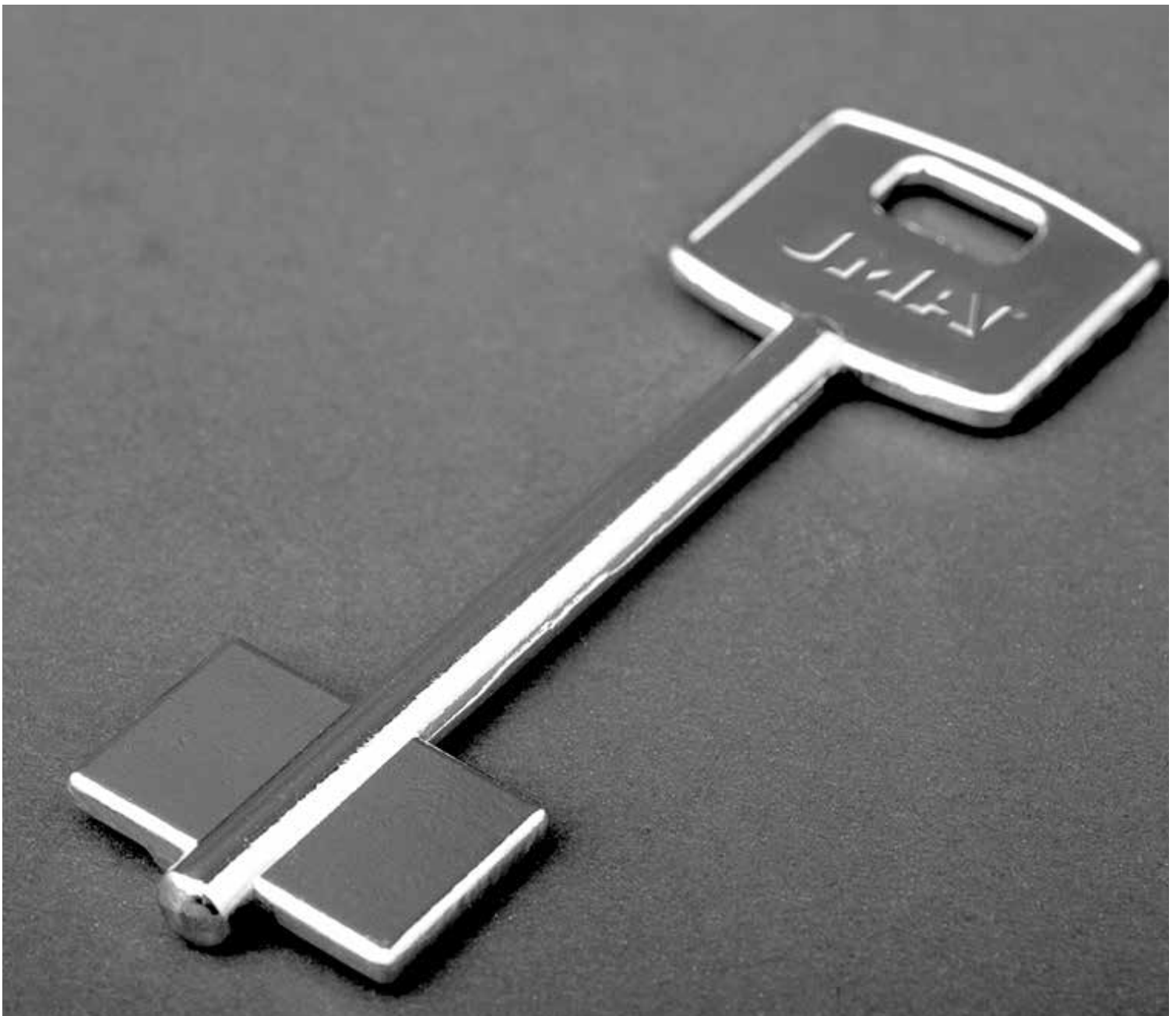

THE KEY TO EXCELLENCE
GLOBALLY UNLOCKING MILLIONS OF DOORS DAILY

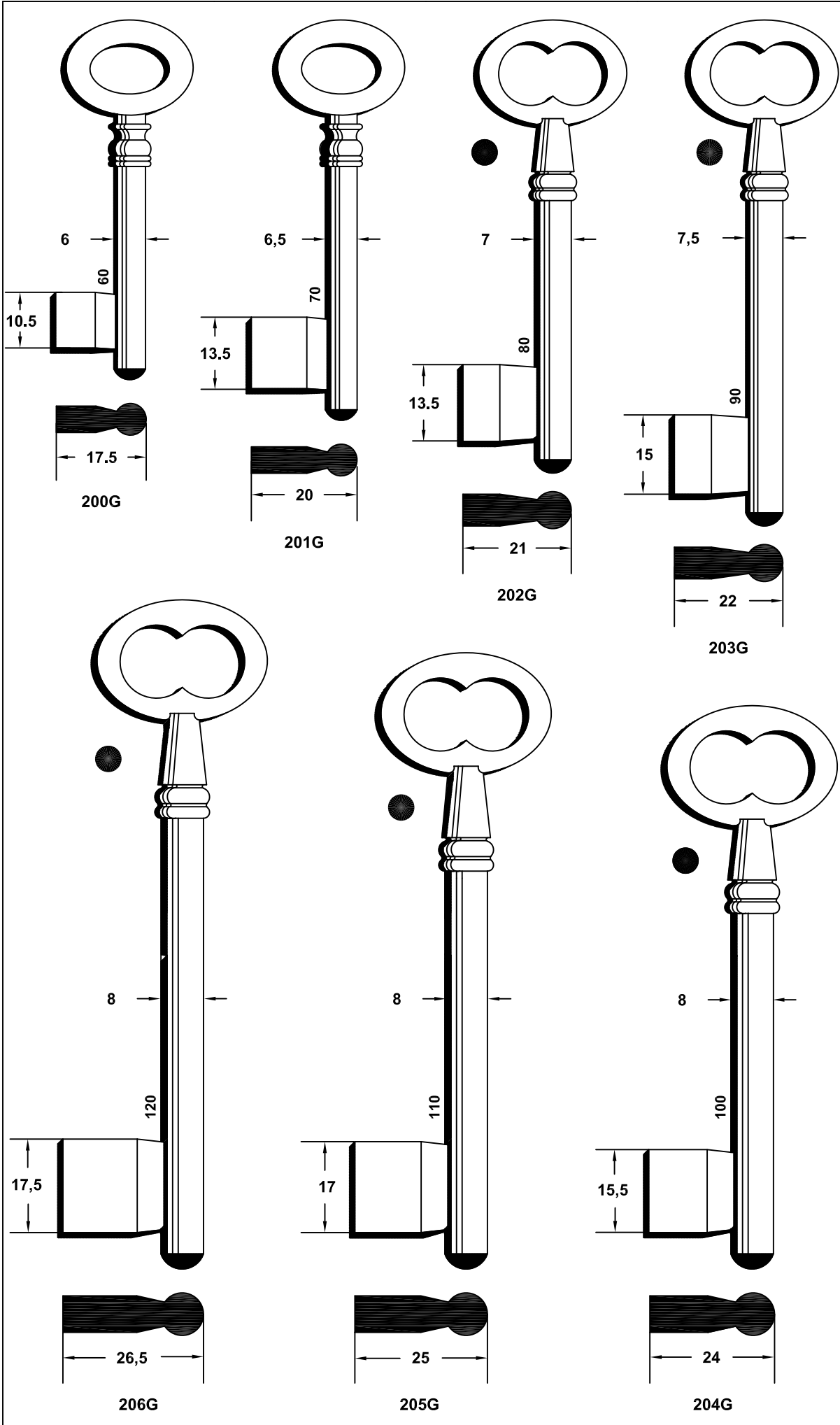

PARA-FOR:

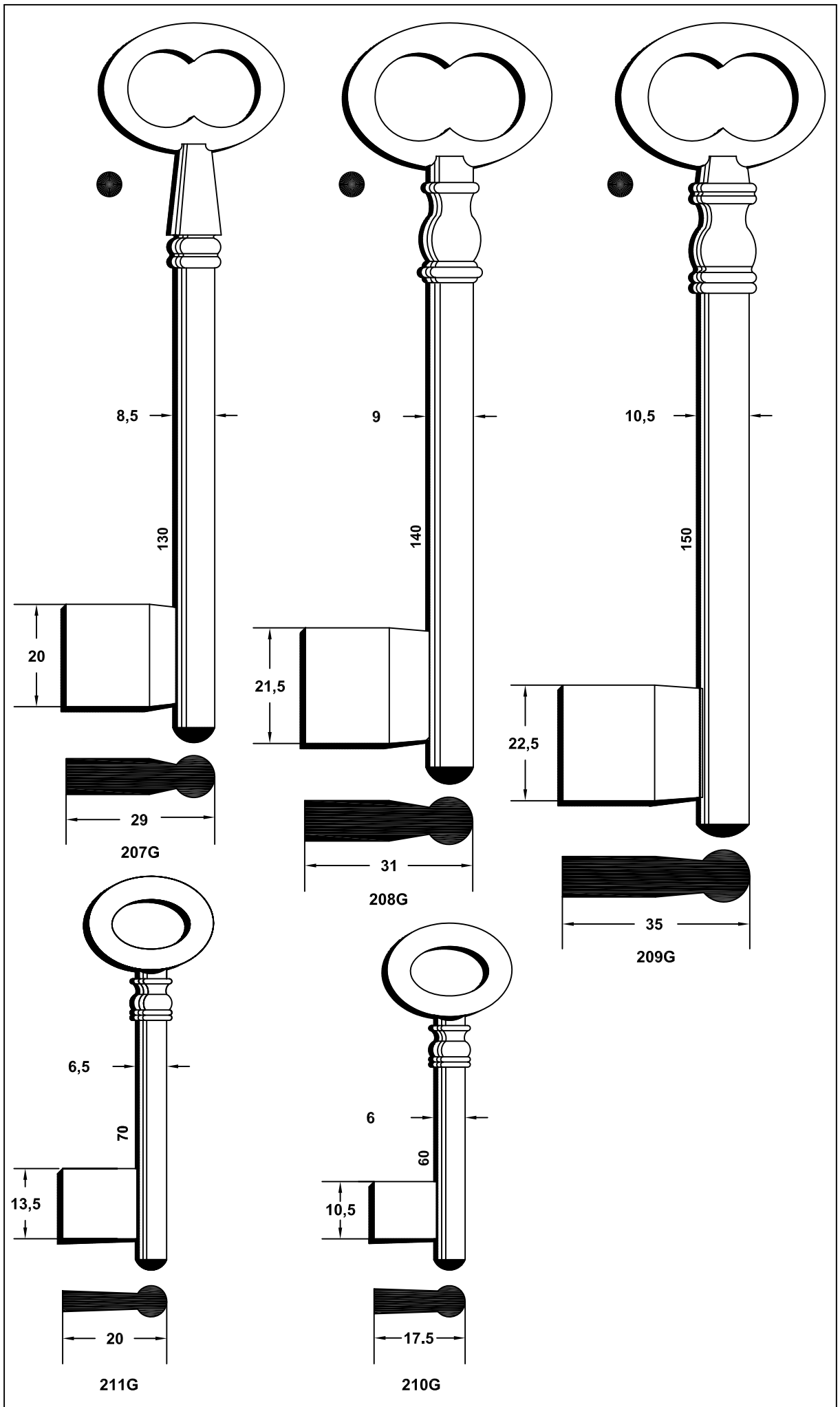

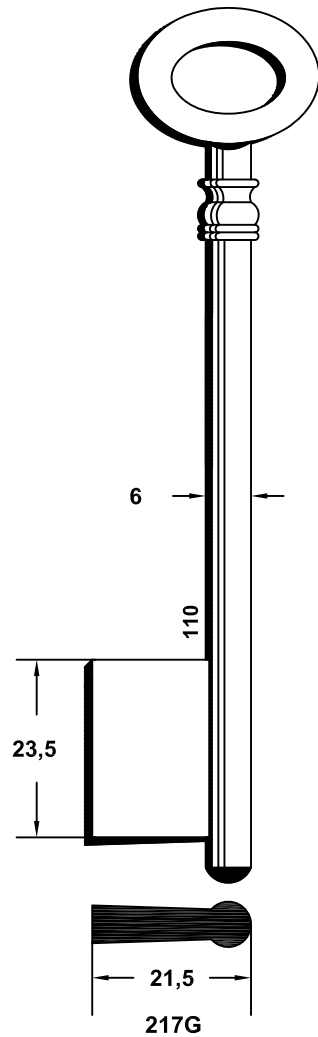
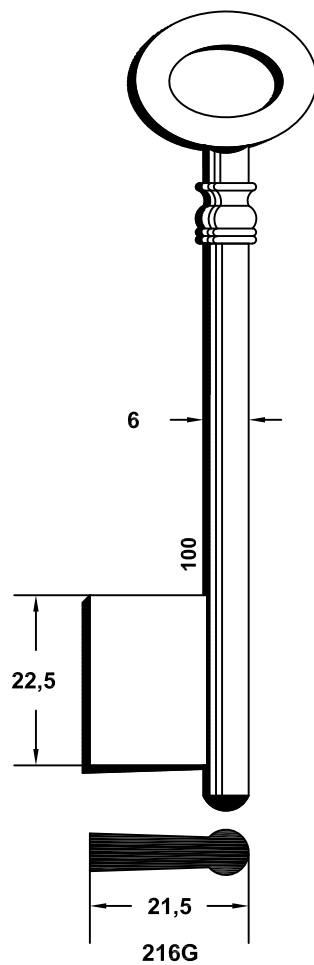
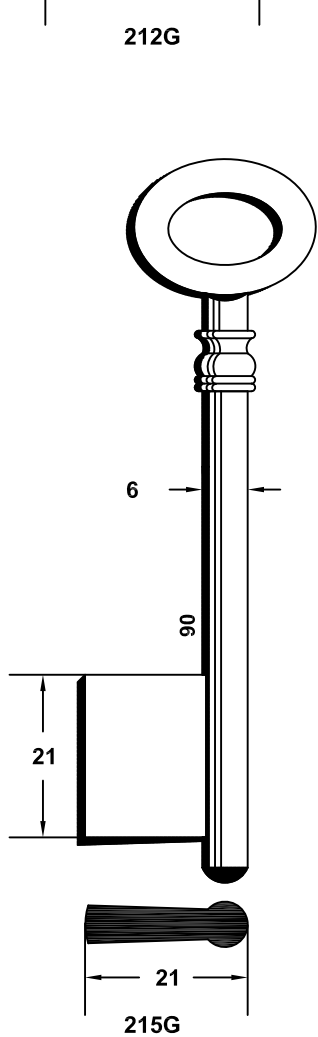
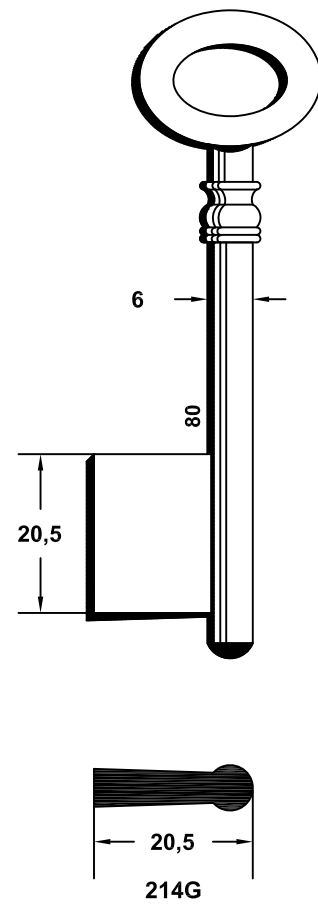
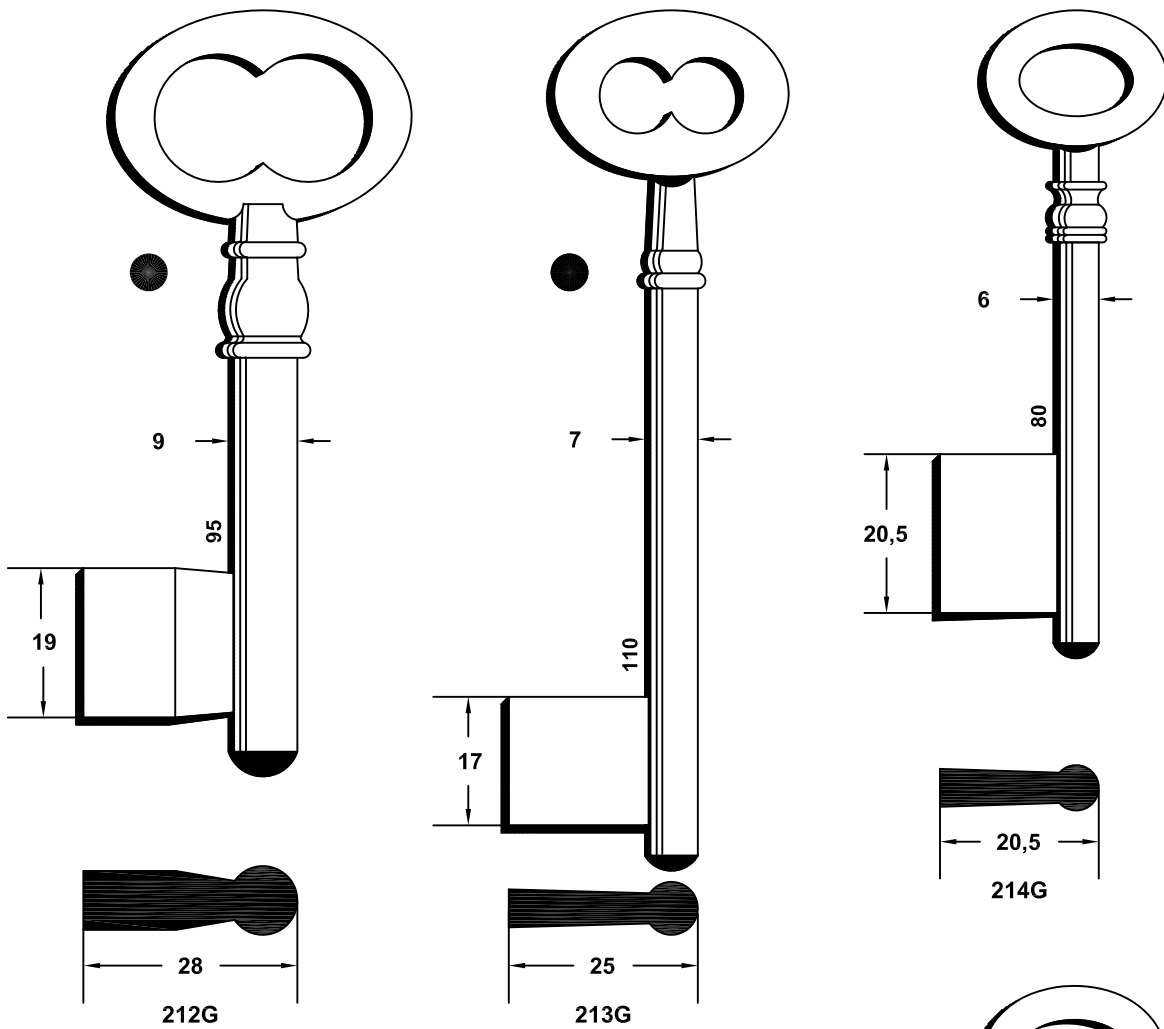

PARA-FOR:

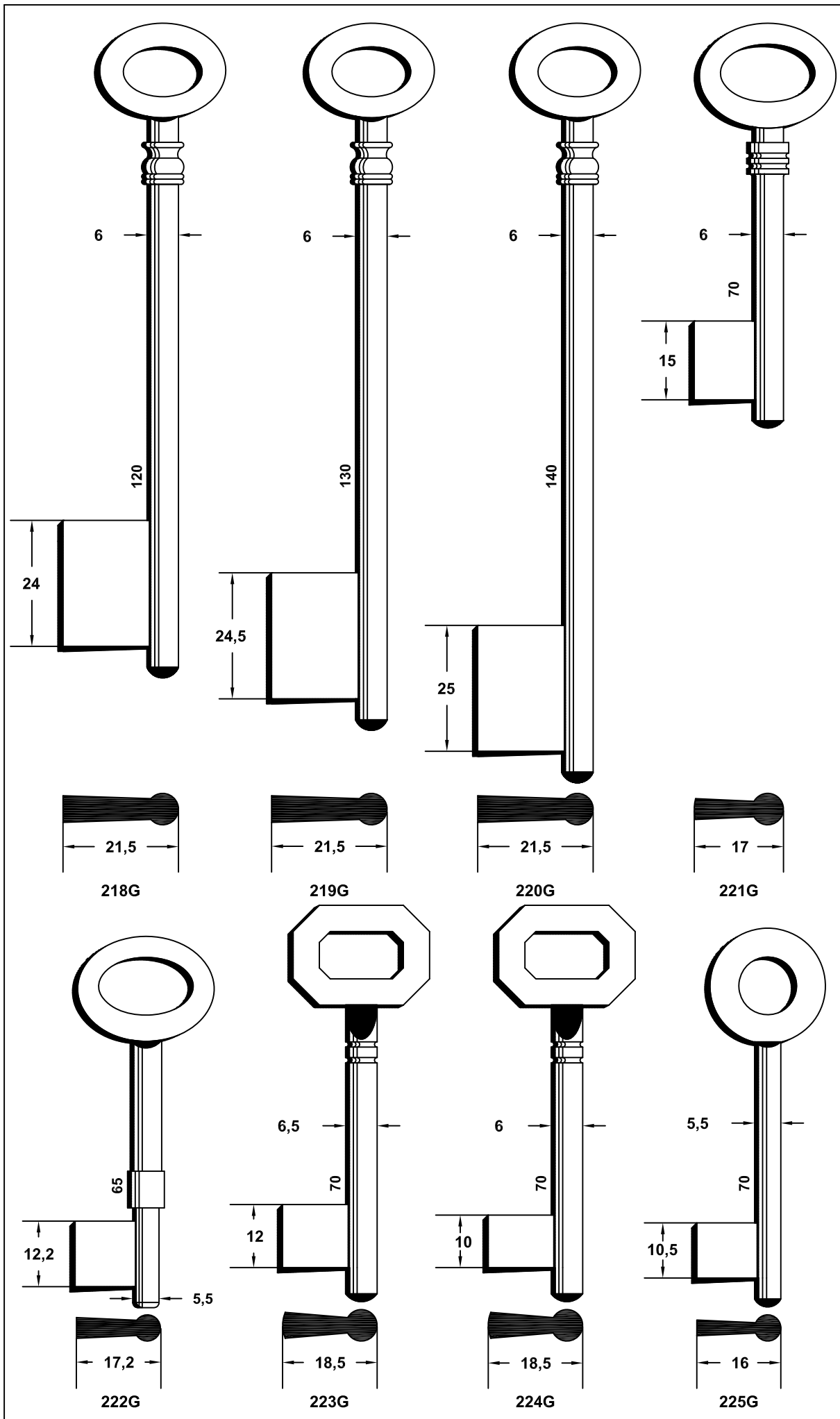

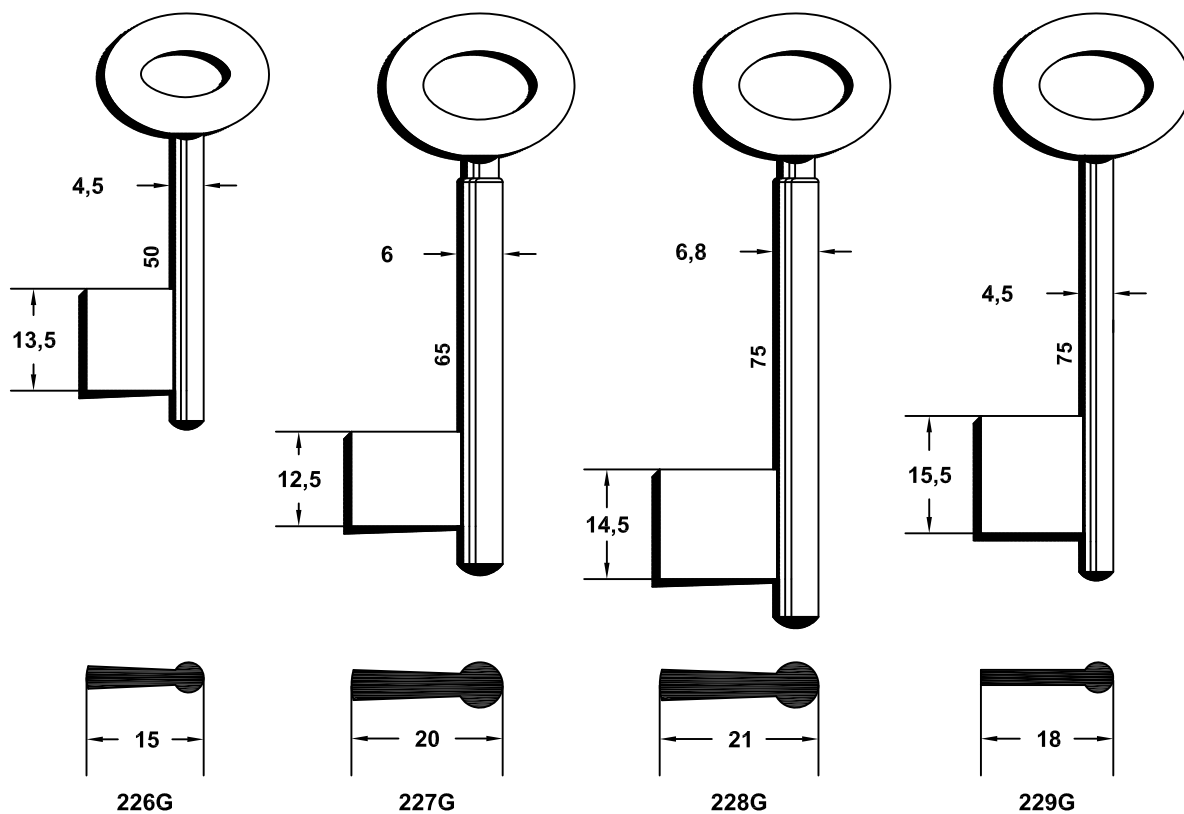

226G

227G

228G

229G

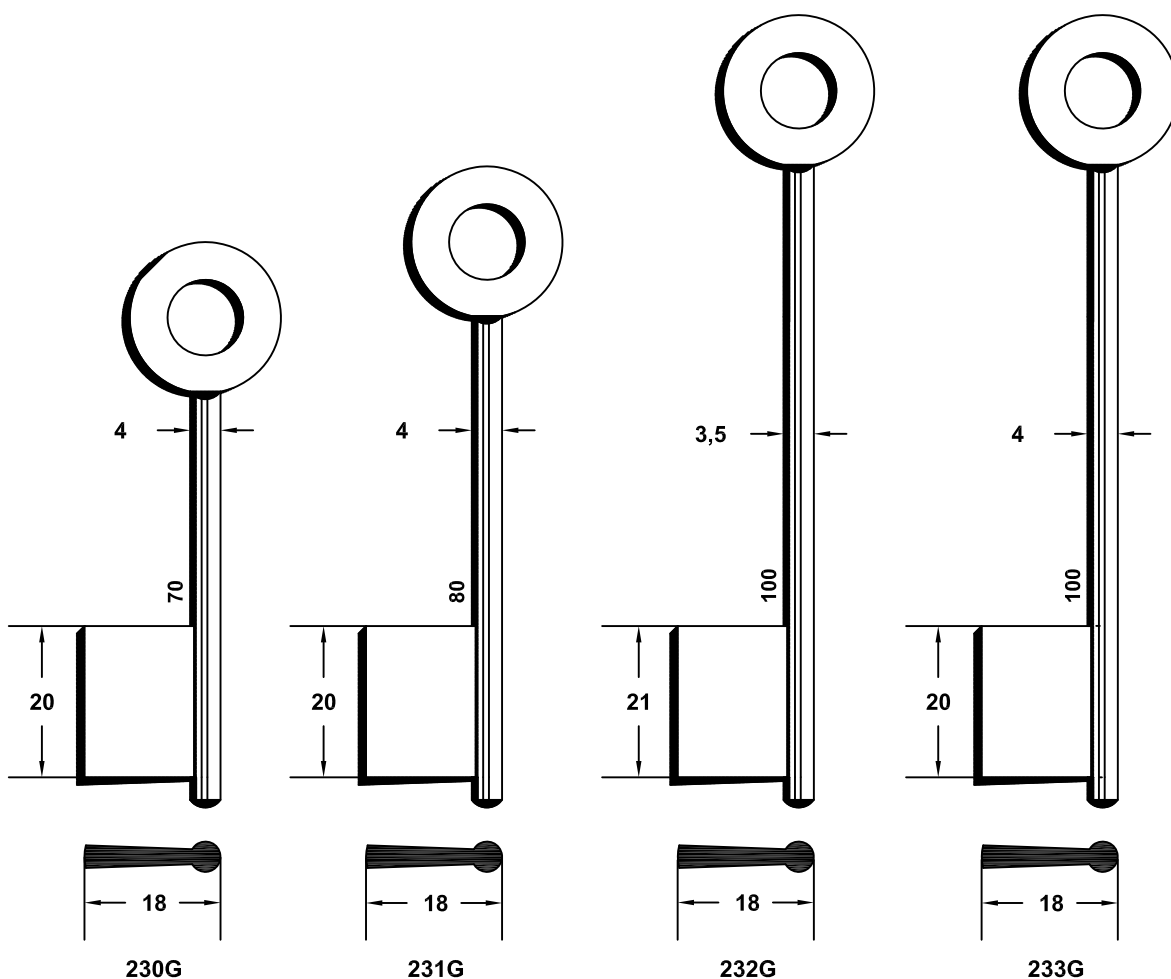

230G

231G

232G

233G



PARA-FOR:
BOINAITI (I)

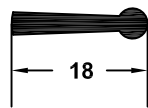
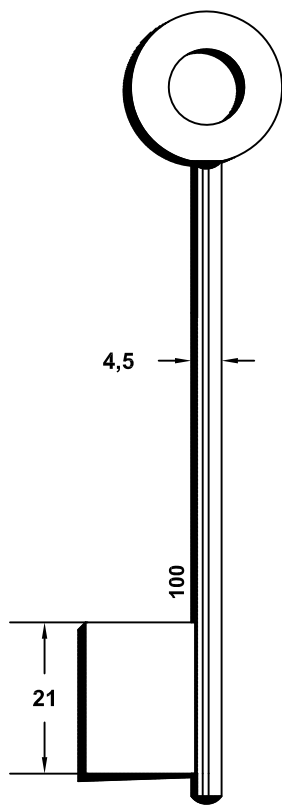

234G

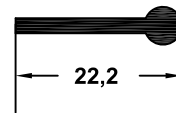
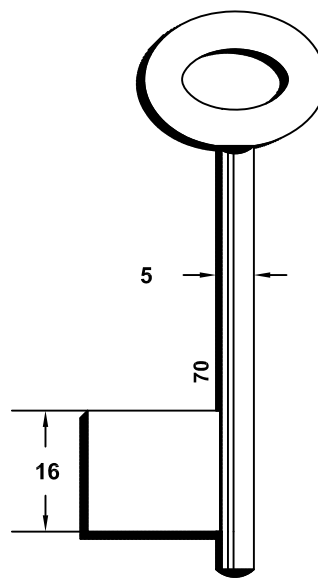

236G

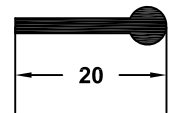
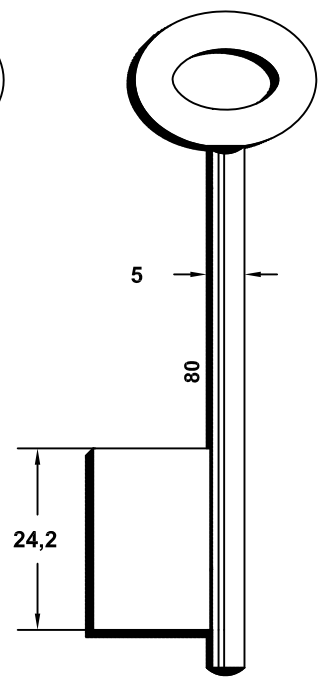

237G

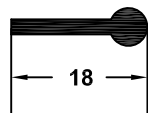
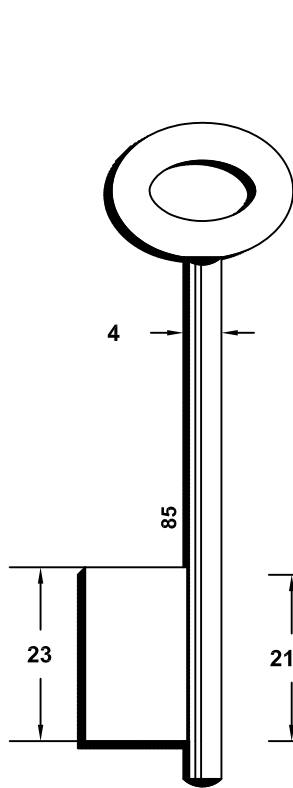

238G

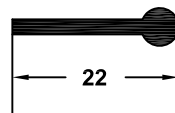
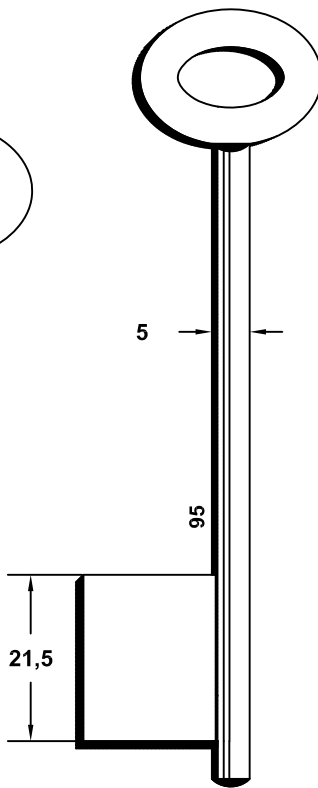

239G

BOINAITI

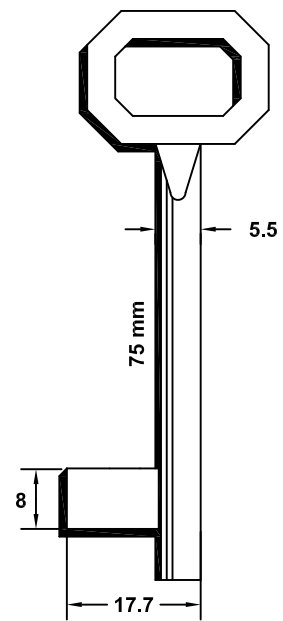

BON-3G



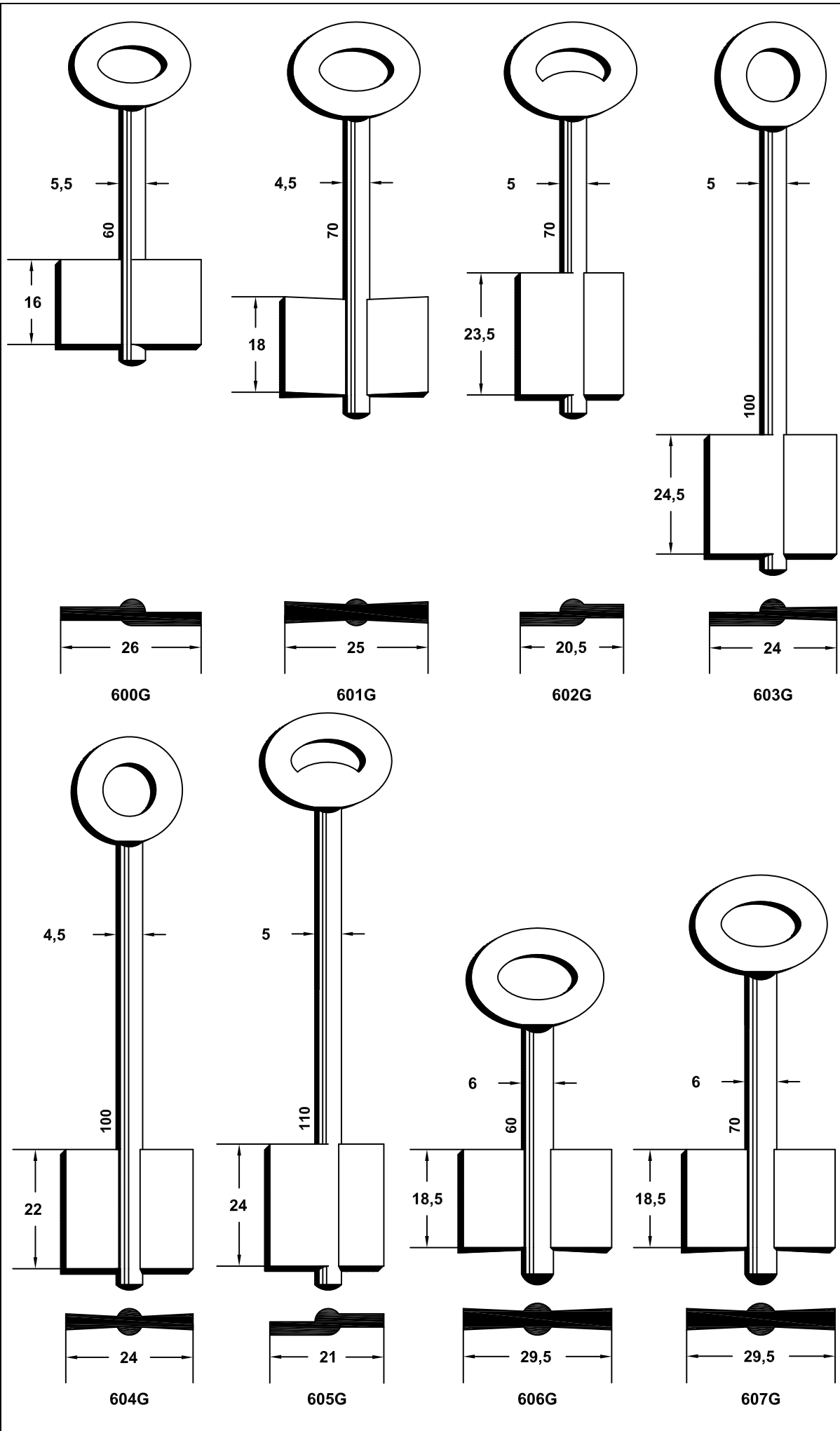

PARA-FOR:

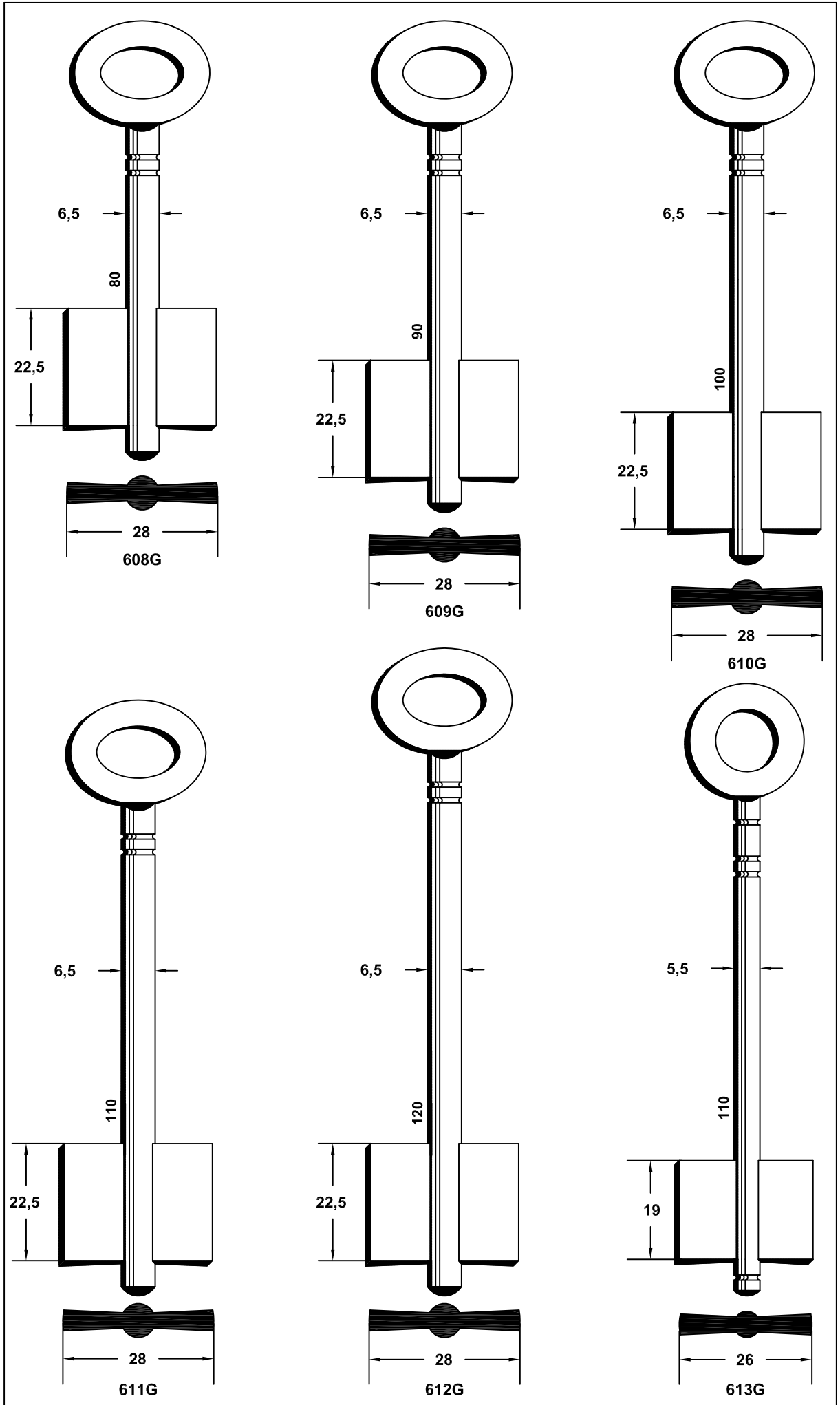

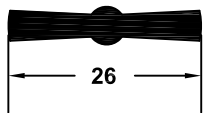
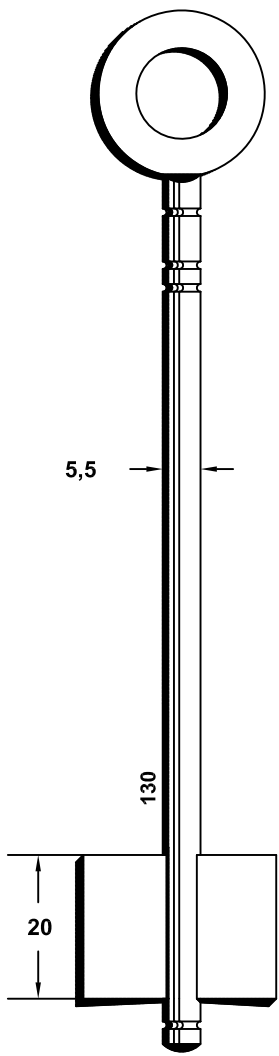

614G

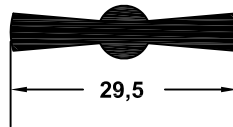
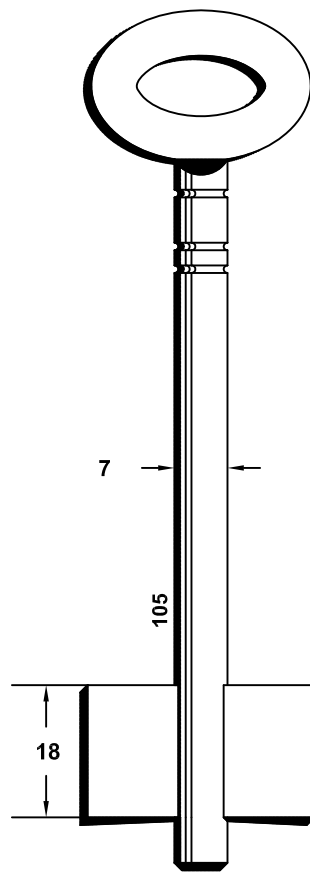

615G

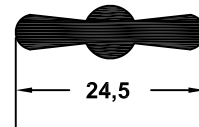
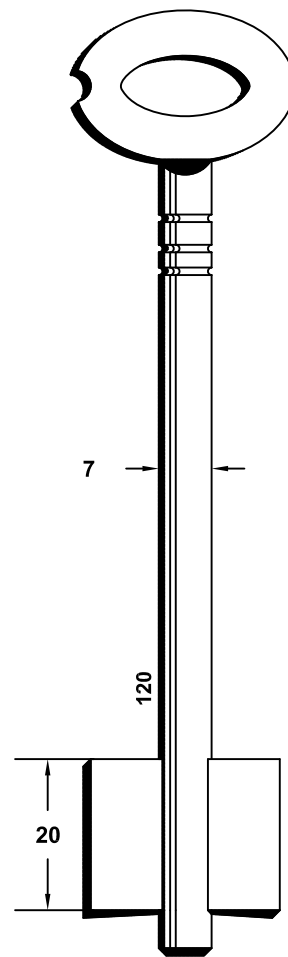

616G

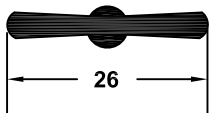
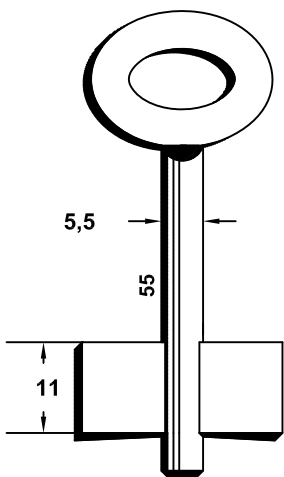

618G

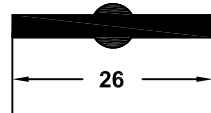
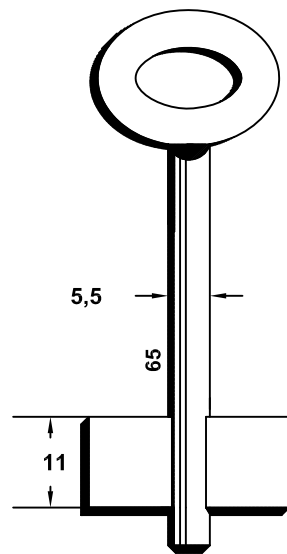

619G

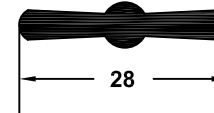
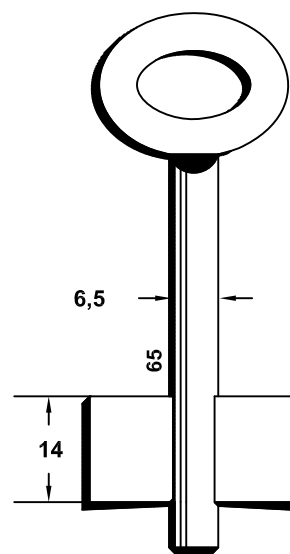

620G



PARA-FOR:

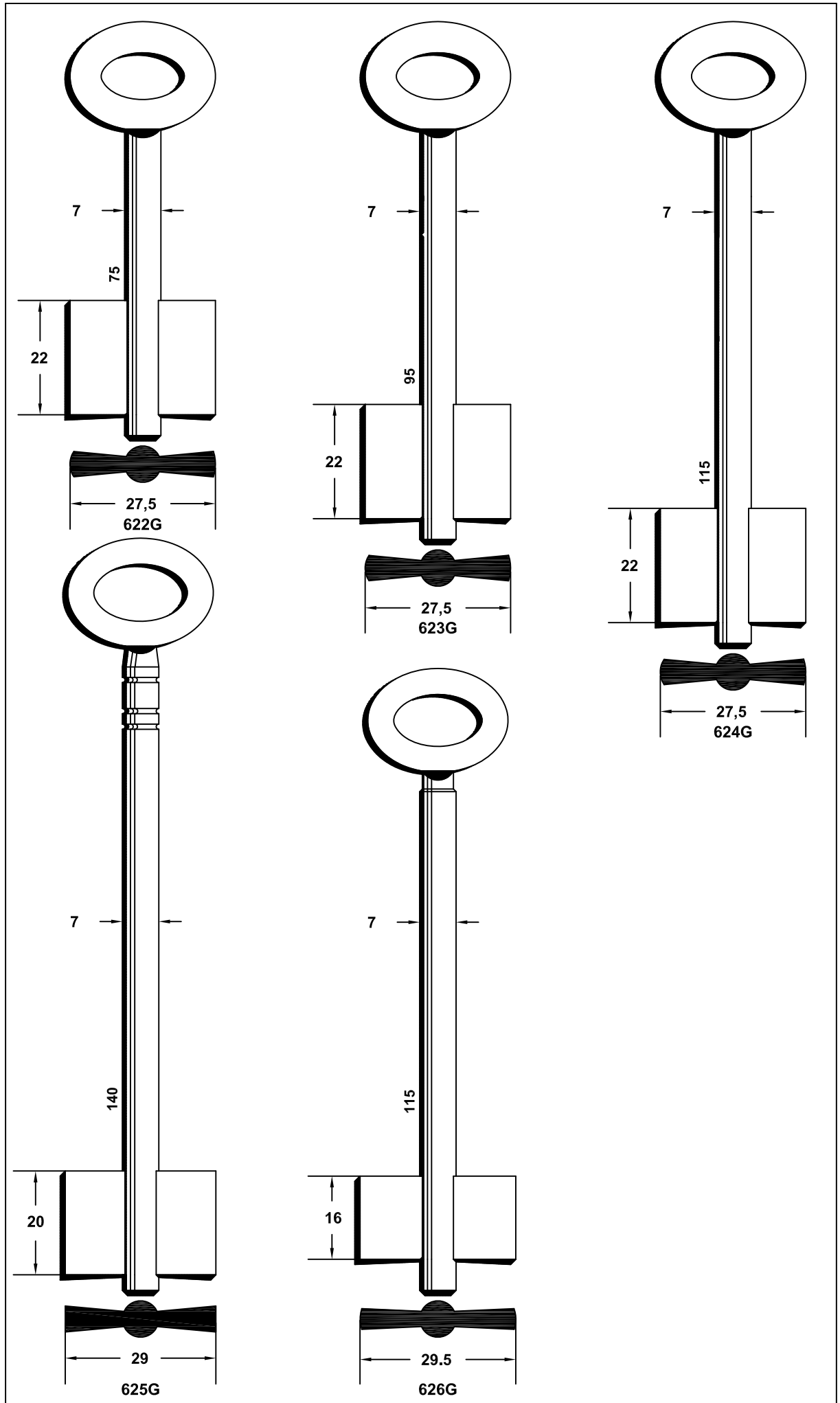

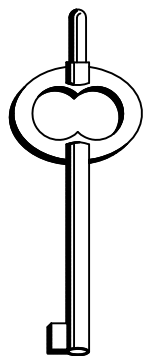

74G

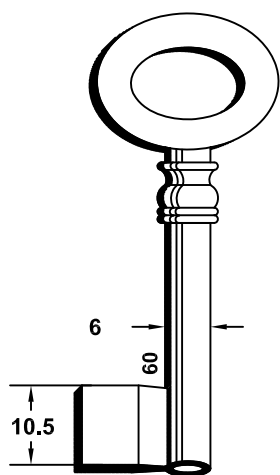

1200G

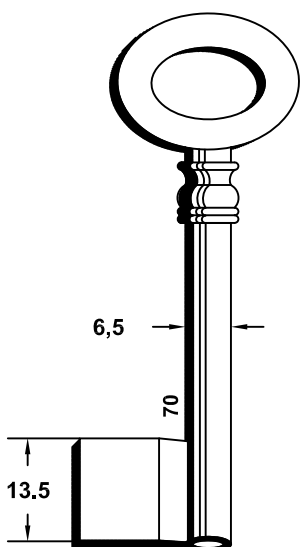

1201G

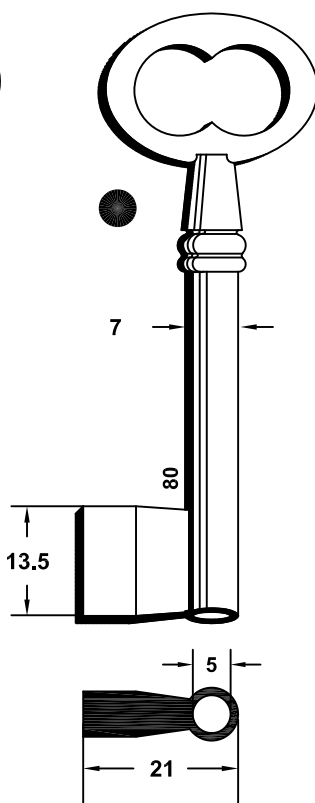

1202G

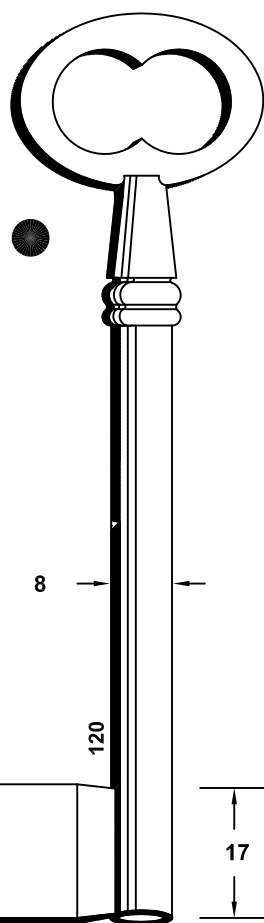

1206G

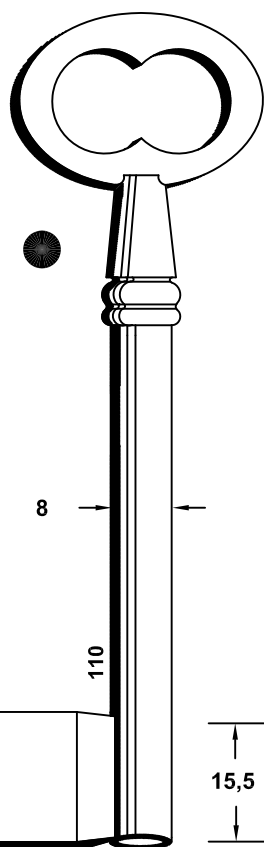

1205G

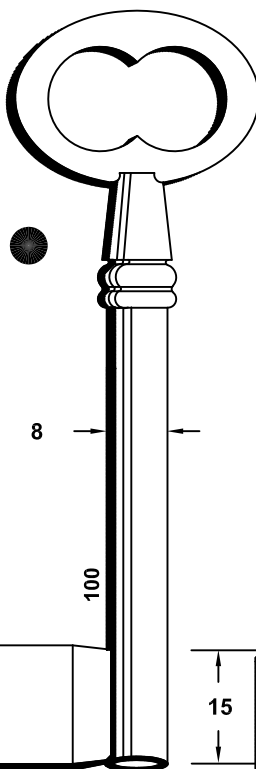

1204G

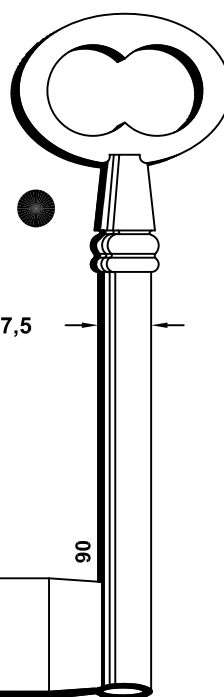

1203G

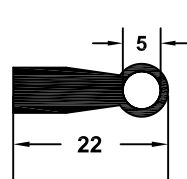
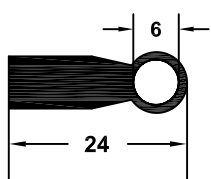
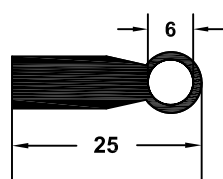
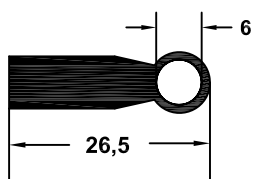

PARA-FOR:

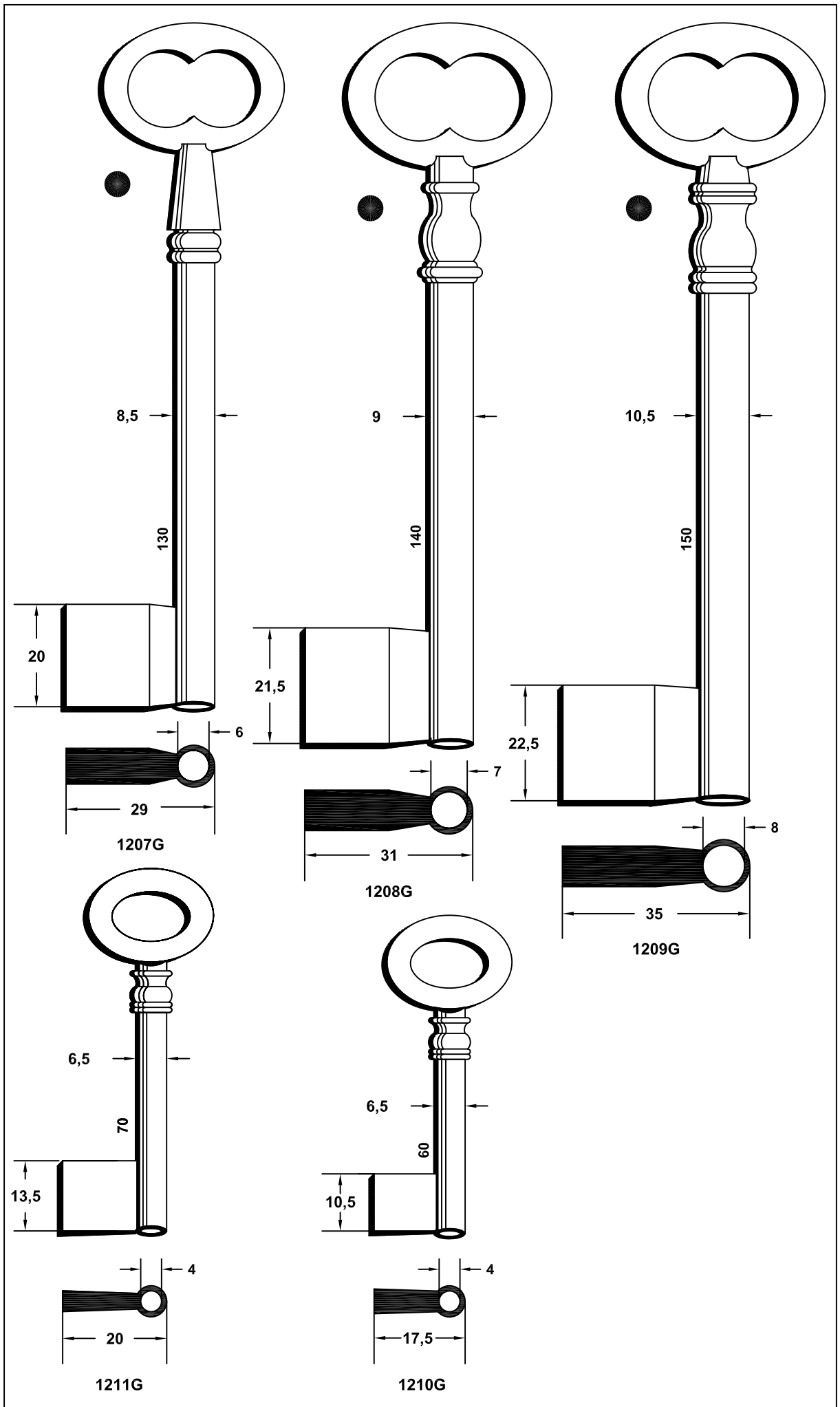

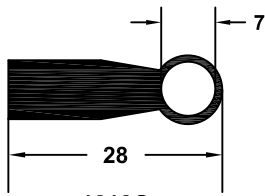
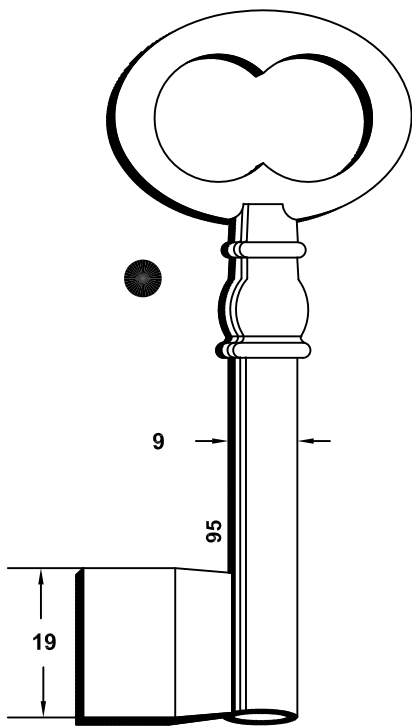

1212G

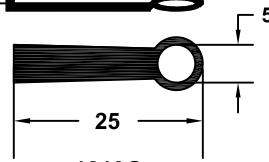
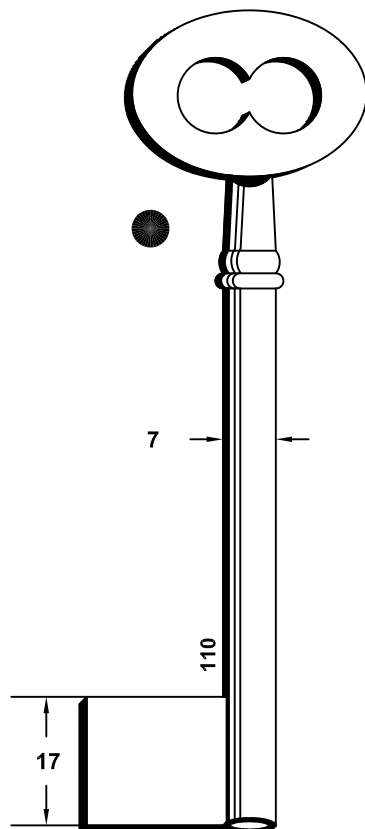

1213G

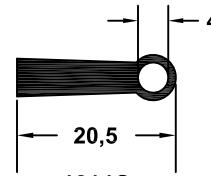
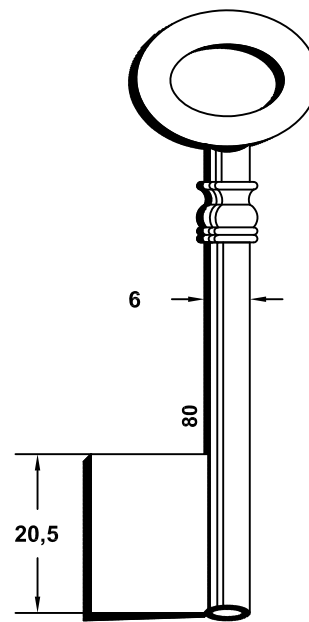

1214G

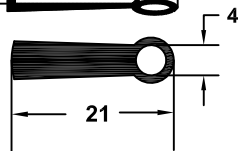
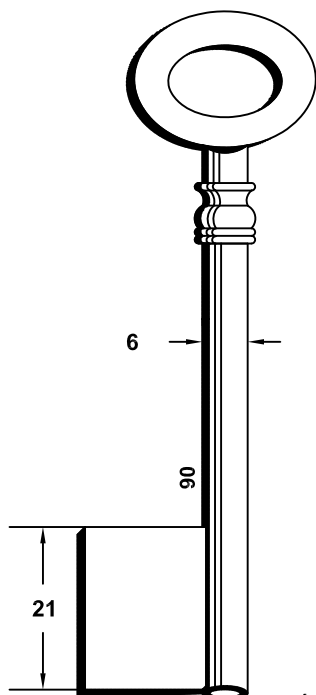

1215G

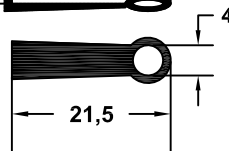
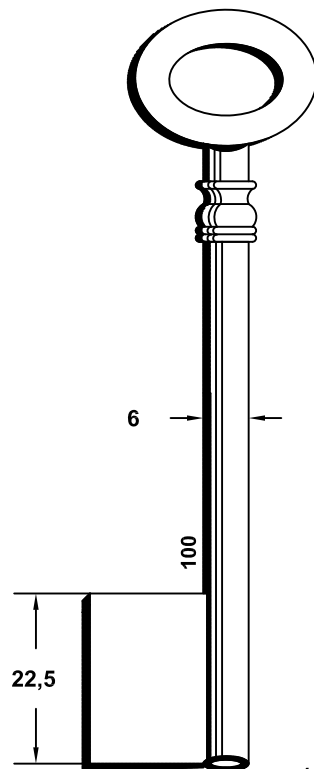

1216G

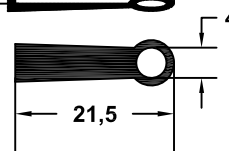
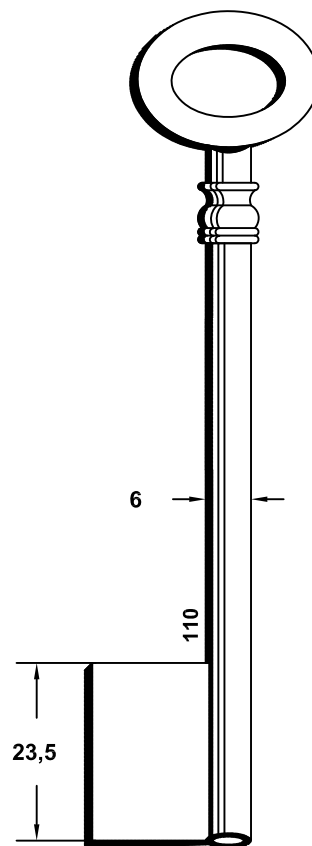

1217G



PARA-FOR:

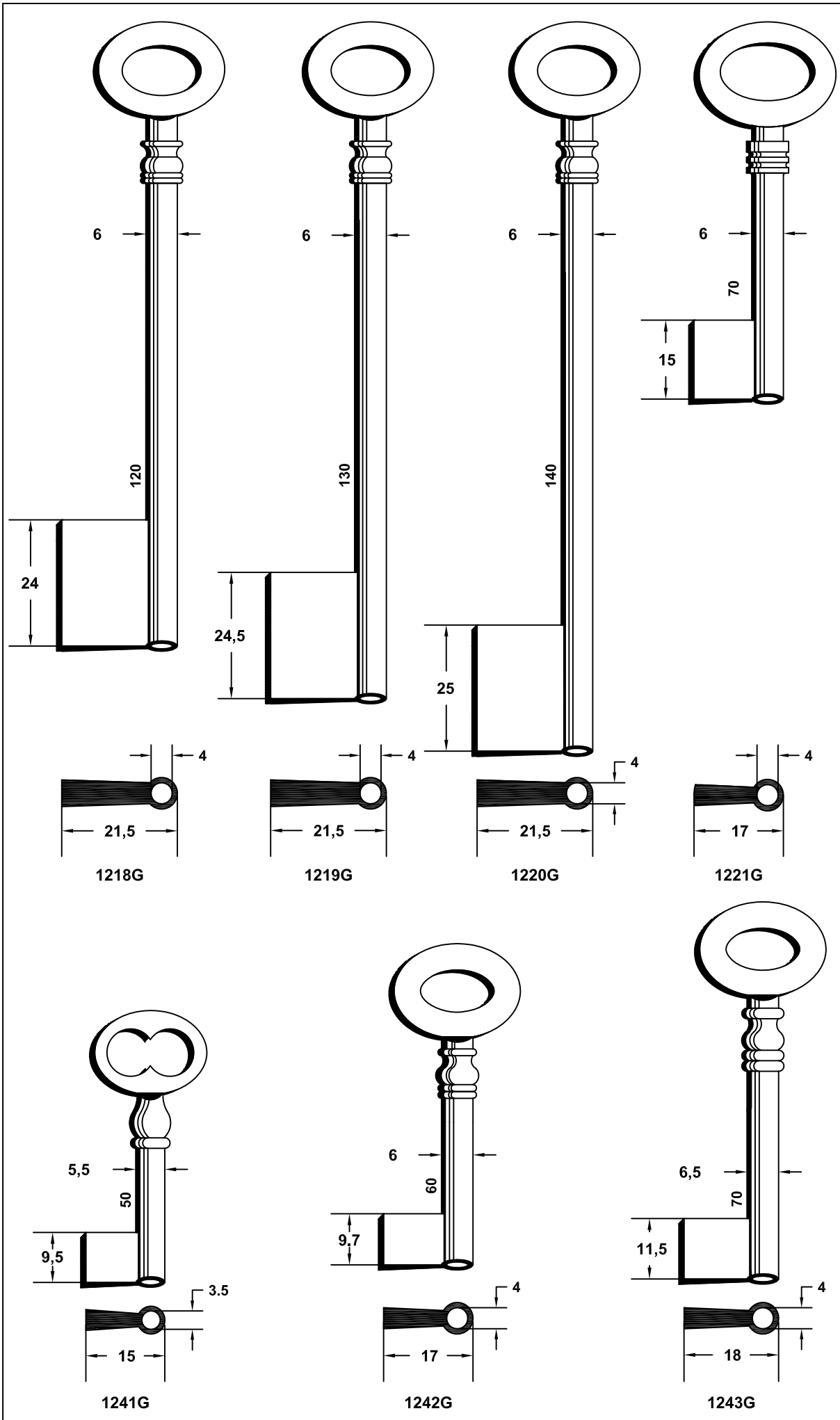

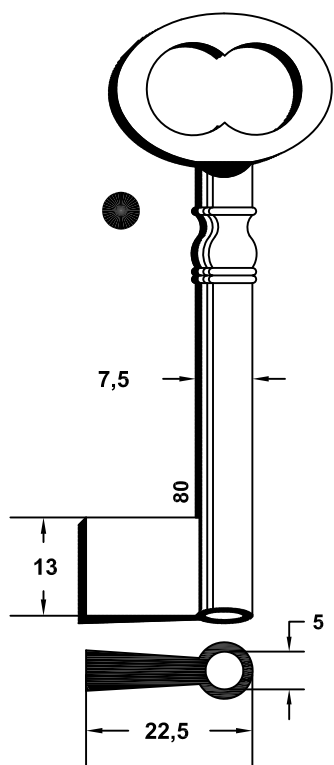

1244G

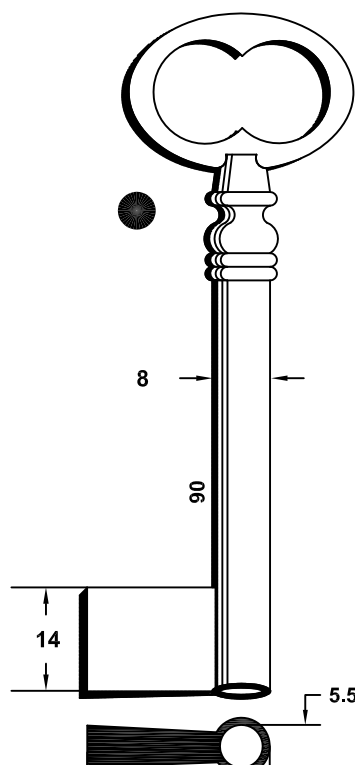

1245G

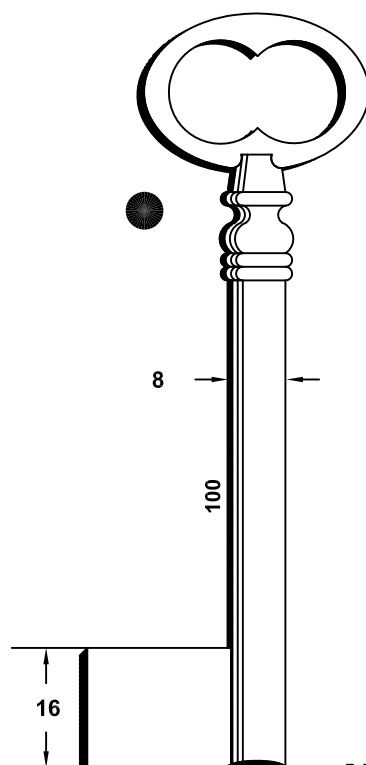

1246G

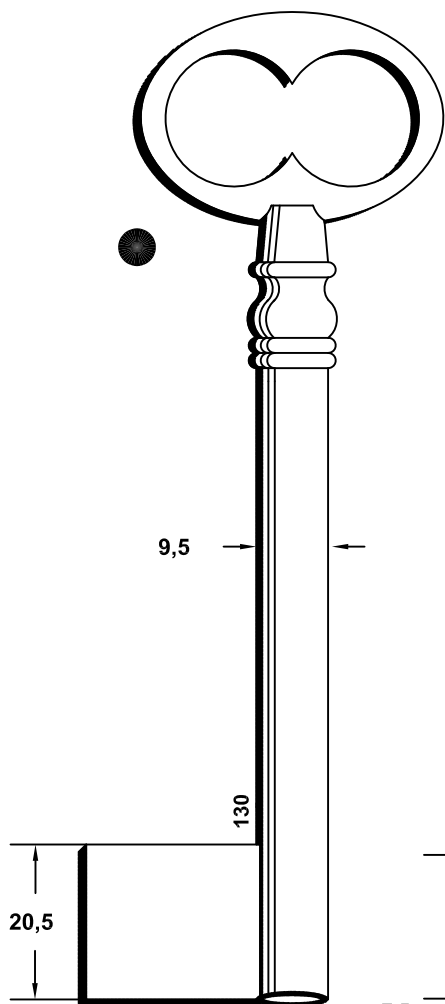

1249G

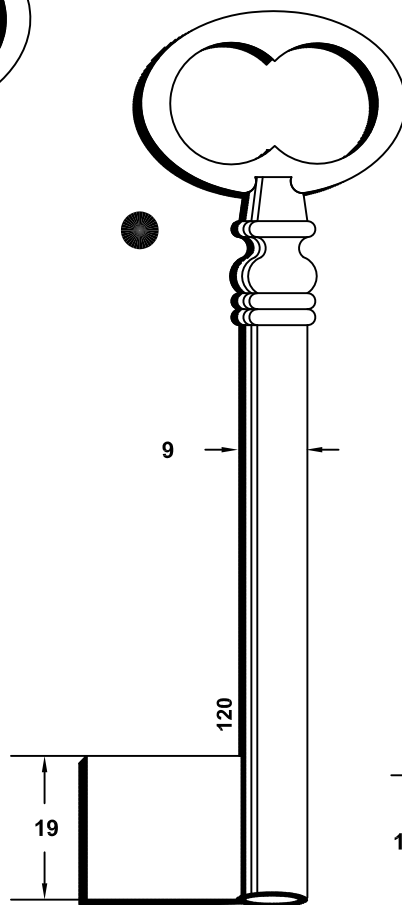

1248G

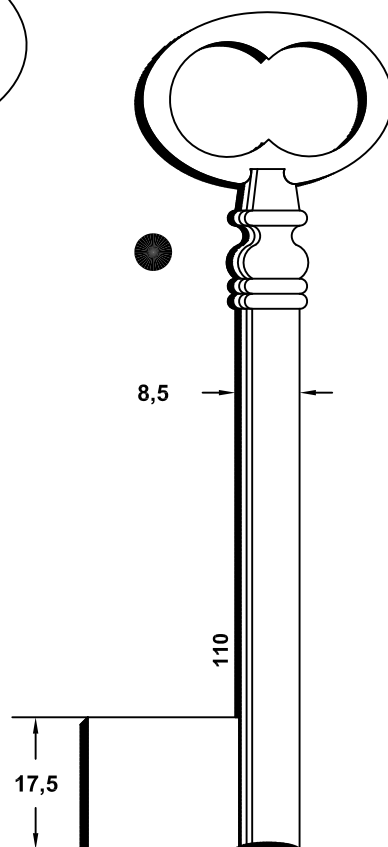

1247G



PARA-FOR:

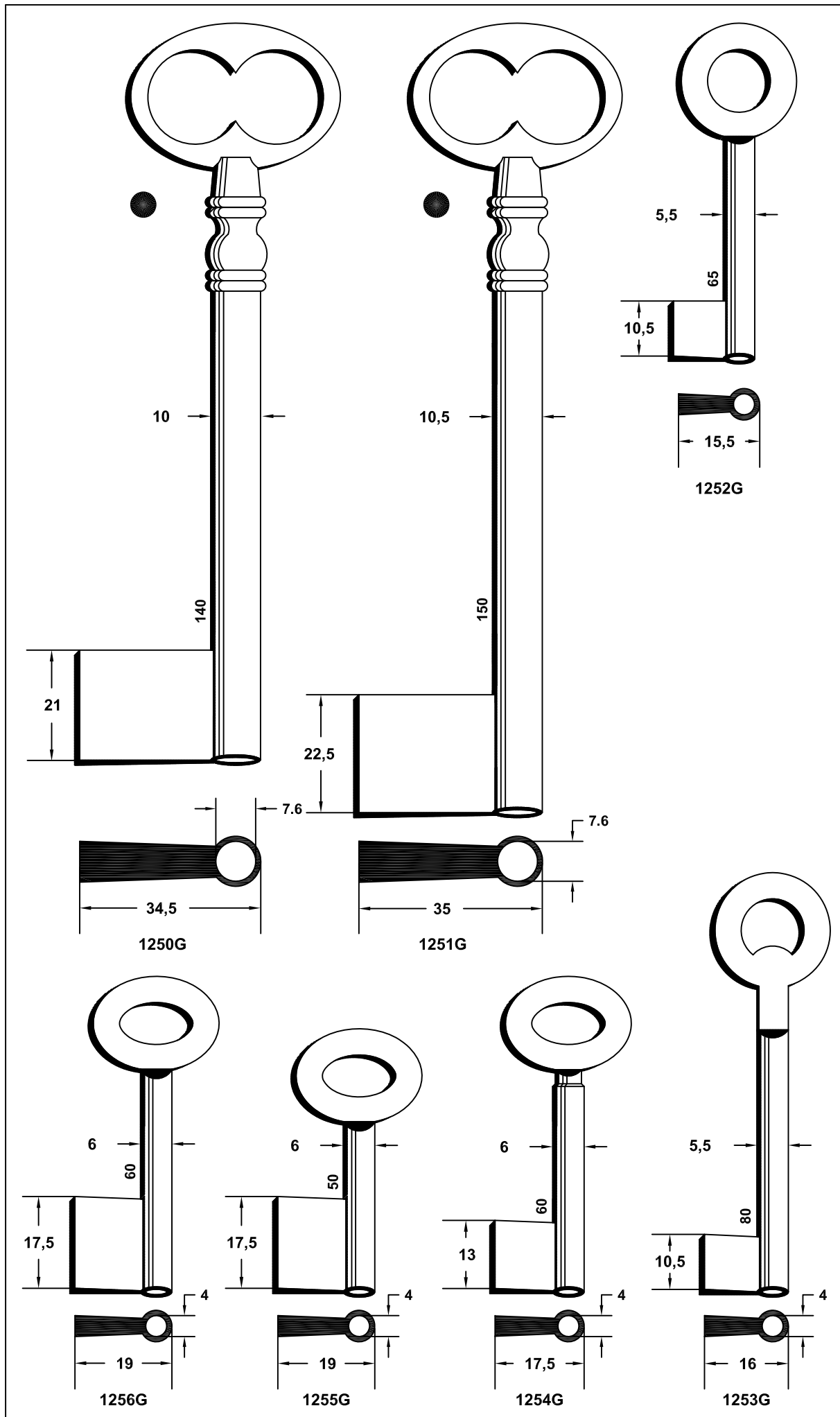

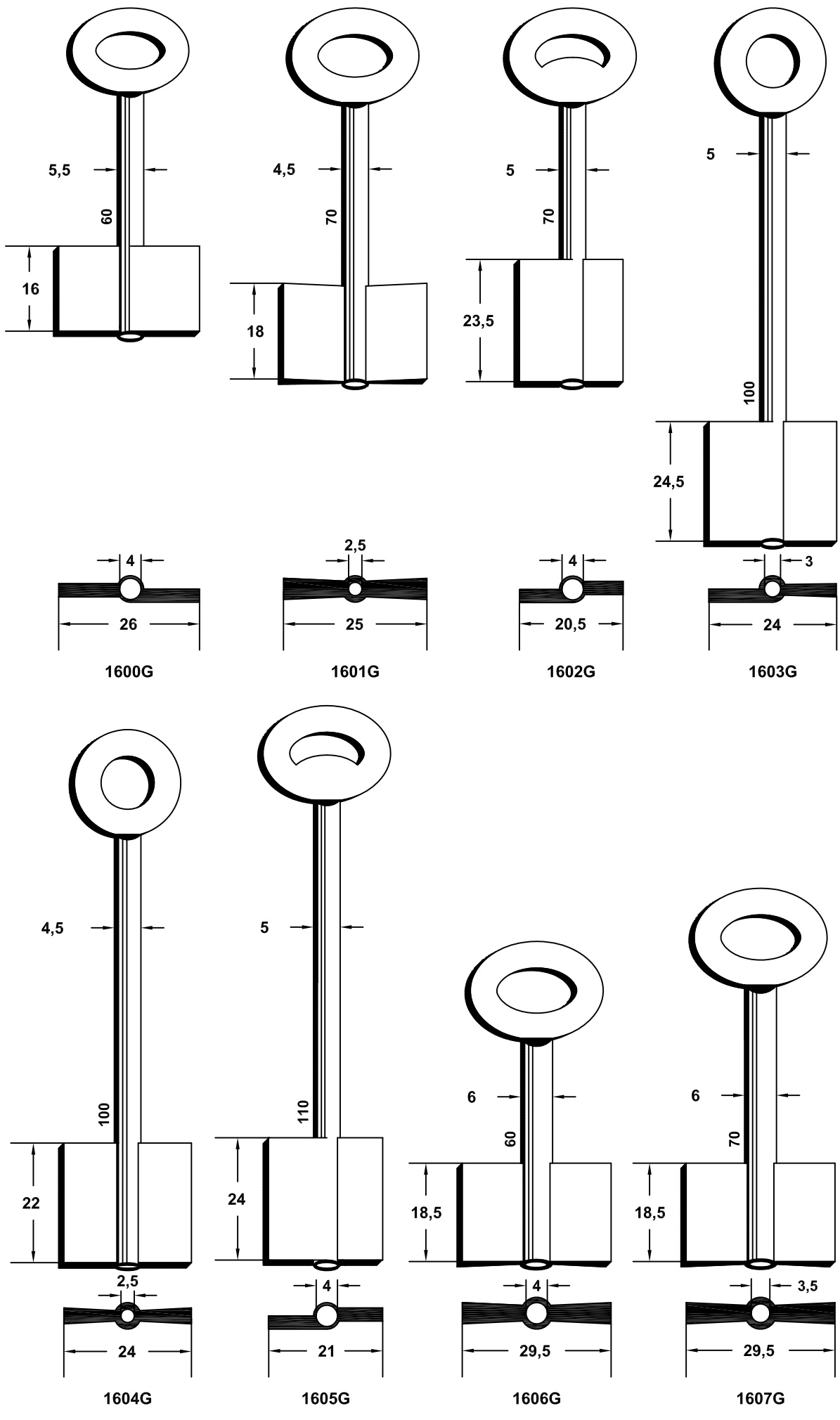

PARA-FOR:

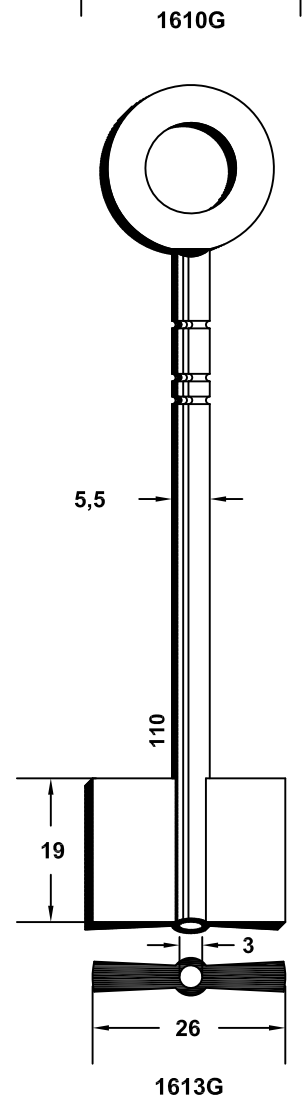
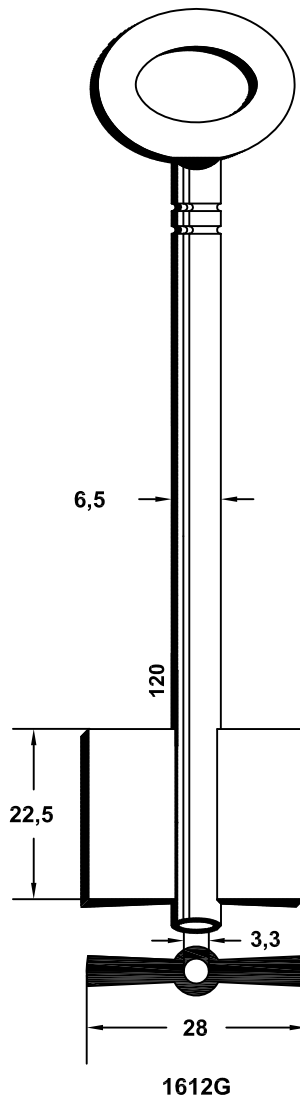
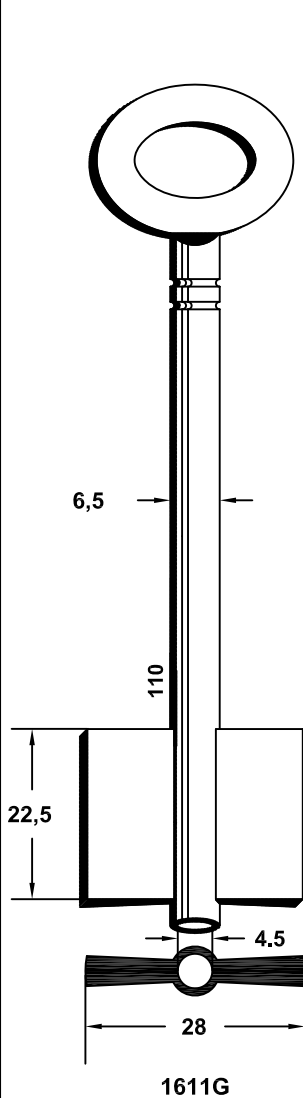
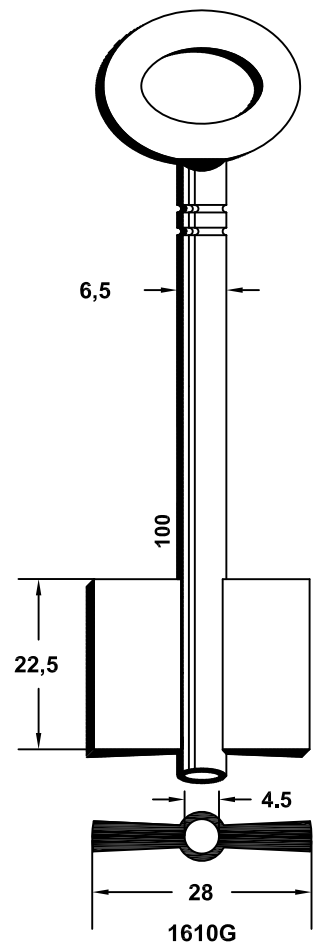
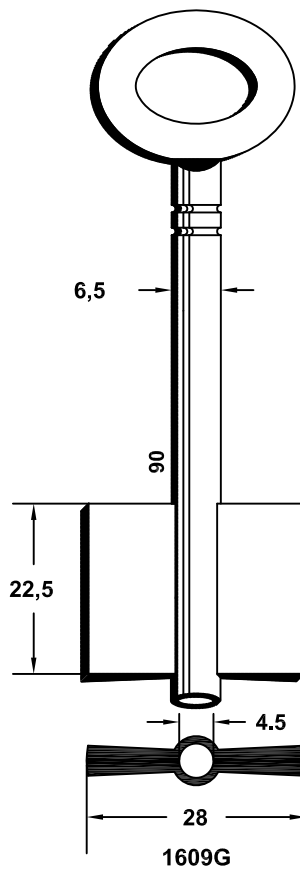
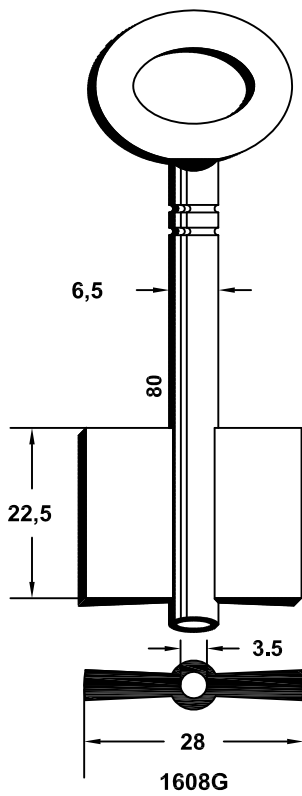

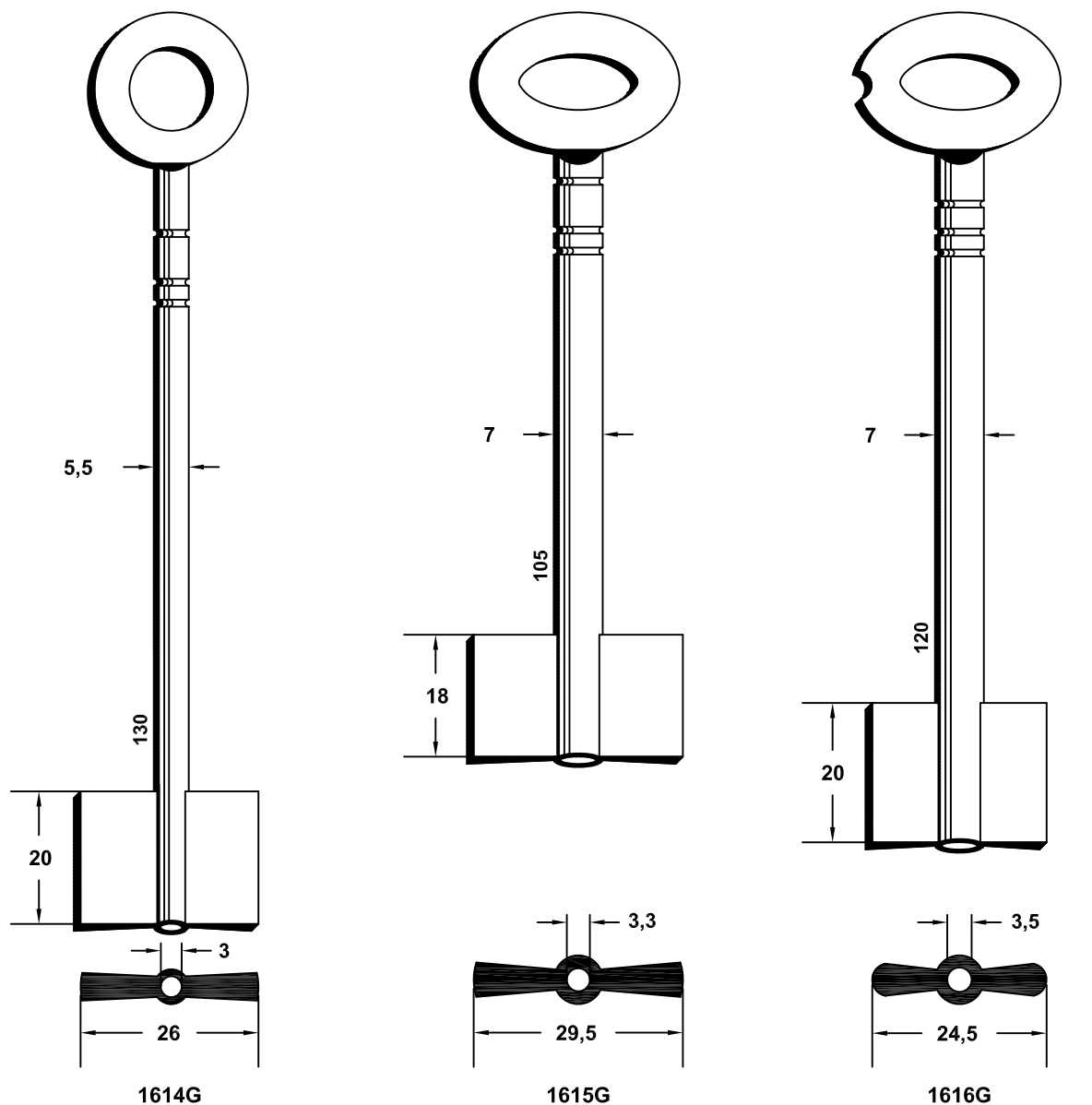

1614G

1615G

1616G

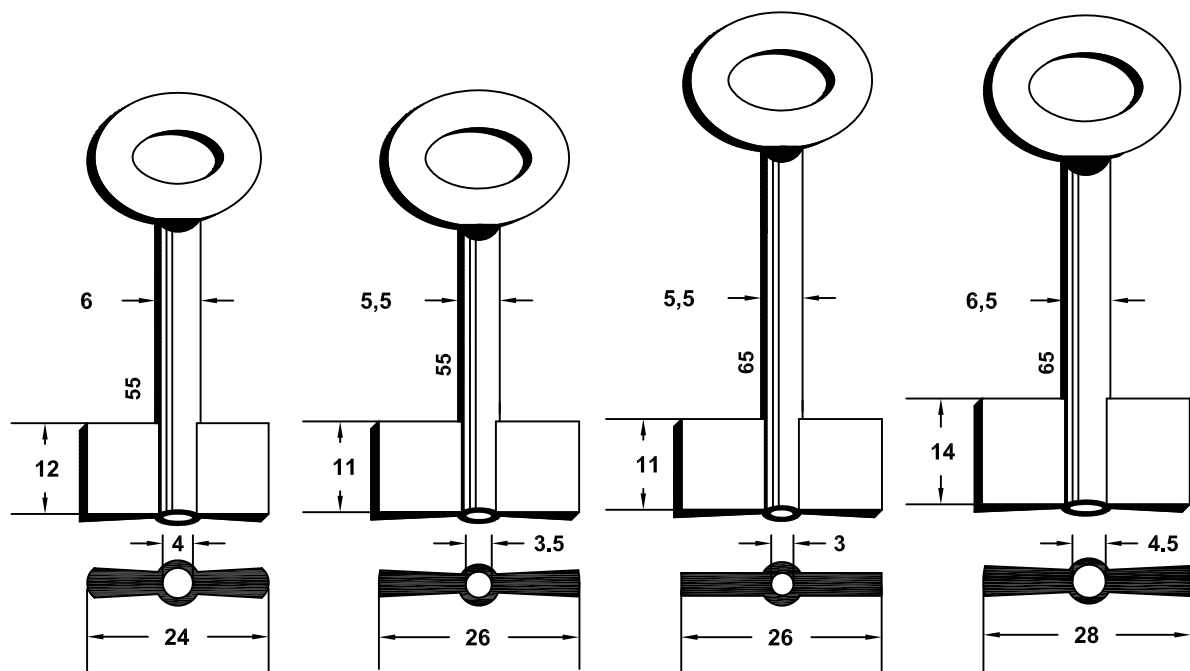

1617G

1618G

1619G

1620G



PARA-FOR:

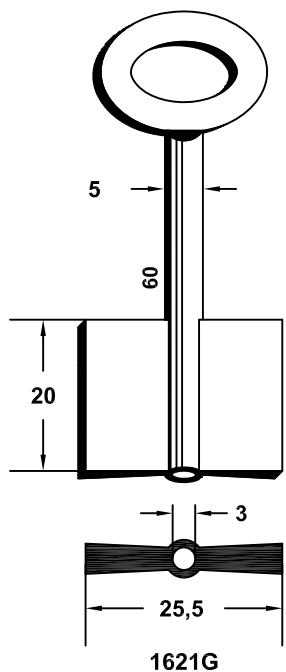

1621G

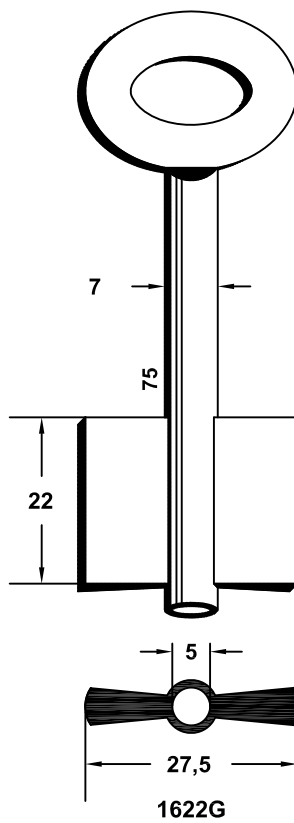

1622G

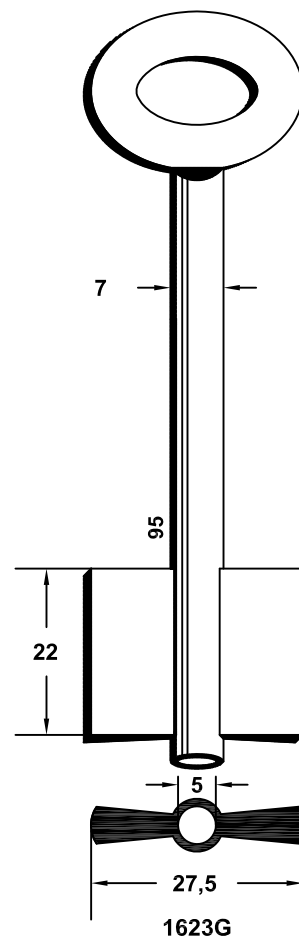

1623G

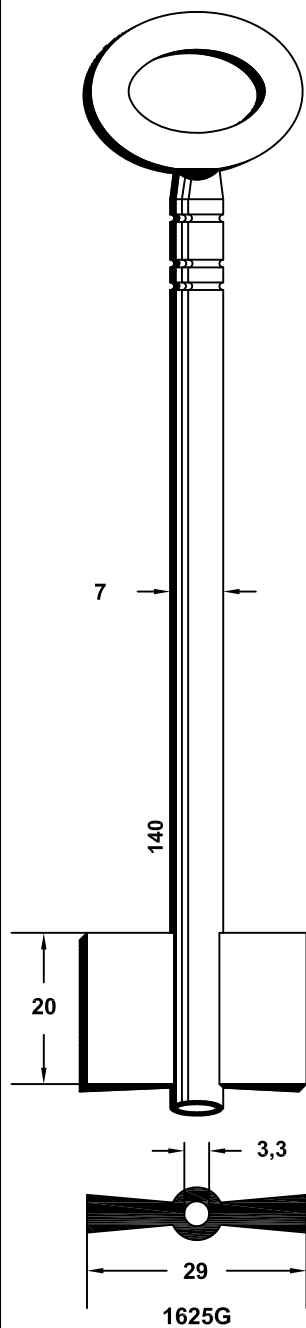

1625G

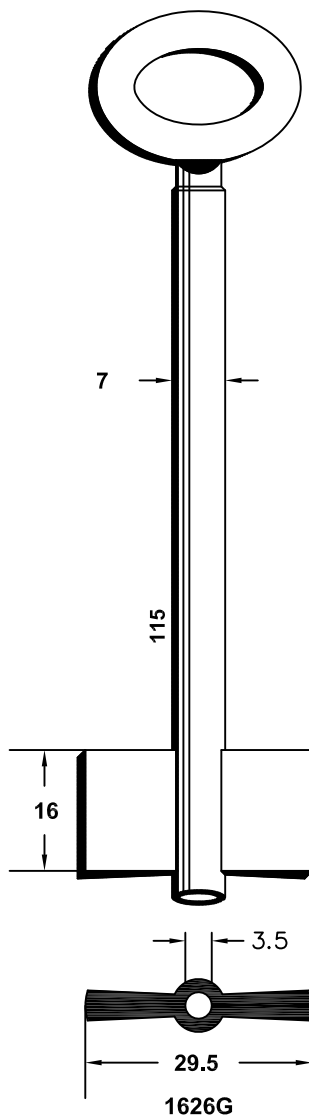

1626G

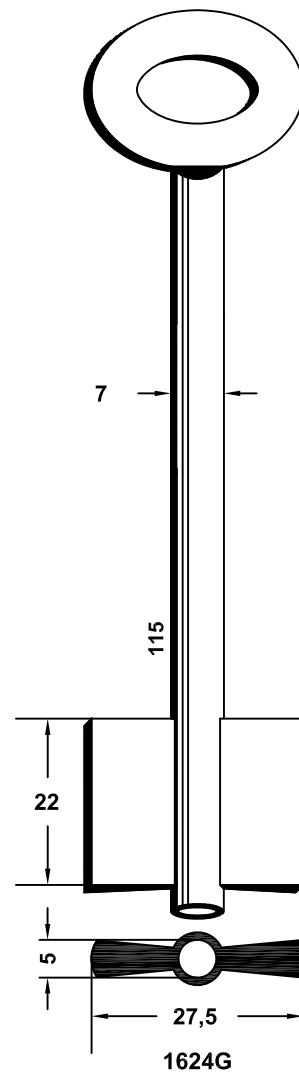

1624G



LLAVES DE GORJA LATÓN

LETOIZKO GORJA GILTZAK

BRASS BIT KEYS

CLES A GORGES EN LAITON

CHUBBSCHLÜSSEL AUS MESSING



THE KEY TO EXCELLENCE
GLOBALLY UNLOCKING MILLIONS OF DOORS DAILY

PARA-FOR:

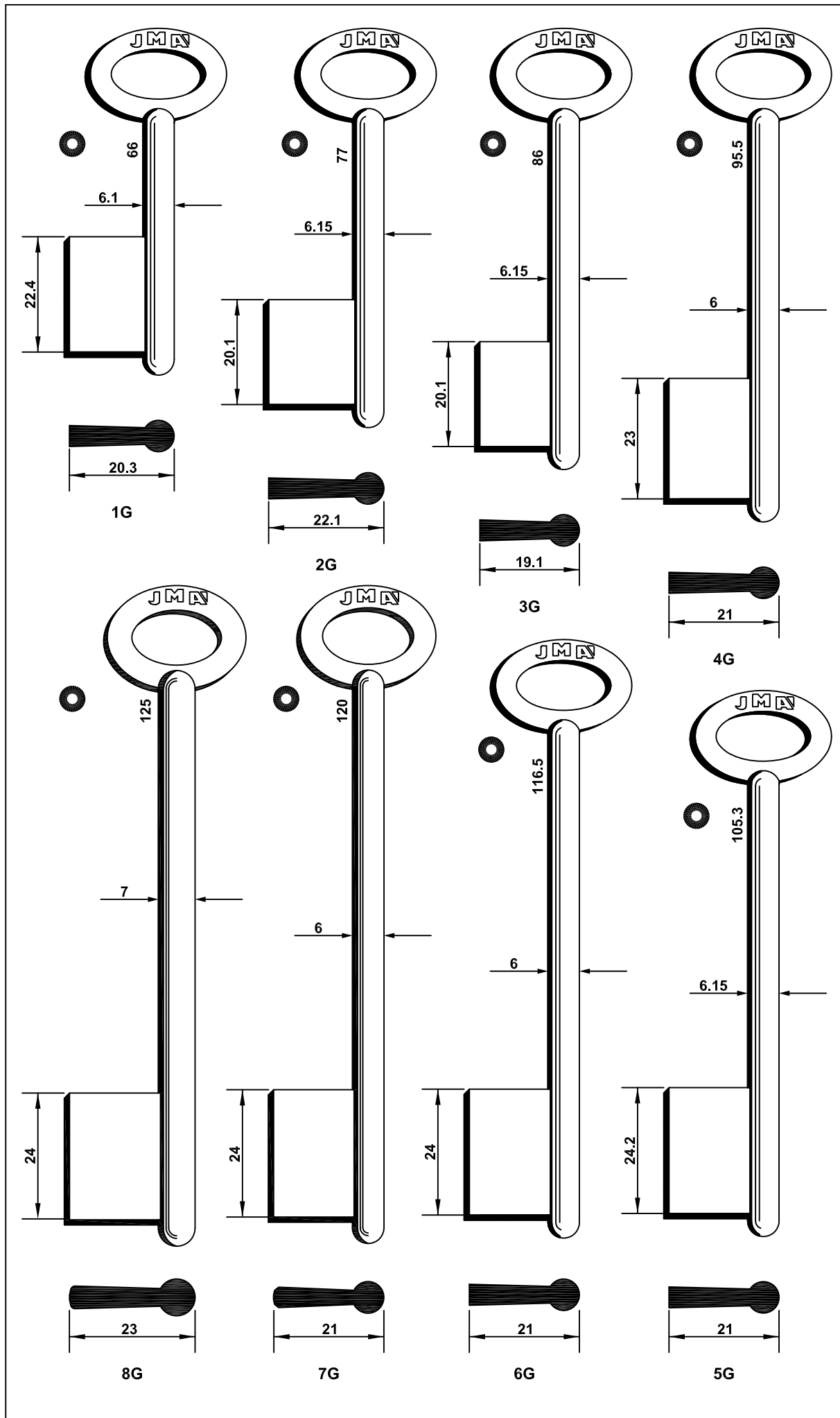

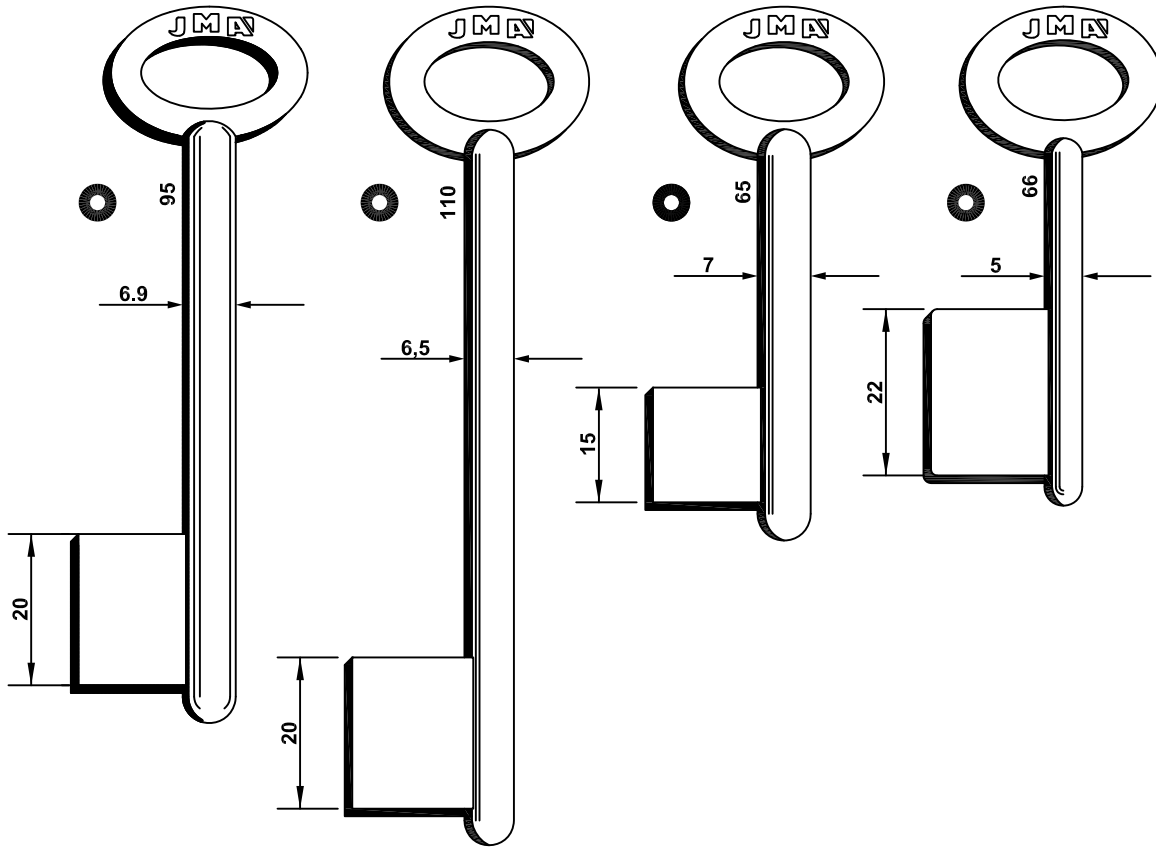

11G

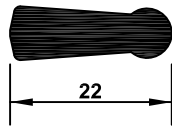

12G

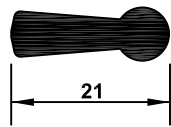

13G

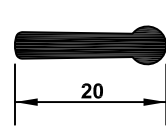

14G

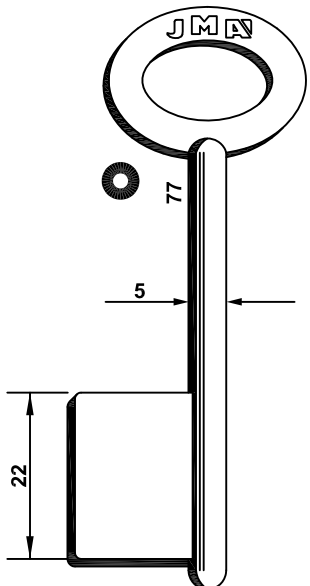

15G

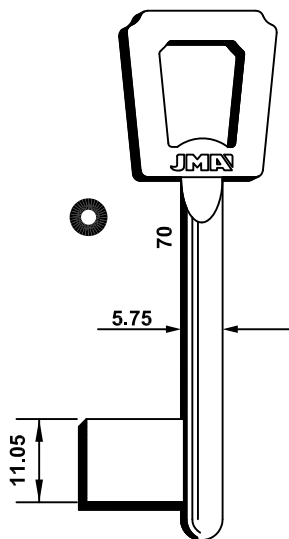

16G

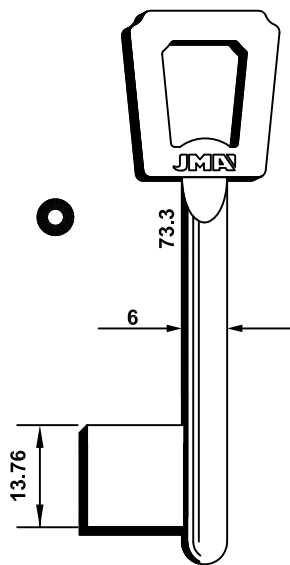

17G

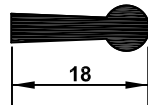
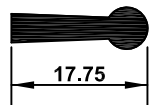
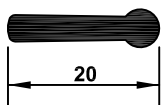

PARA-FOR:

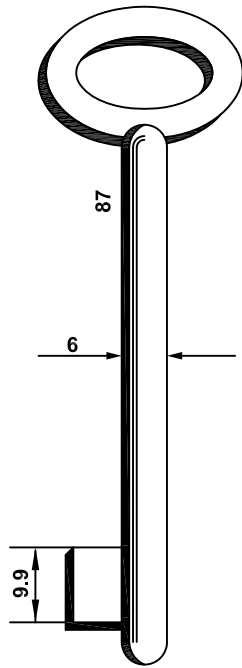

19G

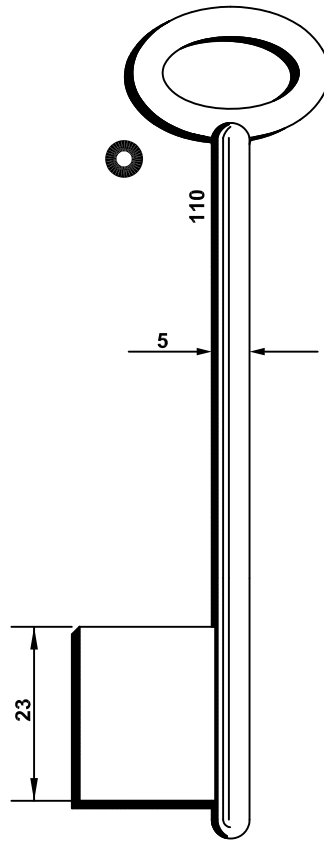

21G

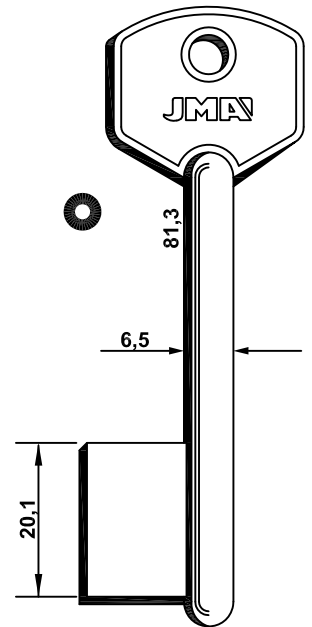
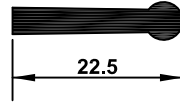

23G

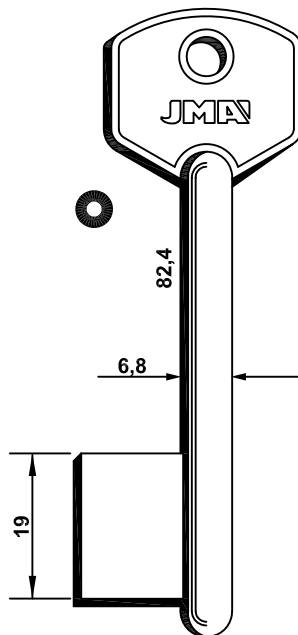
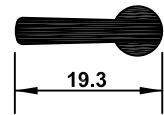

24G

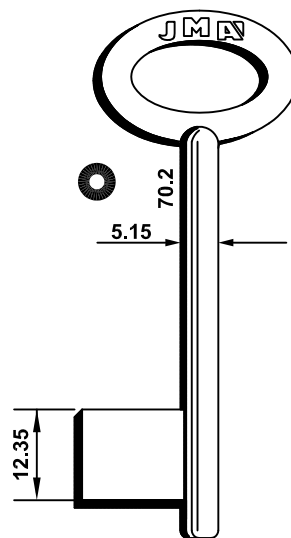
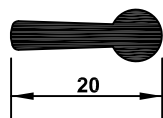

25G

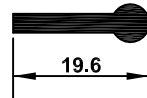

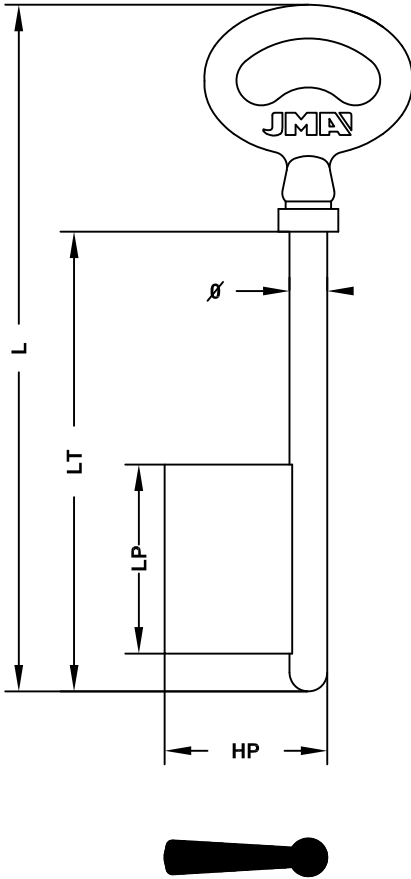

REF.	Ø	L	LT	LP	HP
AD-3	5	90	60	25	21,5
AD-4	5	95	65	25	21,5
AD-5	5	100	70	25	21,5
AD-16	5	110	80	30	21,5
AD-17	5	120	89	35	21,5
AD-6	5,5	80	59	25	22
AD-7	5,5	95	64	25	22
AD-18	5,5	95	64	30	22
AD-8	5,5	100	70	25	21,5
AD-19	5,5	110	80	30	22
AD-20	5,5	120	89	35	22
AD-1	5,8	75	43	18	14
AD-9	5,8	80	50	25	19
AD-21	5,8	95	65	30	22
AD-10	6	90	59	25	22
AD-11	6	95	65	25	22
AD-12	6	100	70	25	22
AD-23	6	110	80	30	22
AD-24	6	120	88	35	22
AD-25	6	140	108	35	22
AD-26	6,5	95	65	30	23
AD-13	6,5	100	70	25	22
AD-29	6,5	100	70	30	23
AD-27	6,5	110	80	30	23
AD-28	6,5	120	90	35	23

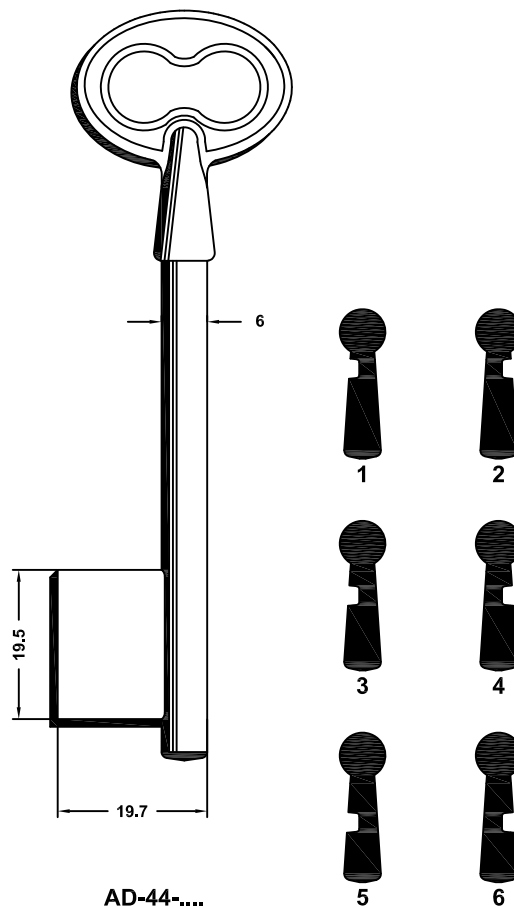
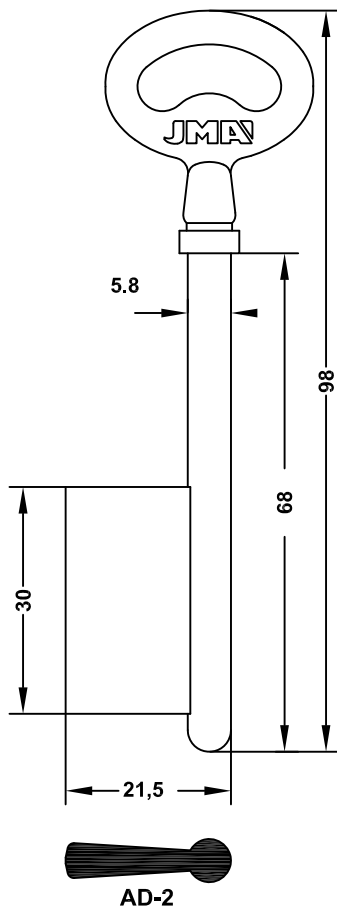

PARA-FOR:

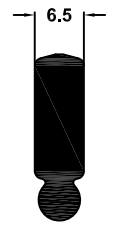

ADPLE-11

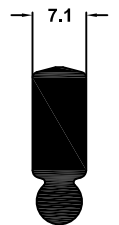
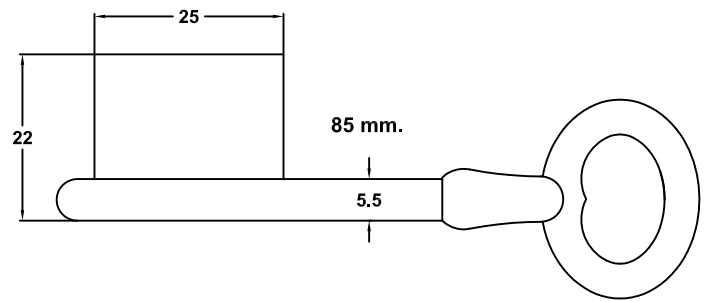

ADPLE-22

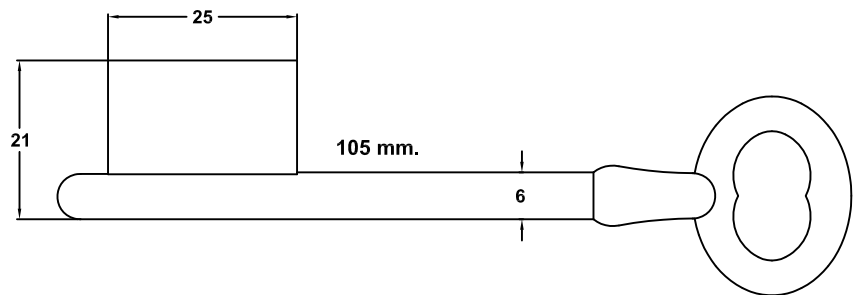

ADPLE-33

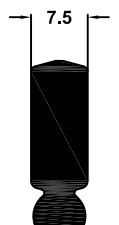
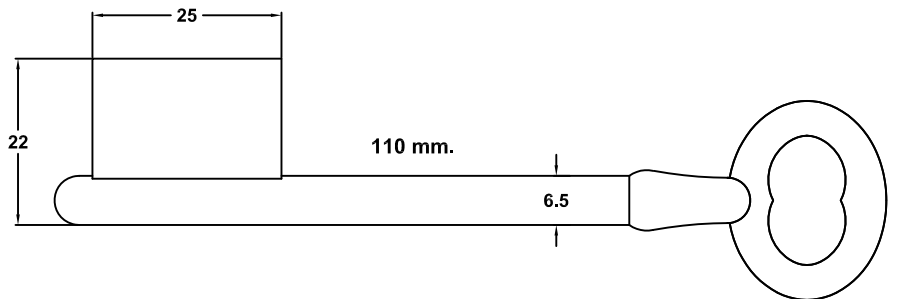

ADPLE-44

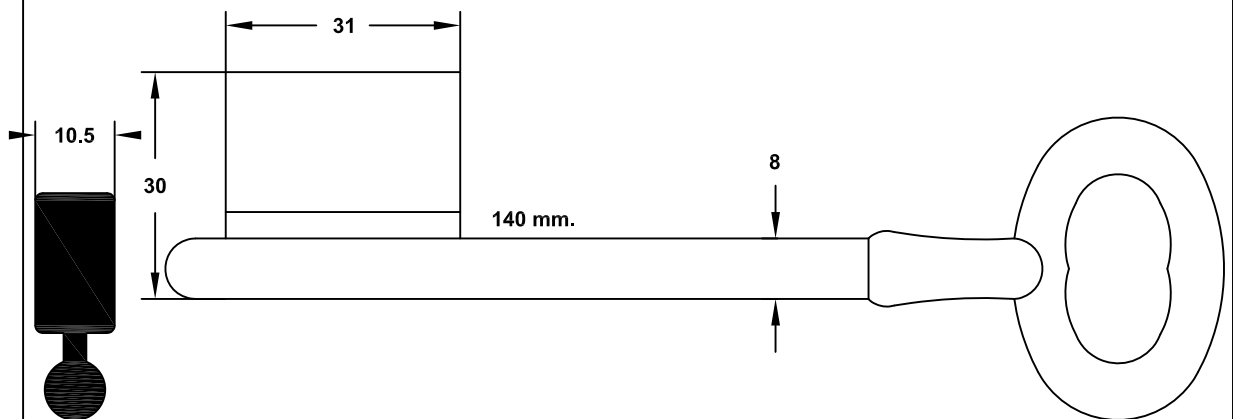
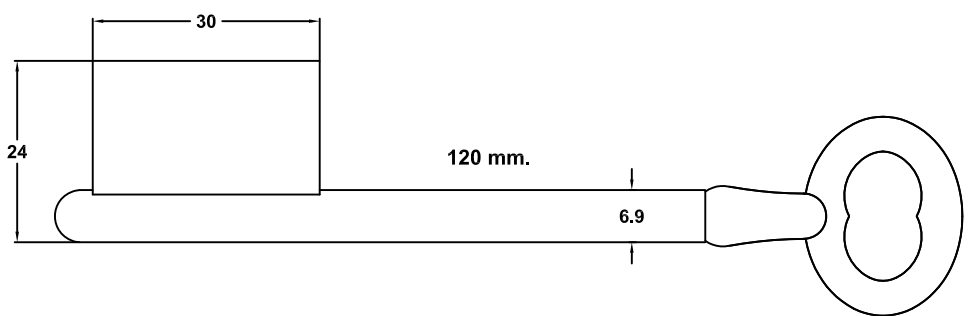

ADPLE-55



126

AGA

PARA-FOR:

126 (S)

AGA (E)

ASSA (S)

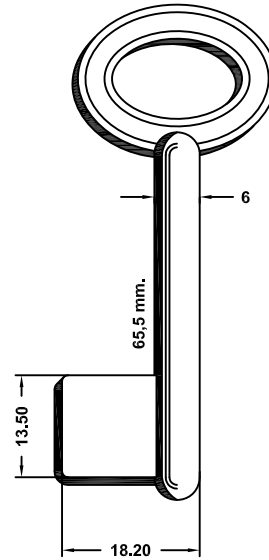
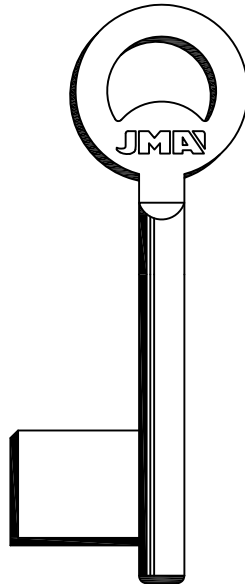
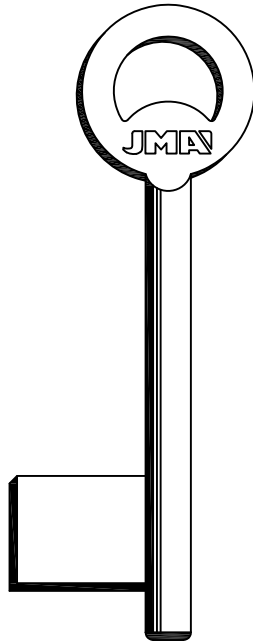
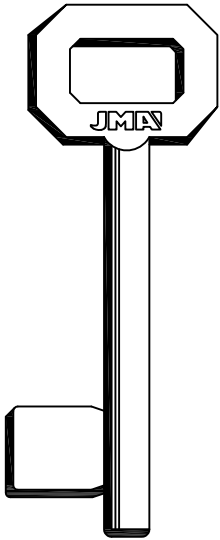

126H-60G



126N-60G



126PP-60G



AGA-1G

ASSA

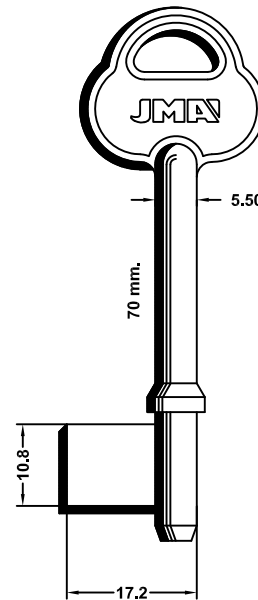
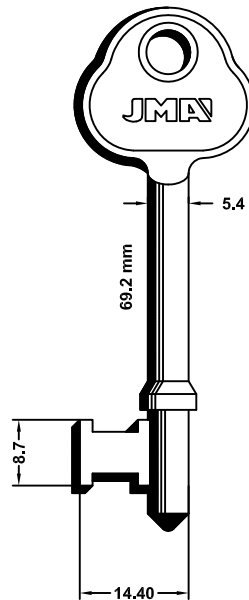
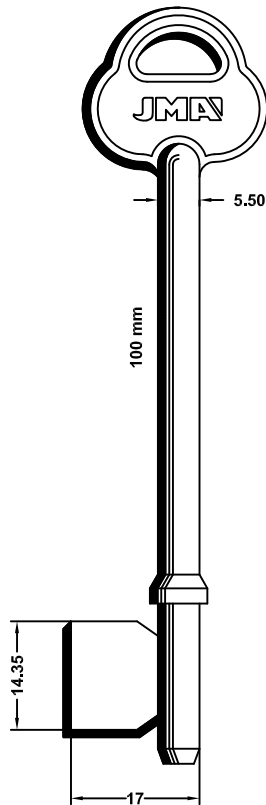
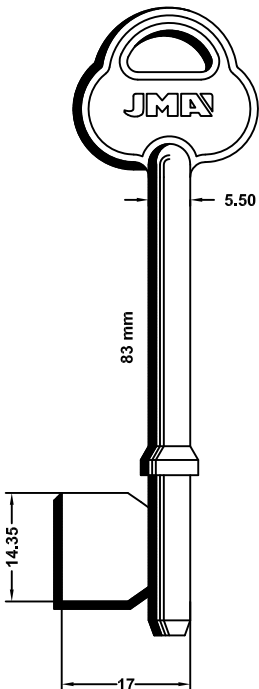

AS-1G



AS-2G



AS-3G



AS-6G/1



PARA-FOR:

ASSA (S)

BODA (SF)

BRICARD (F)

CHUBB (GB)

ASSA	BODA	
<p>AS-6G/2</p>	<p>BOD-4G</p>	<p>BOD-5G</p>

BRICARD	CHUBB	
<p>BRI-6L...</p>	<p>CHU-1G</p>	<p>CHU-2G</p>



DAR-MAR

PARA-FOR:

DAR-MAR (PL)

DEBEAURAIN (F)

ELZETT (H)

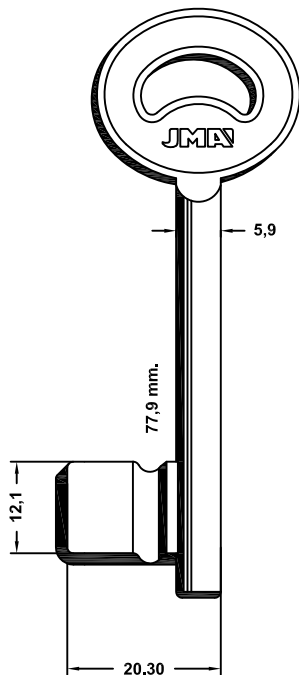
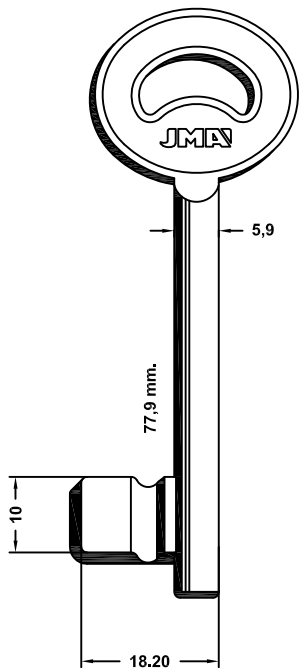

DMR-6-1



DMR-6-3



DMR-6-1L



DMR-6-3L



DMR-6-2



DMR-6-4



DMR-6-2L



DMR-6-4L

DAR-MAR

DEBEAURAIN

ELZETT

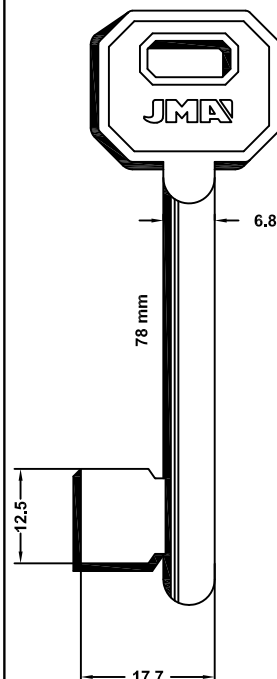
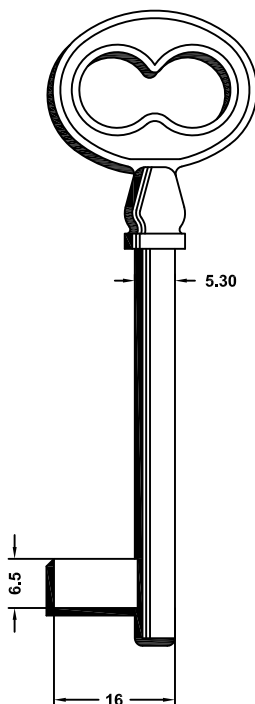
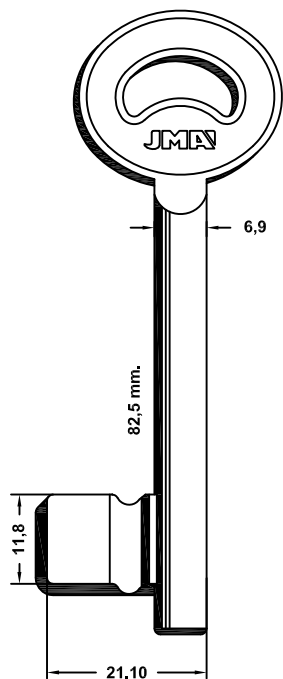

DMR-7-1



DMR-7-3



DMR-7-2



DMR-7-4



DEB-12L



ELZ-2G











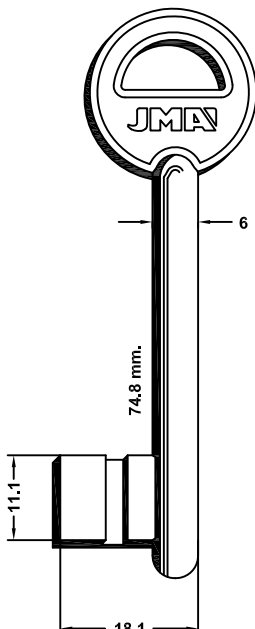

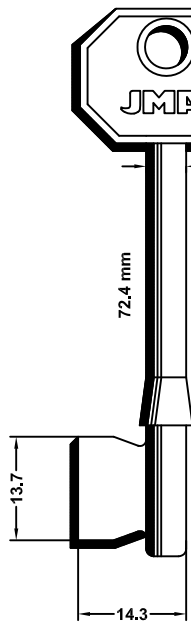

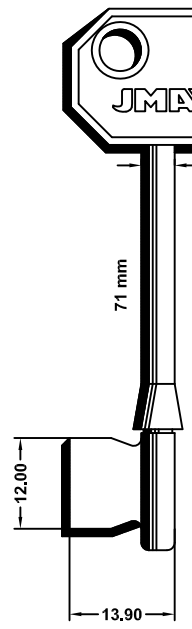

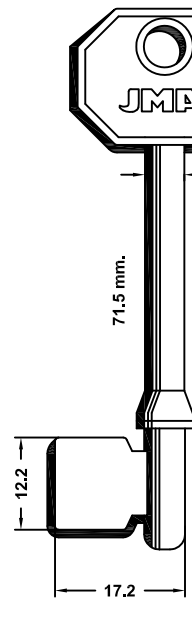

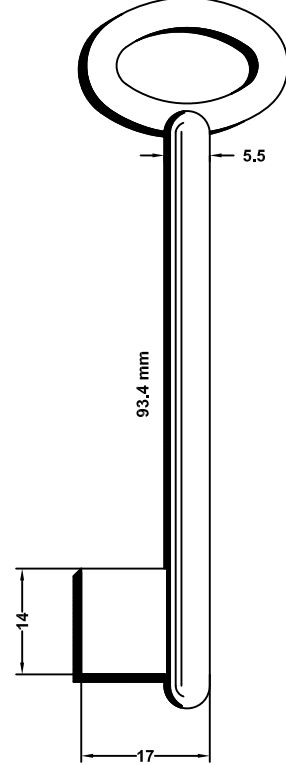
ELZ-3G

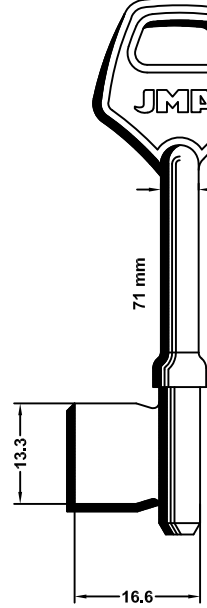

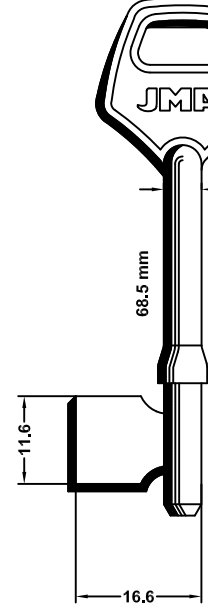
PARA-FOR:

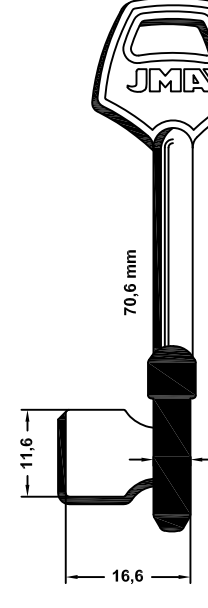
- ELZETT (H)
- ERA (GB)
- ESA (E)
- FAS-YALE (S)

ELZETT	ERA		
 <p>74.8 mm.</p> <p>11.1</p> <p>18.1</p> <p>6</p>  <p>ELZ-5G</p>  <p>ELZ-6G</p>	 <p>72.4 mm</p> <p>13.7</p> <p>14.3</p> <p>5.30</p>  <p>ER-1G</p>	 <p>71 mm</p> <p>12.00</p> <p>13.90</p> <p>4.90</p>  <p>ER-4G</p>	 <p>71.5 mm.</p> <p>12.2</p> <p>17.2</p> <p>5.2</p>  <p>ER-5G</p>
ESA	FAS-YALE		
 <p>93.4 mm</p> <p>14</p> <p>17</p> <p>5.5</p>  <p>ES-1G</p>	 <p>71 mm</p> <p>13.3</p> <p>16.6</p> <p>5.34</p>  <p>FA-1G</p>	 <p>68.5 mm</p> <p>11.6</p> <p>16.6</p> <p>4.84</p>  <p>FA-2G</p>	 <p>70.6 mm</p> <p>11.6</p> <p>16.6</p> <p>4.9</p>  <p>FA-2PPG</p>



FAS-YALE

PARA-FOR:

FAS-YALE (S)

FICHET (F)

GPZ (RUS)

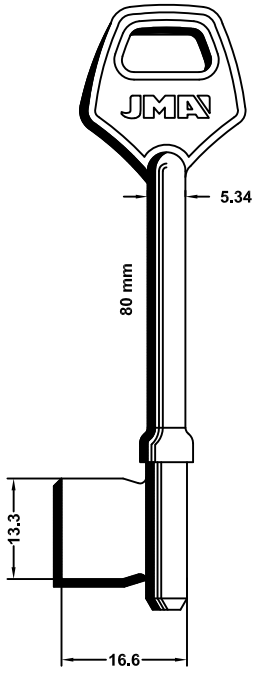

FA-3G

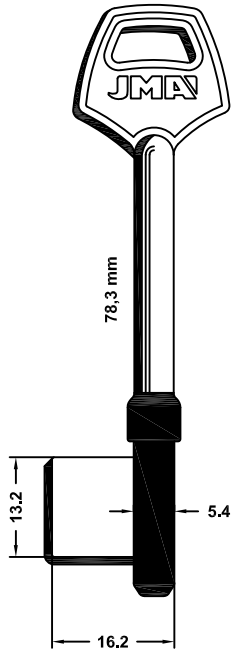

FA-3PPG

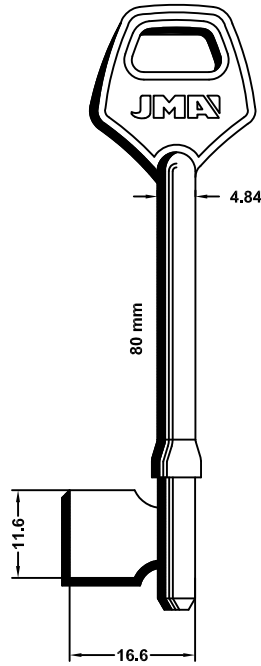

FA-4G

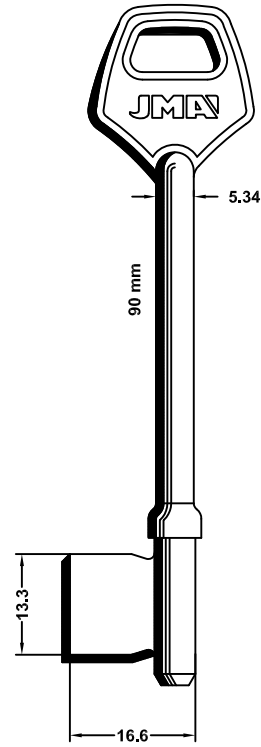

FA-5G

FAS-YALE

FICHET

GPZ

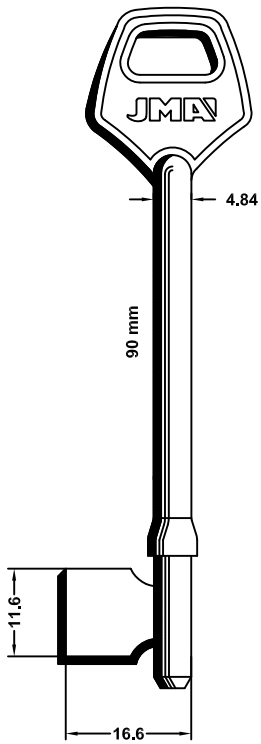

FA-6G

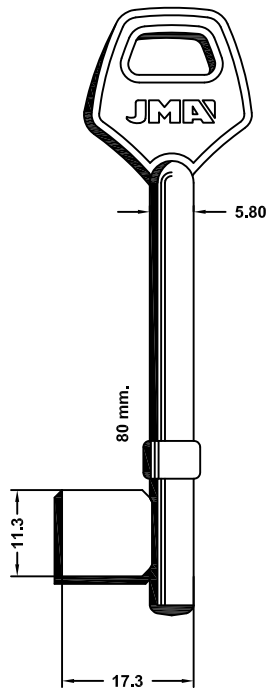

FA-7G

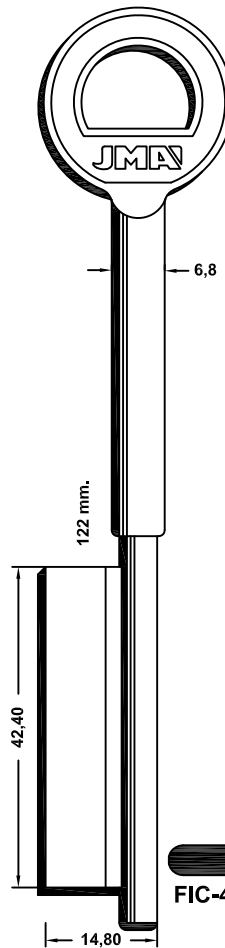

FIC-401G

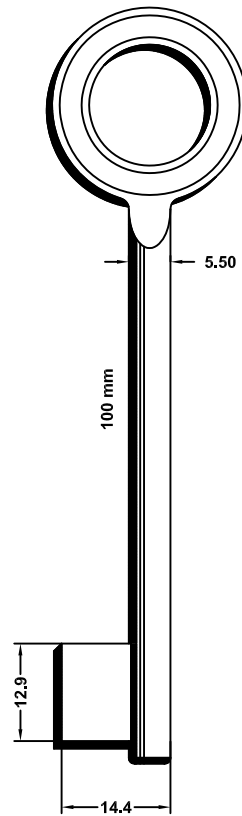









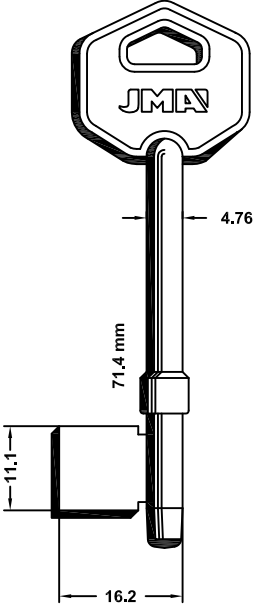

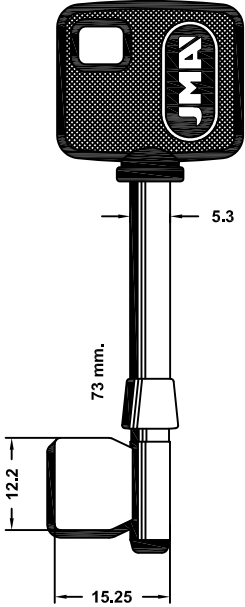

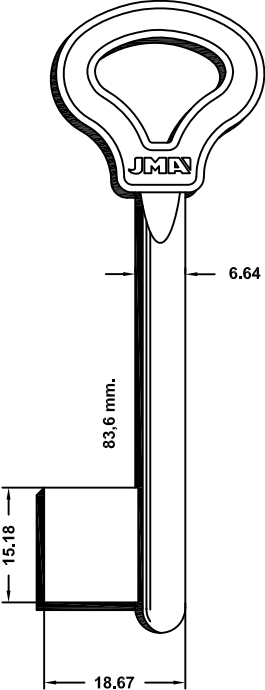

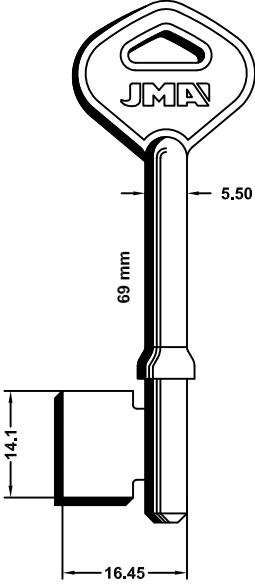

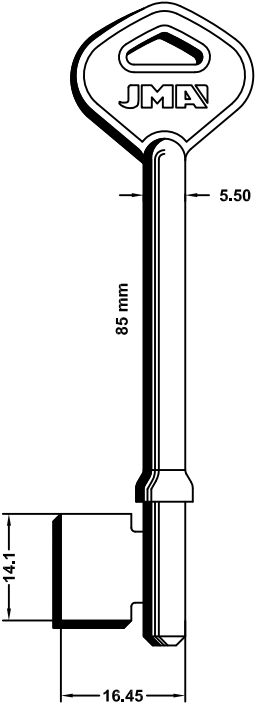
GPZ-1G

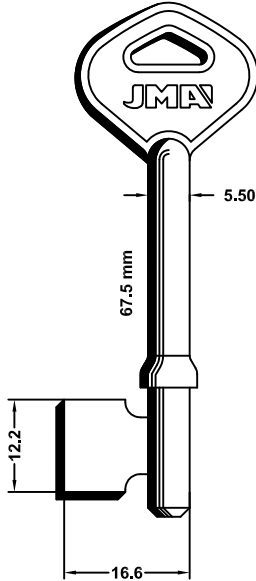

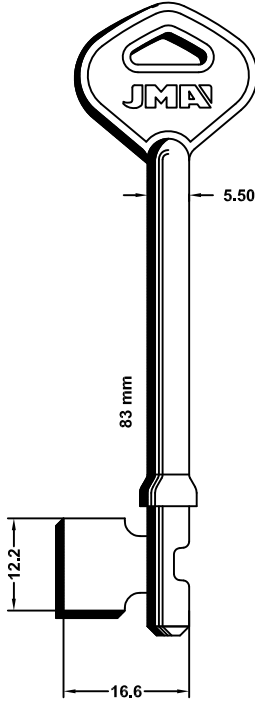
PARA-FOR:

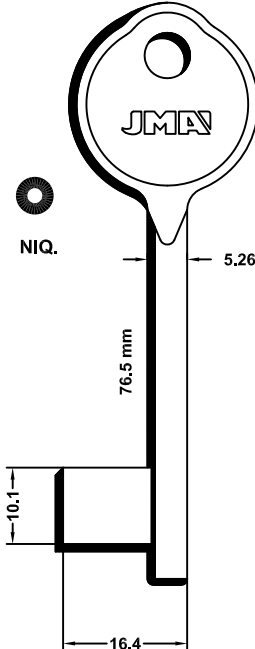
- GUARDIAN (GB)
- HENDERSON (GB)
- LAR (E)
- LÅSBOLAGET (S)
- MCM (E)

GUARDIAN	HENDERSON	LAR	LÅSBOLAGET
 <p>4.76 71.4 mm 11.1 16.2</p>  <p>GUR-1G</p>	 <p>5.3 73 mm. 12.2 15.25</p>  <p>HEN-1G.P</p>	 <p>6.64 83.6 mm. 15.18 18.67</p>  <p>LAR-1G</p>	 <p>5.50 69 mm 14.1 16.45</p>  <p>LASB-1G</p>
LÅSBOLAGET			MCM
 <p>5.50 85 mm 14.1 16.45</p>  <p>LASB-2G</p>	 <p>5.50 67.5 mm 12.2 16.6</p>  <p>LASB-3G</p>	 <p>5.50 83 mm 12.2 16.6</p>  <p>LASB-4G</p>	 <p>NIQ. 5.26 76.5 mm 10.1 16.4</p>  <p>MCM-1G</p>



MCM	MOSKVA	MP	ORENGO
<p>MCM-4G</p>	<p>MOK-1G</p>	<p>MPA-1G</p>	<p>OR-3G</p>

PARA-FOR:
MCM (E)
MOSKVA (RUS)
MP (I)
ORENGO (E)
OSTMARK (D)
PASSEPARTOUT

ORENGO	OSTMARK		PASSEPARTOUT												
<p>OR-6G</p>	<p>OST-1G</p>	<p>OST-2G</p>	<table border="1"> <thead> <tr> <th></th> <th>A</th> <th>B</th> </tr> </thead> <tbody> <tr> <td>PPT-3G</td> <td>14,5</td> <td>7,6</td> </tr> <tr> <td>PPT-2G</td> <td>16,5</td> <td>7,9</td> </tr> <tr> <td>PPT-1G</td> <td>18</td> <td>7,6</td> </tr> </tbody> </table> <p>PPT-3G BONAITI-MAVE-OASA-PATENT PERINO-STIQUAM</p> <p>PPT-2G AGB-CORNI-MP-OSMET-PATENT SMET</p> <p>PPT-1G BONAITI-ISEO-MP</p>		A	B	PPT-3G	14,5	7,6	PPT-2G	16,5	7,9	PPT-1G	18	7,6
	A	B													
PPT-3G	14,5	7,6													
PPT-2G	16,5	7,9													
PPT-1G	18	7,6													



PARA-FOR:

- RENAG (N)
- REX (N)
- TESA (E)
- TRIO-VING (N)

	RENAG	REX		TESA
	TESA		TRIO-VING	



TRIO-VING

PARA-FOR:
TRIO-VING (N)

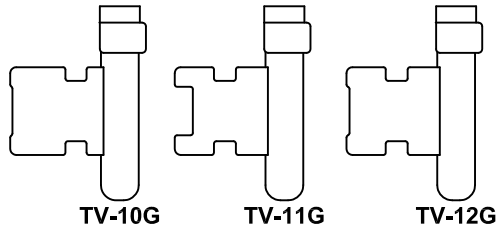
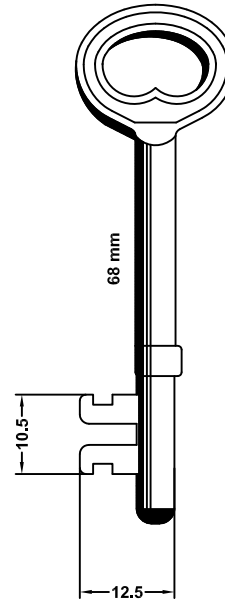
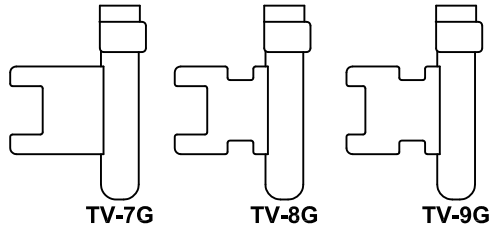
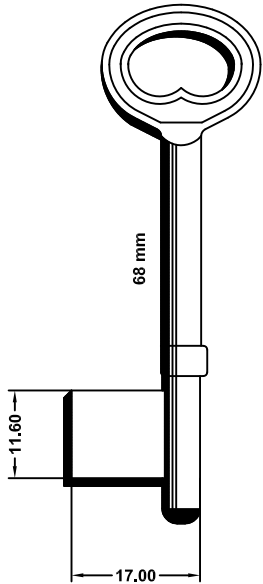

TRIO-VING

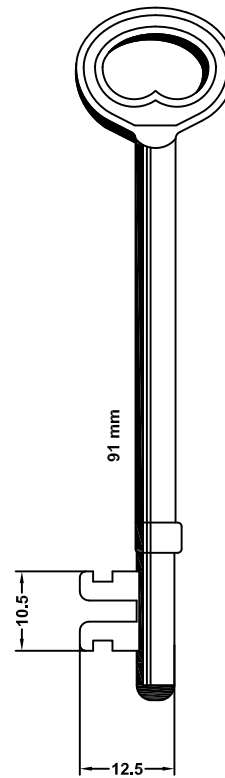
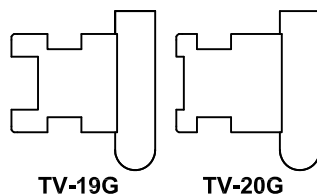
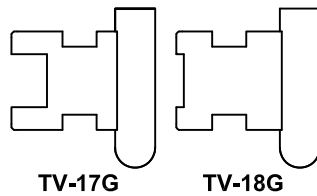
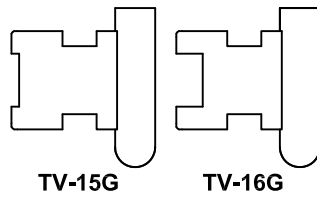
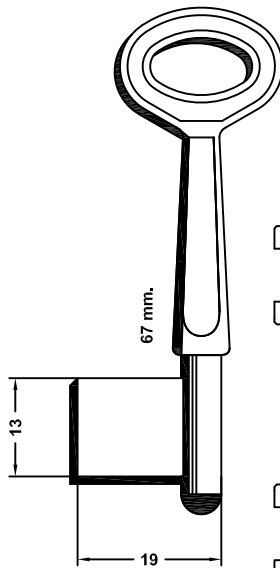
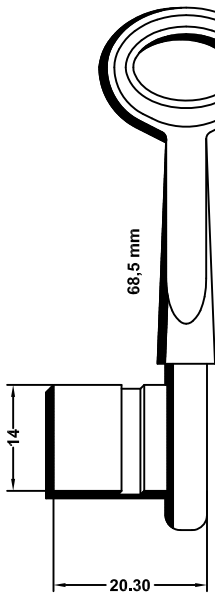

PARA-FOR:

TRIO-VING (N)

UCEM (E)

UNION (GB)

WMS (GB)

YALE (GB)

TRIO-VING		UCEM	
UCEM	UNION	WMS	YALE



AKARSAN

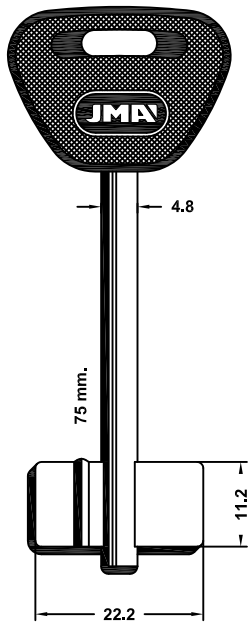

AKA-1PG

ANTONIOLI

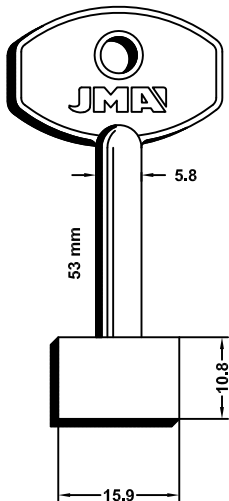

ANT-1G

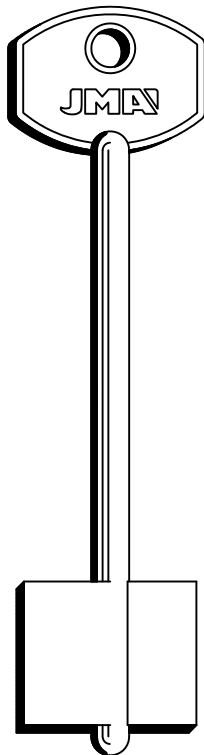

ANT-2G

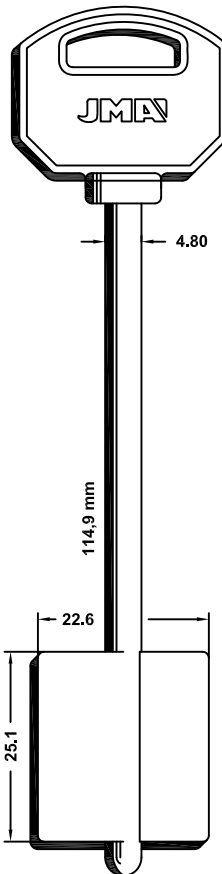

ANT-3G

PARA-FOR:

AKARSAN (TR)

ANTONIOLI (I)

ASSA (S)

ATRA (I)

ANTONIOLI

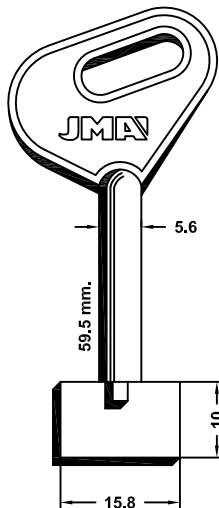

ANT-4G

AUNO

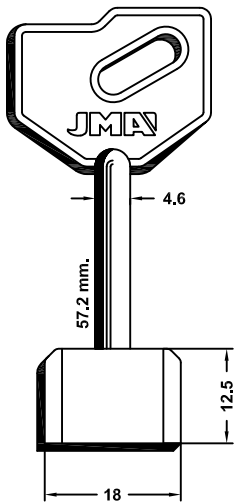

ANT-5G

AUNO

ASSA

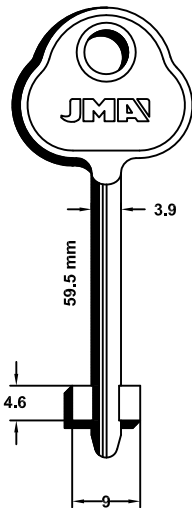

AS-4G

ATRA

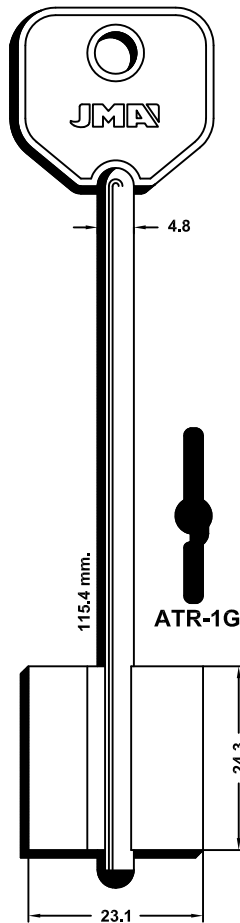

ATR-1G



PARA-FOR:

ATRA (I)

BETA (I)

ATRA

BETA

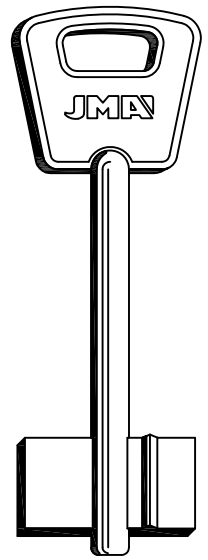
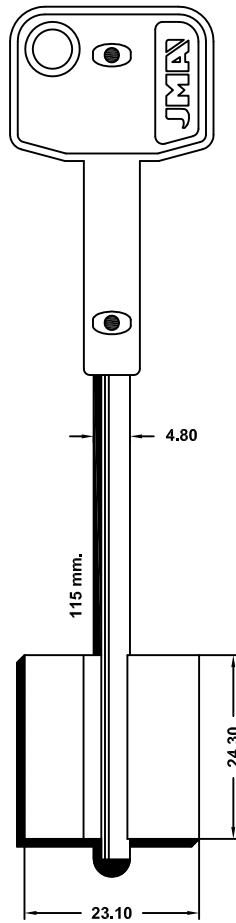
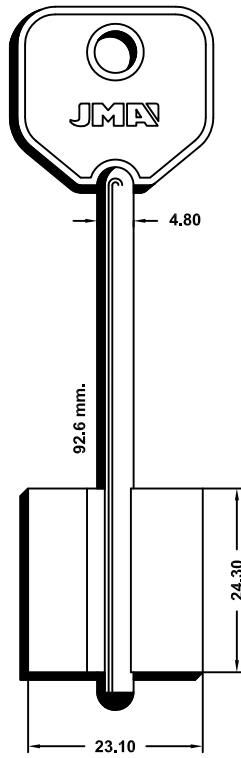

BETA

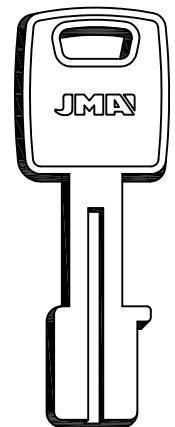
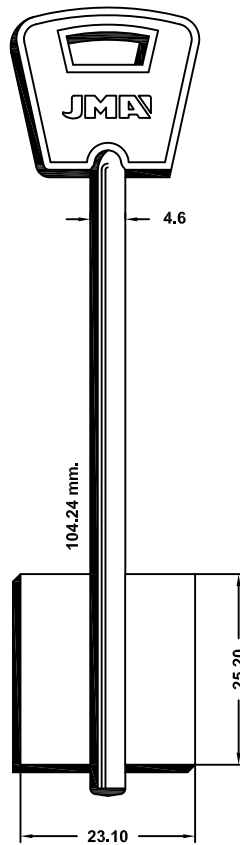
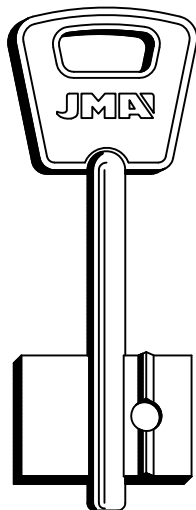

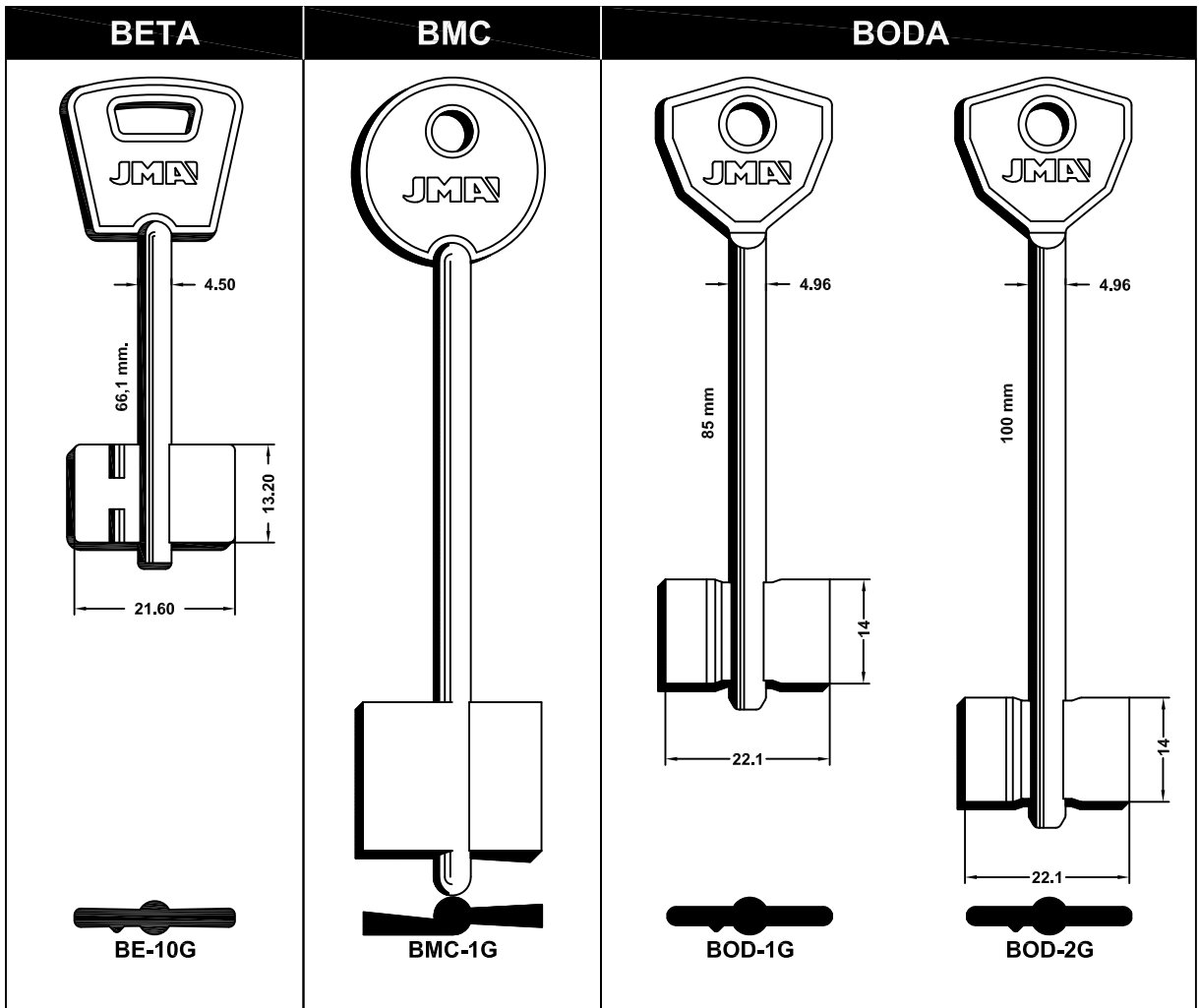

PARA-FOR:
 BETA (I)
 BMC (I)
 BODA (SF)
 BOGATIR (RUS)
 BOXAFE (I)

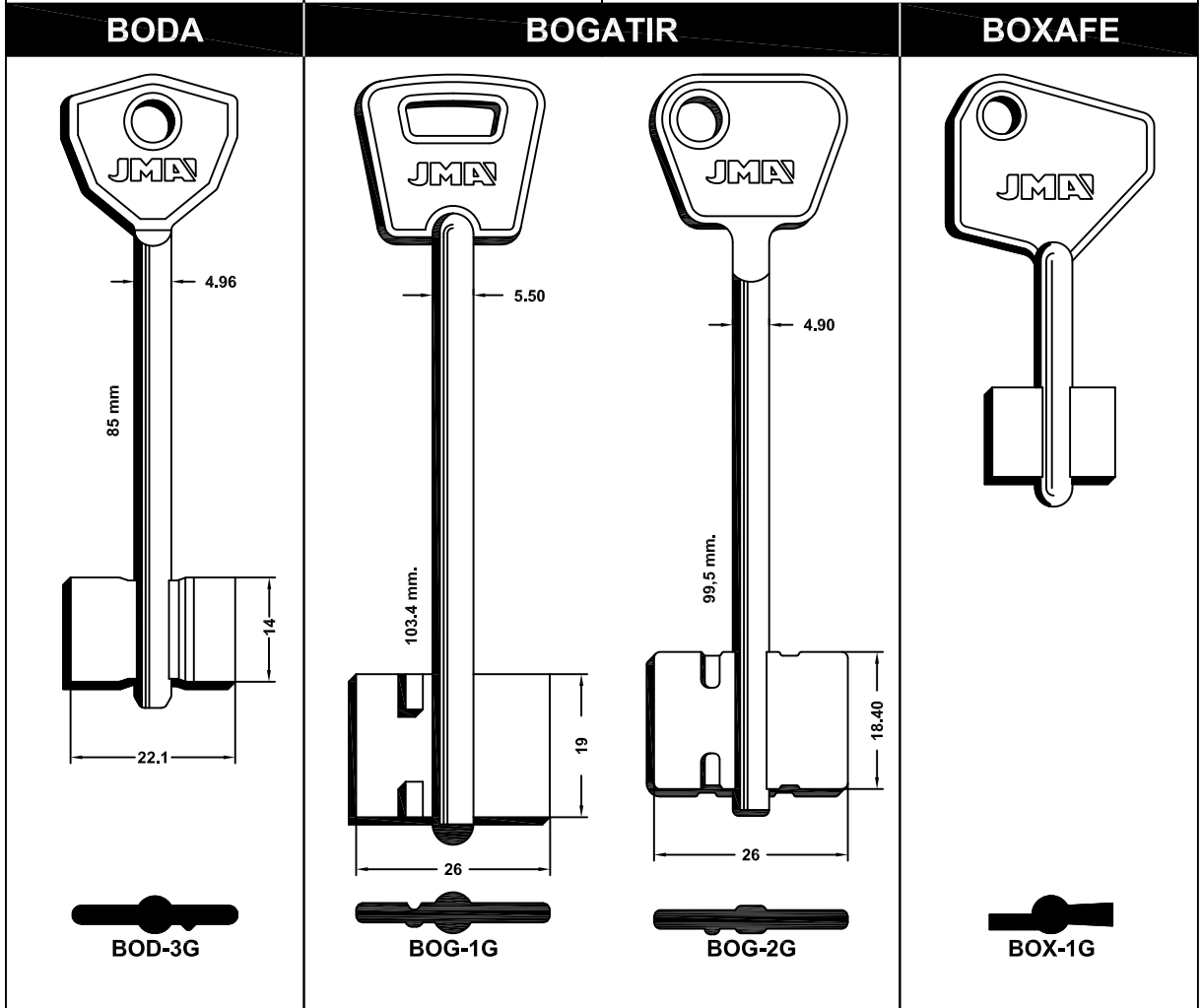

PARA-FOR:

CAF (I)

CERUTTI (I)

CAF

CERUTTI

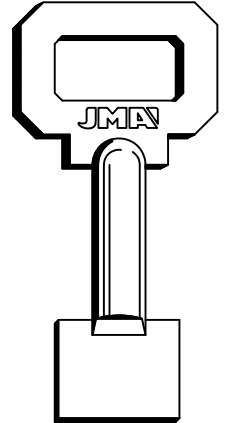
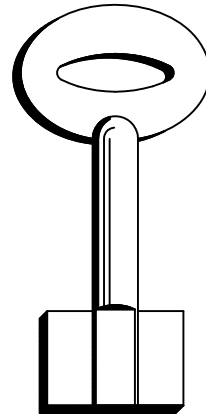
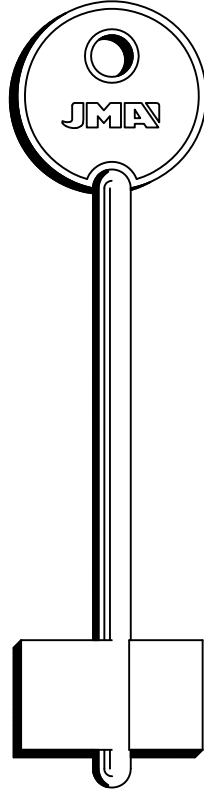
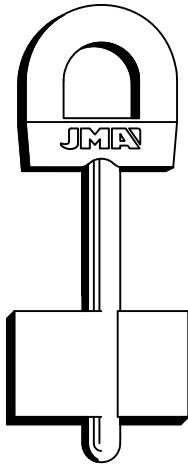

CAF-1G



CAF-2G



CRT-1G



CRT-2G

CERUTTI

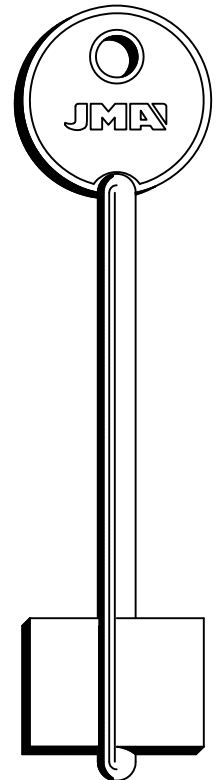
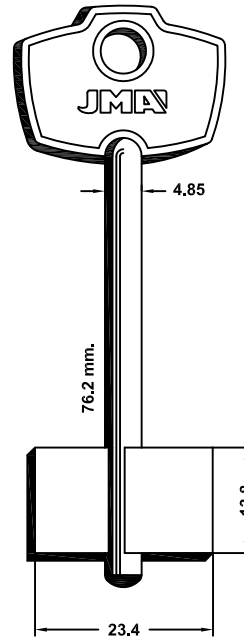
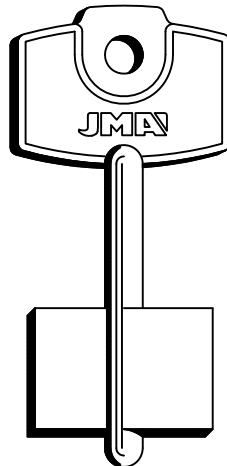
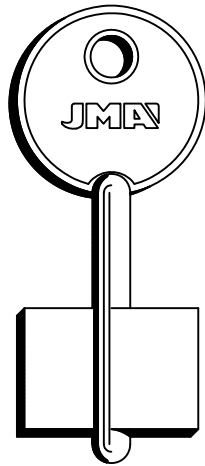

CRT-3G



CRT-4G



CRT-7G



CRT-8G



CERUTTI

PARA-FOR:

CERUTTI (I)

CHUBB (GB)

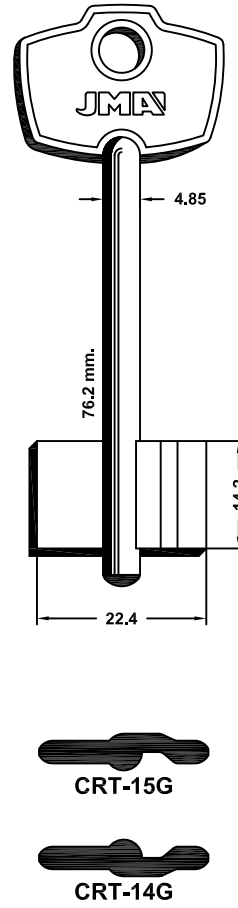
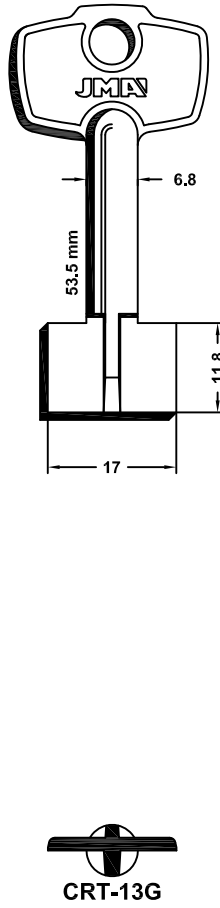
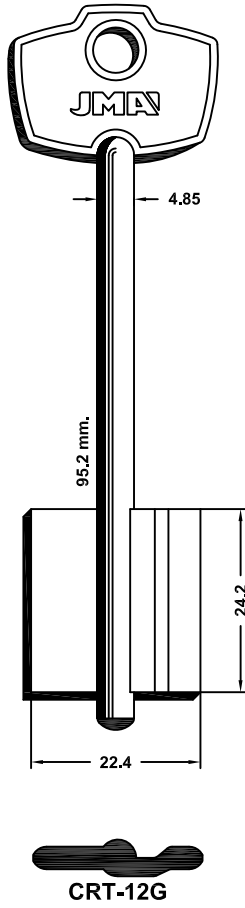
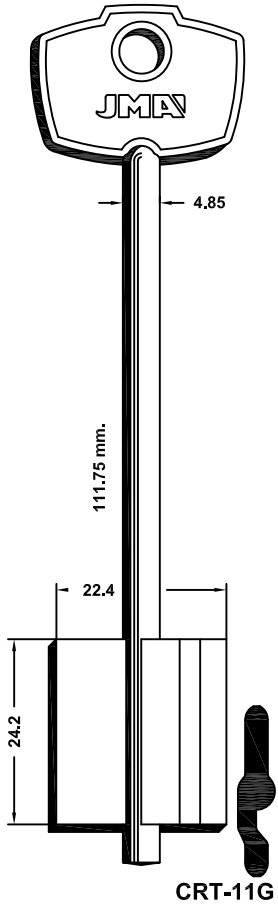

CERUTTI

CHUBB

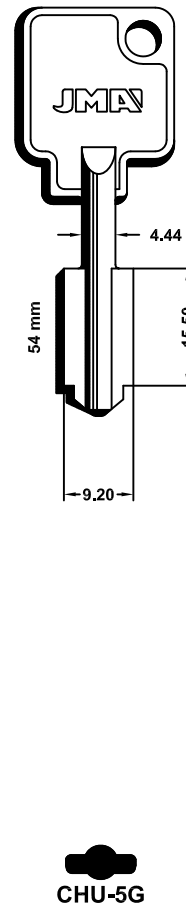
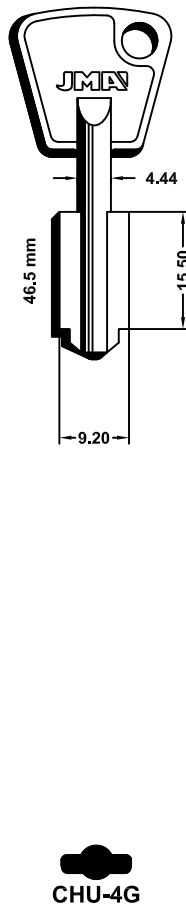
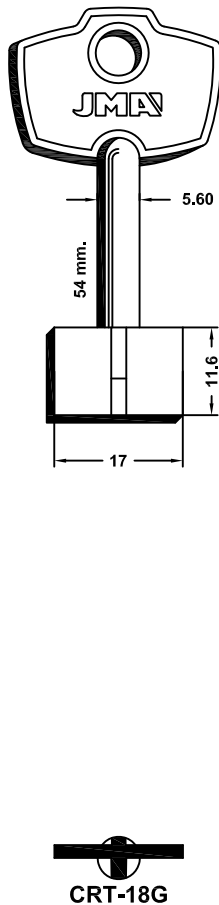
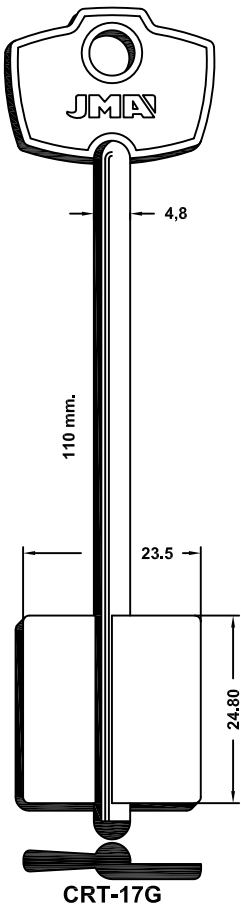

PARA-FOR:

CISA (I)

CISA

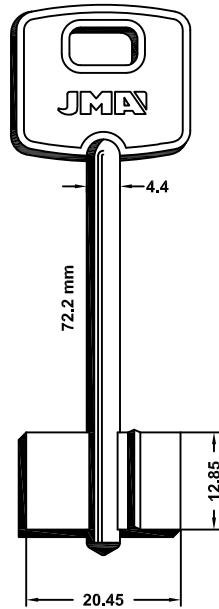

CI-1G



CI-2G

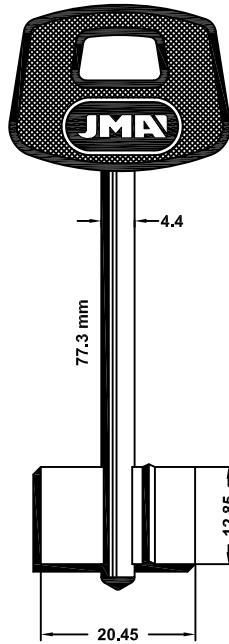

CI-1PG

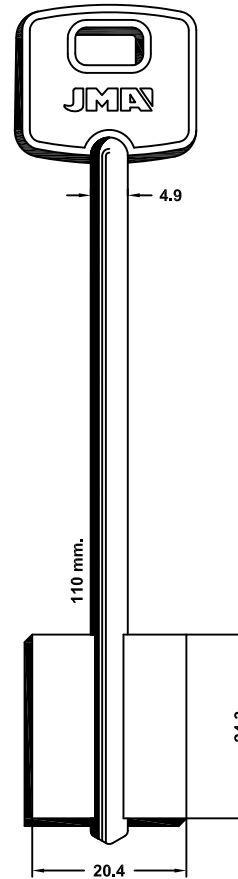

CI-3G



CI-4G

CISA

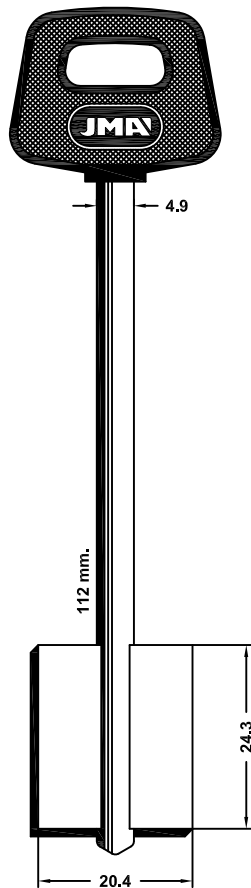

CI-3PG

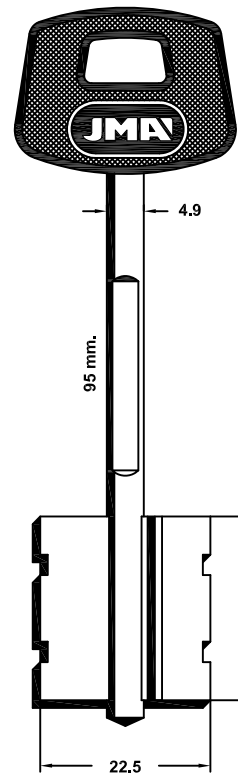

CI-5PG

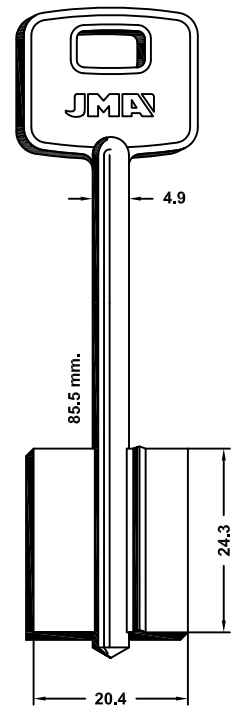

CI-6G



CI-10G



CISA

PARA-FOR:

CISA (I)

CLASS (RUS)

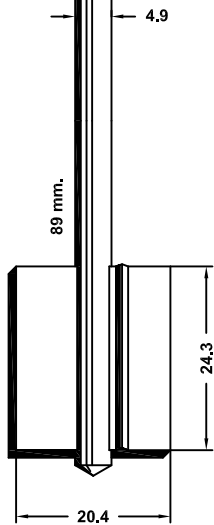

CI-6PG

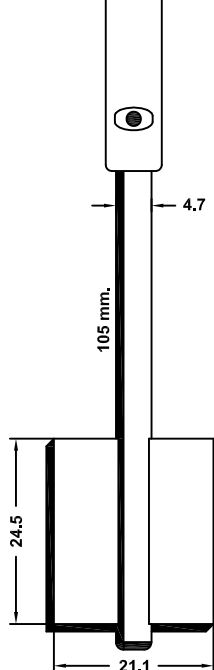
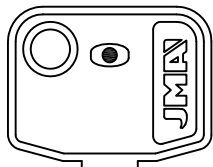

CI-7TG



CI-12TG

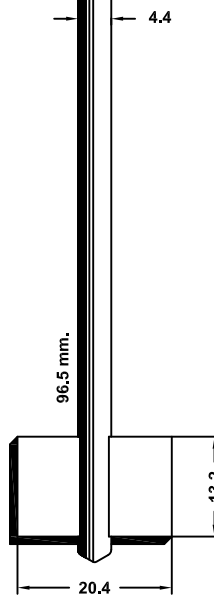
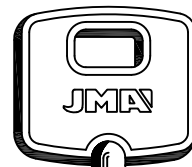

CI-8G

CISA

CLASS

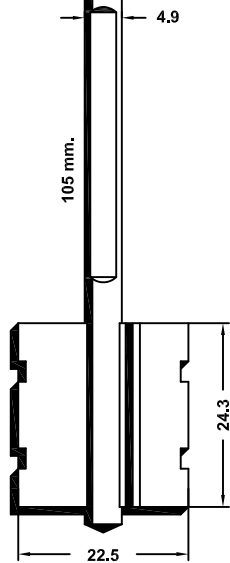

CI-9PG

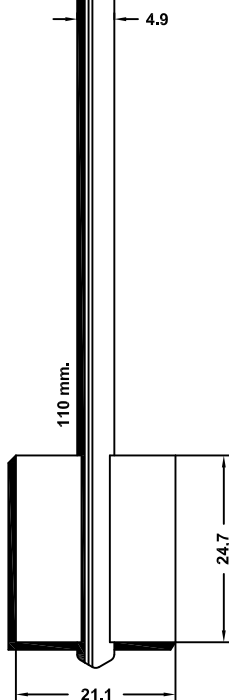
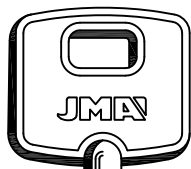

CI-13G



CI-14G

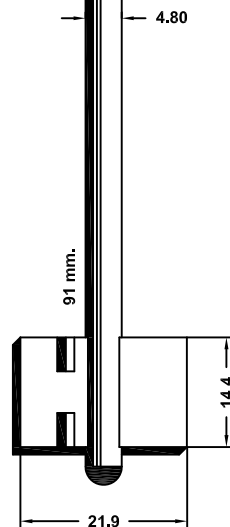
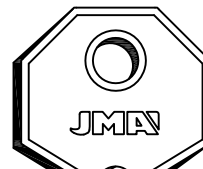

CLA-3G



PARA-FOR:

CORNI (I)

CR (I)

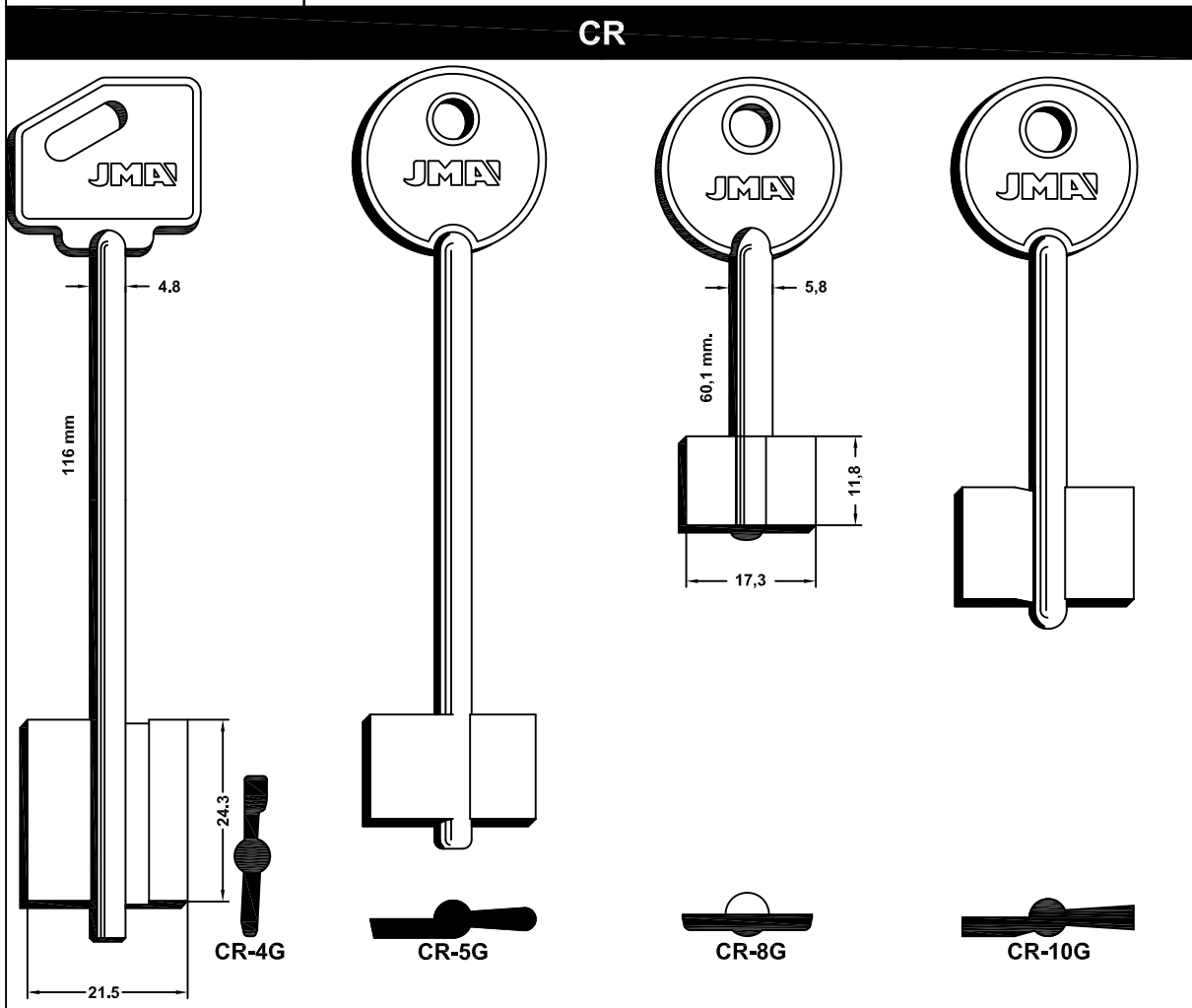
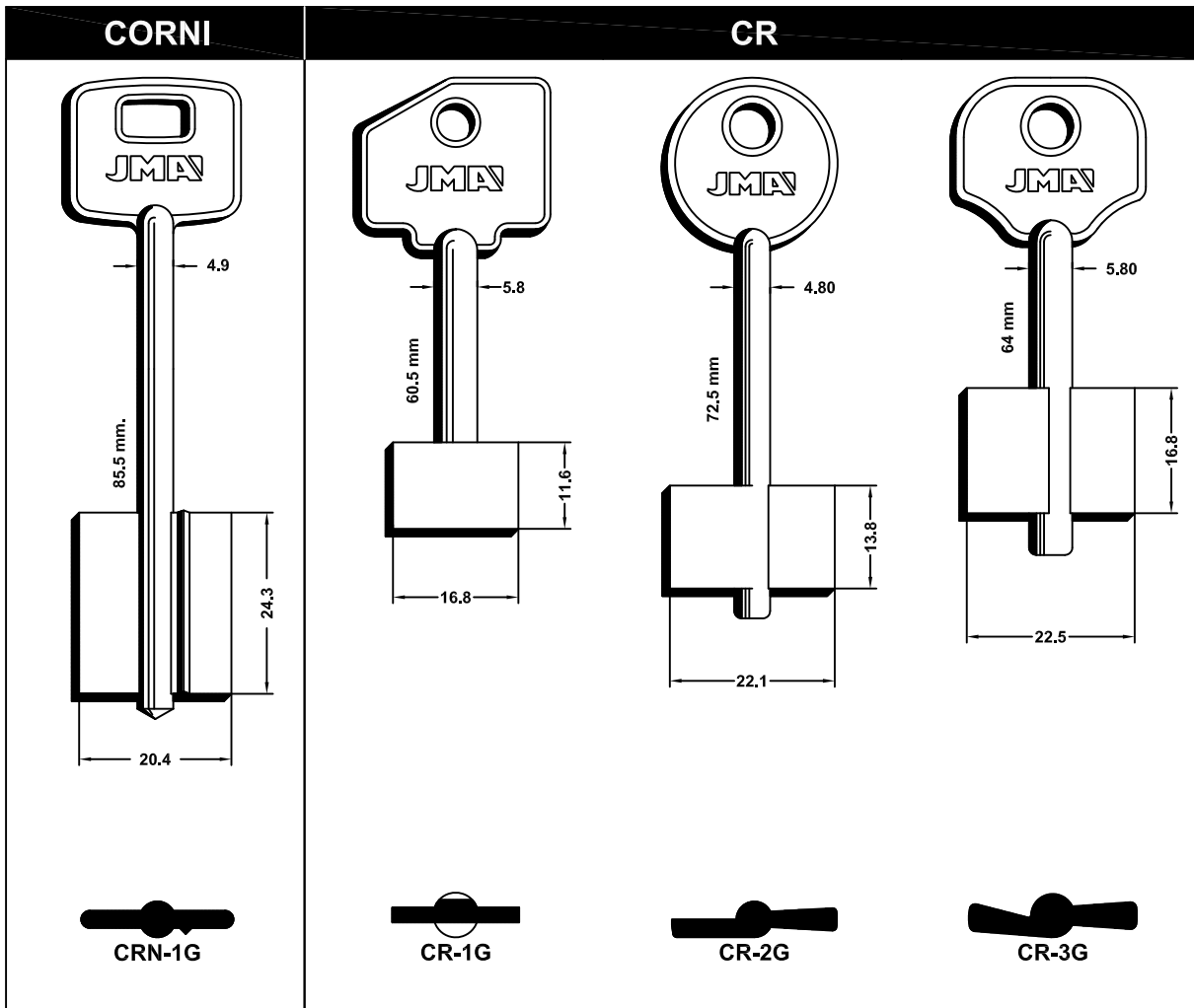

CR

PARA-FOR:

CR (I)

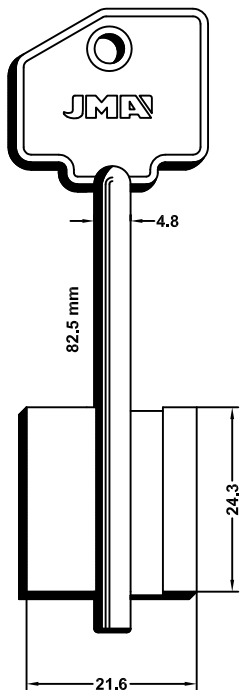

CR-11G

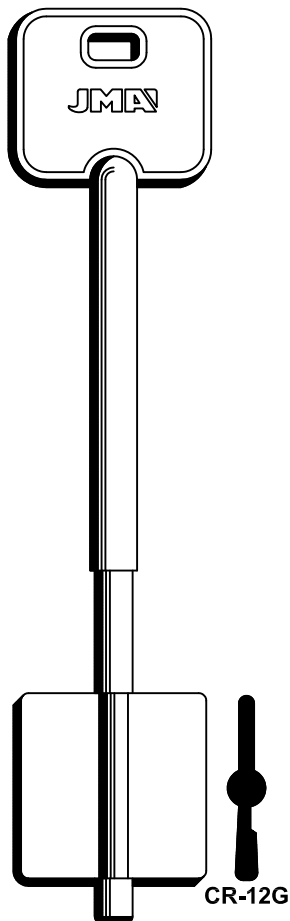

CR-12G

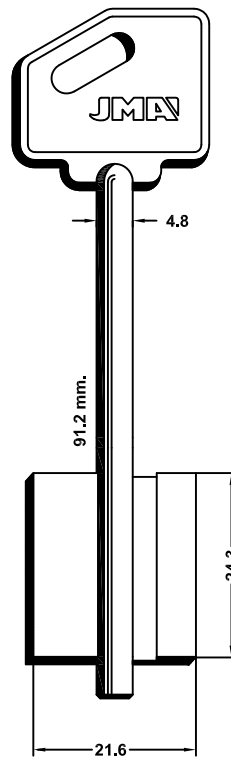

CR-14G

CR

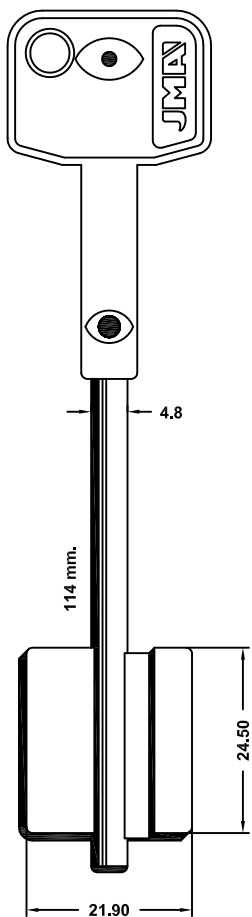

CR-17TG

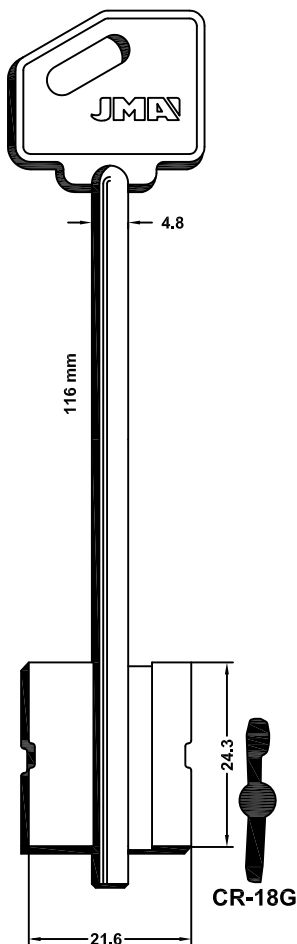

CR-18G

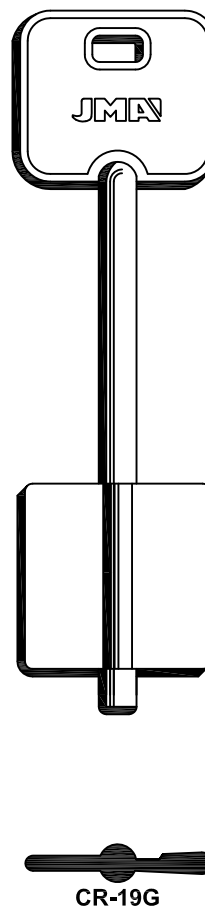

CR-19G



PARA-FOR:
 DEKABA (BG)
 DVERNIAK (RUS)

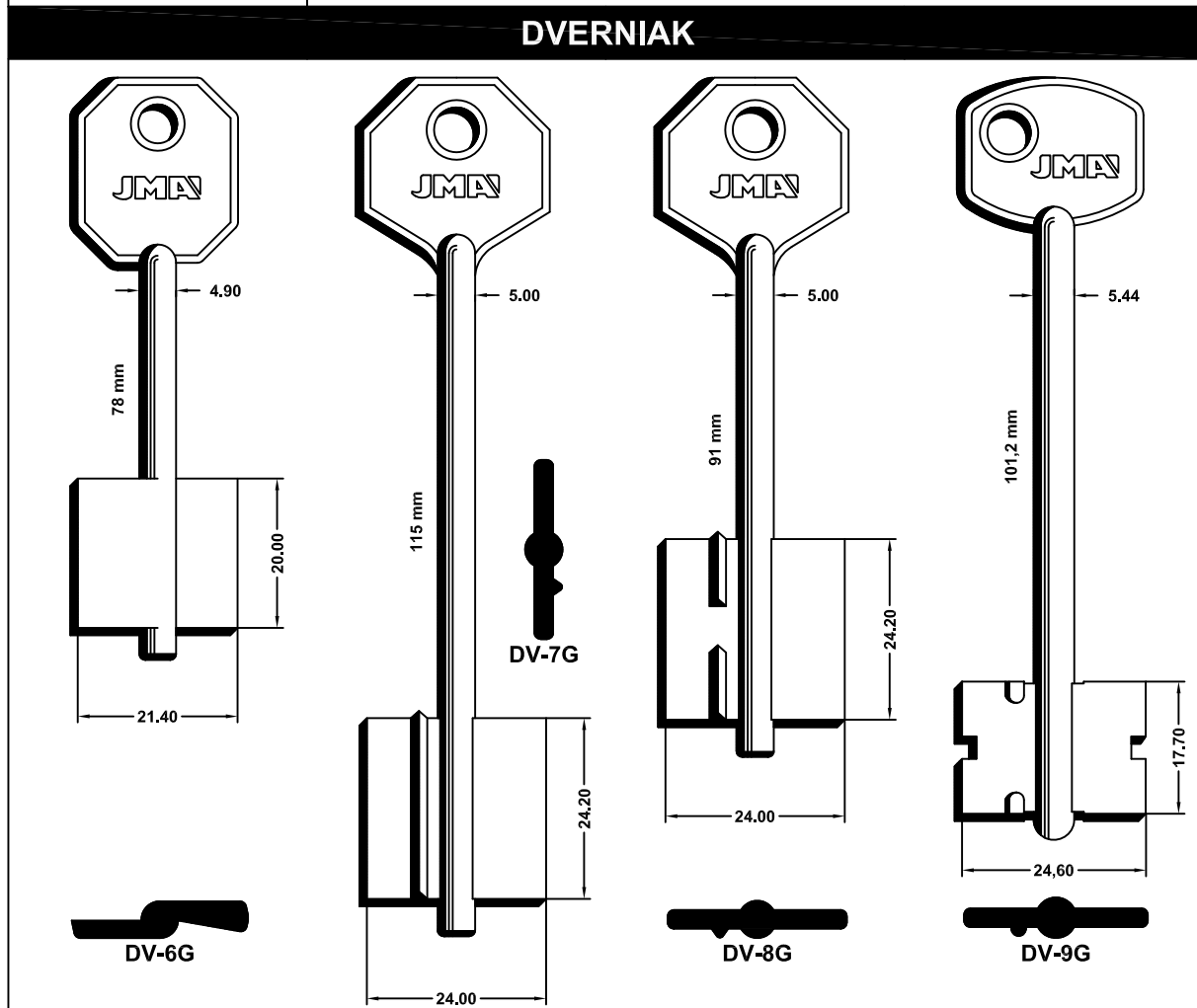
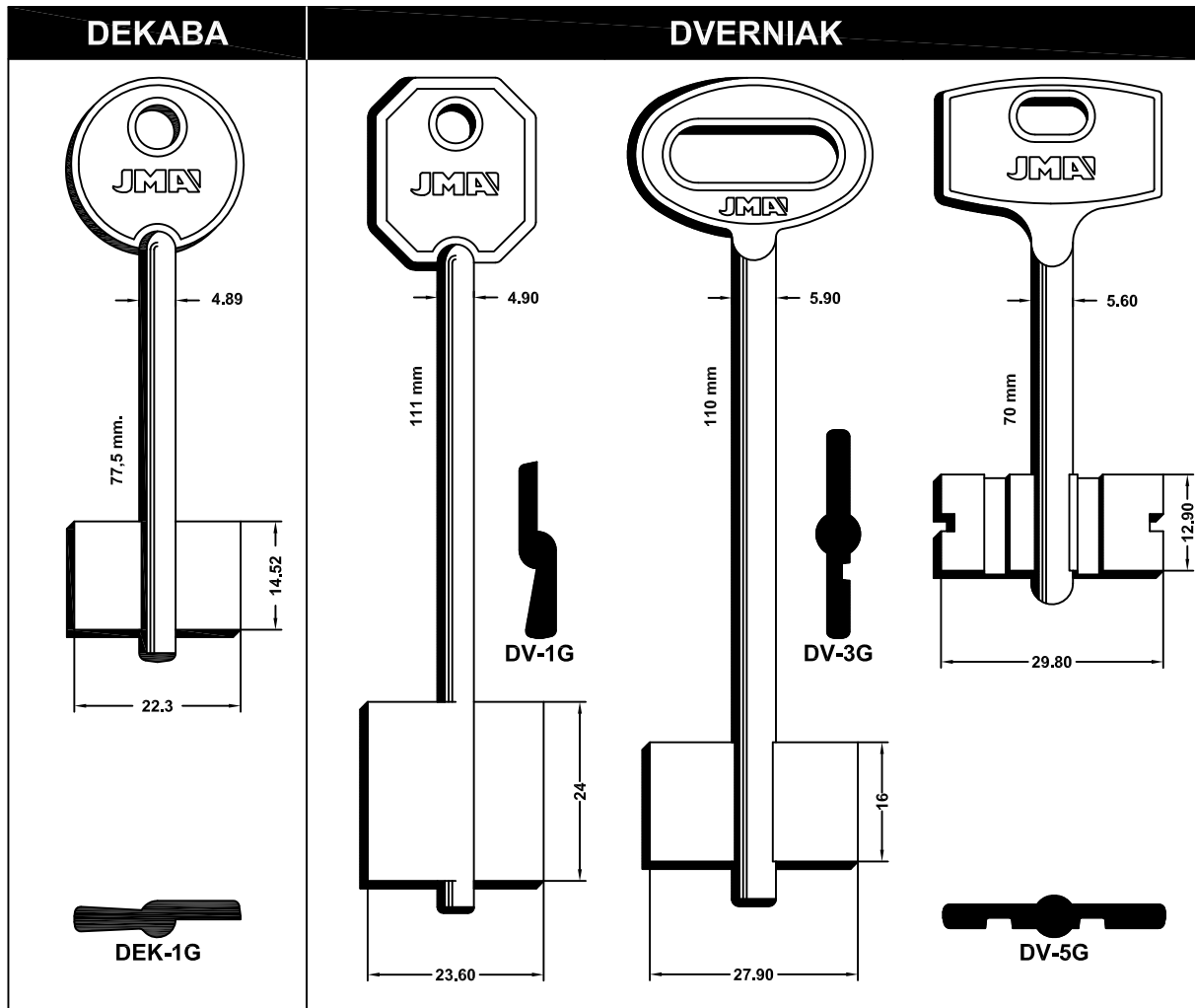

DVERNIAK

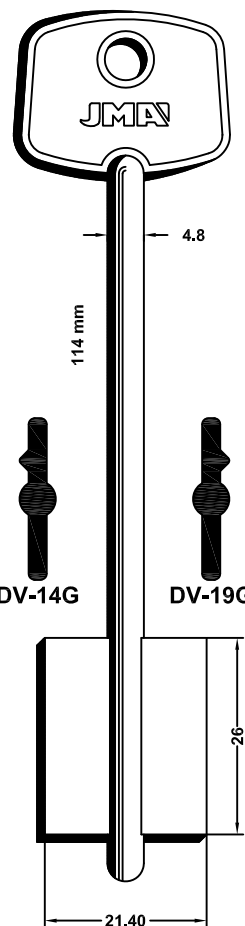
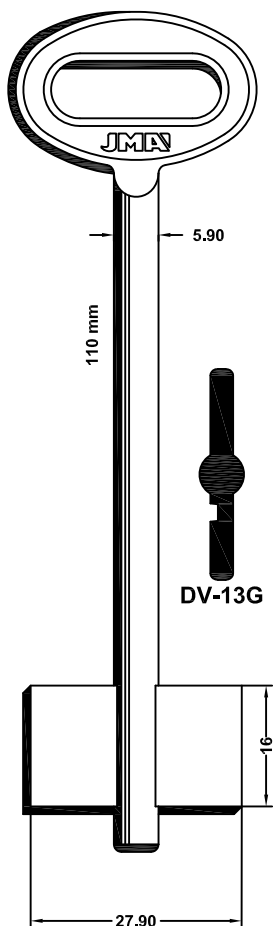
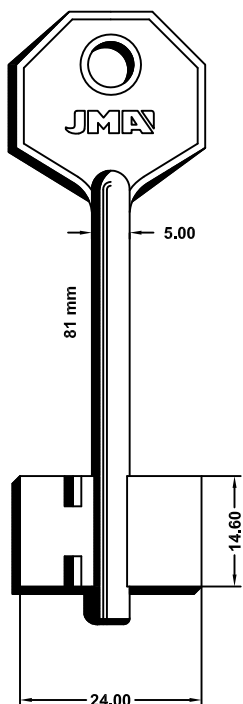
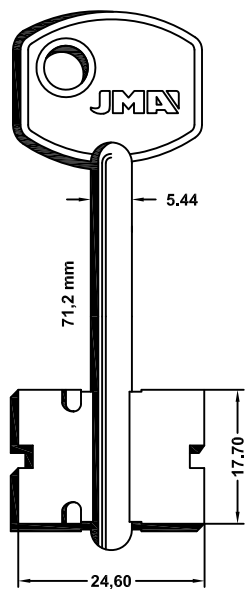

PARA-FOR:
DVERNIAK (RUS)
ELBOR (RUS)

DVERNIAK

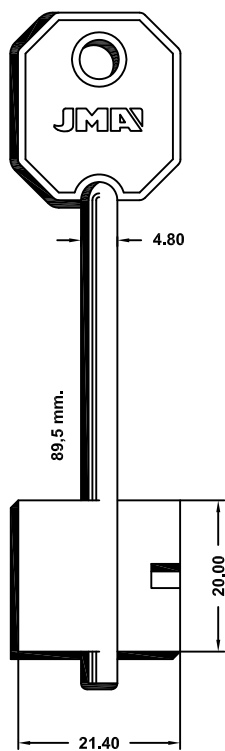
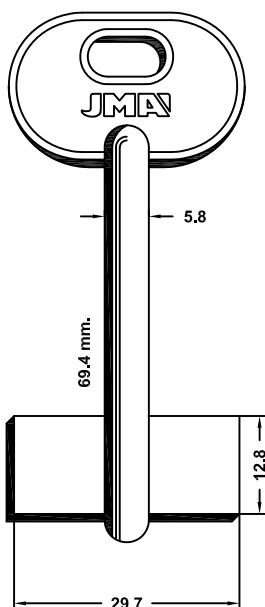
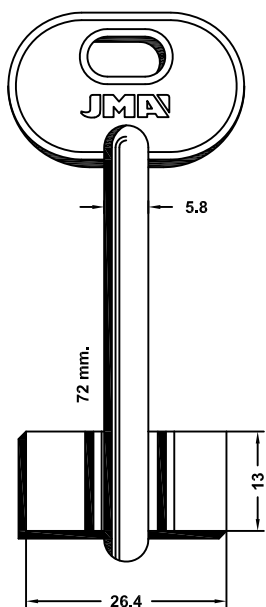

METTEM

ELBOR

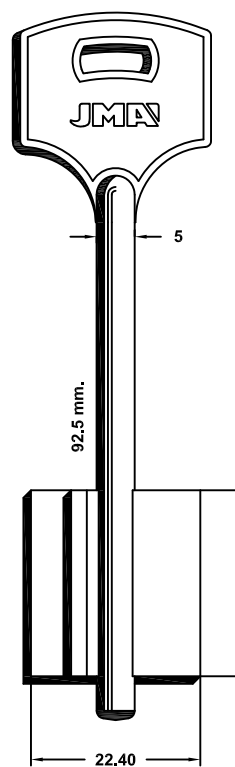

PARA-FOR:

ELZETT (H)
 EREVAN (RUS)
 ESETY (I)

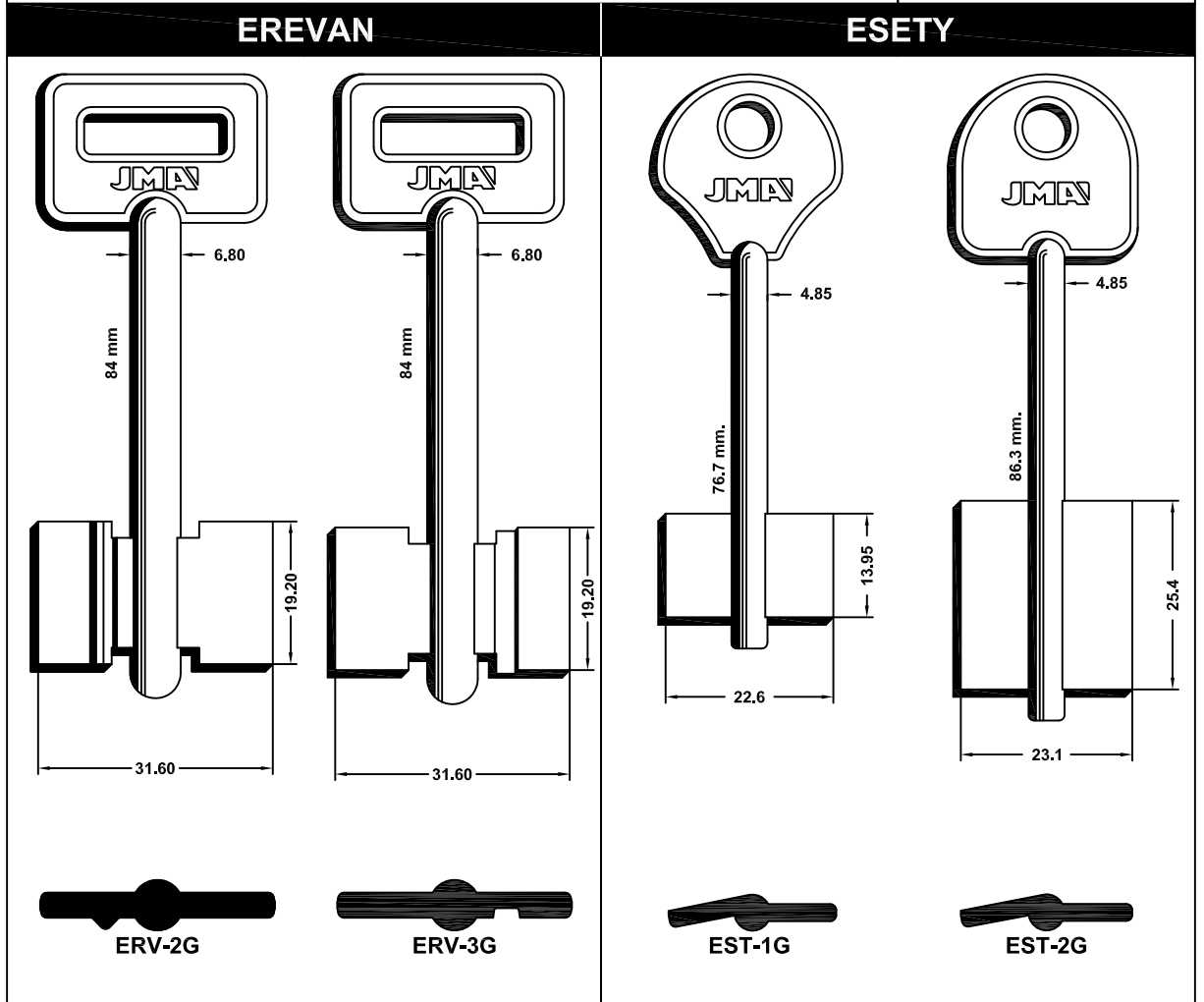
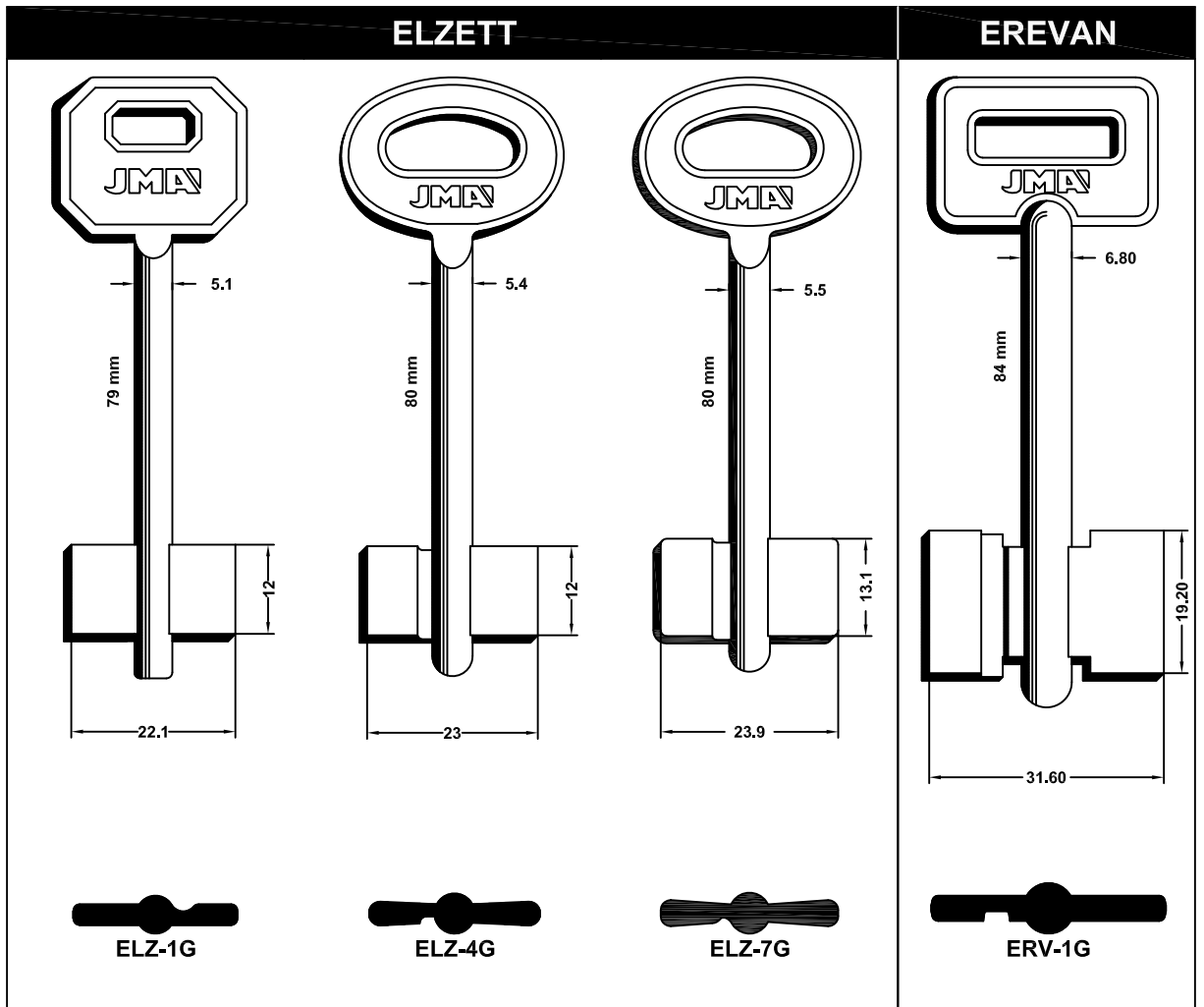

ESETY

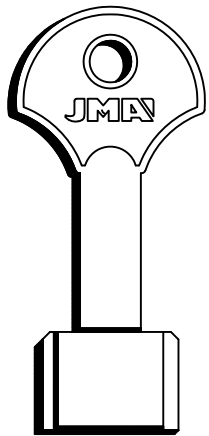

EST-3G

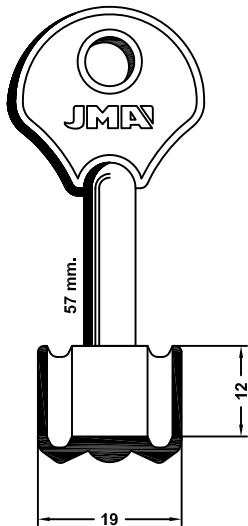

EST-4G

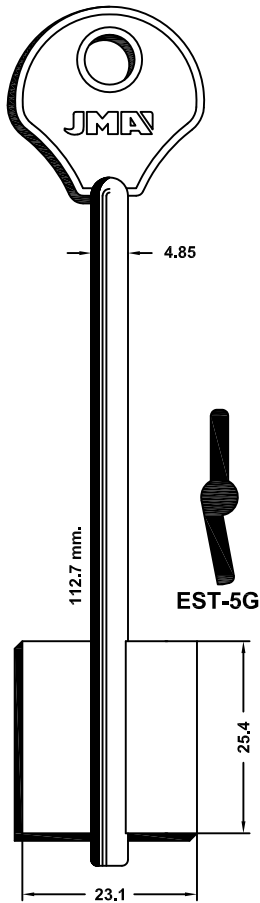

EST-5G

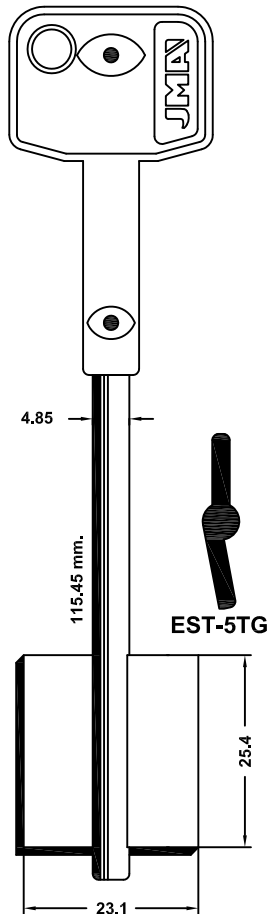

EST-5TG

PARA-FOR:

ESETY (I)

EUROTEMPLE (I)

ESETY

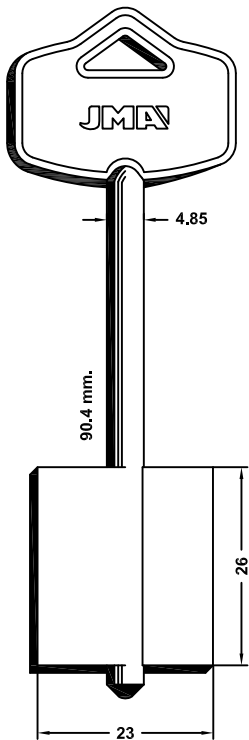

EST-6G

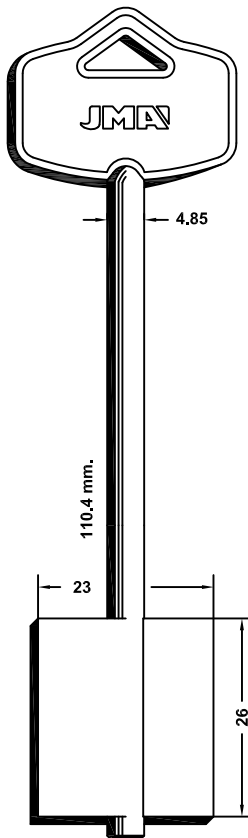

EST-7G

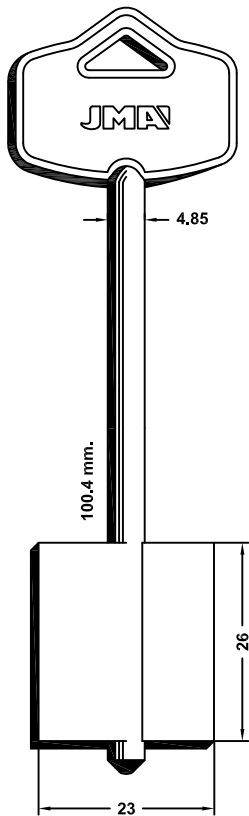

EST-10G

EUROTEMPLE

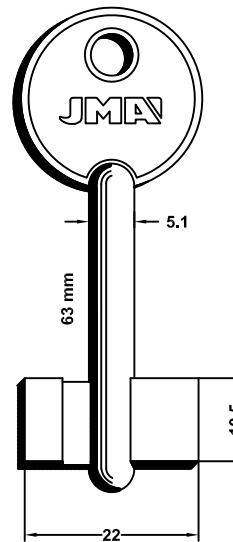

EUT-1G

SAG



PARA-FOR:
 EUROTÉMPLE (I)
 EZCURRA (E)

EUROTÉMPLE

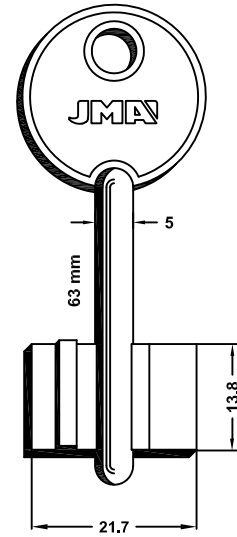
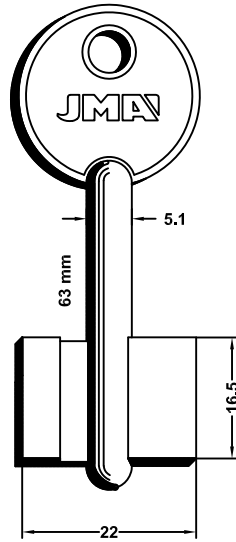

EUT-2G

SAG



EUT-3G

EZCURRA

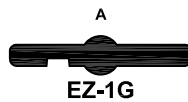
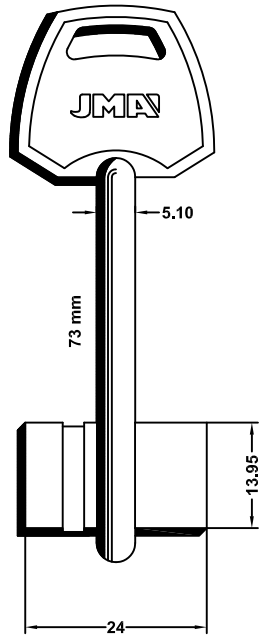

EZ-1G

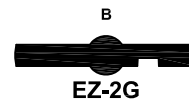

EZ-2G

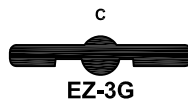

EZ-3G

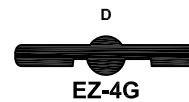

EZ-4G

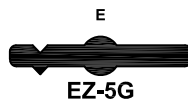

EZ-5G

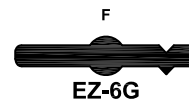

EZ-6G

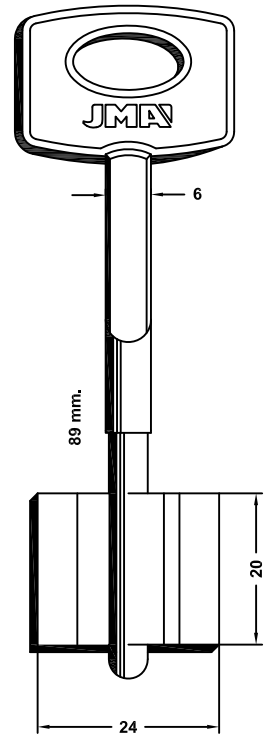

EZ-7G



EZCURRA

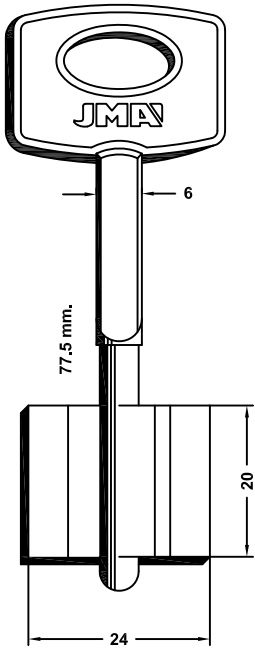

FAC

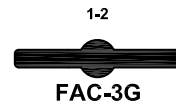
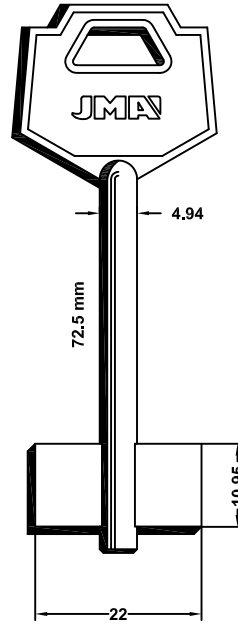
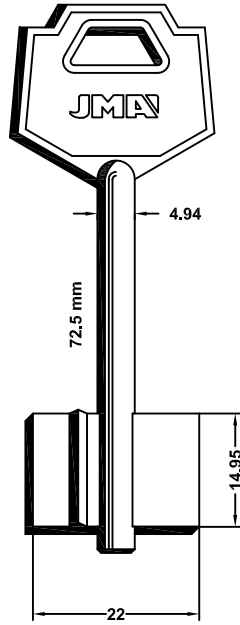
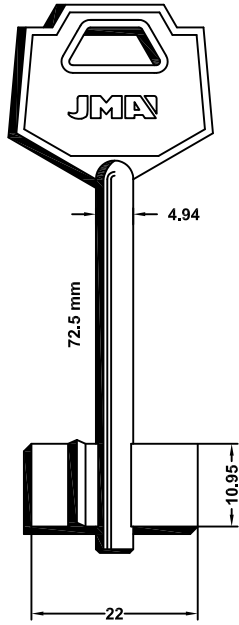

PARA-FOR:

EZCURRA (E)

FAC (E)

FEB (I)

FETIS (E)

FAC

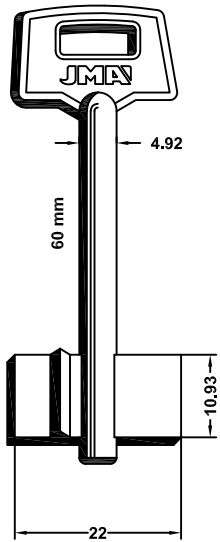

FEB

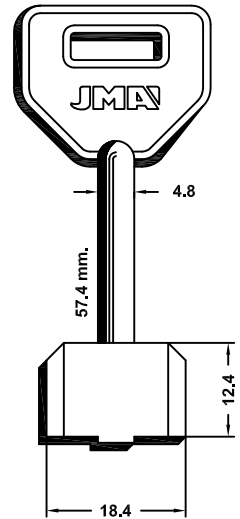
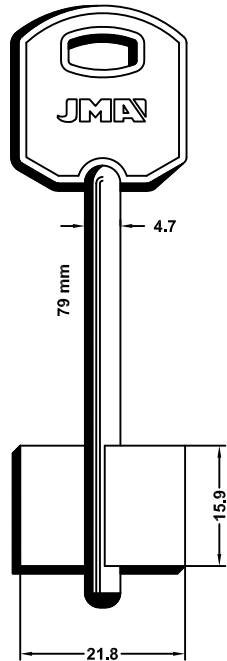

FETIS

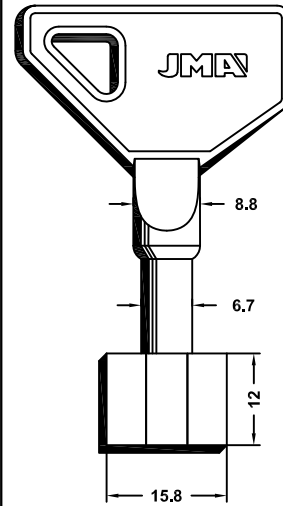

PARA-FOR:

FIAM (I)

FIAM

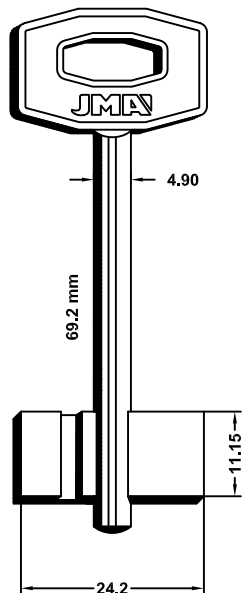

FM-1G

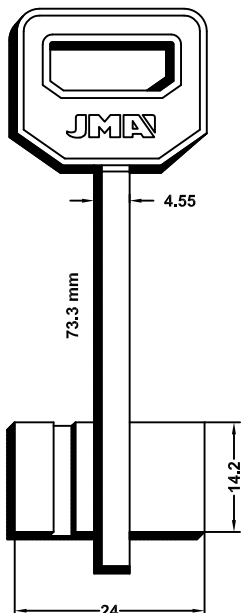

FM-2G

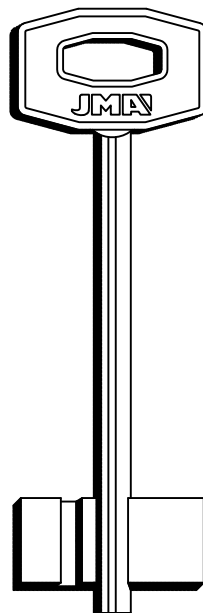

FM-3G

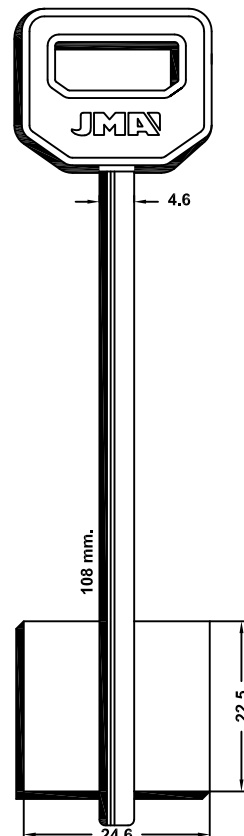

FM-4G

FIAM

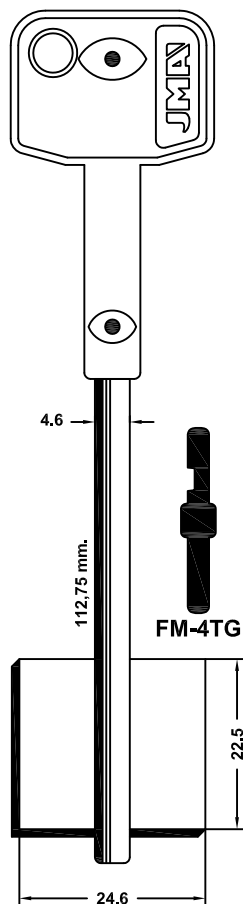

FM-4TG

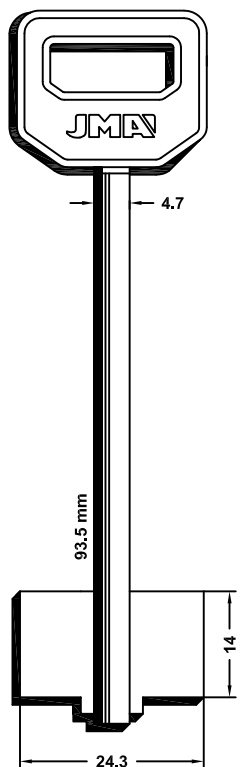

FM-5G

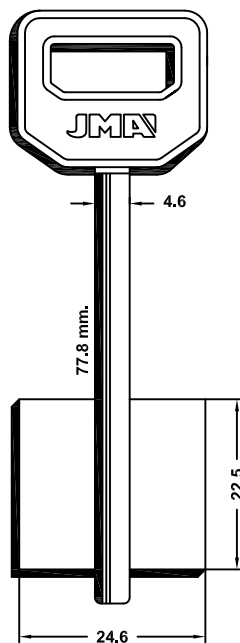

FM-6G

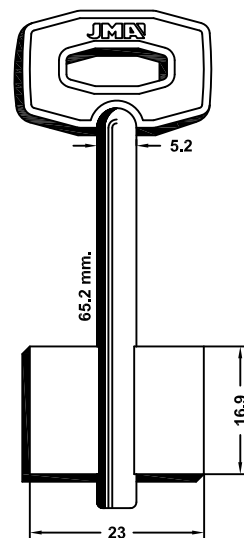

FM-7G



FIAM

PARA-FOR:

FIAM (I)

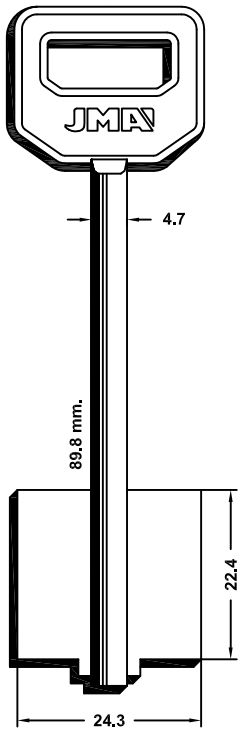

FM-8G

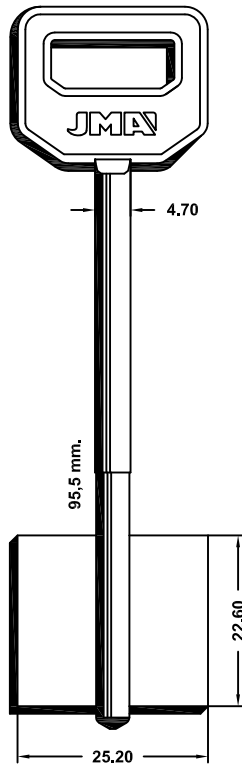

FM-13G

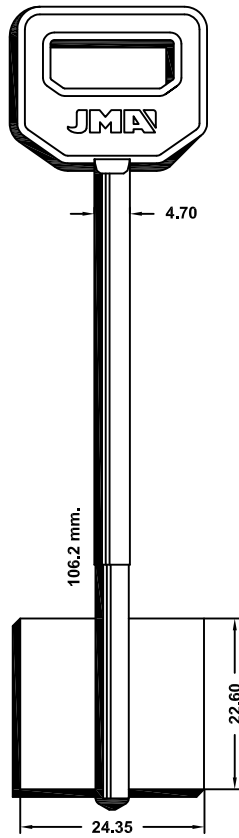

FM-14G

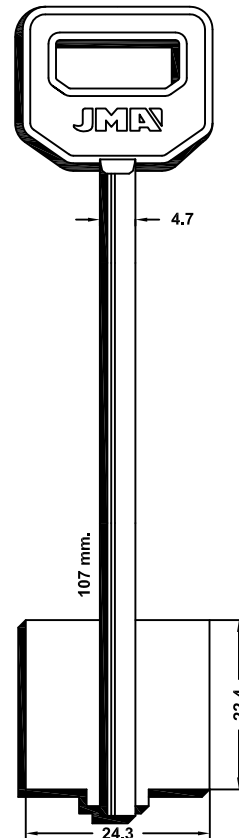

FM-15G

FIAM

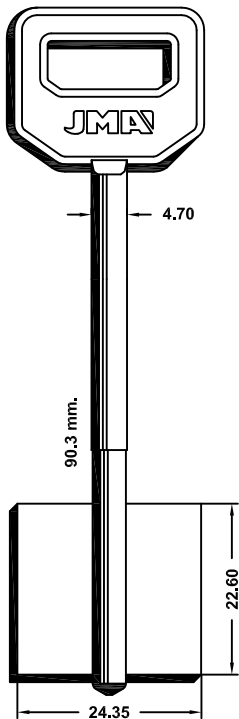

FM-16G

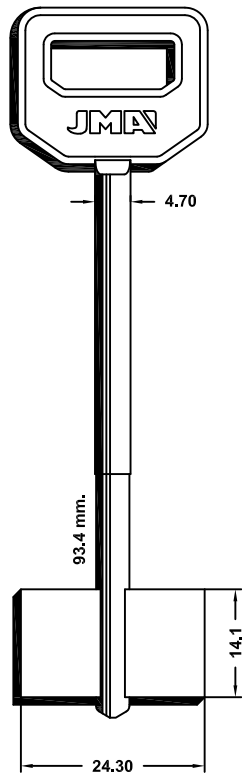

FM-17G

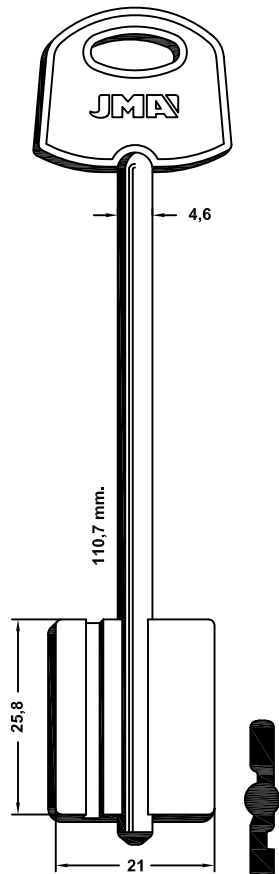

FM-20G

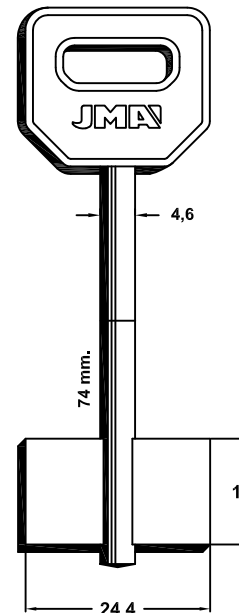

FM-21G

ISEO



PARA-FOR:

- FICHET (F)
- GARDIAN (RUS)
- GIMAST (I)
- GIPIS (I)
- GMG (I)

	FICHET	GARDIAN	GIMAST	
	<p>FIC-200</p>	<p>GARD-1G</p>	<p>GIM-1TG</p>	
	GIPIS		GMG	
	<p>GPS-1G</p>	<p>GPS-2G</p>	<p>GMG-1G</p>	<p>GMG-2G</p>



IDM

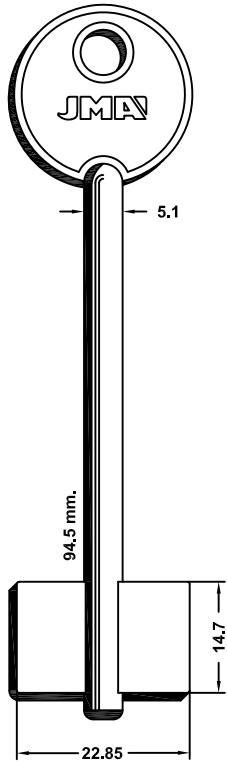

IDM-1G

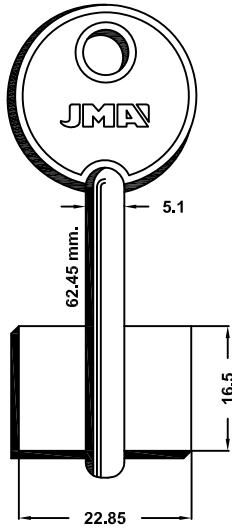

IDM-2G

SAG

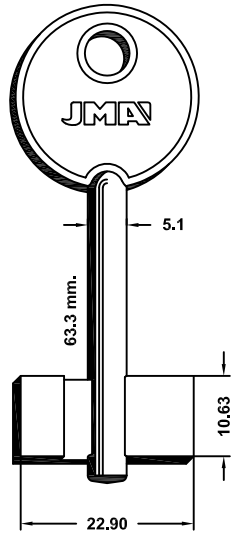

IDM-3G

SAG

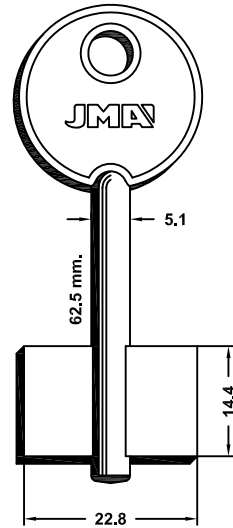

IDM-4G

PARA-FOR:

IDM (I)

ISEO (I)

IDM

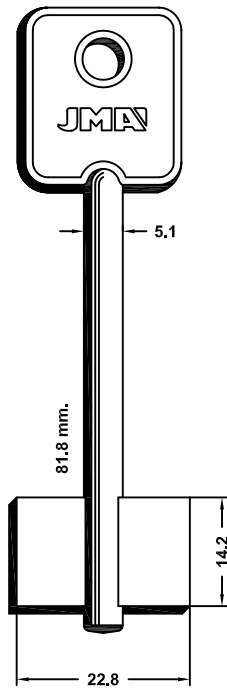

IDM-5G

FACEF-DOMUS

ISEO

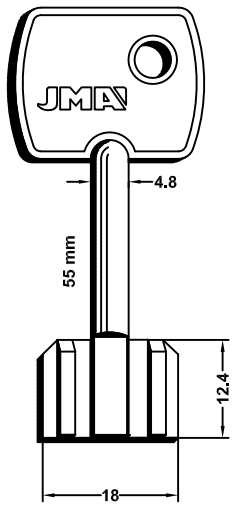

IS-1G

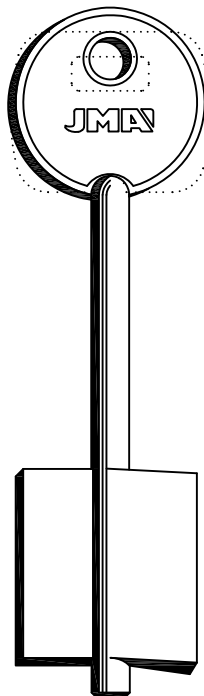

IS-2G

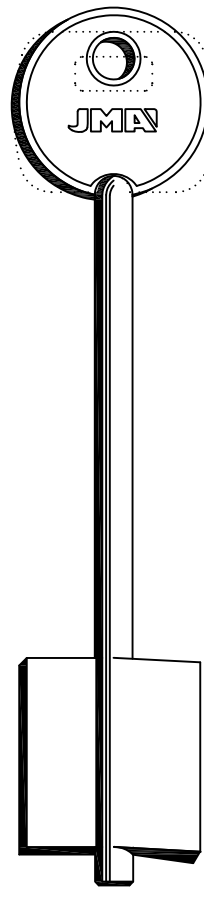

IS-3G



PARA-FOR:

ISEO (I)

ITAL (I)

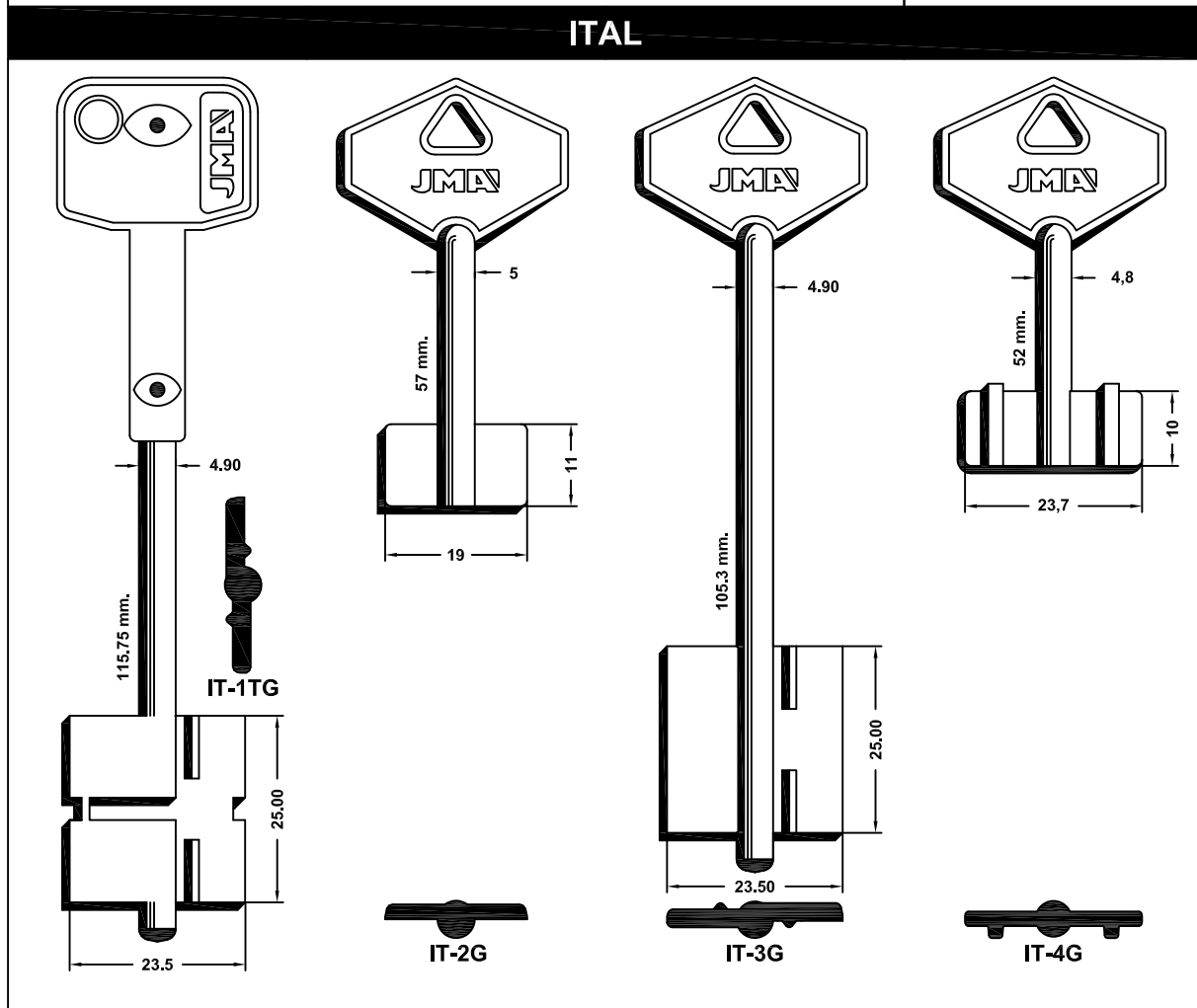
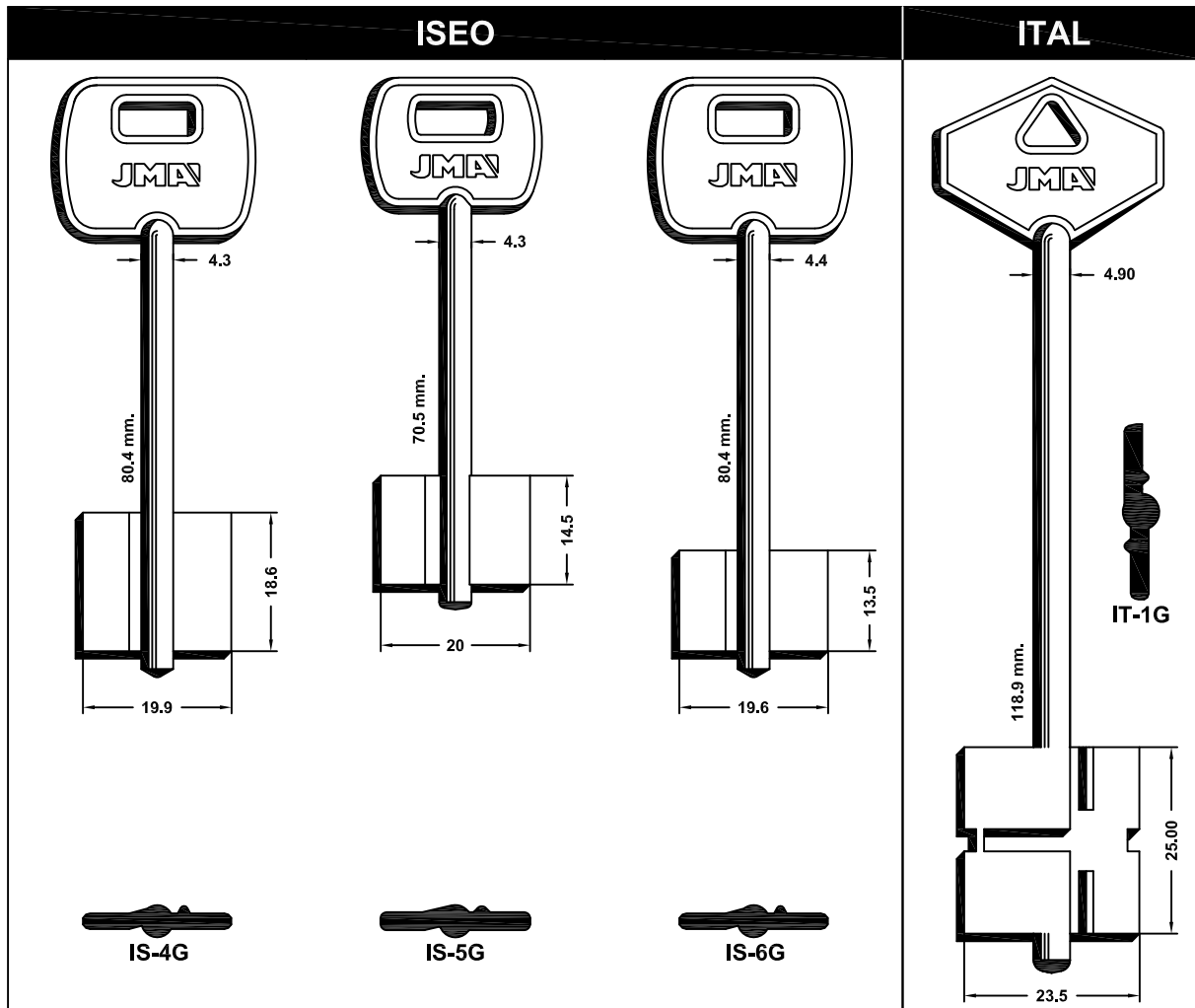

JUWEL

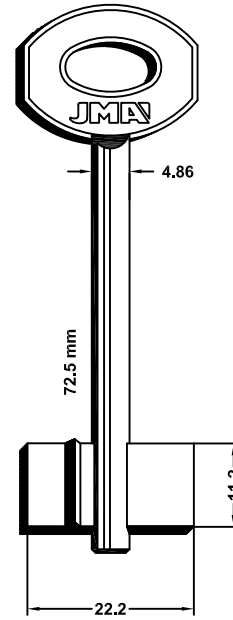
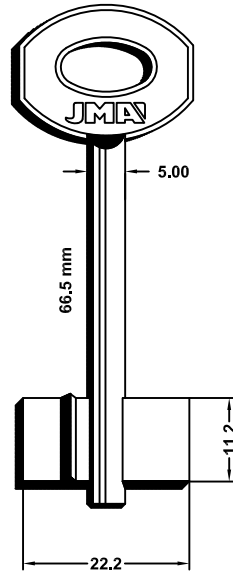
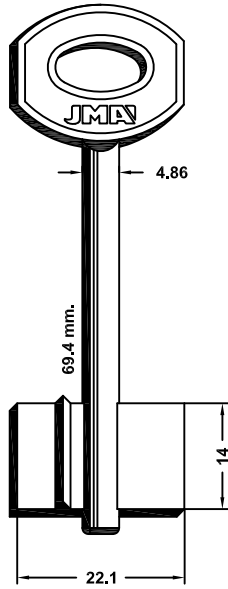
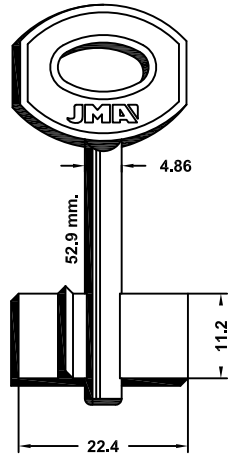

JW-20G

BURG-WACHTER



JW-30G

BURG-WACHTER



JW-40G

BURG-WACHTER



JW-45G

BURG-WACHTER

JUWEL

KALE

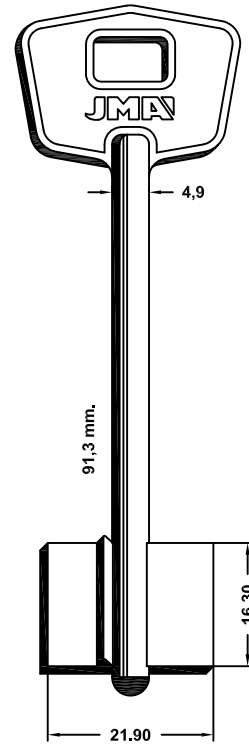
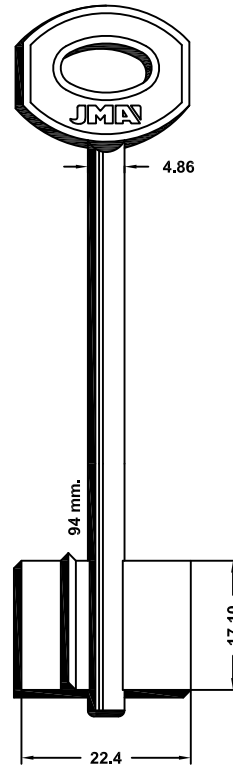
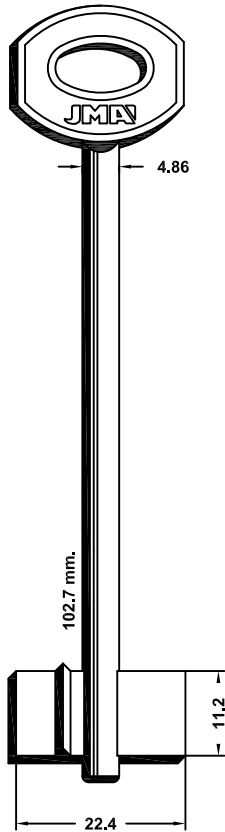
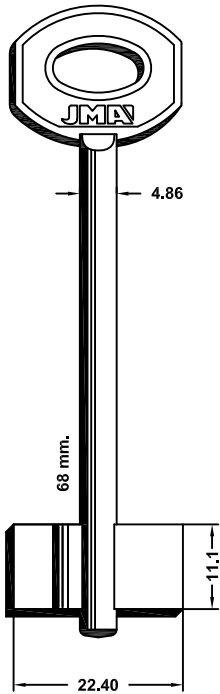

JW-50G



JW-70G

BURG-WACHTER



JW-90G



KAE-1G

PARA-FOR:

JUWEL (I)

KALE (TR)



PARA-FOR:

KASSEL (I)

KERBEROS (RUS)

KASSEL

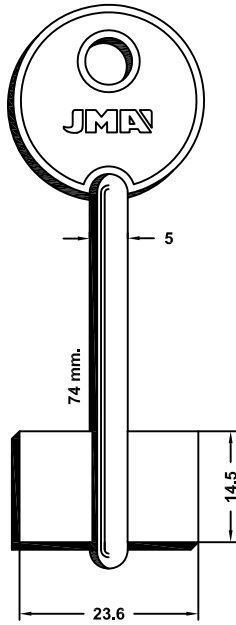

KAS-1G

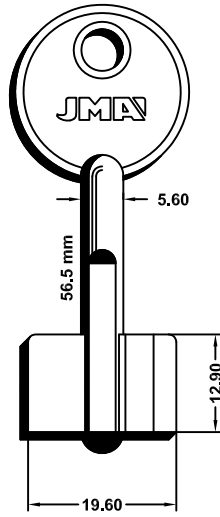

KAS-2G

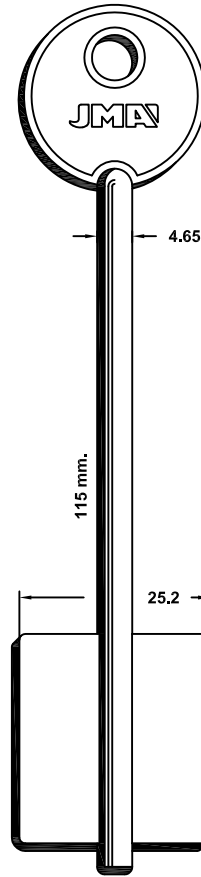

KAS-4G

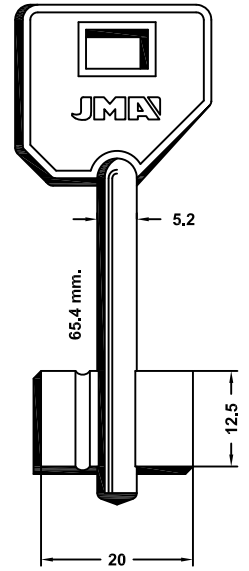

KAS-6G

KERBEROS

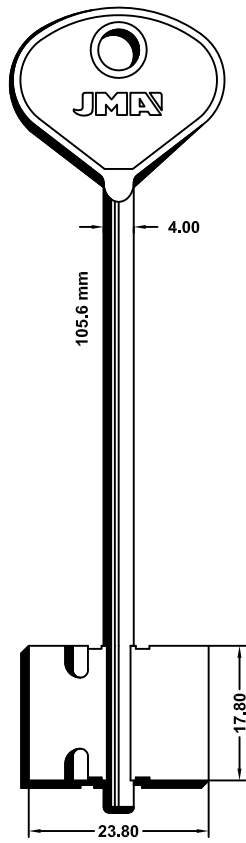

CER-1G

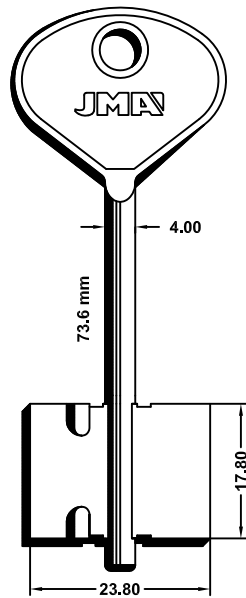

CER-2G

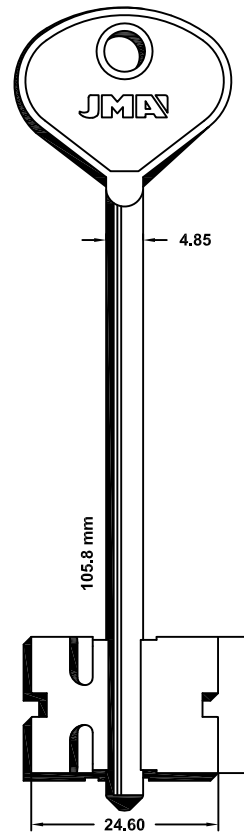

CER-3G

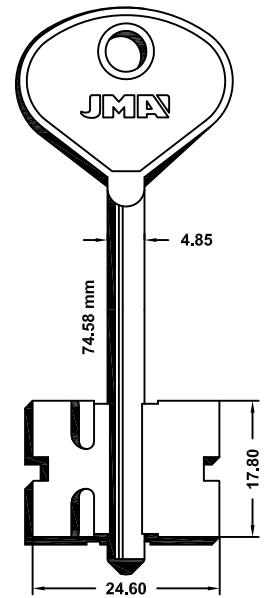

CER-4G

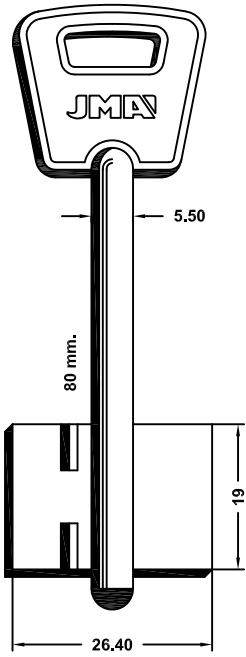
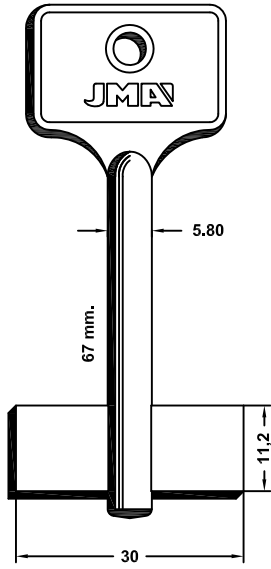
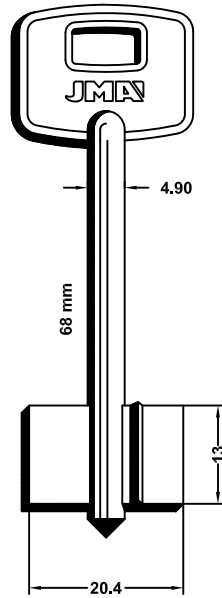
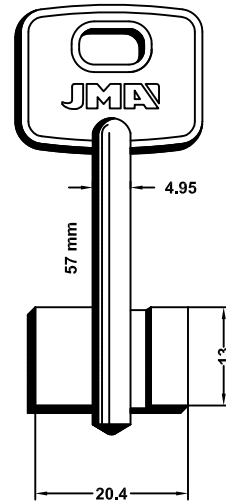

KREPISH**KRP-1G****KURZEME****KUR-1G****LINCE****LIN-2G****LIN-3G****PARA-FOR:**

KREPISH (RUS)
KURZEME (RUS)
LINCE (E)
MCM (E)
METAL (BG)

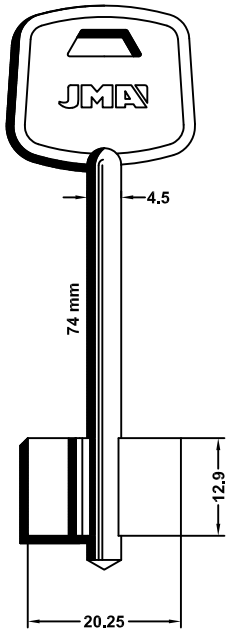
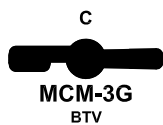
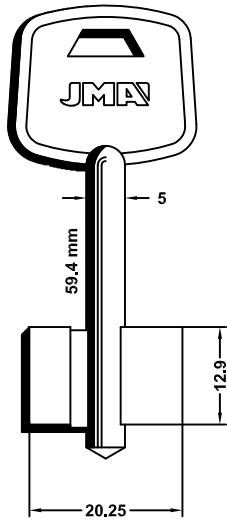
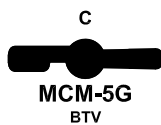
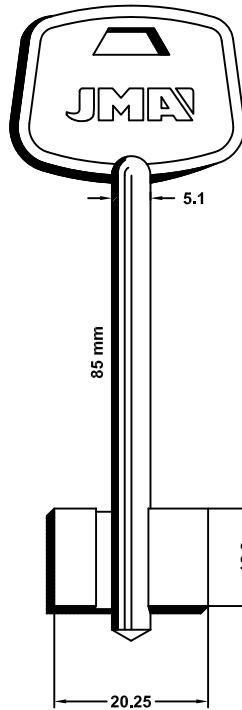
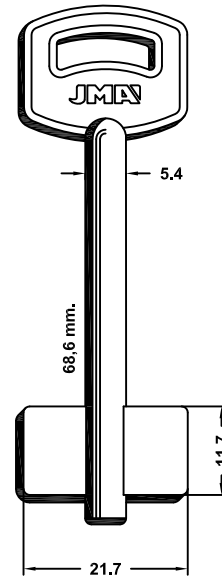
MCM**MCM-2G****MCM-3G**
BTV**MCM-5G**
BTV**METAL****MTL-1G**

PARA-FOR:

METAL (BG)

MOIA (I)

MOTTURA (I)

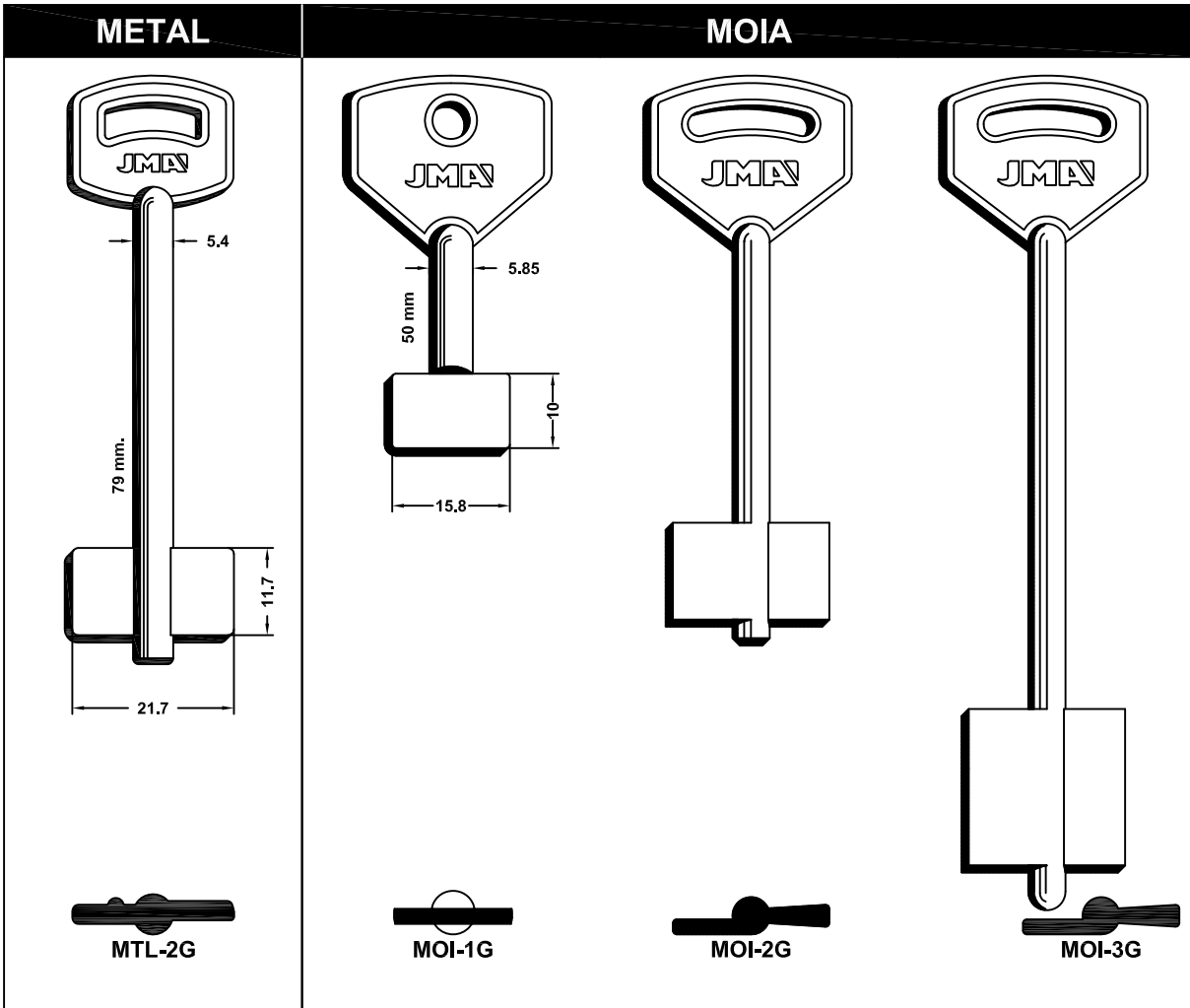

MOTTURA

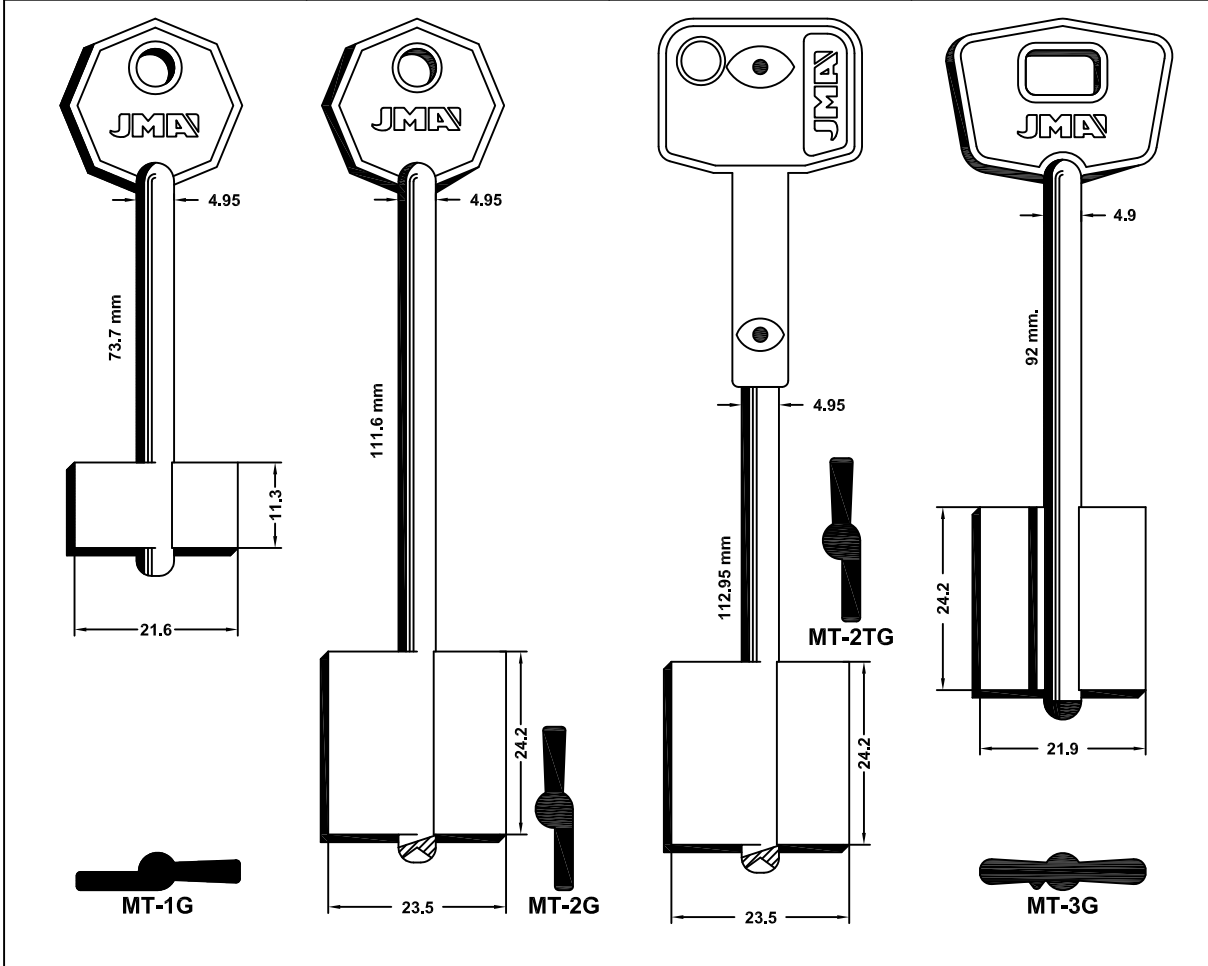

MOTTURA

PARA-FOR:
MOTTURA (I)

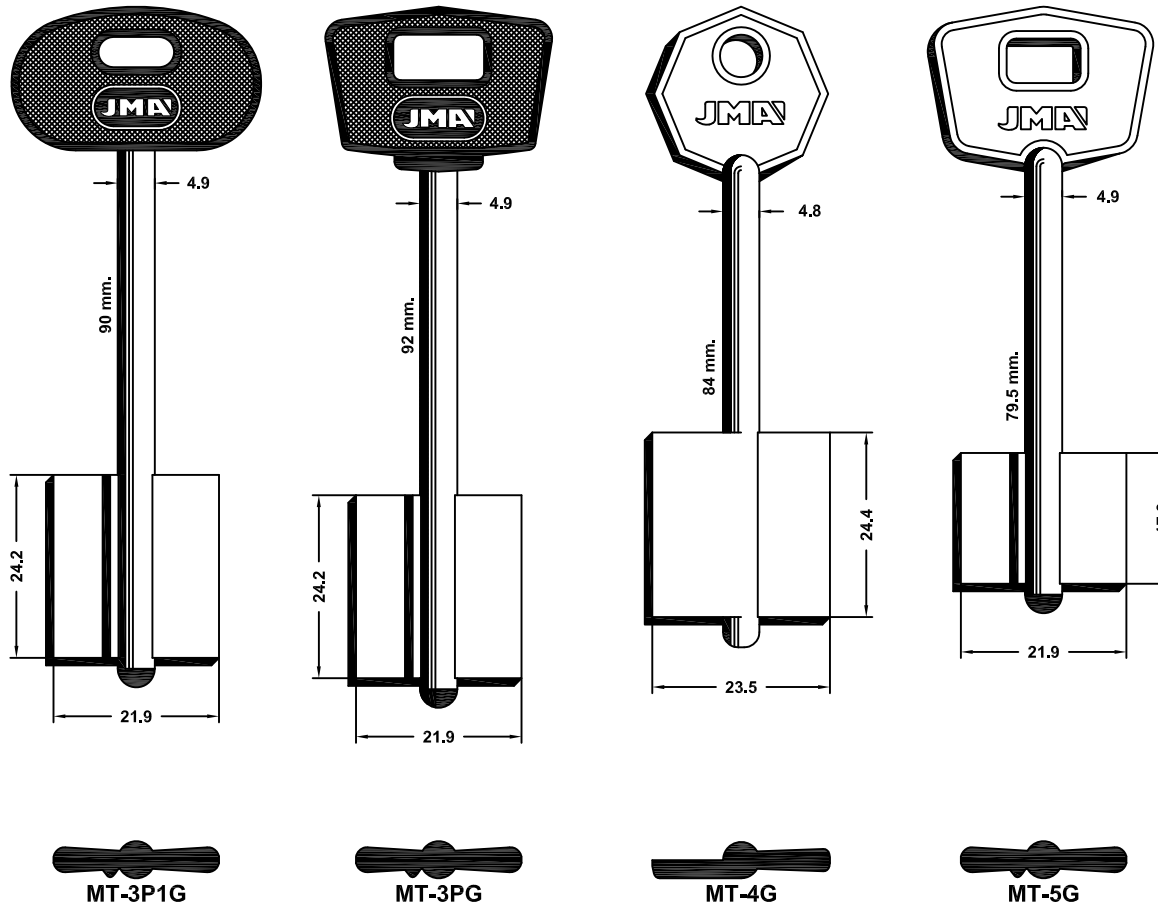

MOTTURA

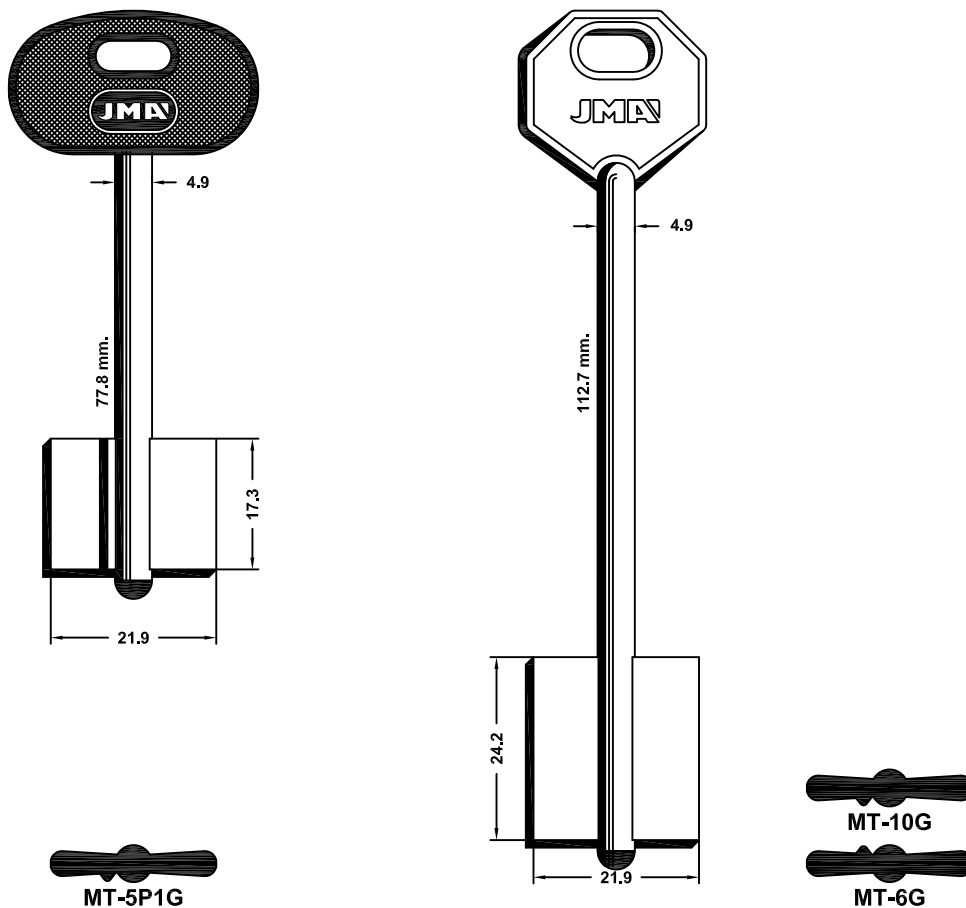

PARA-FOR:

MOTTURA (I)

MOTTURA

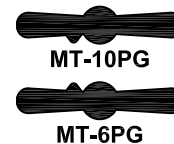
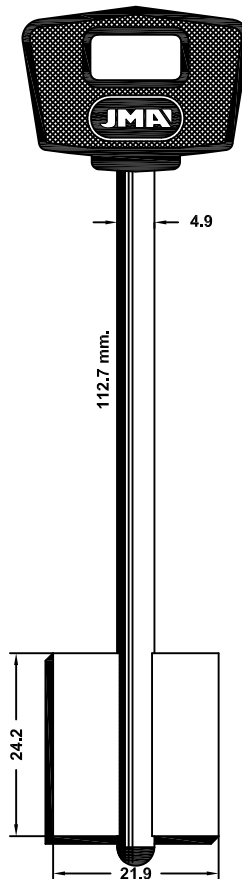
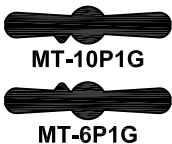
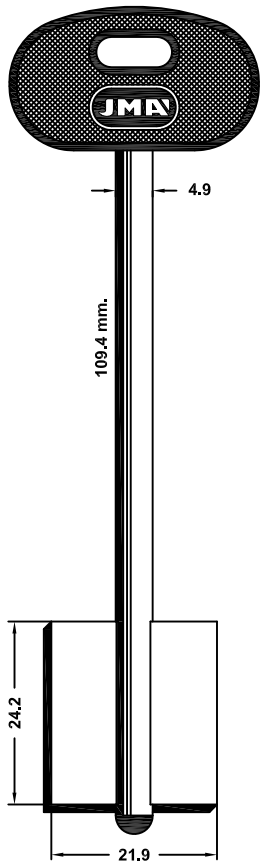

MOTTURA

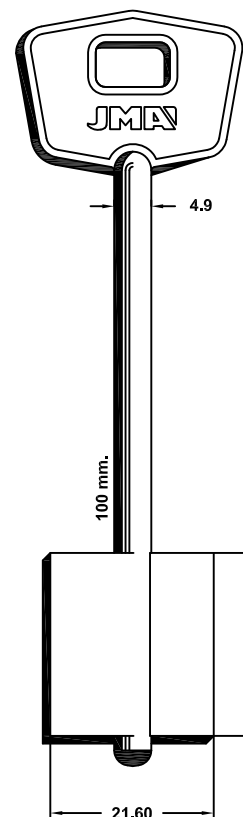
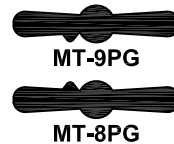
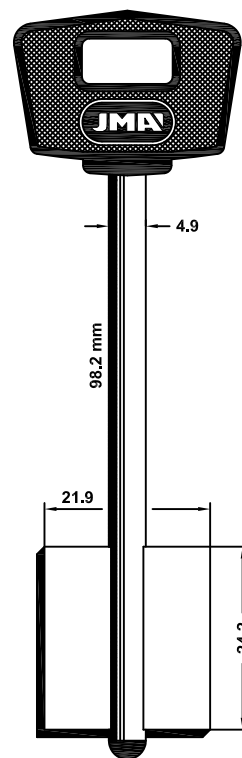
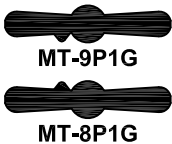
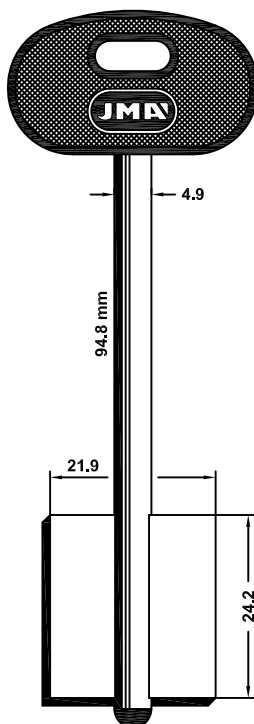
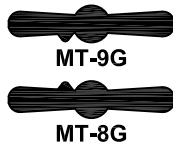
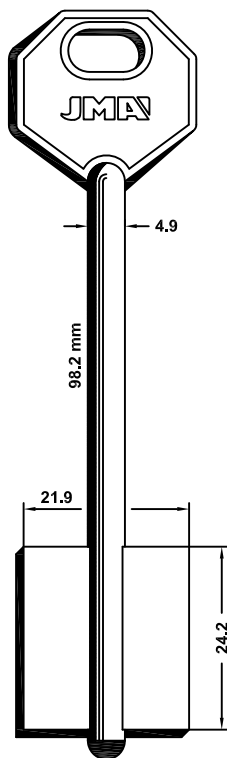

MOTTURA

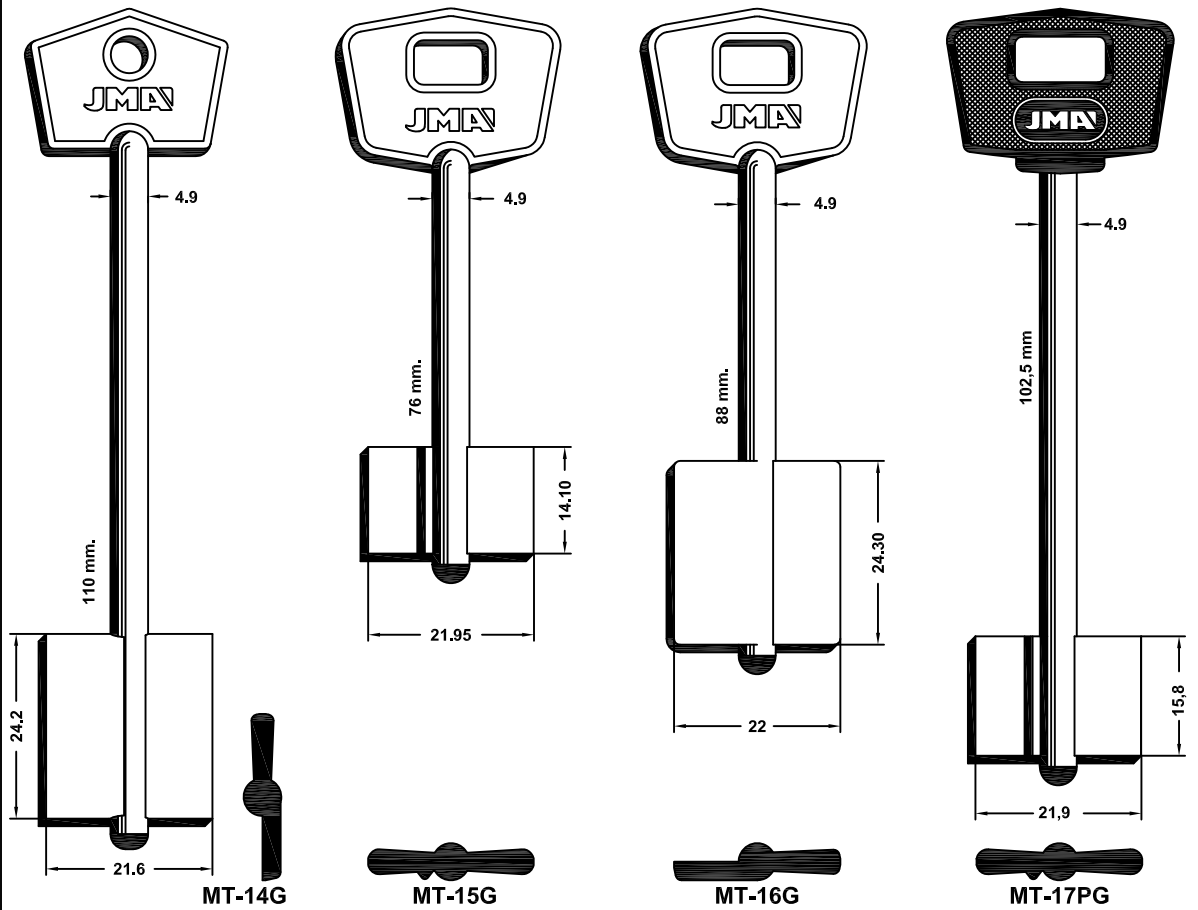

PARA-FOR:

- MOTTURA (I)
- OMEC (I)
- ORENGO (E)
- PATRONE (I)

MOTTURA	OMEC	ORENGO	PATRONE
<p>MT-18G</p>	<p>OMC-1G</p>	<p>OR-2G</p> <p>CF</p>	<p>PAT-1G</p>



PARA-FOR:

POTENT (I)

POTENT

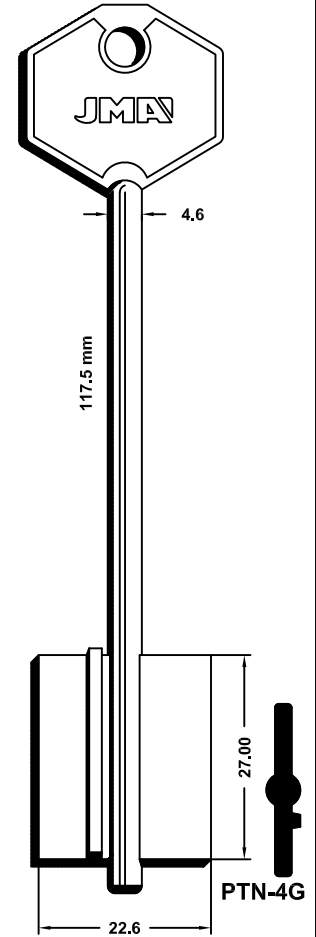
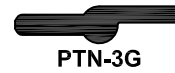
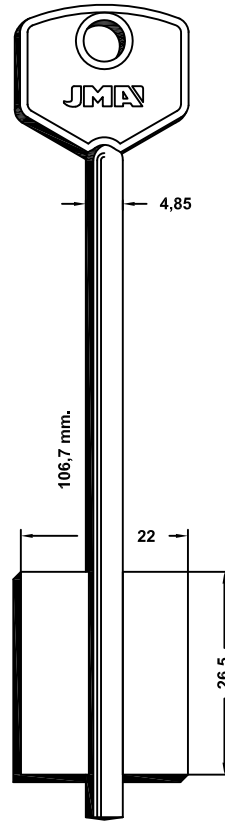
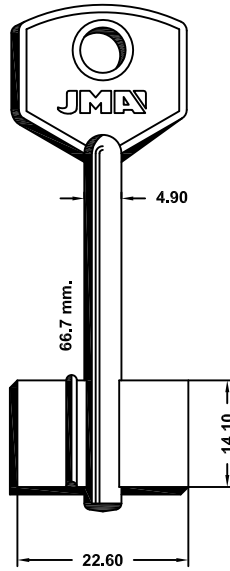
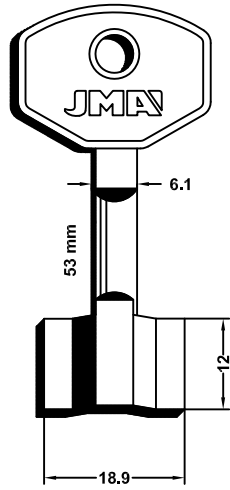

POTENT

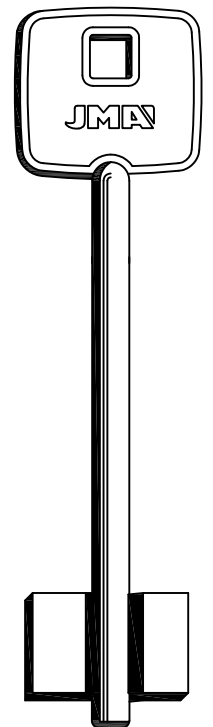
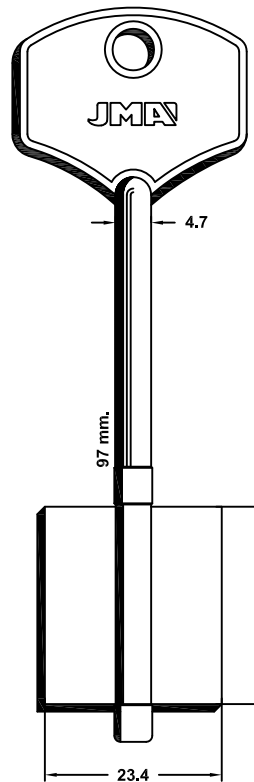
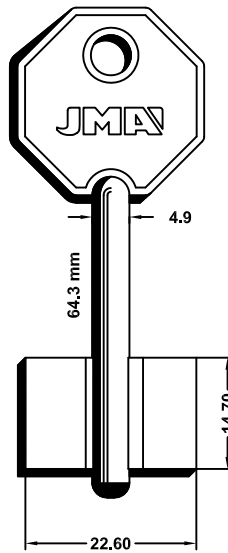
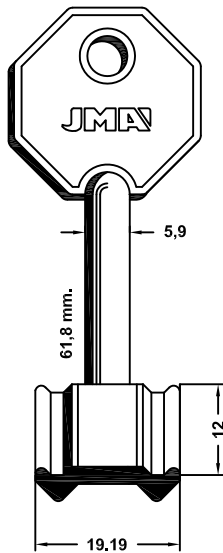

POTENT

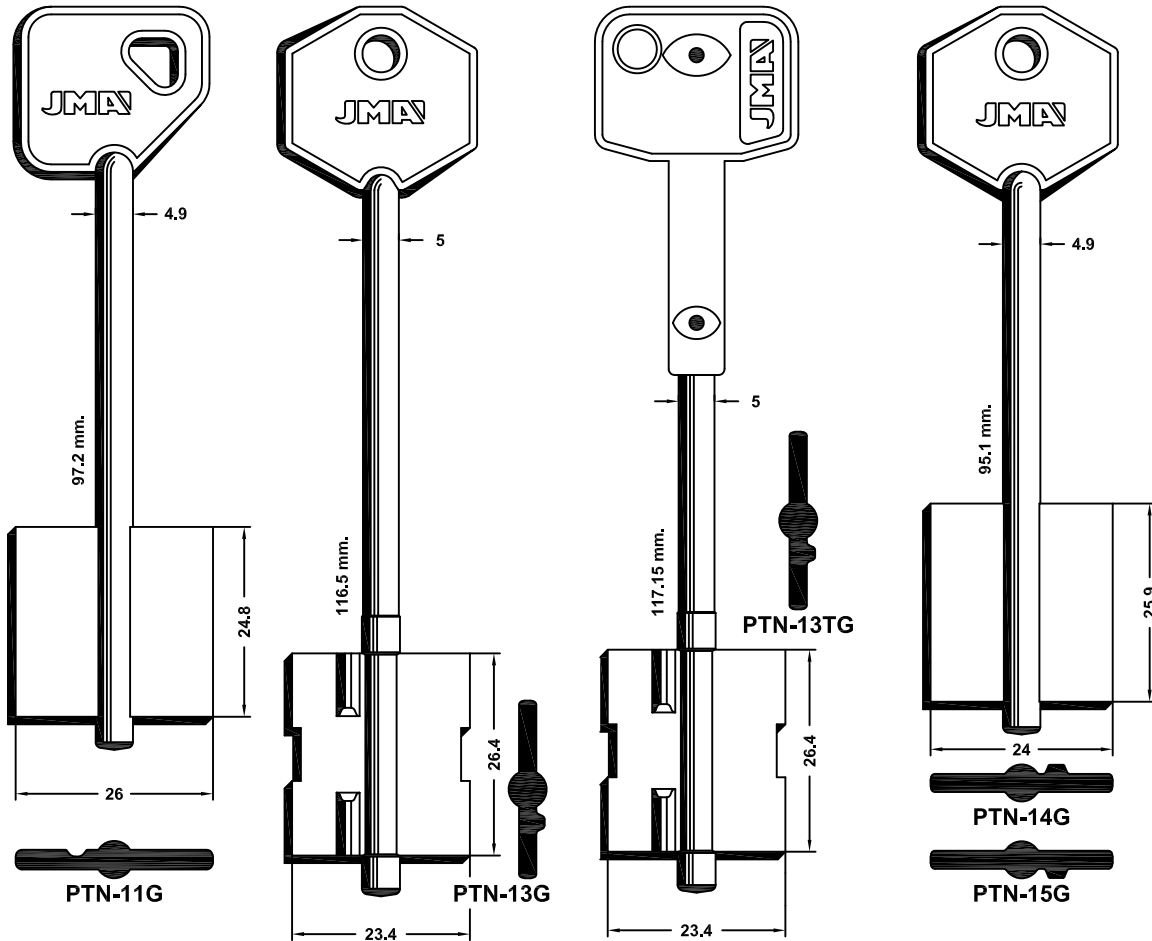

PARA-FOR:

- POTENT (I)
- PREFER (I)
- REVI (E)

PREFER

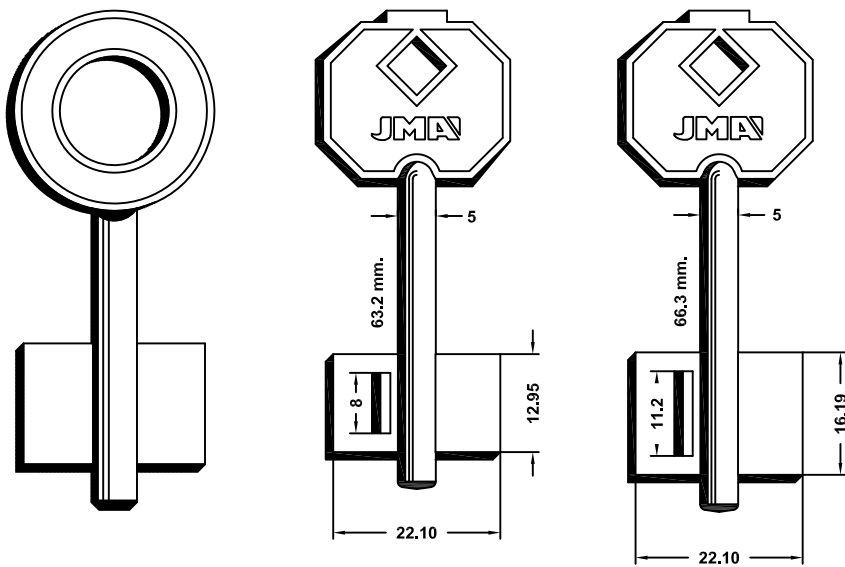

REVI

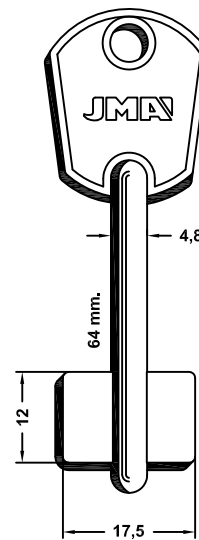

PR-1G



PR-3G



PR-4G



REVI-1G



PARA-FOR:

RIGAL (RUS)

RUBEN (RUS)

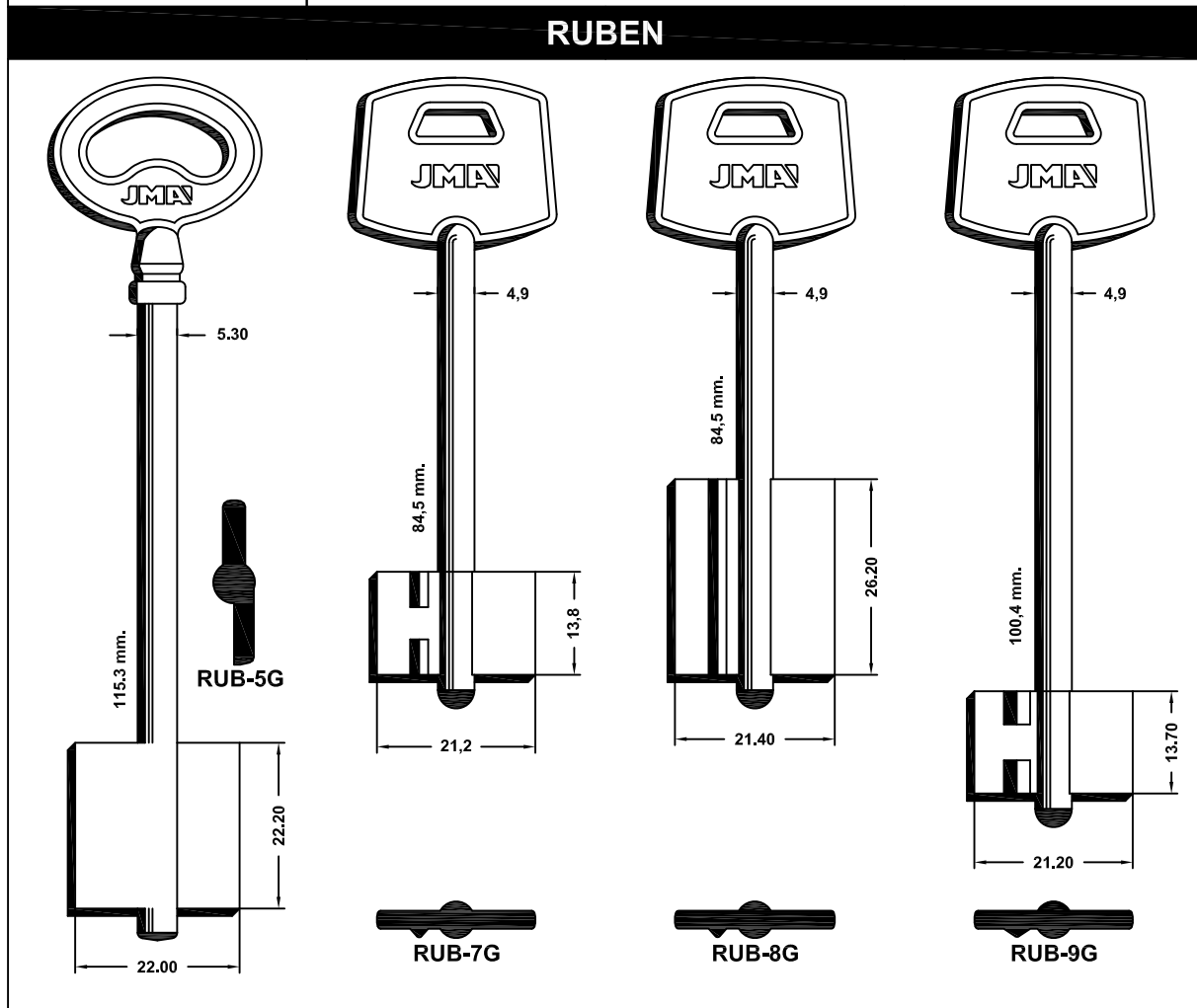
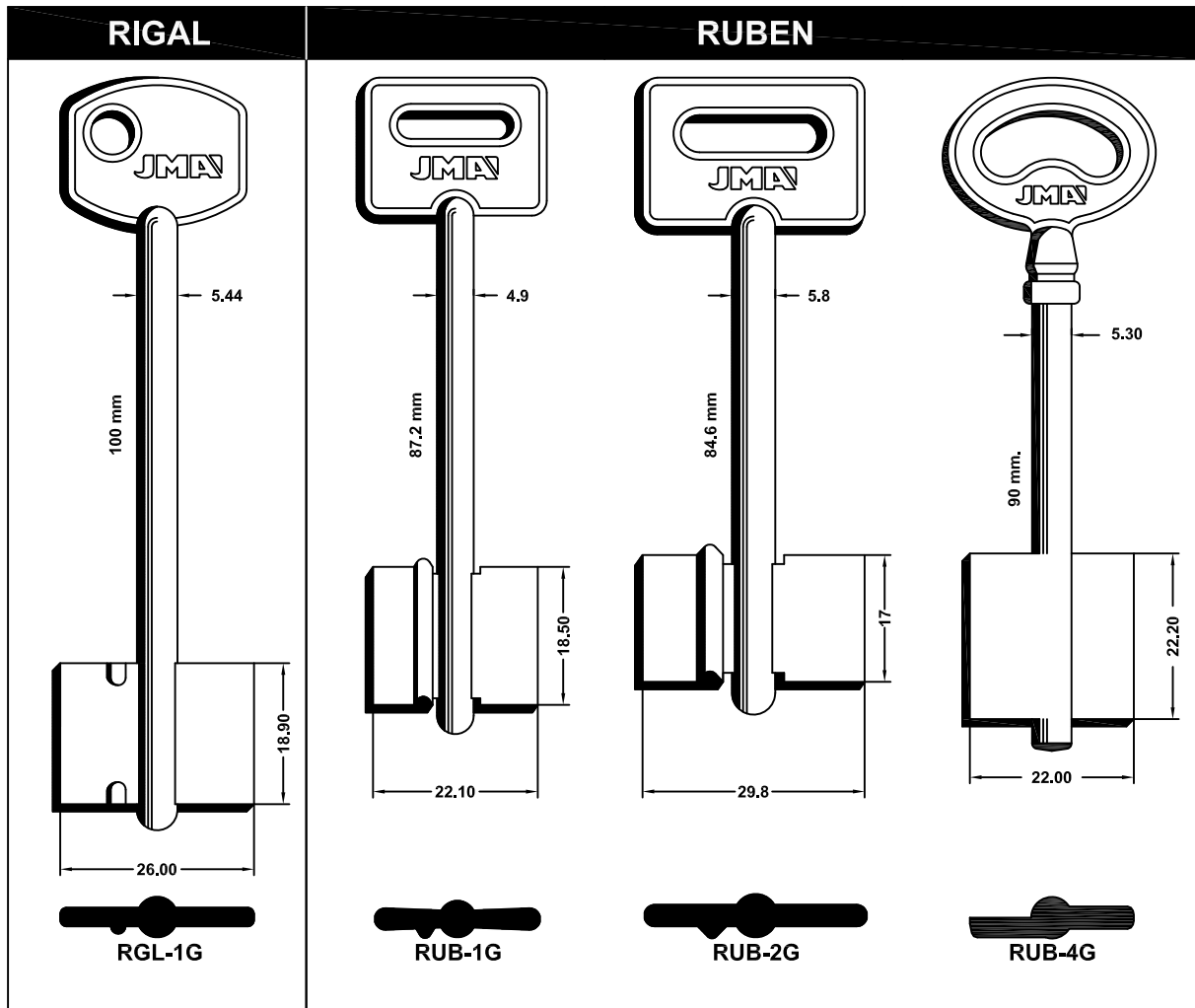

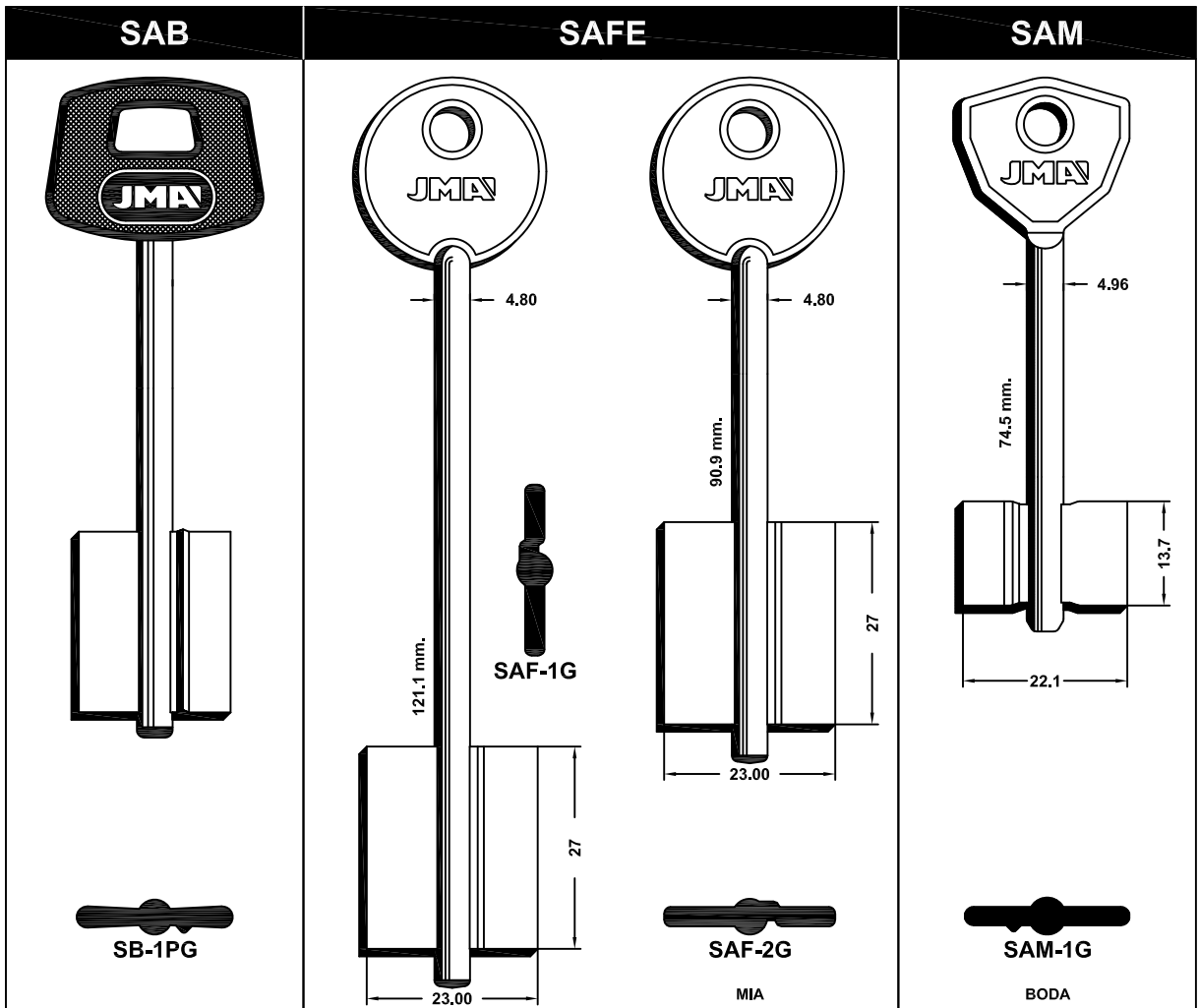

PARA-FOR:

- SAB (I)
- SAFE (I)
- SAM (RUS)
- SECUREMME (I)

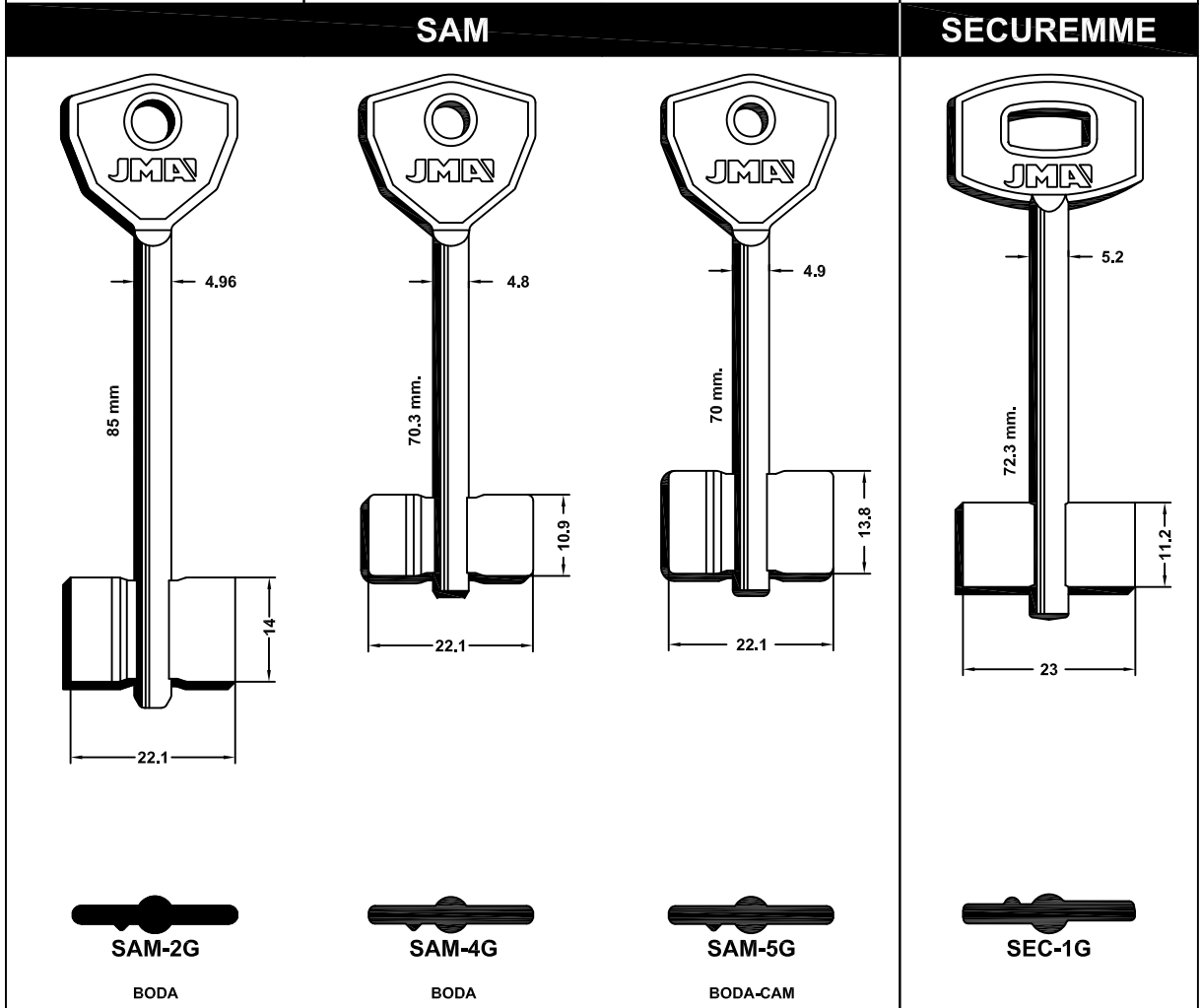

PARA-FOR:

SECUREMME

SECUREMME (I)

SERMEC (I)

SIAS (I)

SIBI (I)

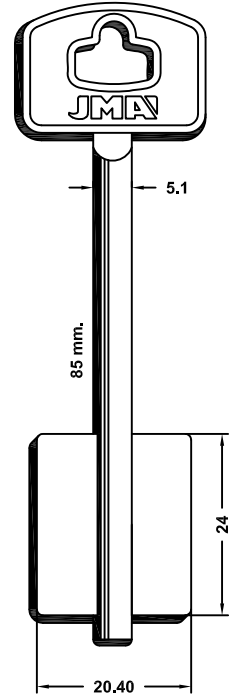
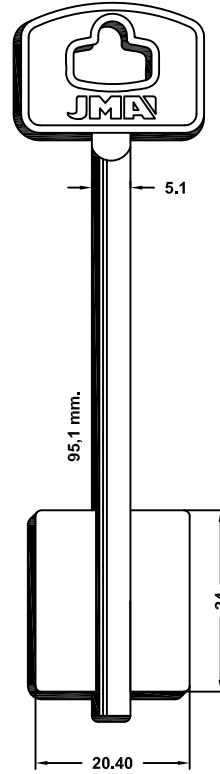
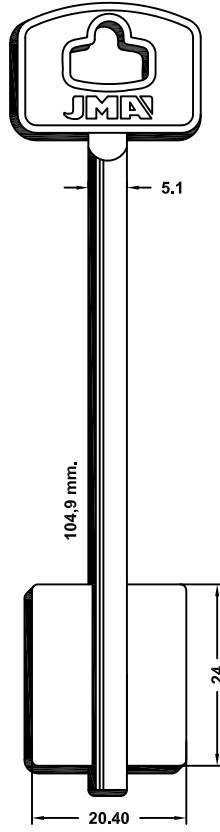
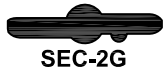
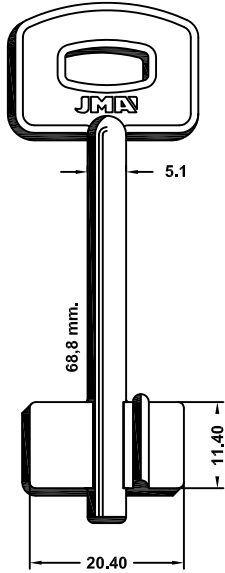

SERMEC

SIAS

SIBI

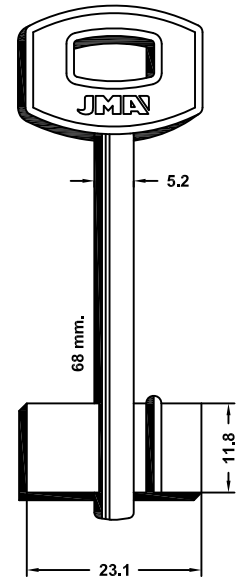
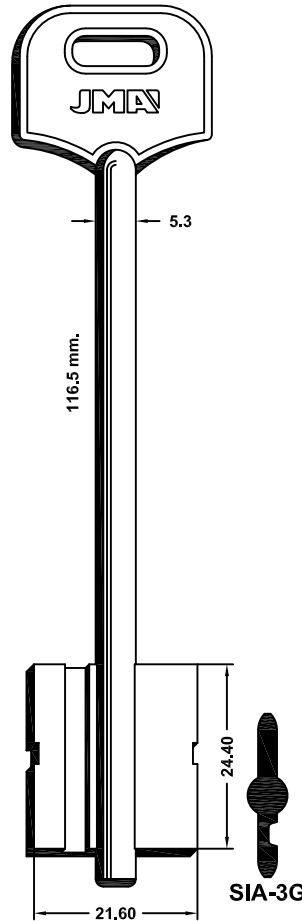
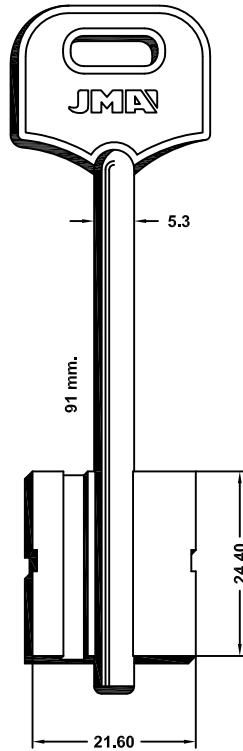
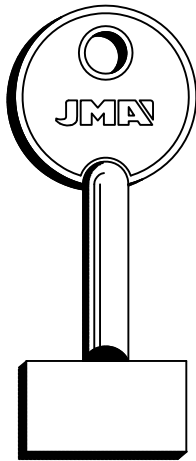

SIBI

SIDERAL

PARA-FOR:

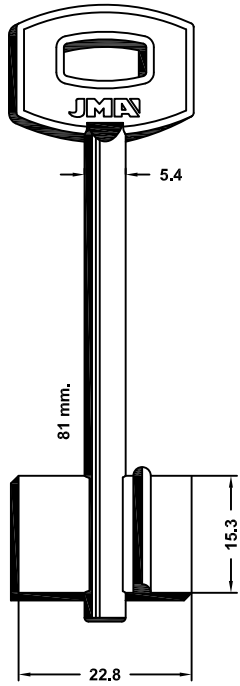

SIB-3G

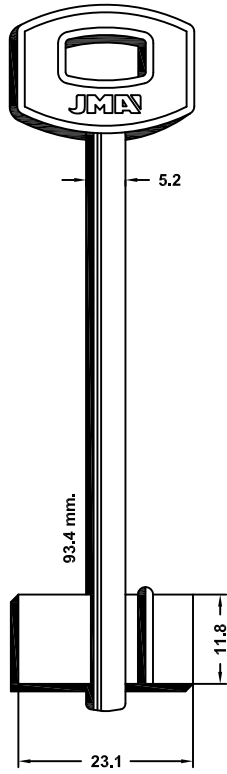

SIB-4G

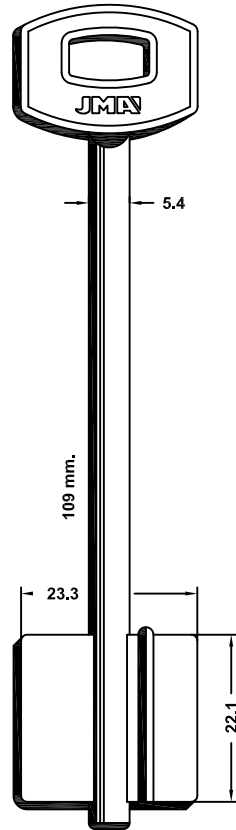

SIB-5G

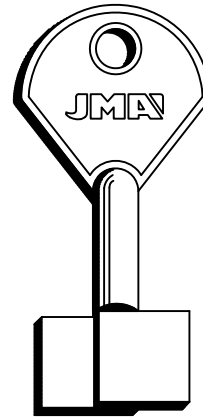

SDR-1G

SIBI (I)

SIDERAL (I)

TECSESA (E)

TESIO (I)

SIDERAL

TECSESA

TESIO

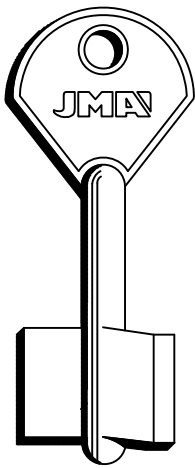

SDR-2G

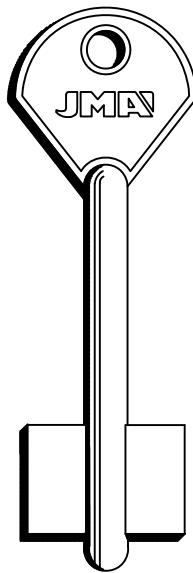

SDR-3G

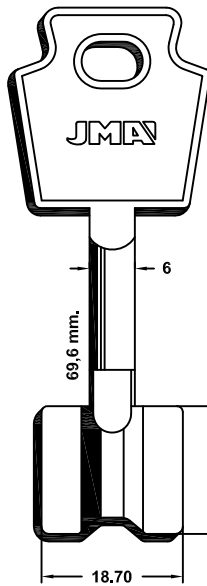

TEC-1G

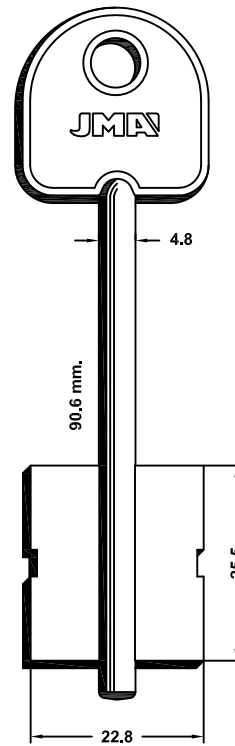

TSI-1G



PARA-FOR:





TITANIO (I)



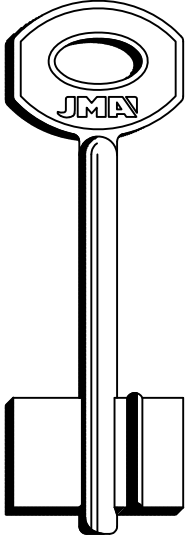
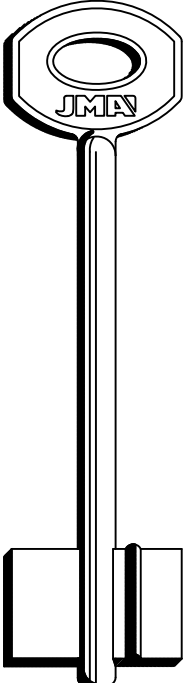
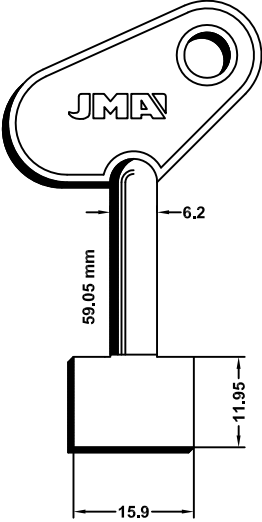
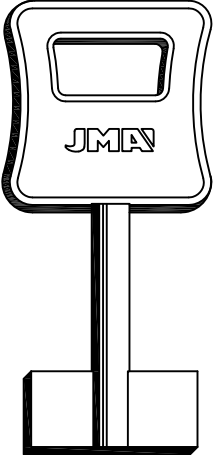

TOVER (E)

4 TR (I)

TUSHINO (RUS)

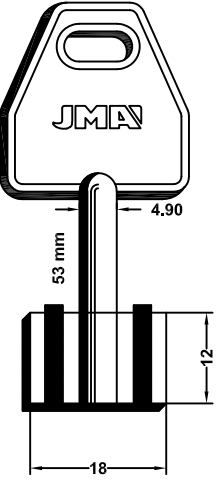
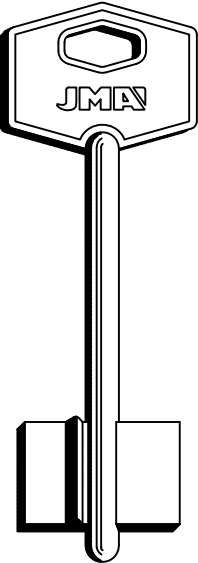
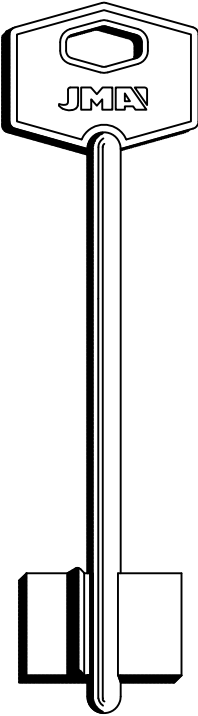
WELKA (I)

TITANO		TOVER	4 TR
			
			
TTN-1G	TTN-2G	TOV-1G	TR-1G

TUSHINO	WELKA	
		
		
TUS-1G	WE-1G	WE-2G



YALE

PARA-FOR:

YALE (I)

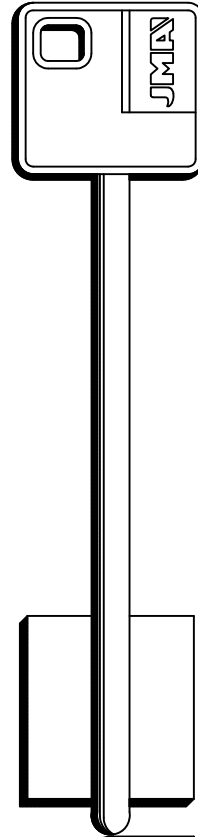
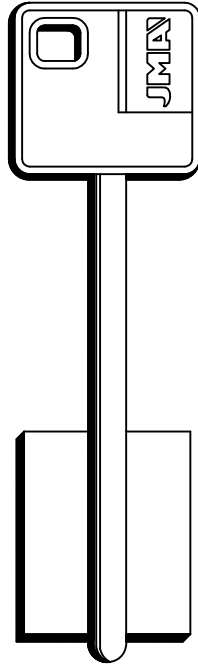
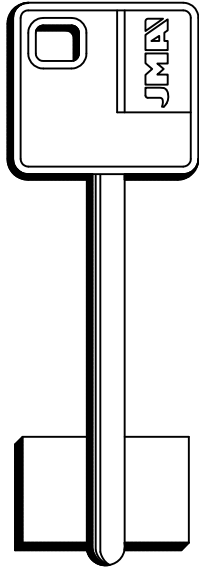
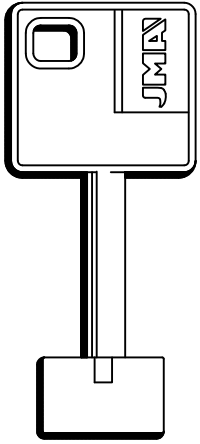

YA-1G



YA-2G



YA-3G



YA-4G



PARA-FOR:

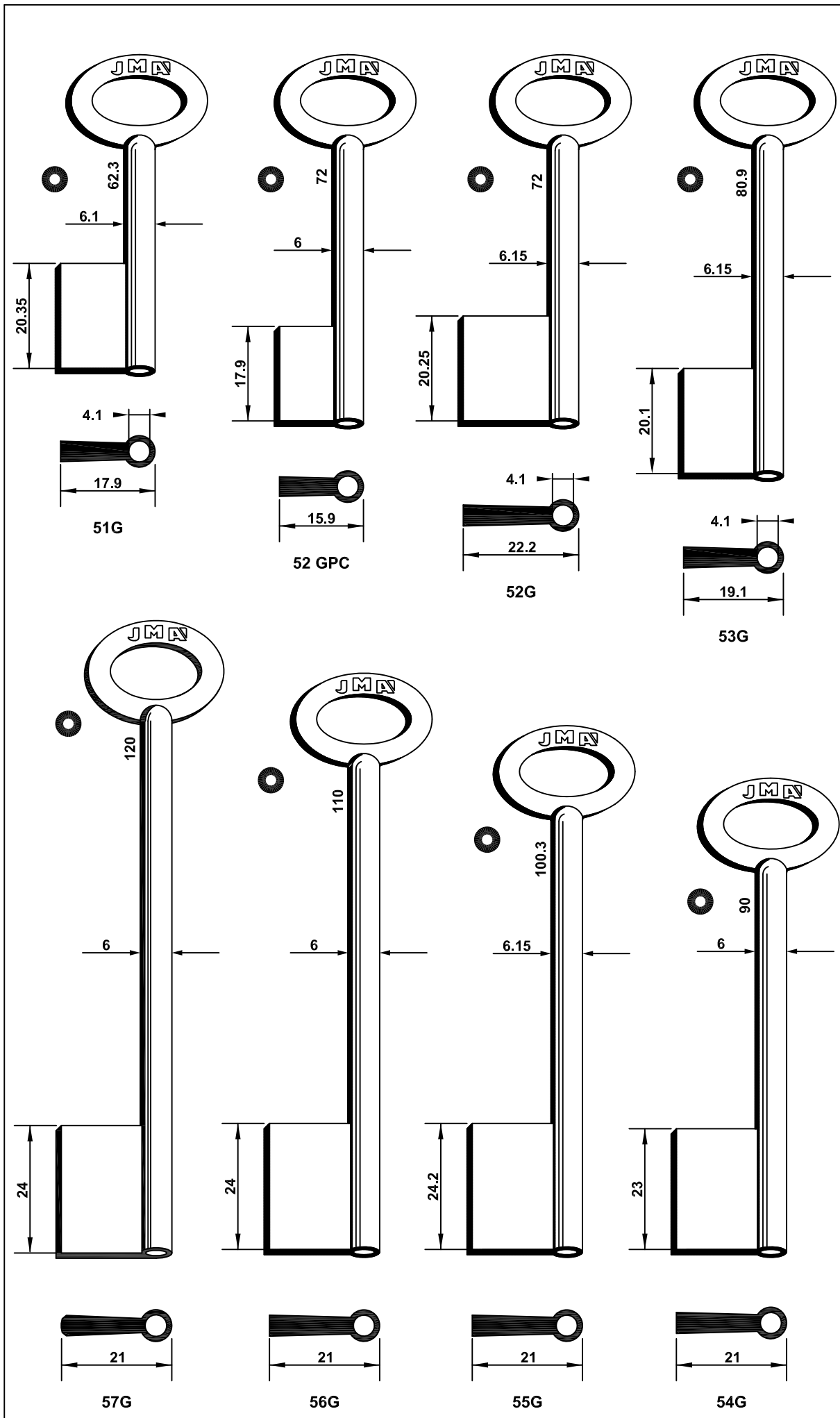

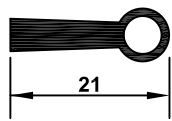
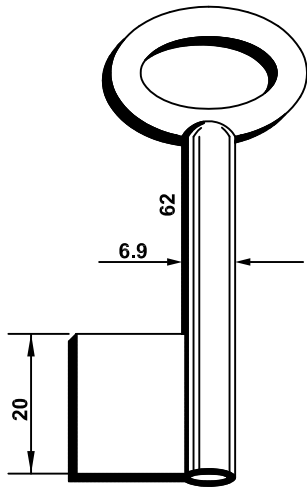

66G

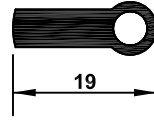
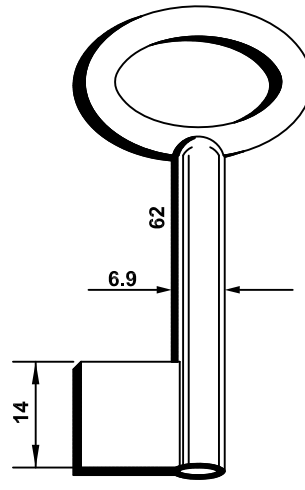

68G

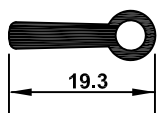
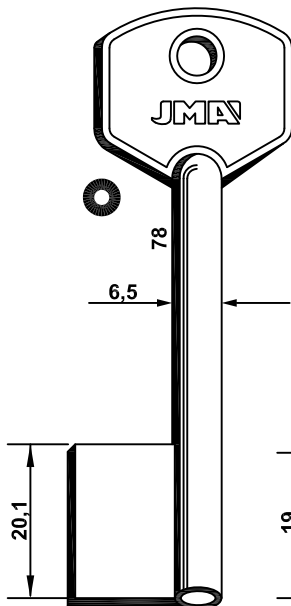

72G

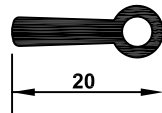
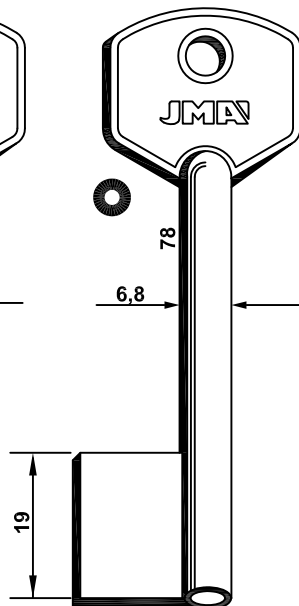

73G



PARA-FOR:

- ABUS (D)
- AGA (E)
- ALEDAL (S)
- ARCU (E)

		ABUS	AGA
AGA	ALEDAL	ARCU	



ARCU

PARA-FOR:

ARCU (E)

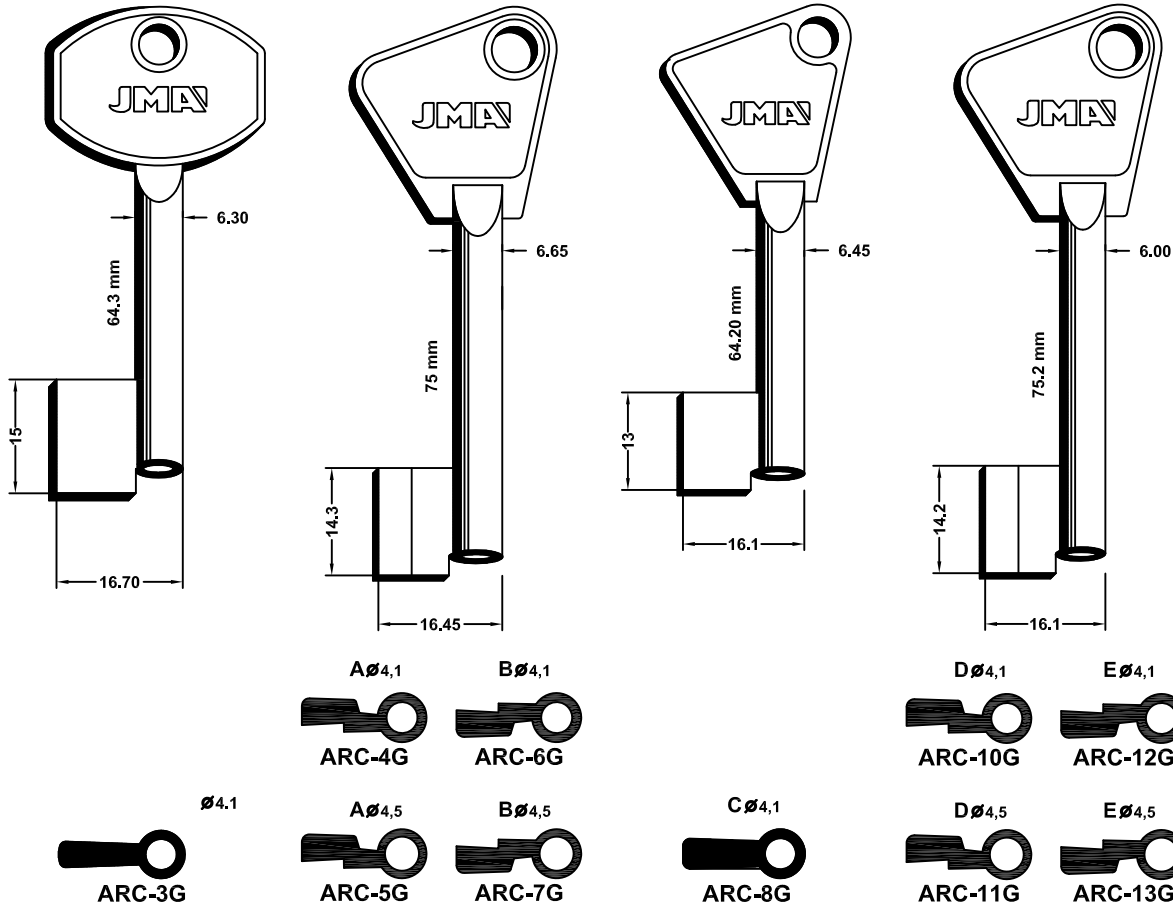

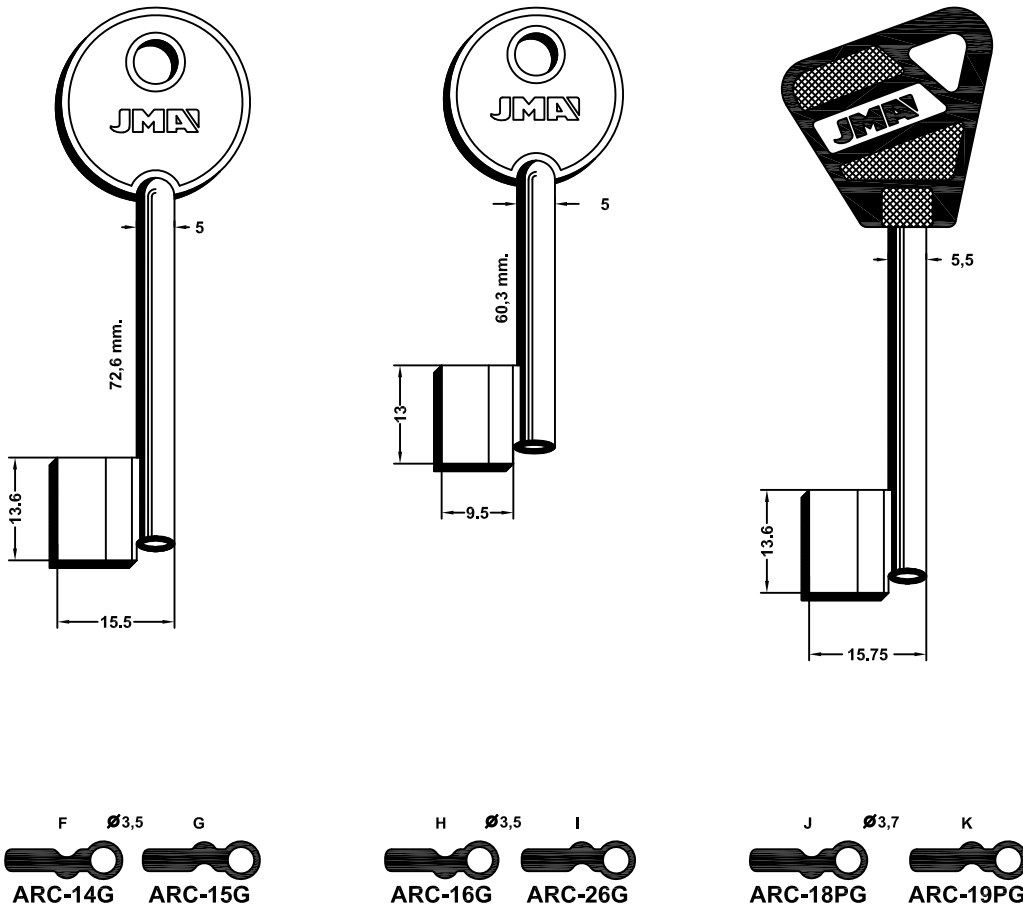

ARCU

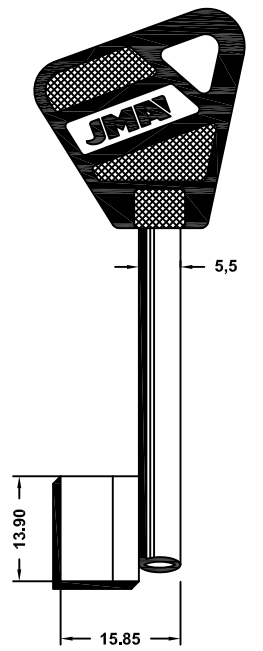
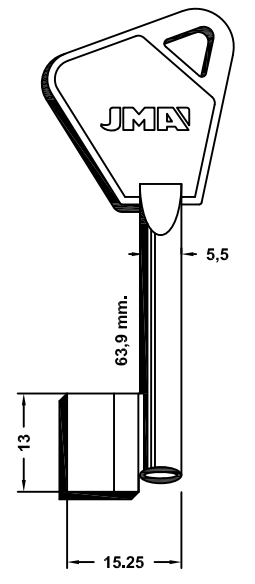
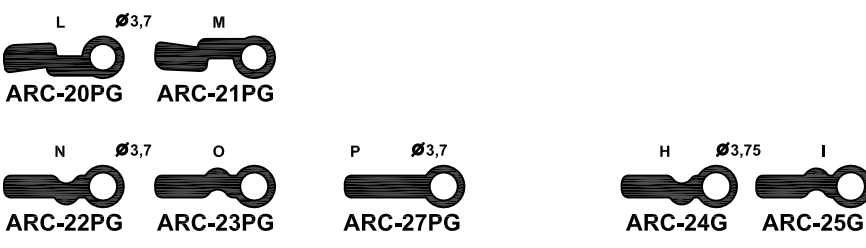
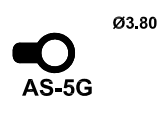
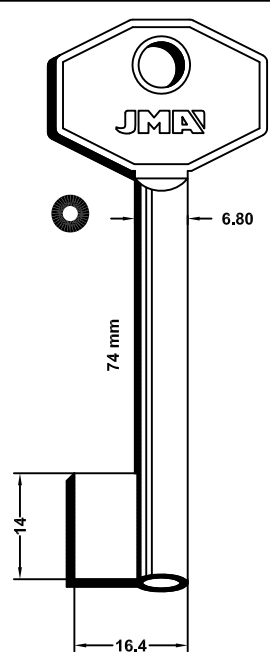
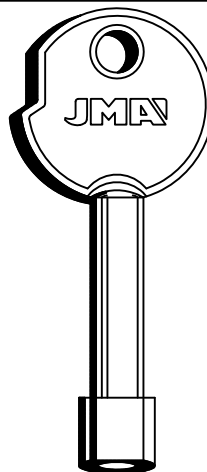
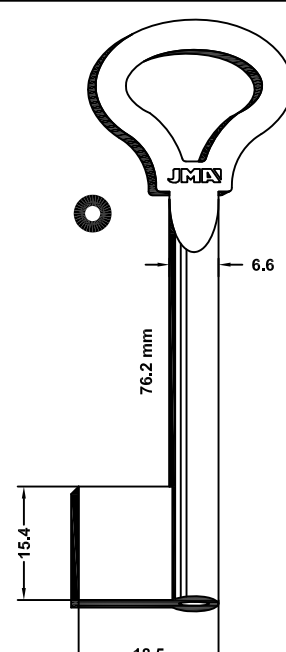
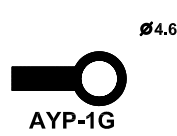

PARA-FOR:

- ARCU (E)
- ASSA (S)
- AYPE (E)
- CERUTTI (I)
- LAR (E)

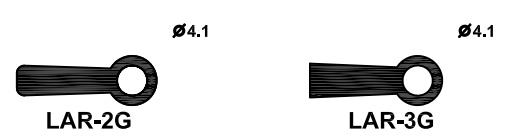
ARCU		ASSA			
					
					
AYPE		CERUTTI		LAR	
					
					



ORENGO

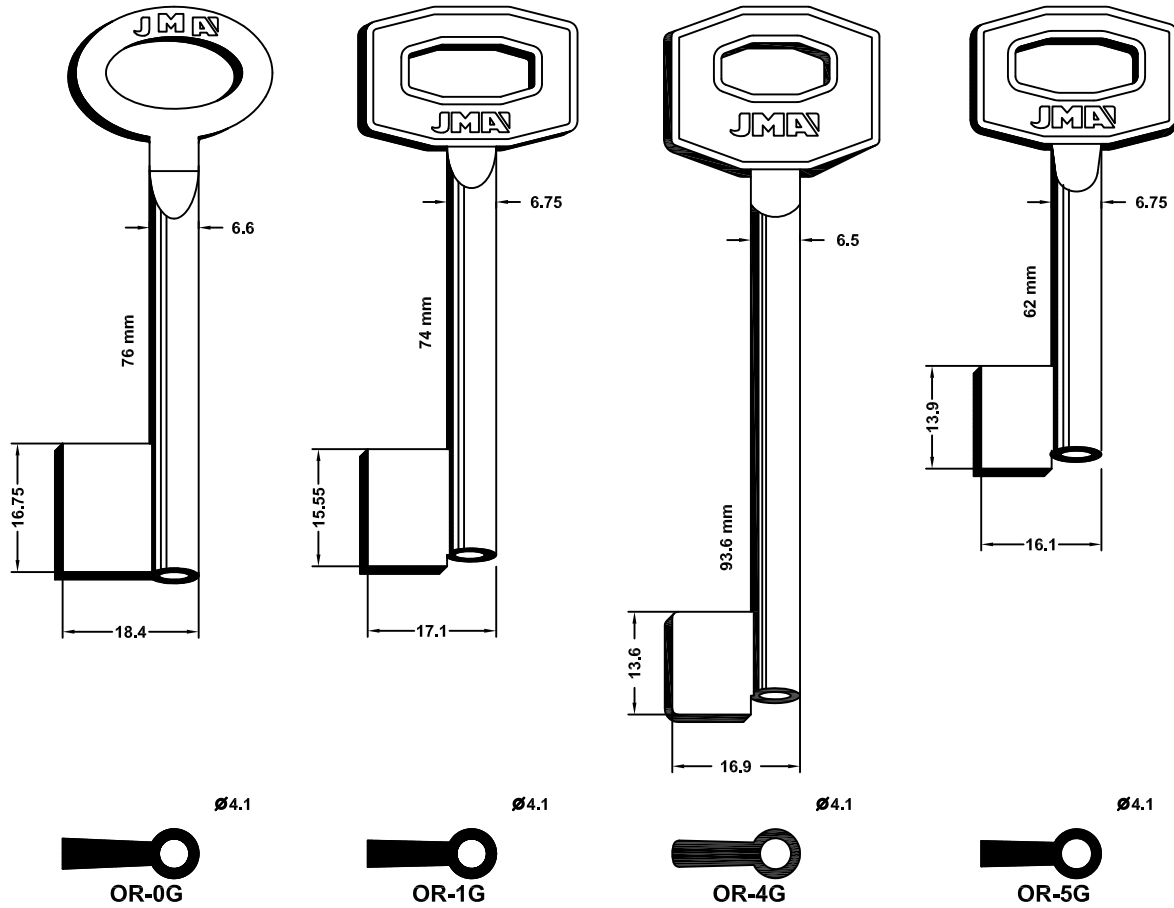

PARA-FOR:

- ORENGO (E)
- RUBEN (RUS)
- RUE (F)
- VILLFER (E)

RUBEN

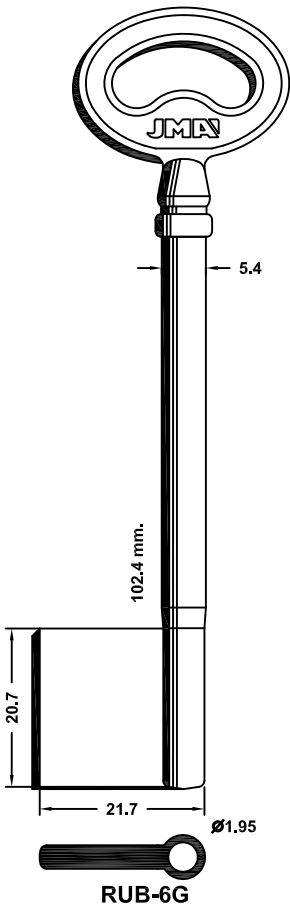

RUE

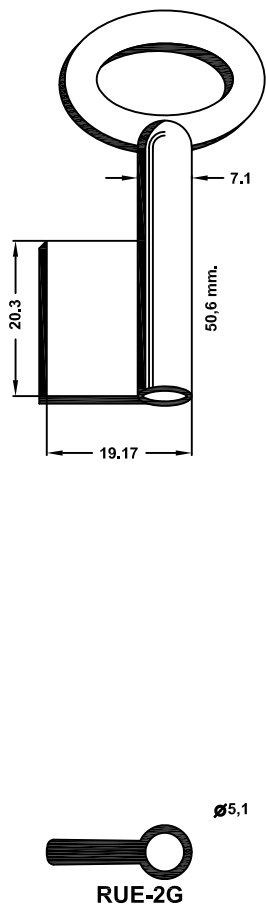

VILLFER

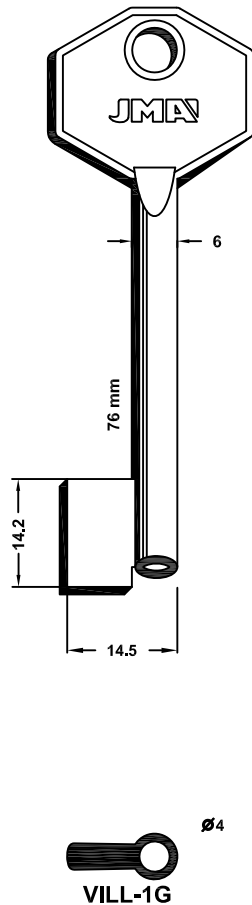

PARA-FOR:

AGA (E)

ARES (RUS)

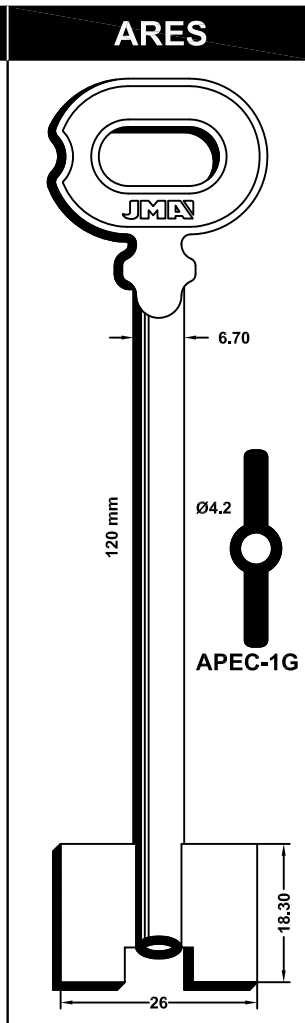
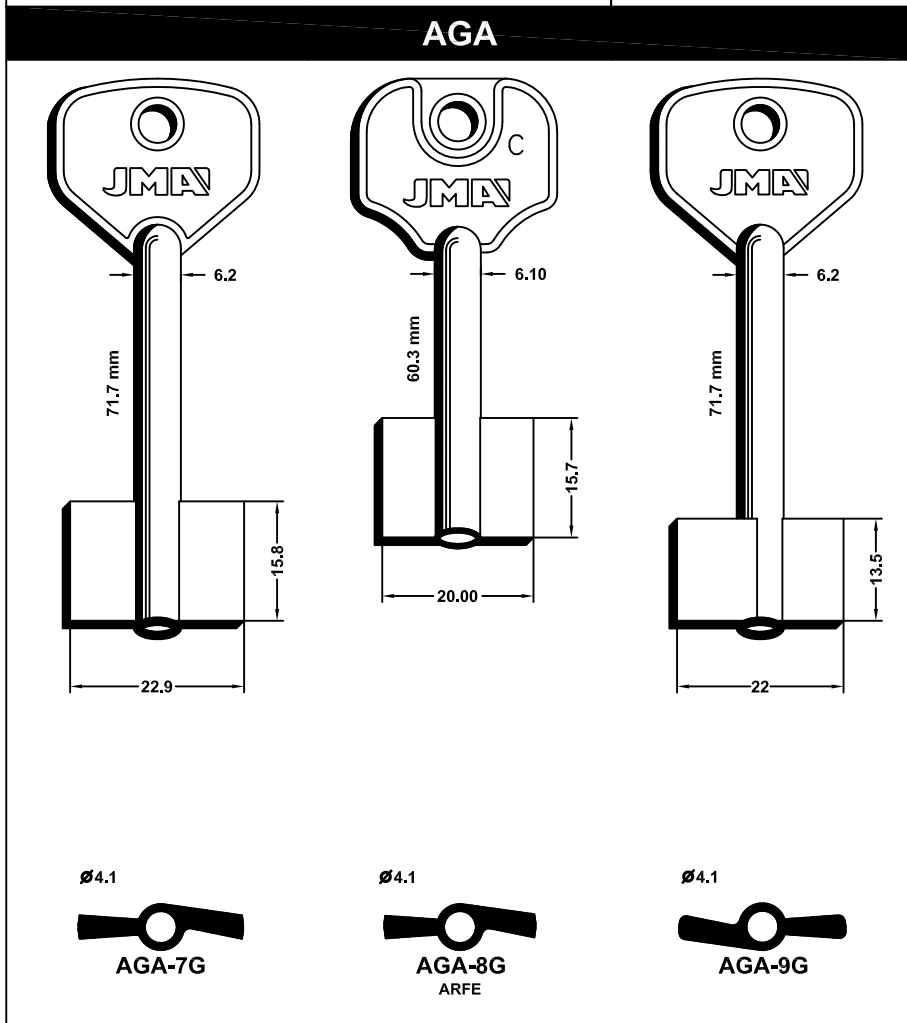
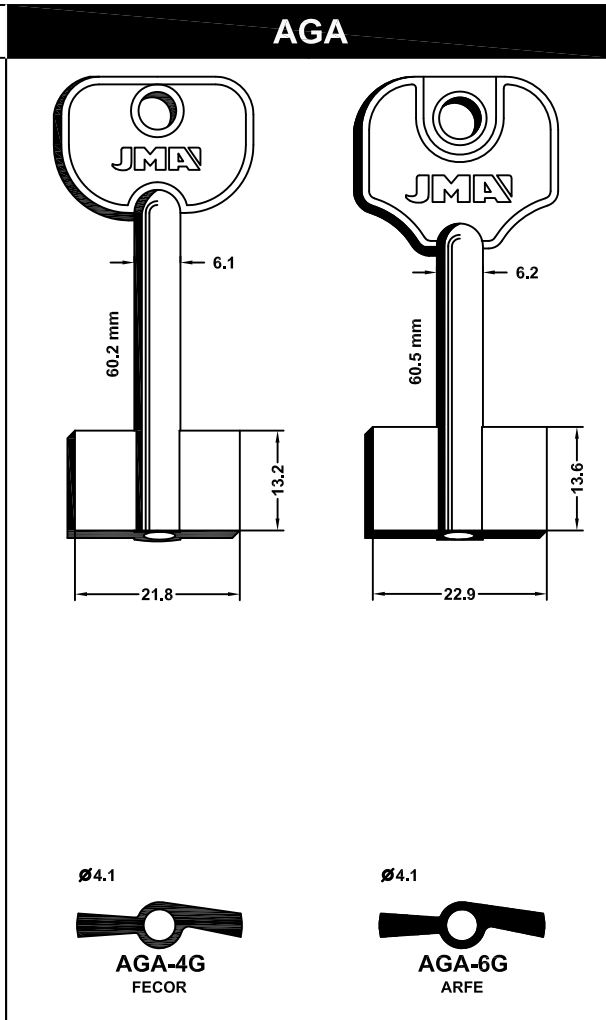
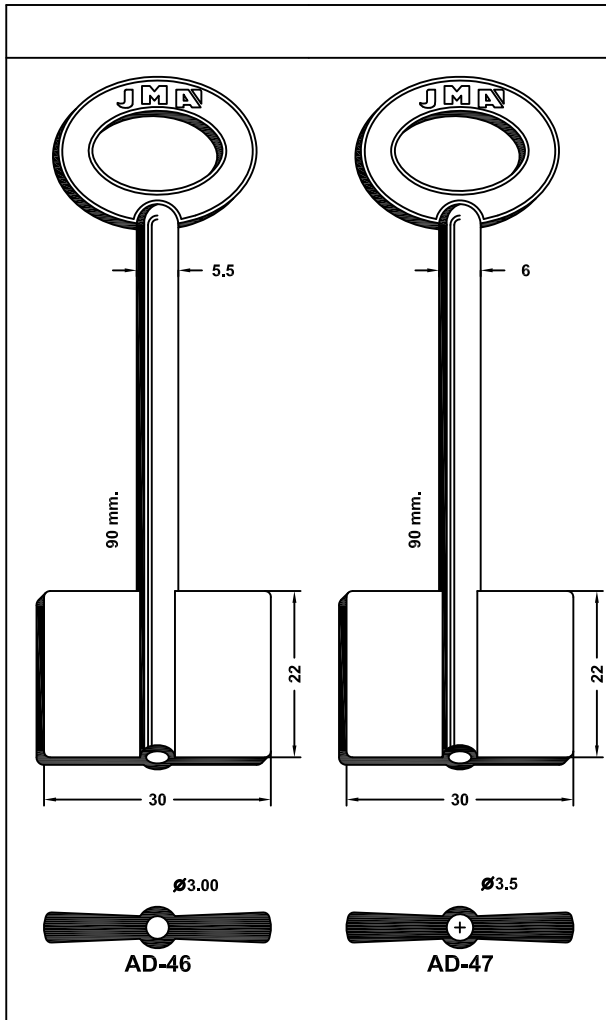

ARES	BURG	CRONOS	DUPLEX
<p>78 mm 6.70 18.30 26 Ø4.20 APEC-2G</p>	<p>68 mm. 6.4 16.5 23 Ø4 BUR-1G</p>	<p>68 mm. 6 12 24 Ø4 CRO-1G</p>	<p>75 mm. 6.00 16.00 28.90 Ø3,5 DUP-1G</p>

PARA-FOR:
 ARES (RUS)
 BURG (D)
 CRONOS
 DUPLEX (RUS)
 DVERNIAK (RUS)

DVERNIAK

<p>120 mm 6.70 18.30 26 Ø4.2 DV-2G</p>	<p>100 mm 6.50 20 32 Ø3.80 Ø3.80 DV-4G</p>	<p>71,2 mm 5.44 17.70 24,60 Ø3.7 DV-10G/A</p>	<p>99,7 mm 6.00 17.70 27.40 Ø3.60 Ø3.60 DV-11G</p>
--	--	---	--



PARA-FOR:

DVERNIAK (RUS)

EREVAN (RUS)

MACOR (E)

MAXIM (RUS)

PREFER (I)

RUBEN (RUS)

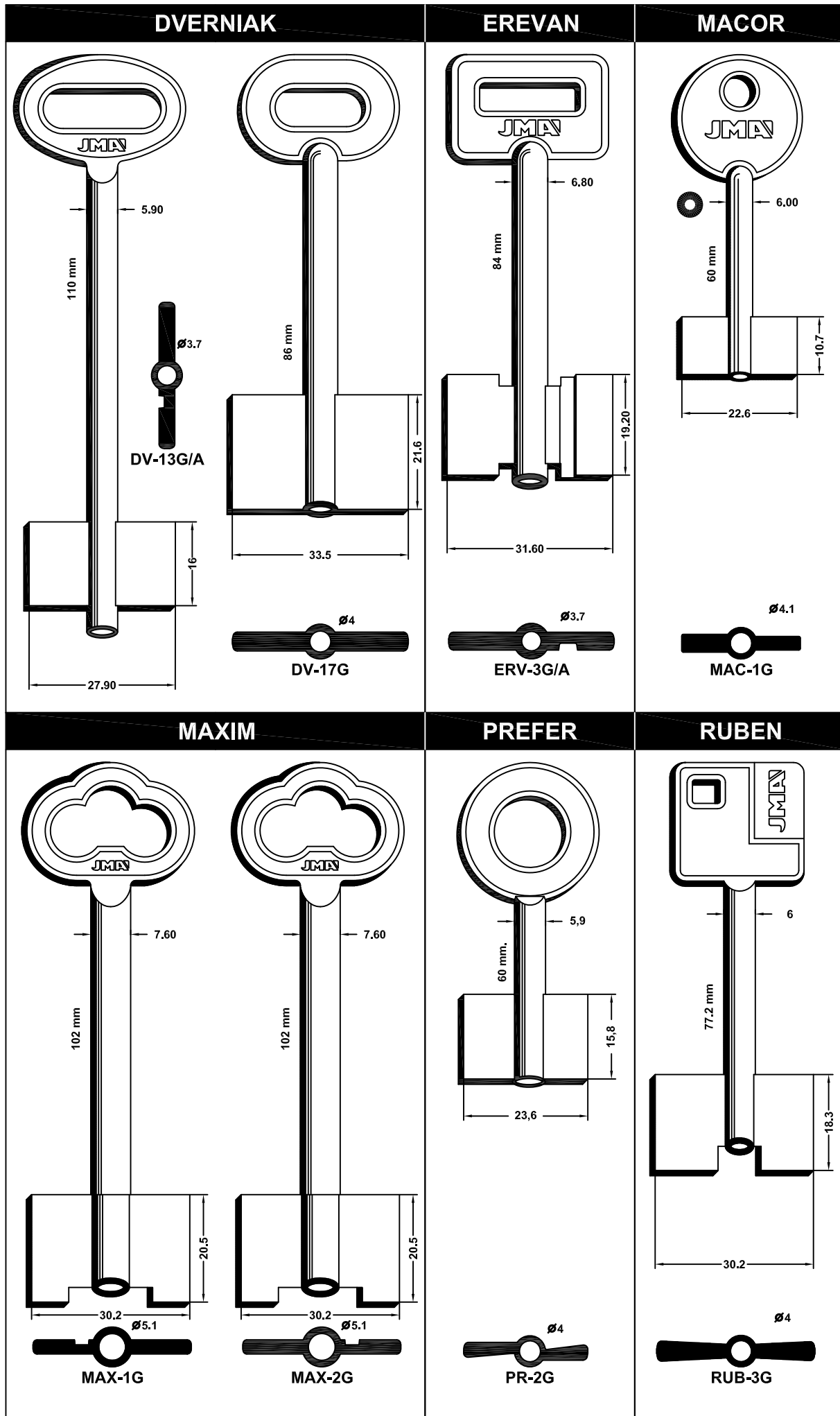

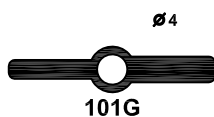
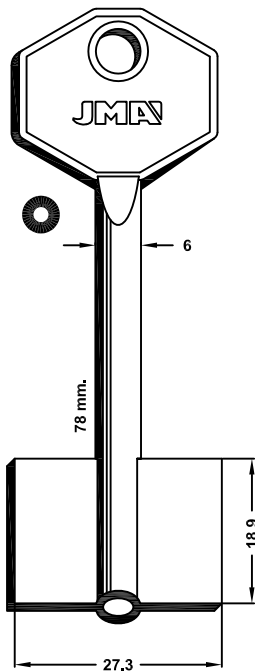
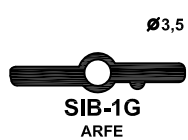
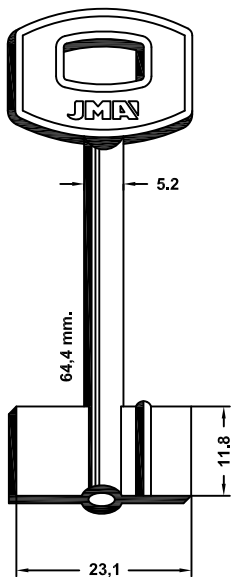
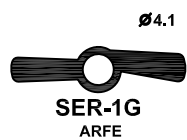
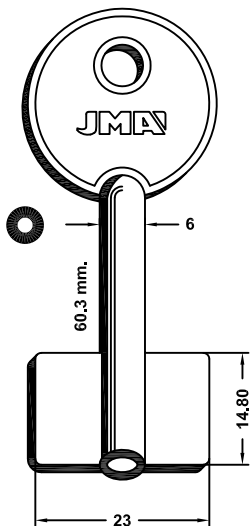
SERRALLER**SIBI**

PARA-FOR:
SERRALLER (E)
SIBI (I)



LLAVES DE GORJA ZAMAK

ZAMAKEZKO GORJA GILTZAK

ZAMAK BIT KEYS

CLES A GORGES EN ZAMAK

CHUBBSCHLÜSSEL AUS ZAMAK



THE KEY TO EXCELLENCE
GLOBALLY UNLOCKING MILLIONS OF DOORS DAILY

AGA

PARA-FOR:

AGA (E)

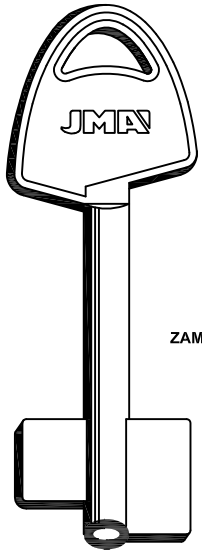

ZAM.

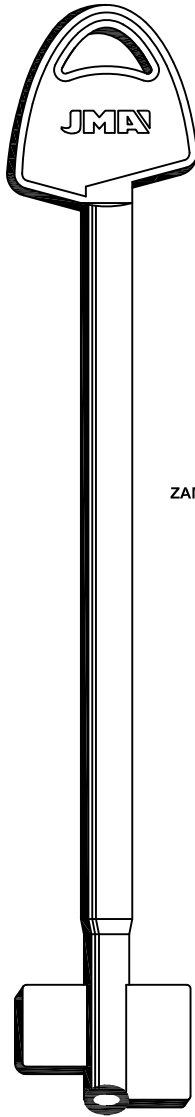

ZAM.

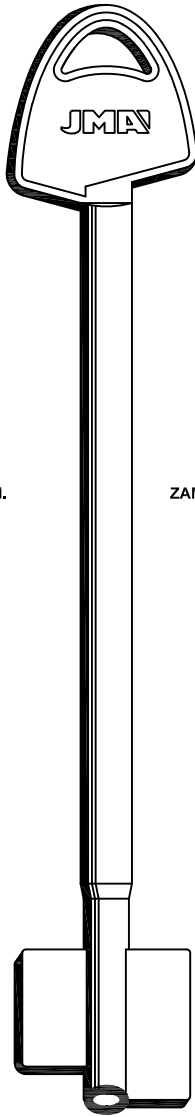

ZAM.

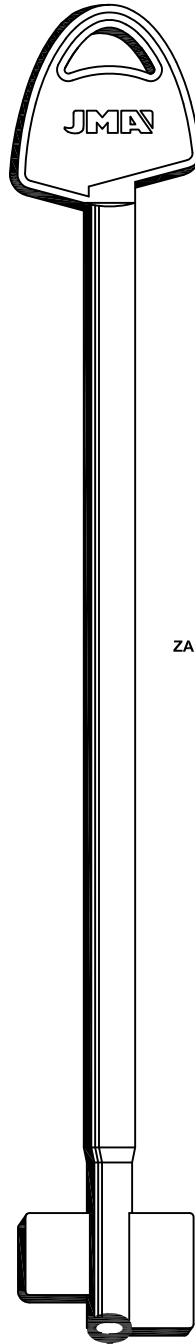

ZAM.

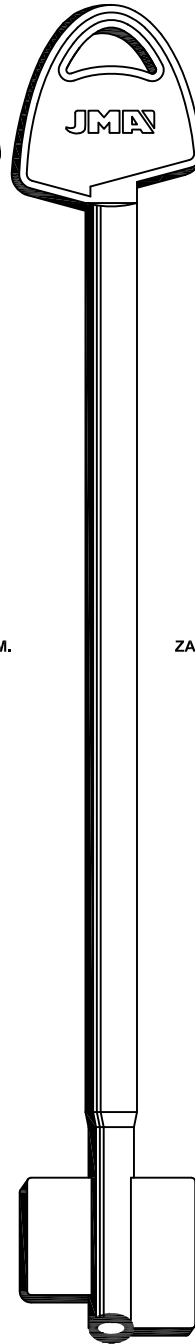

ZAM.



AGA-15G



AGA-23G



AGA-27G



AGA-35G



AGA-40G



PARA-FOR:

AGA (E)

CAS CISMA (I)

NEMEF (D)

AGA

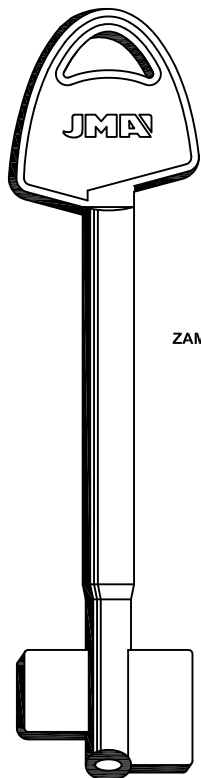

ZAM.



AGA-46G

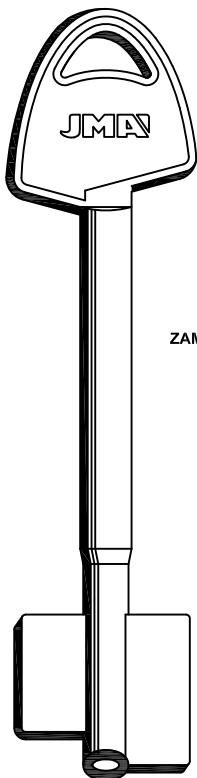

ZAM.



AGA-50G

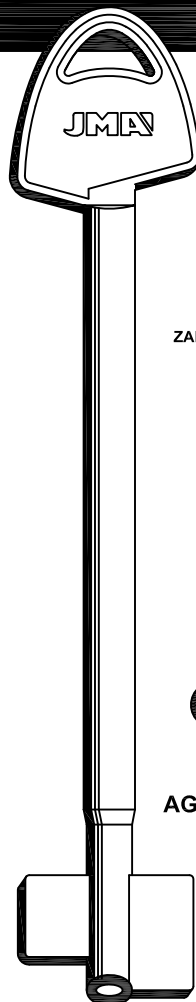

ZAM.

AGA-48G

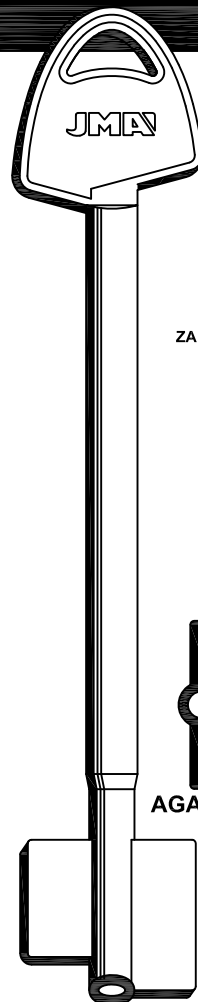

ZAM.

AGA-49G

CAS CISMA

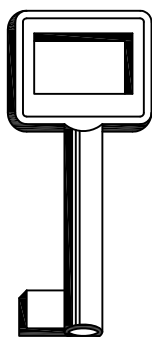

ZAM.



CIS-803/....

NEMEF

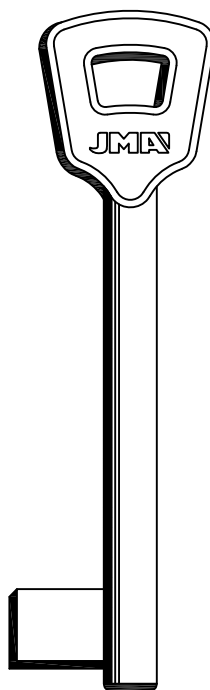

NEF-2Z-..



ZAM.

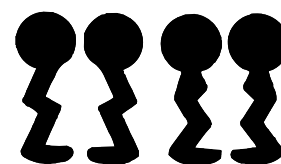
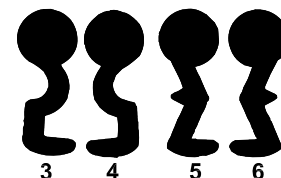

BMH-FH-VACHETTE



LLAVES ARTÍSTICAS Y DE ARMARIO LATÓN

LETOIZKO GILTZAK: ARMAIRUETARAKO ETA ARTISTIKOAK

BRASS FURNITURE KEYS

CLES POUR MEUBLES EN LAITON

MOBELSCHLÜSSEL AUS MESSING



Tél. 04 73 84 84 94

info@palserviceminute.com



THE KEY TO EXCELLENCE

GLOBALLY UNLOCKING MILLIONS OF DOORS DAILY

PARA-FOR:

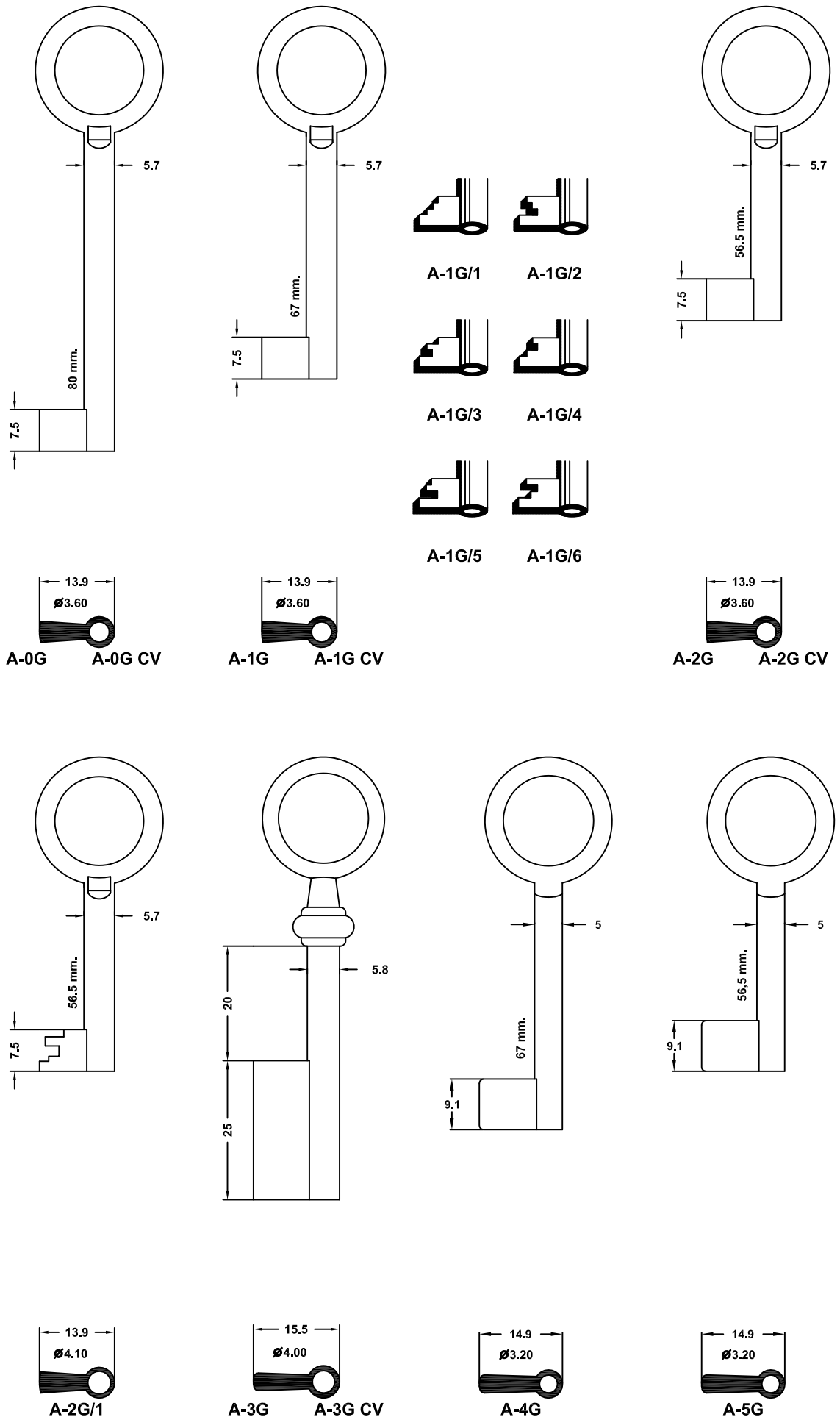

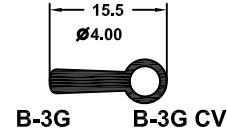
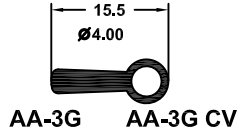
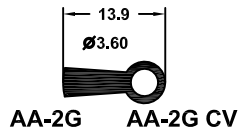
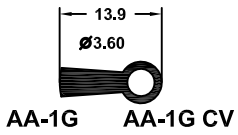
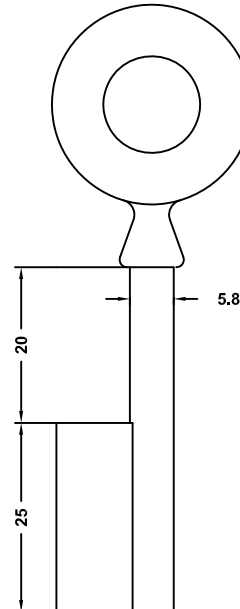
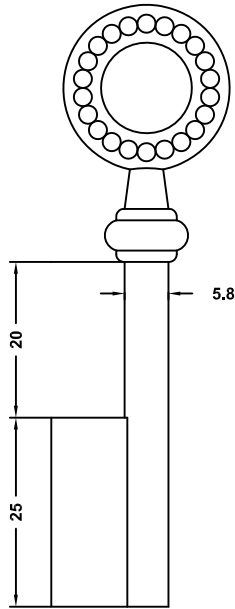
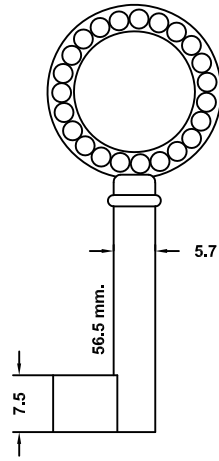
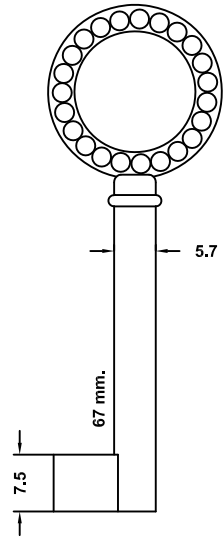

AA-1G AA-1G CV

AA-2G AA-2G CV

AA-3G AA-3G CV

B-3G B-3G CV

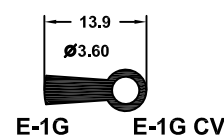
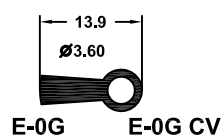
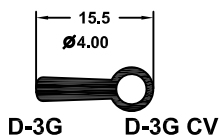
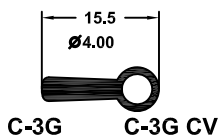
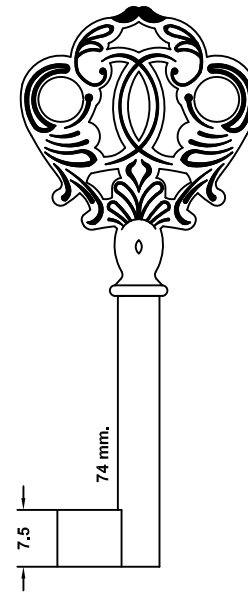
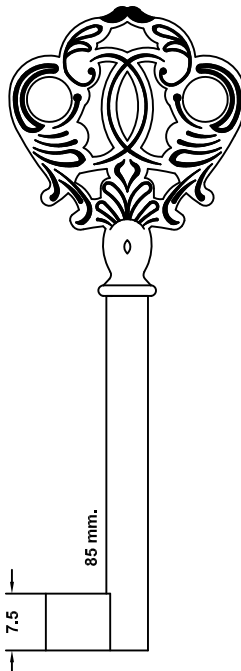
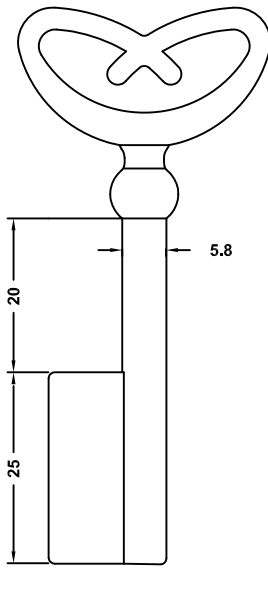
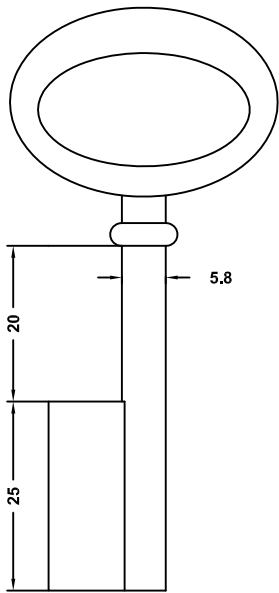

C-3G C-3G CV

D-3G D-3G CV

E-0G E-0G CV

E-1G E-1G CV



PARA-FOR:

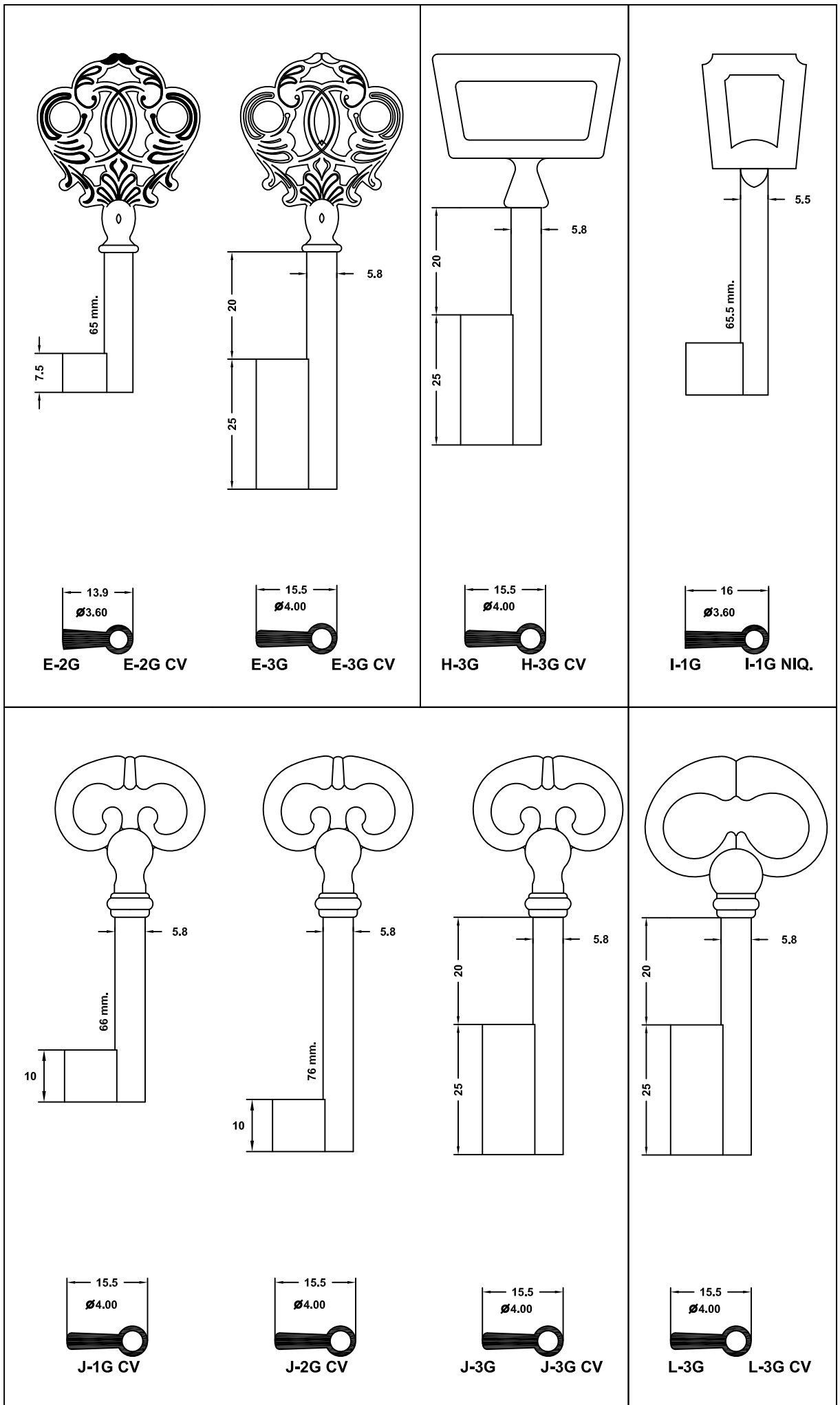

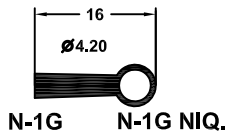
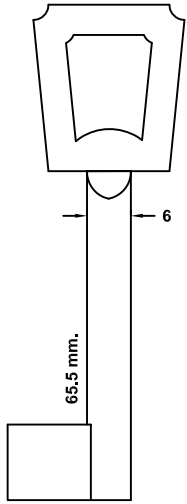

N-1G N-1G NIQ.

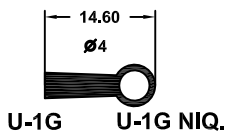
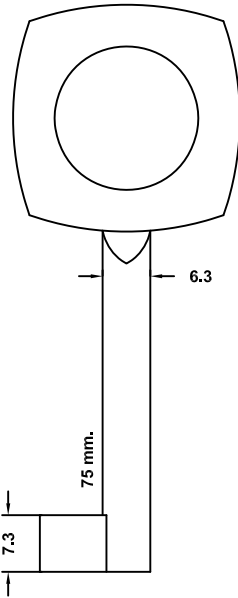

U-1G U-1G NIQ.

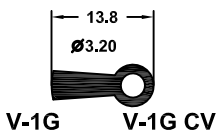
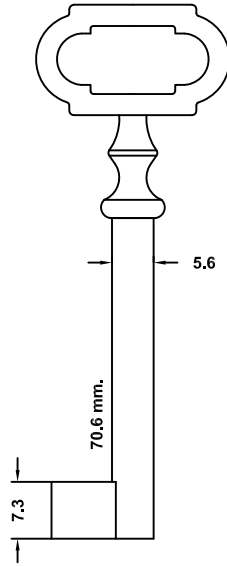

V-1G V-1G CV

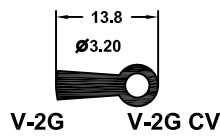
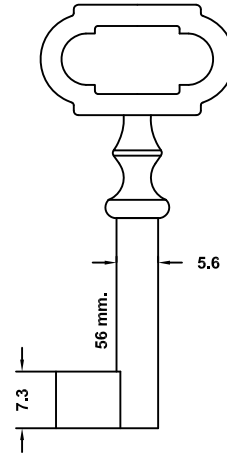

V-2G V-2G CV

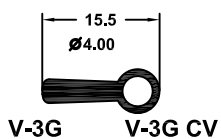
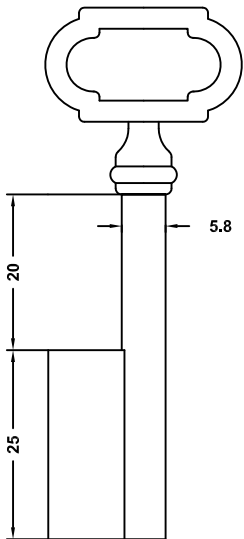

V-3G V-3G CV

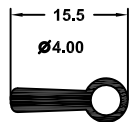
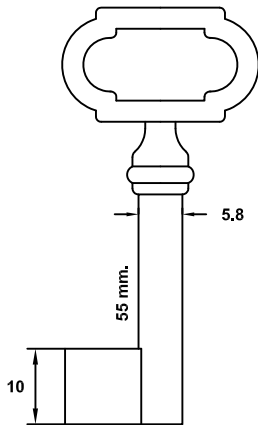

V-4G CV

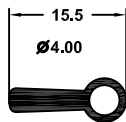
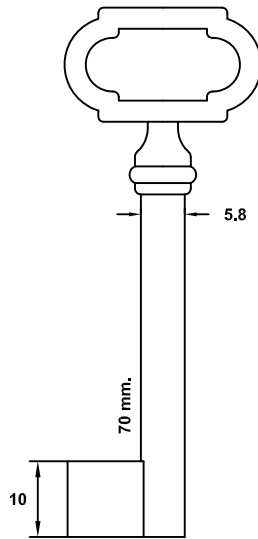

V-5G CV



LLAVES ARTÍSTICAS Y DE ARMARIO ZAMAK

ZAMAKEZKO GILTZAK: ARMAIRUETARAKO ETA ARTISTIKOAK

ZAMAK FURNITURE KEYS

CLES POUR MEUBLES EN ZAMAK

MOBELSCHLÜSSEL AUS ZAMAK



THE KEY TO EXCELLENCE
GLOBALLY UNLOCKING MILLIONS OF DOORS DAILY

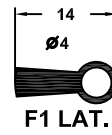
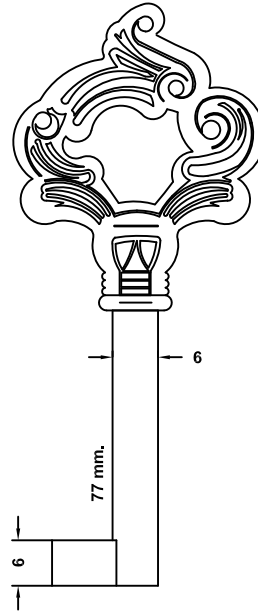
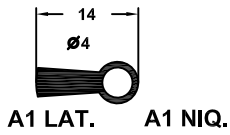
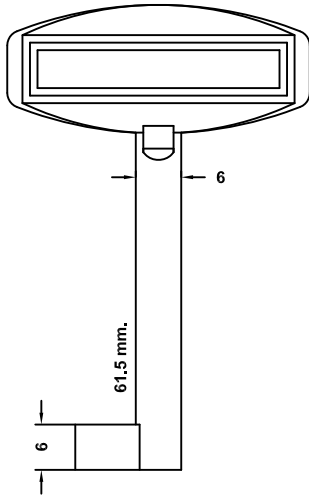

LLAVES PARA CASILLAS Y ASCENSORES

KUTXATILA ETA IGOGAILUENTZAKO GILTZAK

LIFT AND MAIL BOX KEYS

CLES POUR ASCENSEURS ET BOITES A LETTRES

FACHKASTEN-UND LIFTSSCHLÜSSEL

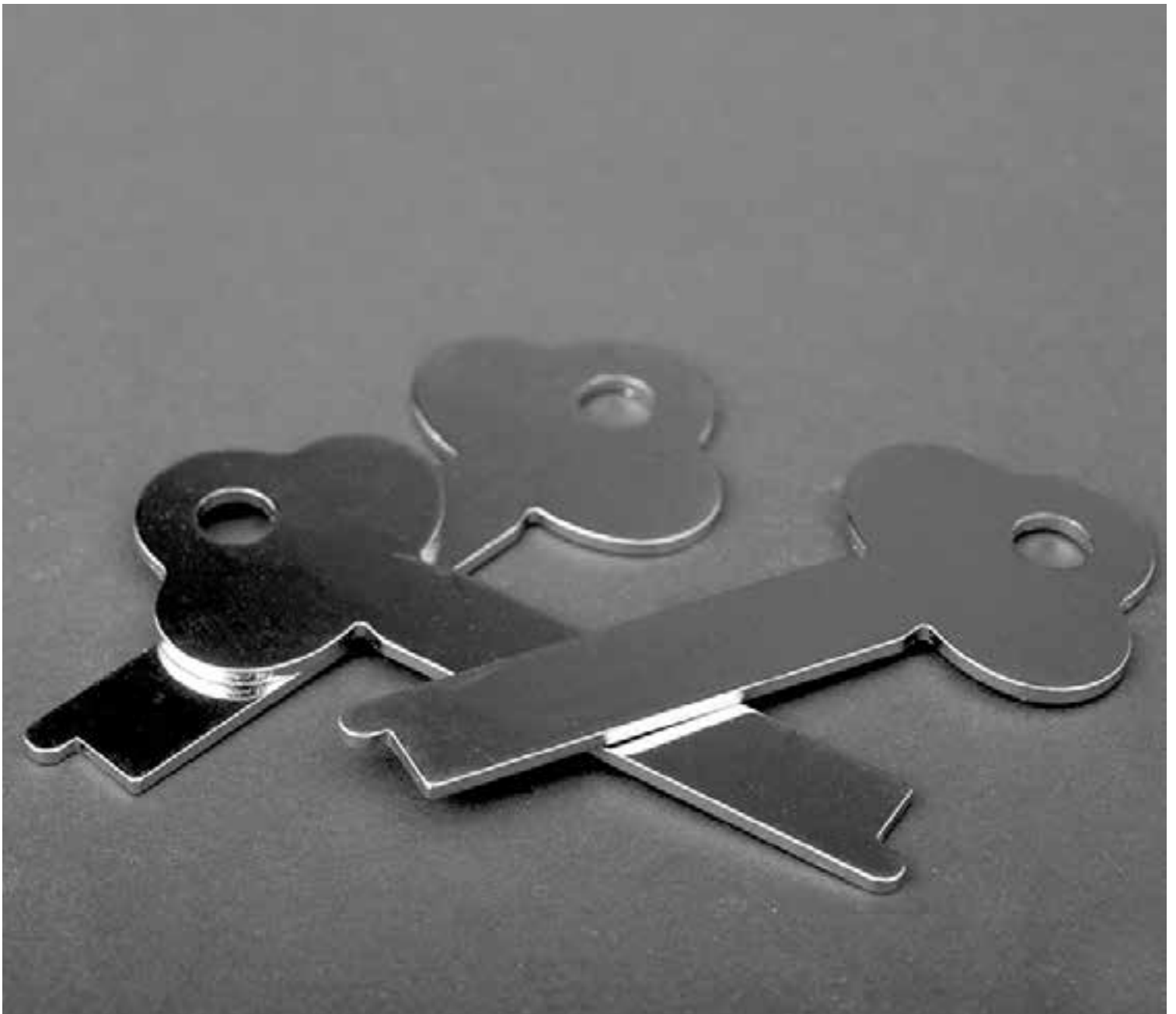

THE KEY TO EXCELLENCE

GLOBALLY UNLOCKING MILLIONS OF DOORS DAILY

PARA-FOR:

DIEBOLD (D)

RIL (E)

SERRETA (E)

URKO (E)

YALE (D-GB)

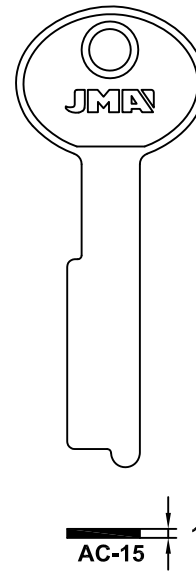
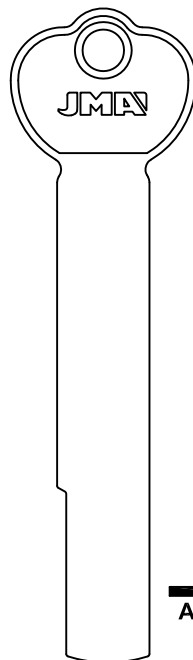
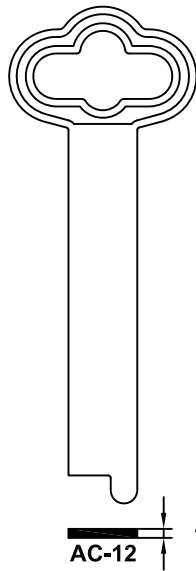
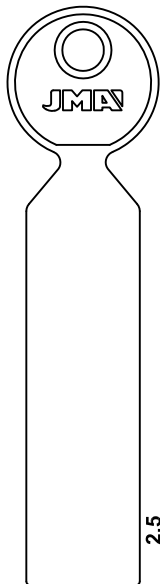

DIEBOLD

RIL

SERRETA

URKO

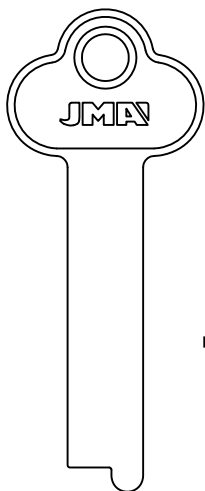

DIE-1

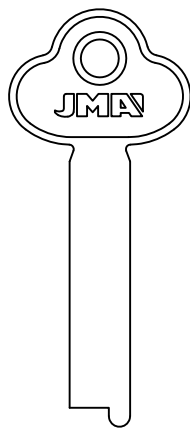

26-M

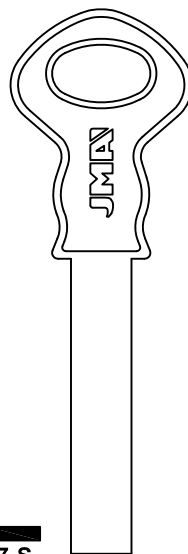

7-S

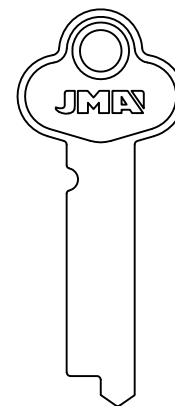

URKO-4

YALE

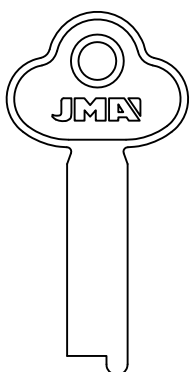

YA-30



AUTOMÓVIL - CAMIONETA

AUTOMOBILA-KAMIONETA

CAR-PICK UP TRUCK

VOITURE-CAMIONNETTE

AUTO-KLEINTRANSPORTER



Tél. 04 73 84 84 94

info@palserviceminute.com

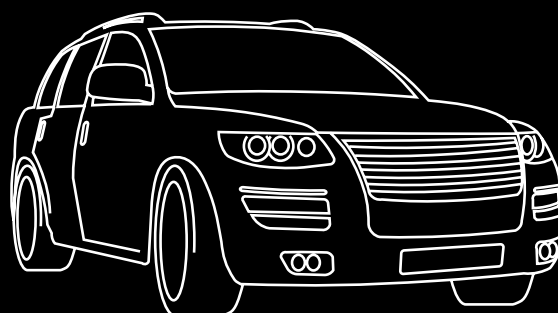

THE KEY TO EXCELLENCE



GLOBALLY UNLOCKING MILLIONS OF DOORS DAILY



AUTOMÓVIL - CAMIONETA



CAR - PICK-UP TRUCKS



AUTOMÓVIL-CAMIONETA

AUTOMOVILA-KAMIONETA • CAR-PICK-UP TRUCKS
VOITURE-CAMIONNETTE • AUTO-KLEINTRANSPORTER

MARCA BRAND	MODELO MODEL			
ABT	GOLF 3	1991-	AU-AH	AU-AH
			AU-AHP	AU-AHP
			VO-2	VO-2
			VO-2P	VO-2P
ACM	10.1 ENDURO	-	NE-15I	RO-15
	10.4 ENDURO	-	NE-15IP	
	OFF 4WD	-		
ACURA (HONDA)	INTEGRA	-1989	HOND-10	HOND-10
	LEGEND	1989-1991	HOND-10P	HOND-10P
	MODELOS	1986-1988		
	INTEGRA	1990-	HOND-15	HOND-15
	VIGOR	1992-	HOND-15P	HOND-15P
	LEGEND	1991-	HOND-17P	HOND-17P
	NSX	1991-1997	HOND-16D HOND-16DP HOND-16DP1	HOND-16D HOND-16DP HOND-16DP1
AIXAM	500-4	-	SIX-3P	SIX-3P
	COUPE	2008		
	CROSSLINE	2007		
	CROSSOVER	2011		
	GTO	2011		
	ROADLINE	2009-2010		
	SCOUTY	2005-2012		
ALFA ROMEO	10 AR 6	-	FI-12	FI-12
	13 AR 6	-	FI-12P	FI-12P
			FI-12P3	FI-12P3
			FI-3D	FI-3D
			FI-3DP3	FI-3DP3
			FI-6I	FI-6I
	30 AR 8	-1986	AF-7I	IMS-3
	35 AR 8	-1986	AF-7IP	IMS-3P
	40 AR 8	-1986	FI-9I	IMS-5
			FI-9IP	IMS-5P
	30 AR 8	1986-	FI-2D	FI-2D
	35 AR 8	1986-	FI-2DP3	FI-2DP3
	40 AR 8	1986-	FI-3D	FI-3D
			FI-3DP1	FI-3DP1
			FI-6I	FI-6I
			FI-6IP1	FI-6IP1
	33	1983-1986	AF-14	AF-14
	164	1987-1995	AF-14P	AF-14P
	164 V6	1987-1995	FI-6I	FI-6I
			FI-6IP4	FI-6IP4
	33	1986-1990	FI-3D	FI-3D
	75 TD	1987-	FI-3DP4	FI-3DP4
	33	1990-	AF-14	AF-14
75	1990-1991	AF-14P	AF-14P	



MARCA BRAND	MODELO MODEL				
ALFA ROMEO	SZ COUPE	1991-			
	75 MILANO	1985-	AF-13	AF-13	
	90	1985-	AF-13P	AF-13P	
	SPIDER	1991-1995			
			90	1984-1985	FI-6I
	145	1994		FI-6IP4	FI-6IP4
				FI-13	FI-13
	155	1992-1995		FI-13P	FI-13P
				FI-13	FI-13
	155 6V	1992-1995	FI-13P	FI-13P	
	155 T.S.	1992-1995	FI-14P	FI-14P	
	1750	-	AF-7I	AF-5D	
	GIULIA 1600	-	AF-7IP	AF-5I	
			NE-25	AF-6D	
				AF-6I	
	2000 BERLINA	-	AF-7I	AF-5D	
	A 11 D	-	AF-7IP	AF-5I	
	A 12 D	-		AF-6D	
	ALFETTA 1.6 1	-		AF-6I	
	ALFETTA 1.8 1	-			
	F 11 D	-			
	F 12 D	-			
	GIULIA DIES.	-			
SPRINT	-				
2000 COUPE	-	SIP-3	AF-5D		
2000 SPIDER	-		AF-5I		
			AF-6D		
			AF-6I		
A 11	-	BH-8	AF-5D		
A 12	-		AF-5I		
F 11	-		AF-6D		
F 12	-		AF-6I		
A 20	-	BH-1	RO-7D		
A 38	-	BH-1P			
ALFA 6	1984-	FI-6I	AF-10		
ALFETTA	1982-1984	FI-6IP4	AF-11		
			AF-12		
ALFASUD	-	AF-7I	AF-5D		
		AF-7IP	AF-5I		
		FI-6I	AF-6D		
		FI-6IP4	AF-6I		
		FI-9I			
		FI-9IP			
		SIP-3			
ALFETTA	1978-1982	AF-7I	AF-10		
ALFETTA 1.6 2	-	AF-7IP	AF-11		
ALFETTA 1.6 G	-		AF-12		



MARCA BRAND	MODELO MODEL			
ALFA ROMEO	ALFETTA 1.8 2	-		
	ALFETTA 1.8 G	-		
	ALFETTA 2.0 G	-		
	GIULIETTA	1979-1981		
	ALFETTA	1984-	FI-6I	AF-10
			FI-6IP4	AF-11
				AF-12
				FI-6I
				FI-6IP4
	ARNA 1.2 L	-	FI-6I	DAT-6
	ARNA 1.2 LS	-	FI-6IP4	DAT-6P
	ARNA 1.3 TI	-		
	DUETTO	-	FI-6I	AF-5D
			FI-6IP4	AF-5I
				AF-6D
				AF-6I
	GIULIA 1300	-	AF-7I	AF-5D
			AF-7IP	AF-5I
			BH-8	AF-6D
			NE-25	AF-6I
	GIULIETTA	1981-	FI-6I	GIOB-3P
	GTV 2.0	1982-1995	FI-6IP4	
	GTV 2.0 6V	1984-1995		
GTV 2.5	1982-1995			
GTV 2.5 6V	1984-1995			
MONTREAL	-	AF-7I	IMS-3	
		AF-7IP	IMS-3P	
			IMS-5	
			IMS-5P	
SPIDER	1970-1989	AF-7I	AF-5D	
		AF-7IP	AF-5I	
		FI-6I	AF-6D	
		FI-6IP4	AF-6I	
		SIP-3		
SPIDER	1990-1991	AF-14	AF-5D	
		AF-14P	AF-5I	
			AF-6D	
			AF-6I	
SPIDER 1300	-	AF-7I	AF-5D	
		AF-7IP	AF-5I	
		BH-8	AF-6D	
			AF-6I	
AMERICAN MOTORS	ALLIANCE	1981-1983	CHR-3	NE-16
	ENCORE	1981-1983	CHR-3P	NE-59P
				VA-10
	ALLIANCE	1984-1985	CHR-3	NE-16
	ENCORE	1984-1985	NE-19	NE-59P
			NE-19P	VA-10
			NE-22P	
	ALLIANCE	1985-1986	CHR-3	BAS-1I
	ENCORE	1985-1986	NE-22P	
	ALLIANCE	1986-1988	NE-19	BAS-1I
ENCORE	1986-1988	NE-19P		



MARCA BRAND	MODELO MODEL			
AMERICAN MOTORS	CHEROKEE	-1990	BAS-1I	BAS-1I
	COMANCHE	-1990	GM-9	
	W.BASE	-1990	GM-9P	
	W.ISLANDER	-1990	GM-J	
	W.LAREDO	-1990	GM-JP	
	W.SAHARA	-1990		
	W.TEXAS	-1990		
	WAGONEER	-1990		
	CHEROKEE	1991-1992	CHR-9	CHR-9
	COMANCHE	1991-1992	CHR-9P	CHR-9P
	MJ COMANCHE	1993-	CHR-10	CHR-10
	XJ CHEROKEE	1993-	CHR-10P	CHR-10P
	YJ WRANGLER	1993-		
	ZJ G.CHEROKEE	1993-		
	MODELOS	1953-1969	BS-1I	BS-1I
	MODELOS	1970-1985	BAS-1I	BAS-1I
	WAGONEER	1991-1992	CHR-9	BAS-1I
			CHR-9P	CHR-9
			GM-9	CHR-9P
			GM-9P	
			GM-J	
			GM-JP	
	ARO DACIA	203	-	BH-1
			BH-1P	
240		1982-1985	BH-1	RO-15
			BH-1P	
240		1985-	NE-15I	RO-15
241		1985-	NE-15IP1	
242		1985-		
243		1985-		
244		1985-		
ISCHIA 10.1		1985-		
ISCHIA 10.4		1985-		
SUPER ISCHIA	1985-			
ASTON MARTIN	LAGONDA	-	FO-E-TC	FO-E-TC
	LAGONDA LIM.	-	FO-E-TCP	FO-E-TCP
	V8 SALOON	-	FO-FR	IN-1
	V8 VANTAGE	-	FO-FRP	OP-WHP
	V8 VANTAGE Z	-	OP-WHP	OP-WYP
	V8 VOLANTE	-	OP-WYP	UN-FP
	V8 VOLANTE C	-		UN-FS
			UN-FT	
AUDI	50 GL	1974-	VO-VB	VO-VB
	50 LS	1974-	VO-VBP	VO-VBP
	80 GLS	1979		
	80 GT	1979		
	60	-		
	100	1973-1977		
	100 L	1973-1977		
	100 LS	1973-1977		
	80	1978-1982	AU-1	AU-1
	100	1978-1982	AU-HV	AU-HV
	200	1978-1982	AU-HVP	AU-HVP
4000	1978-1982	VO-VB	VO-VB	



AUTOMÓVIL - CAMIONETA

CAR - PICK-UP TRUCKS

MARCA BRAND	MODELO MODEL			
AUDI	5000	1978-1982	VO-VBP	VO-VBP
	80	1983-1984	AU-1	AU-1
			AU-HV	AU-HV
			AU-HVP1	AU-HVP1
			VO-HV	VO-HV
			VO-VB	VO-VB
			VO-VBP	VO-VBP
	80	1984-1985	AU-AH	AU-AH
	QUATTRO	1984-1985	AU-AHP1	AU-AHP1
			AU-AN	AU-AN
			AU-ANP	AU-ANP
			VO-2	VO-2
			VO-2P	VO-2P
	80	1985-	AU-AH	AU-AH
	90	1985-	AU-AHP	AU-AHP
	100	1985-	AU-AN	AU-AN
	200	1985-	AU-ANP	AU-ANP
	4000	1985-	VO-2	VO-2
	5000	1985-	VO-2P	VO-2P
	CABRIO	1985-1995		
COUPE	1985-1995			
QUATTRO	1985-			
V8	1985-			
100	1979	NE-1	AU-W	
100 GLS	1979	NE-1P		
100 L	1979			
COUPE GT	1982-1984	AU-1	AU-1	
QUATTRO	1982-1984	AU-HV	AU-HV	
		AU-HVP	AU-HVP	
		VO-HV	VO-HV	
		VO-VB	VO-VB	
		VO-VBP	VO-VBP	
FOX	1973-1977	VO-HV	VO-HV	
		VO-HVP	VO-HVP	
AUSTIN	SHERPA 185	-	LF-BL	UN-1FS
	SHERPA 230	-	LF-RO	UN-FT
	SHERPA 255	-	LF-ROP	
AUTOBIANCHI	A111	-	AF-7I	IMS-3
			AF-7IP	IMS-3P
			AF-8D	IMS-5
			AF-8DP	IMS-5P
			AF-8I	
			AF-8IP	
			AF-9D	
			AF-9DP	
			AF-9I	
			AF-9IP	
	A112	1971-1977	AF-7I	IMS-3
			AF-7IP	IMS-3P
			FI-9I	IMS-5
			FI-9IP	IMS-5P
			SIP-3	
	A112	1978-1981	AF-7I	IMS-3
			AF-7IP	IMS-3P



MARCA BRAND	MODELO MODEL			
AUTOBIANCHI			FO-FR	IMS-5
			FO-FRP	IMS-5P
	A112	1981-1984	AF-7I	IMS-3
			AF-7IP	IMS-3P
			FI-8I	IMS-5
			FI-8IP	IMS-5P
			FI-9I	
			FI-9IP	
	A112	1984-1986	FI-3D	FI-3D
			FI-3DP3	FI-3DP3
			FI-6I	FI-6I
			FI-6IP3	FI-6IP3
				IMS-3
				IMS-3P
				IMS-5
				IMS-5P
	A112 (1.SER)	1969-1971	AF-7I	IMS-3
			AF-7IP	IMS-3P
			AF-8D	IMS-5
			AF-8DP	IMS-5P
		AF-8I		
		AF-8IP		
		AF-9D		
		AF-9DP		
		AF-9I		
		AF-9IP		
		FO-FR		
		FO-FRP		
BIANCHINA	-	FEM-1D	AF-5D	
		FEM-1I	AF-5I	
		FEM-2D	AF-6D	
		FEM-2I	AF-6I	
PRIMULA	-	AF-7I		
		AF-7IP		
		FEM-1D		
		FEM-1I		
		FEM-2D		
		FEM-2I		
	Y10	1986-	FI-1	FI-1
			FI-11	FI-11
			FI-11P	FI-11P
			FI-1P	FI-1P
			FI-1P8	FI-1P8
BEDFORD	MIDI VAN	-	TOYO-14	TOYO-14
	MIDI WAGON	-	TOYO-14P	TOYO-14P
	WINDOW VAN	-		
	RASCAL	-	GM-1P	GM-1P
BELLIER	DIVANE	2004-2006	SIX-3P	SIX-3P
	JADE	2009		
	OPALE	2007-2009		
BENTLEY	CONTINENTAL	-	YA-18D	YA-18D
	EIGHT	-	YA-19D	YA-19D
	TURBO	-		
	MULSANNE	1987-	YA-20I	YA-20I



MARCA BRAND	MODELO MODEL			
BENTLEY			YA-21I	YA-21I
BERTONE	FREECLIMBER	-	DAI-1P	DAI-1P
	SL-CABRIO	-	MIT-12	MIT-12
			MIT-7	MIT-7
			MIT-7P	MIT-7P
BMA	AMICA 250	-	AF-9D	UN-MRN
	AMICA 360 D	-	AF-9DP	
	AMICA 50-125	-	AF-9I	
			AF-9IP	
			FEM-1I	
BMW	524 TD	1984-1986	BM-2	BM-2
	SERIE 7	1984-1986	BM-2P	BM-2P
			BM-HB	BM-HB
			BM-HBP	BM-HBP
	1502	1968-1976	BM-W	BM-B
	1600	1968-1976		HU-SX
	1602	1968-1976		
	1800	1968-1976		
	1802	1968-1976		
	2000	1968-1976		
	2002	1968-1976		
	2000 TOURING	1968	BM-W	BM-W
	2002 TOURING	1979		
	2500	1968-	BM-1P	BM-1P
	2800	1970-1975		
	3000	1970-1975		
	3800	1970-1975		
	BAVARIA	1970-1975		
	SERIE 3	1975-1984	BM-3	BM-3
	SERIE 5	1975-1984	BM-3P	BM-3P
	SERIE 6	1975-1984	BM-HB	BM-HB
	SERIE 7	1975-1984	BM-HBP	BM-HBP
			BM-NB	BM-NB
			BM-NBP	BM-NBP
	SERIE 3	1987-1990	BM-2	BM-2
			BM-2P	BM-2P
			BM-NB	BM-NB
			BM-NBP	BM-NBP
	SERIE 3	1990-1995	BM-4	BM-4
	SERIE 5	1988-1995	BM-5P	BM-5P
	SERIE 7	1988-1995		
	SERIE 8	1988-1995		
CARBODIES	FAIRWAY FX4S	-	LF-RO	IN-4
			LF-ROP	IN-5
CHATENET	BAROODER	2001-2010	SIX-3P	SIX-3P
	CH26	2007		
	CH28	2012		
	CH30	2010		
	CH32	2012		
	MEDIA	2000-2009		
	SPEEDINO	2006-2010		
	STELLA	-		
CHRYSLER	024	1987-	CHR-8	CHR-8
	5.TH AVENUE	-	CHR-8P	CHR-8P



MARCA BRAND	MODELO MODEL			
CHRYSLER	FULL SIZE V.	-		
	LEBARON	1989-		
	NEW YORKER	-		
	ARROW	-	MIT-1I	MIT-1I
	D 50	-	MIT-1IP	MIT-1IP
	PICK UP	-		
	CHALLENGER	-	MIT-2I	MIT-2I
	CONQUEST	-	MIT-2IP	MIT-2IP
	RAIDER	-		
	SAPPORO	-		
	COLT	1993-	MIT-8D	MIT-8D
	VISTA	1993-	MIT-8DP	MIT-8DP
	CONCORDE	1993-	CHR-10	CHR-10
	FULL SIZE V.	1993-	CHR-10P	CHR-10P
	IMPERIAL	1993-		
	NEW YORKER	1993-		
	PICK UP	1993-		
	TOWN & CO.	1993-		
	VANS	-		
	CRICKET	-	LF-SL	LF-SL
			LF-SLP	LF-SLP
	GR. VOYAGER	1996-1997	CHR-14	CHR-14
	STRATUS	1995	CHR-14P	CHR-14P
	VIPER	1995	CHR-15	CHR-15
	VISION	1995	CHR-15P	CHR-15P
	VOYAGER	1995		
	LEBARON VAN.	-	CHR-7	CHR-7
	MOD. USA	1967-1979	CHR-7P	CHR-7P
	MOD. USA	1980-1986		
	OMNI-HORIZON	-		
	RELIANT	1989-		
	TC3-ARIES	-		
	MOD. USA	1990-1992		
CHRYSLER (DODGE)	1800	-		
	400	1985-	CHR-7	CHR-7
	DODGE	1985-1986	CHR-7P	CHR-7P
	RAM 50	-		
	600 CARAVEL.	1985-1989	CHR-8	CHR-8
	CARAVAN	1991-1993	CHR-8P	CHR-8P
	DAKOTA	1991-1993		
	DAYTONA	1991-1993		
	DODGE	1986-1990		
	LANCER	-		
	RAM	1986-		
	SHADOW ES	1991-1992		
	TRAIL DUSTER	1986-		
	CARAVAN	1993-	CHR-10	CHR-10
	DAKOTA	1993-	CHR-10P	CHR-10P
	DAYTONA	1993-		
	INTREPID	1993-		
	RAMCHARGER	1993-		
	SPIRIT	1993-		
	VIPER	1993-		
	COLT	1989-1993	CHR-17	CHR-17



AUTOMÓVIL - CAMIONETA

CAR - PICK-UP TRUCKS

MARCA BRAND	MODELO MODEL				
CHRYSLER (DODGE)	VISTA	1989-1992	MIT-12 MIT-7 MIT-7P	MIT-12 MIT-7 MIT-7P	
	COLT	1993-	MIT-13D	MIT-13D	
	VISTA	1993-	MIT-14D MIT-8D MIT-8DP	MIT-14D MIT-8D MIT-8DP	
	DODGE	-	CHR-7	CHR-7	
	RAMCHARGER	1981-1992	CHR-7P CHR-8 CHR-8P	CHR-7P CHR-8 CHR-8P	
	DODGE	1991-	CHR-9	CHR-9	
	NEON	1995	CHR-9P	CHR-9P	
	SPIRIT	1990-1992			
	VIPER	1990-1992			
	DODGE 400	1989-	CHR-7 CHR-7P		
	DODGE 600	1989-	CHR-8 CHR-8P		
	MONACO	1990-1993		VA-10	
	STEALTH	1991-1993	MIT-12 MIT-7 MIT-7P	MIT-12 MIT-7 MIT-7P	
	CHRYSLER (EAGLE)	D 50	-	MIT-11	MIT-11
		EAGLE	-	NE-19	NE-28
		MEDALLION	-	NE-19P	VA-10
EAGLE		1989-1990	MIT-12 MIT-7 MIT-7P	MIT-12 MIT-7 MIT-7P	
EAGLE		1990-1992		VA-10	
PREMIER		1990-			
EAGLE		1993-	MIT-8D MIT-8DP	MIT-8D MIT-8DP	
SUMMIT		1989-1992	CHR-17	CHR-17	
TALON		1989-	MIT-12 MIT-7 MIT-7P	MIT-12 MIT-7 MIT-7P	
SUMMIT		1993-	MIT-13D MIT-14D MIT-8D MIT-8DP	MIT-13D MIT-14D MIT-8D MIT-8DP	
VISION		1993-1998	CHR-10 CHR-10P	CHR-10 CHR-10P	
CHRYSLER (PLYMOUTH)		ACCLAIM	1990-1992	CHR-9	CHR-9
		PLYMOUTH	1990-	CHR-9P	CHR-9P
		ACCLAIM	1993-	CHR-10	CHR-10
		GRAN VOYAGER	1993-	CHR-10P	CHR-10P
		VOYAGER	1993-		
	COLT VISTA	1989-1992	CHR-17	CHR-17	
	LASER	1989-1992			
	COLT VISTA	1993-1994	MIT-13D MIT-14D	MIT-13D MIT-14D	
	NEON	1995	CHR-14 CHR-14P	CHR-14 CHR-14P	



MARCA BRAND	MODELO MODEL			
CHRYSLER (PLYMOUTH)			CHR-15 CHR-15P	CHR-15 CHR-15P
	PLYMOUTH	1985-1986	CHR-7 CHR-7P	CHR-7 CHR-7P
	PLYMOUTH	1986-1990	CHR-8	CHR-8
	SUNDANCE	1989-	CHR-8P	CHR-8P
	VOYAGER	1991-1992		
	CITROEN	2 CV	1970-	CT-3 CT-3P CT-4P
ACADIANE		-	CT-2P1 CT-3 CT-3P	RO-4D RO-4I
AMI 6		1969-	CT-3	RO-5D
AMI 8		1969-	CT-3P	RO-5I
SM		1970-		
AX		1986-1989	CL-8P	CL-8P
BX		1982-1990	SIX-1 SIX-1P SIX-2 SIX-2P	SIX-1 SIX-1P SIX-2 SIX-2P
AX		1989-1994	NE-36 NE-36P1 SIX-1 SIX-1P SIX-2 SIX-2P	NE-36 NE-36P1 SIX-1 SIX-1P SIX-2 SIX-2P
AX		1994	NE-20P3	NE-20P3
ZX		1994	NE-36	NE-36
AX		1995	SIX-3P2	SIX-3P2
ZX		1995		
AX 14D COME.		-	SIX-1 SIX-1P1	SIX-1 SIX-1P1
AXEL		1984-	CHR-3 CHR-3P NE-22P1	CHR-3 CHR-3P NE-22P1
BERLINGO		1997	SIX-3P1	SIX-3P1
EVASION		1994		
JUMPI		1996-		
BX		1990-	NE-36 NE-36P1 SIX-1 SIX-1P SIX-2 SIX-2P	NE-36 NE-36P1 SIX-1 SIX-1P SIX-2 SIX-2P
C-15 D		-	SIX-1	SIX-1
C-15 E		-	SIX-1P	SIX-1P
VISA		1985-		
ZX		1991-1992		
C-25 FURGON.		-	FI-6I FI-6IP3	FI-6I FI-6IP3
CX		1974-1985	CT-3 CT-3P	AB-5D AB-5I RO-5D



MARCA BRAND	MODELO MODEL			
CITROEN				RO-5I
	CX	1985-	SIX-1 SIX-1P SIX-2 SIX-2P	SIX-1 SIX-1P SIX-2 SIX-2P
	D	-1974	CT-1	RO-5D
	DS	-1974	CT-1P	RO-5I
			CT-3	
			CT-3P	
	DYANE	1967-1980	CT-2	RO-4D
			CT-2P	RO-4I
			CT-2P1	
			CT-3 CT-3P	
	DYANE	1980-	SIX-1	RO-4D
			SIX-1P	RO-4I
			SIX-2	
			SIX-2P	
	G	1970-	CT-3	AB-5D
	GS	1970-	CT-3P	RO-5D
	GSA	1970-		RO-5I
	JUMPER	1996-	FI-11P	FI-11P
	LN	1976-1984	NE-4	VA-6
	LNA	1976-1984	NE-4P1	VA-6P
	LNA	1984-	CHR-3	VA-6
			CHR-3P	VA-6P
			NE-22P1	
MEHARI	1968-	CT-3	RO-4D	
		CT-3P	RO-4I	
		CT-4P		
PLUS	-	FI-12	FI-12	
		FI-12P	FI-12P	
		FI-12P3	FI-12P3	
		FI-3D	FI-3D	
		FI-3DP3	FI-3DP3	
SAXO	1996	SIX-3P	SIX-3P	
SYNERGIE	1994-1997			
XANTIA	1993-			
XM	1990-			
VISA	1979-1985	CHR-3	RO-4D	
		CHR-3P	RO-4I	
		NE-22P1	RO-5D	
		NE-4	RO-5I	
		NE-4P1		
ZX	1992-1994	SIX-1P2	SIX-1P2	
DAEWOO	DAMA	-	DAE-1P	DAE-1P
	LANOS	1997	DAE-4P1	DAE-4P1
	LE MANS	1973-1982	OP-6	OP-6
			OP-7	OP-7
			OP-8	OP-8
			OP-9	OP-9
			OP-BB	OP-BB
OP-EE	OP-EE			



MARCA BRAND	MODELO MODEL			
DAEWOO			OP-FF	OP-FF
	LE MANS	1983-1984	OP-D	OP-D
			OP-DP	OP-DP
			OP-S	OP-S
			OP-SP	OP-SP
	LE MANS	1985-	OP-AB	OP-AB
			OP-ABP	OP-ABP
			OP-BA	OP-BA
			OP-BAP	OP-BAP
			OP-J OP-JP	OP-J OP-JP
LEGANZA	1997	DAE-4D	DAE-4D	
		DAE-4DP1	DAE-4DP1	
NUBIRA	1997-2000	DAE-3D	DAE-3D	
TACUMA	2000-2002	DAE-3DP1	DAE-3DP1	
RACER	-	DAE-2DP	DAE-2DP	
DAF	46 L	-		FO-TC
	46 STATIONCA	-		
	46 SUPER L	-		
	66 GL	-		
	66 COUPE	-		
	66 L	-		
	66 MARATHON	-		
	66 SL	-		
	66 STATIONCA	-		
	95 XF	1997	CHR-3P	CHR-3P
DAIHATSU	4 WD TURBO	-	TOYO-K1	
	PIONEER 2800	-	TOYO-K1P	
	TAFT 1600 D.	-		
	TAFT F10	-		
	TAFT F20	-		
	TAFT F201600	-		
	TAFT F50	-		
	TAFT F55	-		
	APPLAUSE	1990-	DAI-1P	DAI-1P
	CHARADE	1990-		
	FEROZA	1988-		
	ROCKY	1990-		
	SPORTTRACK	1991-		
	SX 228	1991-		
	CHARADE	1977-1983	TOYO-K1	TOYO-K1
CHARMANT	1983-	TOYO-K1P	TOYO-K1P	
CUORE L55	1976-1998			
CUORE L60	1976-1998			
MIRA	1976-			
CHARADE	1983-1989	TOYO-3	TOYO-3	
FOURTRAK 4WD	1984-1988	TOYO-3P	TOYO-3P	
ROCKY	1984-1988	TOYO-8	TOYO-8	
		TOYO-8P	TOYO-8P	
CUORE 850	1986-1991	TOYO-3	TOYO-3	
ROCKY	1989-1990	TOYO-3P	TOYO-3P	
DAIMLER	DOUBLE SIX C	-1987	FO-FR	CENT-3D
	LIMOUSINE	-1987	FO-FRP	FO-5
	SOVEREIGN V.	-1987		



AUTOMÓVIL - CAMIONETA

CAR - PICK-UP TRUCKS

MARCA BRAND	MODELO MODEL			
DAIMLER	SOVEREIGN3.4	-1987		
	SOVEREIGN4.2	-1987		
	MODELOS	1990-1994	JAU-1P	JAU-1P
DE LOREAN	MODELOS	1980-1981	NE-10	LF-WR
			NE-10P	
DELTA MOTOR	CRUISER	-	TOYO-K1	TOYO-K1
	MINI WHEEL	-	TOYO-K1P	TOYO-K1P
	EXPLORER	-	TOYO-K1	DAT-6
			TOYO-K1P	DAT-6P
DISALCAR	IN 32 4X4	-	AF-7I	IMS-3
	IN 50 R 4X4	-	AF-7IP	IMS-3P
	IN 60 4X4	-		IMS-5
	IN 70 B 4X4	-		IMS-5P
	IN 70 CR 4X4	-		
	R 26 4x4	-	BH-4	
EBRO	F 275	-	LMP-1	IMS-3
	F 350	-	LMP-1P	IMS-3P
			STS-2D	IMS-5
			STS-2DP	IMS-5P
	L 35	-	LMP-1	CL-2I
	L 35/1	-	LMP-1P	CL-3I
	L 60	-	NE-3	FO-OA
	L 80	-	NE-3P	FO-PN
			NE-3P1	
			NE-3P2	
	PATROL	1983-	DAT-6	DAT-6
	VANETTE	1983-	DAT-6P	DAT-6P
	TRADE 2.0	1983-	STS-2D	IMS-3
	TRADE 2.8	1983-	STS-2DP	IMS-3P
			IMS-5	
			IMS-5P	
FERRARI	208	1975-1982	NE-25	IMS-3
	308	1973-1975		IMS-3P
	365	1968-		IMS-5
	DINO 246	-		IMS-5P
	208	1982-	NE-25	AF-5D
	308	1975-		AF-5I
	328	1985-		AF-6D
				AF-6I
	208 GTS	1982	AF-7IP1	
	348	1984-	FI-6I	FI-6I
	F 40	1984-	FI-6IP	FI-6IP
	MONDIAL	1984-	FI-6IP2	FI-6IP2
	TESTA ROSSA	1984-	FI-6IP3	FI-6IP3
	400	1976-	HU-1	AF-5D
	412	1976-	NE-25	AF-5I
	BB 512	1976-		AF-6D
				AF-6I
	GTO	1984	NE-25	AF-6D
	MONDIAL 8	1982	AF-7I	AF-5D
		AF-7IP	AF-5I	
		AF-7IP1	AF-6D	
			AF-6I	
FIAT	124	1966-	AF-7I	IMS-3



MARCA BRAND	MODELO MODEL			
FIAT			AF-7IP	IMS-3P
			AF-9D	IMS-5
			AF-9DP	IMS-5P
			FEM-1D	
			FEM-1I	
			FEM-2D	
			FEM-2I	
			FO-FR	
			FO-FRP	
			SIP-2	
	125	-	AF-7I	IMS-3
			AF-7IP	IMS-3P
			AF-9D	IMS-5
			AF-9DP	IMS-5P
			FO-FR	
			FO-FRP	
			SIP-3	
	126	-	AF-7I	IMS-3
			AF-7IP	IMS-3P
		AF-9D	IMS-5	
		AF-9DP	IMS-5P	
		FI-3D		
		FI-3DP2		
		FI-9I		
		FI-9IP		
		FO-FR		
		FO-FRP		
		SIP-3		
126 BIS	1987-1992	FI-3D	IMS-3	
126 UP	1987-1992	FI-3DP2	IMS-3P	
		FI-3DP3	IMS-5	
		FI-6I	IMS-5P	
		FI-6IP2		
127	1973-	AF-7I	IMS-3	
		AF-7IP	IMS-3P	
		FI-8I	IMS-5	
		FI-8IP	IMS-5P	
		FI-9I		
		FI-9IP		
		FO-FR		
		FO-FRP		
		SIP-3		
127	1983-	AF-7IP1		
		FI-8IP1		
128	1969-	AF-7I	IMS-3	
		AF-7IP	IMS-3P	
		AF-9D	IMS-5	
		AF-9DP	IMS-5P	
		FI-9I		
		FI-9IP		
		FO-FR		
		FO-FRP		
		SIP-2		
		SIP-3		
130	1969-	AF-7I	IMS-3	



MARCA BRAND	MODELO MODEL			
FIAT			AF-7IP	IMS-3P
			SIP-3	IMS-5
				IMS-5P
	131	1973-1980	AF-7I	IMS-3
			AF-7IP	IMS-3P
			AF-8I	IMS-5
			AF-8IP	IMS-5P
			AF-9I	
			AF-9IP	
	131	1981-	FI-2D	FI-3D
		FI-2DP3	FI-3DP2	
		FI-3D	FI-6I	
		FI-3DP2	FI-6IP	
		FI-6I		
		FI-6IP		
132	1973-	AF-7I	IMS-3	
		AF-7IP	IMS-3P	
		FI-8I	IMS-5	
		FI-8IP	IMS-5P	
147	1976-	FI-8I	IMS-3	
148	1976-	FI-8IP	IMS-3P	
		FI-8IP1	IMS-5	
		FI-9I	IMS-5P	
		FI-9IP		
500	1964-	AF-9D	AF-5D	
		AF-9DP	AF-5I	
		FEM-1D	AF-6D	
		FEM-1I	AF-6I	
		FEM-2D		
		FEM-2I		
		FO-FR		
		FO-FRP		
600	1955-	FEM-1D	AF-5D	
1300	-	FEM-1I	AF-5I	
		FEM-2D	AF-6D	
		FEM-2I	AF-6I	
850	1964-	AF-7I	AF-5D	
		AF-7IP	AF-5I	
		FEM-1D	AF-6D	
		FEM-1I	AF-6I	
		FEM-2D		
		FEM-2I		
		FO-FR		
		FO-FRP		
		NE-3		
		NE-3P		
		NE-3P2		
1100	1956-	FEM-1D	AF-4D	
		FEM-1I	AF-4I	
		FEM-2D	AF-5D	
		FEM-2I	AF-5I	
			AF-6D	
			AF-6I	



MARCA BRAND	MODELO MODEL			
FIAT	1500	1967-	FEM-1D	AF-5D
			FEM-1I	AF-5I
			FEM-2D	AF-6D
			FEM-2I	AF-6I
			SIP-2	
	1800	1967-	SIP-2	AF-5D
	2100	1967-		AF-5I
	2300	1967-		AF-6D
				AF-6I
	ARGENTA	1981-	FI-2D	FI-2D
		FI-2DP3	FI-2DP3	
		FI-3D	FI-3D	
		FI-3DP2	FI-3DP2	
CINQUECENTO	1992-1997	FI-11	FI-11	
DUCATO	1994	FI-11P	FI-11P	
COUPE	1994-1995	FI-13	FI-13	
TIPO	1988-	FI-13P	FI-13P	
CROMA	1985-1995	FI-10	FI-11	
		FI-10P	FI-11P	
		FI-11		
		FI-11P		
DINO	-	FO-FR	IMS-3	
		FO-FRP	IMS-3P	
		SIP-2	IMS-5	
			IMS-5P	
DUNA	1987-1991	FI-1	FI-1	
PANDA	1986-1991	FI-1P	FI-1P	
RITMO	1984-1986			
STRADA	1984-1986			
DUNA	1992-	FI-1	FI-1	
PANDA	1992-1995	FI-11	FI-11	
UNO	1983-	FI-11P	FI-11P	
		FI-1P	FI-1P	
FIORINO	-	AF-7I	IMS-3	
		AF-7IP	IMS-3P	
		AF-9D	IMS-5	
		AF-9DP	IMS-5P	
		AF-9I		
		AF-9IP		
		FI-8I		
		FI-8IP		
		FI-9I		
		FI-9IP		
PANDA	1980-1985	FI-7I	IMS-3	
		FI-8I	IMS-3P	
		FI-8IP	IMS-5	
		FI-8IP1	IMS-5P	
		FI-9I		
		FI-9IP		
PUNTO	1993-1995	FI-13	FI-13	
		FI-13P1	FI-13P1	
REGATA	1983-	FI-1	FI-1	
		FI-10	FI-11	
		FI-10P	FI-11P	



AUTOMÓVIL - CAMIONETA

CAR - PICK-UP TRUCKS

MARCA BRAND	MODELO MODEL			
FIAT			FI-11	FI-1P
			FI-11P	
			FI-1P	
	RITMO	1978-1983	FI-3D	FI-3D
			FI-3DP	FI-3DP
			FI-3DP2	FI-3DP2
			FI-6I	FI-6I
			FI-6IP	FI-6IP
	SCUDO	1995-1997	SIX-3P1	SIX-3P1
	ULYSSE	1994		
	SPIDER EURO.	-	AF-7I	AF-5D
			AF-7IP	AF-5I
				AF-6D
				AF-6I
	STRADA	1979-1982	FI-7I	FI-7I
			FI-8I	FI-8I
			FI-8IP	FI-8IP
	STRADA	1982-1984	FI-3D	FI-3D
			FI-3DP	FI-3DP
			FI-6I	FI-6I
		FI-6IP	FI-6IP	
TEMPRA	1989-1995	FI-13	FI-13	
		FI-13P	FI-13P	
		FI-14P	FI-14P	
X 1/9	1972-	AF-7I	IMS-3	
		AF-7IP	IMS-3P	
			IMS-5	
			IMS-5P	
FIAT (ARGENTINA)	128	-	NE-4	NE-46
			NE-4P	
	133	-	NE-3	
	600	-	NE-3P	
			NE-3P2	
	147	-	NE-4	
			NE-4P	
	DUNA	1987-1991	FI-1	FI-1
			FI-1P	FI-1P
	DUNA	1992-	FI-1	FI-1
	UNO	1983-	FI-11	FI-11
			FI-11P	FI-11P
			FI-1P	FI-1P
	REGATTA	1983-	FI-1	FI-1
			FI-10	FI-11
			FI-10P	FI-11P
			FI-11	FI-1P
			FI-11P	
			FI-1P	
	SPAZIO	-	AF-7I	IMS-3
		AF-7IP	IMS-3P	
		FI-8I	IMS-5	
		FI-8IP	IMS-5P	
		FI-9I		
		FI-9IP		



MARCA BRAND	MODELO MODEL			
FIAT (ARGENTINA)			FO-FR	
			FO-FRP	
			SIP-3	
	TEMPRA	-	FI-13	FI-13
		FI-13P	FI-13P	
FIAT (BRASIL)	ELBA	1992-	FI-1	FI-1
	PREMIO	1992-	FI-11	FI-11
	UNO	1983-	FI-11P	FI-11P
		FI-1P	FI-1P	
	PALIO	1996-1997	FI-13P7	FI-13P7
FIAT (TURQUIA)	131	1973-1980	AF-7I	IMS-3
			AF-7IP	IMS-3P
			AF-8I	IMS-5
			AF-8IP	IMS-5P
			AF-9I	
			AF-9IP	
	131	1981-	FI-2D	FI-3D
			FI-2DP3	FI-3DP2
			FI-3D	FI-6I
			FI-3DP2	FI-6IP
			FI-6I	
			FI-6IP	
	SERCE	-	AF-7I	IMS-3
			AF-7IP	IMS-3P
			AF-9D	IMS-5
			AF-9DP	IMS-5P
			FEM-1D	
		FEM-1I		
		FEM-2D		
		FEM-2I		
		FO-FR		
		FO-FRP		
		SIP-2		
TEMPRA	1989-	FI-13	FI-13	
		FI-13P	FI-13P	
		FI-14P	FI-14P	
FIAT IVECO	131 D MAR.	1976-	AF-7I	IMS-3
			AF-7IP	IMS-3P
				IMS-5
				IMS-5P
	180	-1989		
	190	-1989		
	238	-	AF-7I	AF-5D
			AF-7IP	AF-5I
			AF-9D	AF-6D
			AF-9DP	AF-6I
		AF-9I		
		AF-9IP		
900 E	1980-	FI-8I	AF-5D	
		FI-8IP	AF-5I	
			AF-6D	
			AF-6I	
900 T	1976-	AF-7I	AF-5D	



MARCA BRAND	MODELO MODEL			
FIAT IVECO			AF-7IP	AF-5I
			AF-8D	AF-6D
			AF-8DP	AF-6I
			AF-8I	
			AF-8IP	
			AF-9D	
			AF-9DP	
			AF-9I	
			AF-9IP	
	DAILY 30	-1984	AF-7I	IMS-3
	DAILY 35	-1984	AF-7IP	IMS-3P
	DAILY 40	-1984	FI-9I	IMS-5
	DAILY 50	-1984	FI-9IP	IMS-5P
	DAILY 30	1985-1988	FI-2D	FI-2D
	DAILY 35	1985-1988	FI-2DP3	FI-2DP3
	DAILY 40	1985-1988	FI-3D	FI-3D
	DAILY 50	1985-1988	FI-3DP1	FI-3DP1
			FI-6I	FI-6I
			FI-6IP1	FI-6IP1
	DAILY 30	1989-1991	FI-11	FI-11
	DAILY 35	1989-1991	FI-11P	FI-11P
	DAILY 40	1989-1991		
	DAILY 45	1989-1991		
	DAILY 49	1989-1991		
	DAILY 50	1989-1991		
	FIORINO	1988-1996		
	MARENGO R.	1985-1996		
	PANDA	-1994		
	PENNY	-1991		
	UNO	-1991		
	DUCATO 10	-1988	FI-12	FI-12
	DUCATO 13	-1988	FI-12P1	FI-12P1
DUCATO MAXI	-1988	FI-12P3	FI-12P3	
		FI-3D	FI-3D	
		FI-3DP3	FI-3DP3	
		FI-6I	FI-6I	
		FI-6IP3	FI-6IP3	
DUCATO 10	1989-1996	FI-3D	FI-3D	
DUCATO 14	1989-1996	FI-3DP3	FI-3DP3	
DUCATO 4x4	1989-1996	FI-6I	FI-6I	
DUCATO MAX	1989-1996	FI-6IP3	FI-6IP3	
FIORINO	-1982	AF-9D	IMS-3	
		AF-9DP	IMS-3P	
		AF-9I	IMS-5	
		AF-9IP	IMS-5P	
		FI-9I		
		FI-9IP		
FIORINO	1983-1987	AF-7I	IMS-3	
		AF-7IP	IMS-3P	
		FI-8IP1	IMS-5	
		FI-9I	IMS-5P	
		FI-9IP		
TALENTO	-	FI-6I	FI-6I	
		FI-6IP	FI-6IP	



MARCA BRAND	MODELO MODEL			
FORD	CAPRI	-	FO-E-TC	FO-E-TC
			FO-E-TCP	FO-E-TCP
			FO-TC	FO-TC
			FO-TX	FO-TX
			FO-TXP	FO-TXP
				FO-XR
	CARGO	-	LF-WR	LF-WR
			NE-11	
			NE-11P	
			NE-24	
			NE-24P	
	CARGO	1987-1990	NE-11	LF-WR
			NE-11P	
	CARGO	1990-	NE-11	NE-11
			NE-11P	NE-11P
	CONSUL	-	FO-E-TC	FO-E-TC
	CORTINA	-	FO-E-TCP	FO-E-TCP
			FO-TC	FO-TC
				FO-XR
	ESCORT	-1986	FO-E-TC	FO-E-TC
	FIESTA	-1988	FO-E-TCP	FO-E-TCP
			FO-TC	FO-TC
			FO-TX	FO-TX
			FO-TX1	FO-TX1
			FO-TX1P	FO-TX1P
			FO-TX2	FO-TX2
			FO-TX2P	FO-TX2P
			FO-TXP	FO-TXP
	ESCORT	1986-1988	FO-4P	FO-4P
	GRANADA	1986-		
	ORION	1986-1988		
	SCORPIO	1986-1988		
SIERRA	1986-1988			
ESCORT	1989-1995	FO-6P	FO-6P	
FIESTA	1988-1995			
MONDEO	1993-1995			
ORION	1988-			
SCORPIO	1988-1990			
SCORPIO	1990-1995			
SIERRA	1988-1990			
SIERRA	1990-			
ESCORT VAN	-	FO-E-TC	FO-E-TC	
		FO-E-TCP	FO-E-TCP	
		FO-TX	FO-TX	
		FO-TXP	FO-TXP	
GRANADA	-1986	FO-E-TC	FO-E-TC	
ORION	-1986	FO-E-TCP	FO-E-TCP	
SIERRA	-1986	FO-TX	FO-TX	
		FO-TX1	FO-TX1	
		FO-TX1P	FO-TX1P	
		FO-TX2	FO-TX2	
		FO-TX2P	FO-TX2P	
		FO-TXP	FO-TXP	



AUTOMÓVIL - CAMIONETA

CAR - PICK-UP TRUCKS

MARCA BRAND	MODELO MODEL			
FORD	MAVERICK	1993-1995	FO-10P	FO-10P
	PROBE	1993-1996	FO-9D	FO-9D
			FO-9DP	FO-9DP
	TAURUS	-	FO-E-TC	FO-E-TC
			FO-E-TCP	FO-E-TCP
	TRANSIT 100D	-	FO-TC	FO-PRL
	TRANSIT F.	-1986	FO-E-TC	UN-FT
			FO-E-TCP	UN-TF
			FO-TX	
			FO-TX1	
			FO-TX1P	
			FO-TX2	
			FO-TX2P	
			FO-TXP	
		TRANSIT F.	1986-	FO-22P
			FO-4P	FO-4P
FORD (ARGENTINA)	ESCORT	-1986	FO-E-TC	FO-E-TC
			FO-E-TCP	FO-E-TCP
			FO-TC	FO-TC
			FO-TX	FO-TX
			FO-TX1	FO-TX1
			FO-TX1P	FO-TX1P
			FO-TX2	FO-TX2
			FO-TX2P	FO-TX2P
			FO-TXP	FO-TXP
	ESCORT	1986-1988	FO-4P	FO-4P
	SIERRA	1986-1988		
	ESCORT	1988-1995	FO-6P	FO-6P
	FIESTA	1995-1996		
	MONDEO	1995-1996		
	SIERRA	1988-1990		
	SIERRA	1990-		
	ESCORT VAN	-	FO-E-TC	FO-E-TC
			FO-E-TCP	FO-E-TCP
			FO-TX	FO-TX
			FO-TXP	FO-TXP
FALCON	-	FO-2	FO-2	
PICK UP	-1993			
GALAXI	1996	FO-17P	FO-17P	
GALAXY	-1996	FO-FHP	FO-FHP	
		VO-HV	VO-HV	
		VO-HVP	VO-HVP	
PICK UP	1993-1994	FO-3D	FO-3D	
		FO-3DP	FO-3DP	
		VO-HV		
		VO-HVP		
PICK-UP	1995-1996	FO-11D	FO-11D	
SIERRA	-1986	FO-E-TC	FO-E-TC	
		FO-E-TCP	FO-E-TCP	
		FO-TX	FO-TX	
		FO-TX1	FO-TX1	
		FO-TX1P	FO-TX1P	
		FO-TX2	FO-TX2	



MARCA BRAND	MODELO MODEL			
FORD (ARGENTINA)			FO-TX2P	FO-TX2P
			FO-TXP	FO-TXP
	TAURUS	-	FO-TX	FO-TX
			FO-TXP	FO-TXP
FORD (AUSTRALIA)	CAPRI	-1978	FO-D	FO-TC
			FO-TC	FO-XL
	CAPRI	1978-	FO-2	FO-2
			FO-TX	FO-TX
			FO-TXP	FO-TXP
	EXPLORER	1996-1997	FO-15D	FO-15D
	TAURUS	1996-1997	FO-15DP	FO-15DP
	TAURUS WAGON	1996-1997		
	FESTIVA	1993-1994	KI-1D	KI-1D
			KI-1DP	KI-1DP
	FESTIVA	1994	FO-12	FO-12
			FO-12P	FO-12P
	LASER	1988-1990	FO-14DP	FO-14DP
	LASER	1990-1993	FO-13DP	FO-13DP
	TELSTAR	-	MAZ-2D	MAZ-2D
		MAZ-2DP	MAZ-2DP	
FORD (BRASIL)	CORCEL	-	FO-3D	FO-3D
	DEL REY	-	FO-3DP	FO-3DP
	ESCORT	-1986	FO-E-TC	FO-E-TC
			FO-E-TCP	FO-E-TCP
			FO-TC	FO-TC
			FO-TX	FO-TX
			FO-TX1	FO-TX1
			FO-TX1P	FO-TX1P
			FO-TX2	FO-TX2
			FO-TX2P	FO-TX2P
			FO-TXP	FO-TXP
	ESCORT	1986-1988	FO-4P	FO-4P
	ESCORT	1988-1995	FO-6P	FO-6P
	ESCORT VAN	-	FO-E-TC	FO-E-TC
	SIERRA	-	FO-E-TCP	FO-E-TCP
VERONA	-	FO-TX	FO-TX	
		FO-TXP	FO-TXP	
PICK-UP	1995-1996	FO-3P	FO-3P	
VARIOS	1996-	FO-17P	FO-17P	
FORD (SOUTH AFRICA)	SAPPHIRE	1990-	FO-6P	FO-6P
	SIERRA	1988-1990		
	SIERRA	1990-		
	SIERRA	-1986	FO-E-TC	FO-E-TC
			FO-E-TCP	FO-E-TCP
			FO-TX	FO-TX
		FO-TX1	FO-TX1	
		FO-TX1P	FO-TX1P	
		FO-TX2	FO-TX2	
		FO-TX2P	FO-TX2P	
		FO-TXP	FO-TXP	
SIERRA	1986-1988	FO-4P	FO-4P	
FORD (USA)	AEROSTAR	1986-1991	FO-20D	FO-20D
			FO-8D	FO-8D
	AEROSTAR	1991-1996	FO-11D	FO-1



MARCA BRAND	MODELO MODEL			
FORD (USA)	EXPLORER	1991-1996		
	TAURUS S.	1991-1996		
	T-BIRD S.	1991-		
	AEROSTAR	1996-1997	FO-15D	FO-15D
	BRONCO PICK	1996-1997	FO-15DP	FO-15DP
	EXPLORER	1996-1997		
	TAURUS	1996-1997		
	TAURUS WAGON	1996-1997		
	ASPIRE	1994	FO-12 FO-12P	FO-12 FO-12P
	BRONCO	1967-1989	FO-2	FO-1
	CROWN	1967-1989		
	ESCORT	1981-1986		
	MUSTANG	1967-1998		
	T-BIRD	1967-1984		
	TEMPO GL	1983-1986		
	TEMPO GLS	1983-1986		
	VICTORIA	1967-1989		
	CONCOURSE	1995	FO-1	FO-1
	CONTOUR	1995-1997	FO-8D	FO-8D
	CROWN	1990-1998	FO-11D	FO-11D
	SABLE	1990-	FO-20D	FO-20D
	TAURUS	1990-1996		
	T-BIRD	1986-1991		
	TEMPO GL	1986-1991		
	TEMPO GLS	1986-1991		
	VICTORIA	1990-1998		
	ESCORT	1990-1995	FO-8D	FO-8D
	SABLE	1987-1989	FO-8DP	FO-8DP
	TAURUS	1986-1989		
	FESTIVA	1987-1989	MAZ-6D	MAZ-6D
	PROBE	1987-1989	MAZ-6DP	MAZ-6DP
	FESTIVA	1990-	FO-14DP FO-7P	
FIESTA	-1979	FO-TC LF-SL	FO-TC LF-SL	
FIESTA	1979-1984	FO-TX	FO-TX	
MERKUR	1985-1989	FO-TXP	FO-TXP	
XR4 TI	1985-1989			
MERKUR	1990-1992	FO-14DP	FO-14DP	
PROBE	1990-1992	FO-7P	FO-7P	
PROBE	1993-1996	FO-9D FO-9DP	FO-9D FO-9DP	
SCORPIO	1987	FO-22P FO-4P	FO-22P FO-4P	
SCORPIO	1988-	FO-6P	FO-6P	
FORD (USA) (LINCOLN)	CONTINENTAL	1967-1984	FO-2	FO-1
	CONTINENTAL	1985-1991	FO-20D	FO-20D
	CONTINENTAL	1991-1998	FO-11D	FO-11D
	MARK SERIES	1985-1991	FO-11D FO-20D	FO-11D FO-20D
FORD (USA) (MERCURY)	CAPRI	1970-1971	FO-D	FO-XL
	CAPRI	1978-1983		



MARCA BRAND	MODELO MODEL			
FORD (USA) (MERCURY)	CAPRI	1972-1978	FO-E-TC FO-E-TCP FO-TC	FO-E-TC FO-E-TCP FO-TC
	CAPRI	1983-1991	FO-2	FO-2
	MERCURY	-1993		
	CAPRI	1991-	FO-14DP	FO-14DP
	TRACER	1987-1990	FO-7P	FO-7P
	COUGAR	1967-1984	FO-2	FO-1
	MARQUIS	1967-1989		
	TOPAZ	1983-1985		
	COUGAR	1990-	FO-11D	FO-11D
	MARQUIS	1991-	FO-20D	FO-20D
	TOPAZ	1990-		
	G.MARQUIS	1993-1998	FO-8D	FO-8D
	MERCURY	1993-1996	FO-8DP1	FO-8DP1
	SABLE	1993-1996		
	MYSTIQUE	1995-1997	FO-8D	FO-8D
	SABLE GS/LS	1996-1997	FO-15D FO-15DP	FO-15D FO-15DP
	TRACER	1990-	FO-8D FO-8DP FO-8DP1	FO-8D FO-8DP FO-8DP1
FREIGHTLINER	MODELO	1970	YA-8D	YA-8D
GM (BUICK)	3.8 P.AVENUE	1992-		GM-12
	LESABRE	1991-1996		GM-12P
	REATA	1992-		GM-H
	RIVIERA	1992-1995		GM-HP
	CENTURY	1991-1997	GM-8	GM-12
	MODELOS	1981	GM-8P GM-E GM-EP	GM-12P GM-H GM-HP
	LESABRE	1996-1997		GM-14
	ROADMASTER	1996-1997		GM-14P GM-25 GM-25P
	MODELOS	1935-1966	BAS-1I	BAS-1I
	MODELOS	1966	GM-6	GM-6
	MODELOS	1967	GM-6P	GM-6P
	MODELOS	1971	GM-A	GM-A
	MODELOS	1975	GM-AP	GM-AP
	MODELOS	1986		
	MODELOS	1968	GM-7	GM-7
	MODELOS	1972	GM-7P GM-C GM-CP	GM-7P GM-C GM-CP
	MODELOS	1969	GM-8	GM-8
MODELOS	1973	GM-8P GM-E GM-EP	GM-8P GM-E GM-EP	
MODELOS	1970	GM-9	GM-9	
MODELOS	1974	GM-9P	GM-9P	
MODELOS	1978	GM-J GM-JP	GM-J GM-JP	
MODELOS	1976	GM-7	GM-11	



AUTOMÓVIL - CAMIONETA

CAR - PICK-UP TRUCKS

MARCA BRAND	MODELO MODEL			
GM (BUICK)			GM-7P	GM-11P
			GM-C	GM-7
			GM-CP	GM-7P
				GM-C
				GM-CP
				GM-D
				GM-DP
	MODELOS	1977	GM-8	GM-12
			GM-8P	GM-12P
			GM-E	GM-8
			GM-EP	GM-8P
				GM-E
				GM-EP
				GM-H
				GM-HP
	MODELOS	1979	GM-6	GM-10
			GM-6P	GM-10P
			GM-A	GM-6
			GM-AP	GM-6P
				GM-A
				GM-AP
				GM-B
				GM-BP
	MODELOS	1980	GM-7	GM-11
			GM-7P	GM-11P
		GM-C	GM-D	
		GM-CP	GM-DP	
MODELOS	1982	GM-9	GM-13	
		GM-9P	GM-13P	
		GM-J	GM-K	
		GM-JP	GM-KP	
MODELOS	1983	GM-6	GM-10	
		GM-6P	GM-10P	
		GM-A	GM-B	
		GM-AP	GM-BP	
MODELOS	1984	GM-6	GM-10	
MODELOS	1985	GM-6P	GM-10P	
		GM-7	GM-7	
		GM-7P	GM-7P	
		GM-A	GM-B	
		GM-AP	GM-BP	
		GM-C	GM-C	
		GM-CP	GM-CP	
REGAL	1988-1990	GM-19P		
REGAL	1991-	GM-20P		
RIVIERA	1995	GM-14	GM-14	
SKYLARK	1994	GM-14P	GM-14P	
		GM-25	GM-25	
		GM-25P	GM-25P	
RIVIERA 3.8V	1989-1990		GM-11	
			GM-11P	
			GM-D	
			GM-DP	
SKYLARK	1992-1993	GM-22	GM-22	



MARCA BRAND	MODELO MODEL			
GM (BUICK)			GM-22P	GM-22P
			GM-23	GM-23
			GM-23P	GM-23P
GM (CADILLAC)	ALLANTE	1987-1988	GM-16P	
	BROUGHAM	1996-1997		GM-12
	C.DE VILLE	1991-		GM-12P
	ELDORADO-TC	1991-		GM-H
	FLEETWOOD	1991-		GM-HP
	SEVILLE	1991-		
	ELDORADO-TC	1989-1990		GM-11
				GM-11P
				GM-D
				GM-DP
	MODELOS	1935-1966	BAS-11	BAS-11
	MODELOS	1966	GM-6	GM-6
	MODELOS	1967	GM-6P	GM-6P
	MODELOS	1971	GM-A	GM-A
	MODELOS	1975	GM-AP	GM-AP
	MODELOS	1986		
	MODELOS	1968	GM-7	GM-7
	MODELOS	1972	GM-7P	GM-7P
			GM-C	GM-C
			GM-CP	GM-CP
	MODELOS	1969	GM-8	GM-8
	MODELOS	1973	GM-8P	GM-8P
			GM-E	GM-E
			GM-EP	GM-EP
	MODELOS	1970	GM-9	GM-9
MODELOS	1974	GM-9P	GM-9P	
MODELOS	1978	GM-J	GM-J	
		GM-JP	GM-JP	
MODELOS	1976	GM-7	GM-11	
		GM-7P	GM-11P	
		GM-C	GM-7	
		GM-CP	GM-7P	
			GM-C	
			GM-CP	
			GM-D	
			GM-DP	
MODELOS	1977	GM-8	GM-12	
		GM-8P	GM-12P	
		GM-E	GM-8	
		GM-EP	GM-8P	
			GM-E	
			GM-EP	
			GM-H	
			GM-HP	
MODELOS	1979	GM-6	GM-10	
		GM-6P	GM-10P	
		GM-A	GM-6	
		GM-AP	GM-6P	
			GM-A	
			GM-AP	
			GM-B	



MARCA BRAND	MODELO MODEL				
GM (CADILLAC)				GM-BP	
	MODELOS	1980	GM-7 GM-7P GM-C GM-CP	GM-11 GM-11P GM-D GM-DP	
	MODELOS	1981	GM-8 GM-8P GM-E GM-EP	GM-12 GM-12P GM-H GM-HP	
	MODELOS	1982	GM-9 GM-9P GM-J GM-JP	GM-13 GM-13P GM-K GM-KP	
	MODELOS	1983	GM-6 GM-6P GM-A GM-AP	GM-10 GM-10P GM-B GM-BP	
	MODELOS	1984	GM-6	GM-10	
	MODELOS	1985	GM-6P GM-7 GM-7P GM-A GM-AP GM-C GM-CP	GM-10P GM-7 GM-7P GM-B GM-BP GM-C GM-CP	
	GM (CHEVROLET BRA.)	CHEVAIR	-	OP-WHP	OP-WHP
		CHEVROLET	1982-1987	OP-WYP	OP-WYP
		COMMODORE	-		
		MONZA	1982-1987		
		OMEGA	-		
		CHEVETTE	1987-1989	OP-R	OP-R
		CHEVROLET	1987-	OP-RP OP-T OP-TP	OP-RP OP-T OP-TP
		CHEVROLET	1989-1990	OP-D	OP-D
PANEMA		1989-	OP-DP OP-S OP-SP	OP-DP OP-S OP-SP	
CHEVROLET		1990-	SUZU-7	SUZU-7	
SPRINT 1.0		-	SUZU-7P	SUZU-7P	
DIPLOMATA		-	CHR-8 CHR-8P	CHR-8 CHR-8P	
MODELOS		1935-1966	BAS-11	BAS-11	
MODELOS		1966	GM-6	GM-6	
MODELOS		1967	GM-6P	GM-6P	
MODELOS		1971	GM-A	GM-A	
MODELOS		1975	GM-AP	GM-AP	
MODELOS		1986			
MODELOS		1968	GM-7	GM-7	
MODELOS		1972	GM-7P GM-C GM-CP	GM-7P GM-C GM-CP	
MODELOS	1969	GM-8	GM-8		
MODELOS	1973	GM-8P	GM-8P		



MARCA BRAND	MODELO MODEL			
GM (CHEVROLET BRA.)			GM-E GM-EP	GM-E GM-EP
	MODELOS	1970	GM-9	GM-9
	MODELOS	1974	GM-9P	GM-9P
	MODELOS	1978	GM-J GM-JP	GM-J GM-JP
	MODELOS	1976	GM-7 GM-7P GM-C GM-CP	GM-11 GM-11P GM-7 GM-7P GM-C GM-CP
	MODELOS	1977	GM-8 GM-8P GM-E GM-EP	GM-12 GM-12P GM-8 GM-8P GM-E GM-EP GM-H GM-HP
	MODELOS	1979	GM-6 GM-6P GM-A GM-AP	GM-10 GM-10P GM-6 GM-6P GM-A GM-AP GM-B GM-BP
	MODELOS	1980	GM-7 GM-7P GM-C GM-CP	GM-11 GM-11P GM-D GM-DP
	MODELOS	1981	GM-8 GM-8P GM-E GM-EP	GM-12 GM-12P GM-H GM-HP
	MODELOS	1982	GM-9 GM-9P GM-J GM-JP	GM-13 GM-13P GM-K GM-KP
	MODELOS	1983	GM-6 GM-6P GM-A GM-AP	GM-10 GM-10P GM-B GM-BP
	MODELOS	1984	GM-6	GM-10
	MODELOS	1985	GM-6P GM-7 GM-7P GM-A GM-AP GM-C GM-CP	GM-10P GM-7 GM-7P GM-B GM-BP GM-C GM-CP



AUTOMÓVIL - CAMIONETA

CAR - PICK-UP TRUCKS

MARCA BRAND	MODELO MODEL			
GM (CHEVROLET)	ASTRO VAN	1996-1997	GM-14	GM-14
	CAVALIER	1996-1997	GM-14P	GM-14P
	LARGE BLAZER	1996-1997	GM-25	GM-25
	LARGE PICKUP	1996-1997	GM-25P	GM-25P
	MODELOS	1995		
	S-10 BLAZER	1996-1997		
	S-10 PICKUP	1996-1997		
	VENTURE	1997		
	BERETTA	1987-1990	GM-17P	GM-11
	CORSICA	1987-1990		GM-11P
				GM-D
				GM-DP
	BERETTA	1991-	GM-18P	GM-12
	CORSICA	1991-		GM-12P
				GM-H
				GM-HP
	CAMARO	1989-1990		GM-11
	CORVETTE	1989-1990		GM-11P
				GM-D
				GM-DP
	CAMARO	1991-		GM-12
	CAVALIER RS	1991-		GM-12P
	CORVETTE	1991-		GM-H
				GM-HP
	CAVALIER LS	1991-1992	GM-22	
			GM-22P	
	CAVALIER LS	1993-	GM-23	
			GM-23P	
	COLORADO	2004	TOYO-15	TOYO-15
			TOYO-15P	TOYO-15P
	IMPALA	2000-2005	GM-14	GM-14
			GM-14P	GM-14P
KODIAK 6	1997	GM-8	GM-12	
MODELOS	1981	GM-8P	GM-12P	
WHEELER	1997	GM-E	GM-H	
		GM-EP	GM-HP	
LUMINA	1988-1990	GM-19P	GM-11	
			GM-11P	
			GM-D	
			GM-DP	
LUMINA	1991-	GM-20P	GM-12	
			GM-12P	
			GM-H	
			GM-HP	
MODELOS	1935-1966	BAS-11	BAS-11	
MODELOS	1966	GM-6	GM-6	
MODELOS	1967	GM-6P	GM-6P	
MODELOS	1971	GM-A	GM-A	
MODELOS	1975	GM-AP	GM-AP	
MODELOS	1986			
MODELOS	1968	GM-7	GM-7	
MODELOS	1972	GM-7P	GM-7P	
		GM-C	GM-C	
		GM-CP	GM-CP	



MARCA BRAND	MODELO MODEL			
GM (CHEVROLET)	MODELOS	1969	GM-8	GM-8
	MODELOS	1973	GM-8P	GM-8P
			GM-E	GM-E
			GM-EP	GM-EP
	MODELOS	1970	GM-9	GM-9
	MODELOS	1974	GM-9P	GM-9P
	MODELOS	1978	GM-J	GM-J
			GM-JP	GM-JP
	MODELOS	1976	GM-7	GM-11
			GM-7P	GM-11P
			GM-C	GM-7
			GM-CP	GM-7P
				GM-C
				GM-CP
				GM-D
				GM-DP
	MODELOS	1977	GM-8	GM-12
			GM-8P	GM-12P
			GM-E	GM-8
			GM-EP	GM-8P
				GM-E
				GM-EP
				GM-H
				GM-HP
	MODELOS	1979	GM-6	GM-10
			GM-6P	GM-10P
			GM-A	GM-6
			GM-AP	GM-6P
				GM-A
				GM-AP
				GM-B
				GM-BP
MODELOS	1980	GM-7	GM-11	
		GM-7P	GM-11P	
		GM-C	GM-D	
		GM-CP	GM-DP	
MODELOS	1982	GM-9	GM-13	
		GM-9P	GM-13P	
		GM-J	GM-K	
		GM-JP	GM-KP	
MODELOS	1983	GM-6	GM-10	
		GM-6P	GM-10P	
		GM-A	GM-B	
		GM-AP	GM-BP	
MODELOS	1984	GM-6	GM-10	
MODELOS	1985	GM-6P	GM-10P	
		GM-7	GM-7	
		GM-7P	GM-7P	
		GM-A	GM-B	
		GM-AP	GM-BP	
		GM-C	GM-C	
		GM-CP	GM-CP	
SPARK	-	DAE-3P2	DAE-3P2	
SPECTRUM	1985-1989	GM-2	GM-2	



MARCA BRAND	MODELO MODEL			
GM (CHEVROLET)	SPRINT	1985-1988	GM-2P	GM-2P
			GM-1P	GM-1P
GM (GEO)	METRO	1989-	GM-5	GM-5
	STROM	1990-	GM-5P	GM-5P
	PRIZM	1993-1994	GM-24	GM-24
			GM-24P	GM-24P
	SPECTRUM	1985-	GM-2	GM-2
STROM	1989-1990	GM-2P	GM-2P	
GM (GMC)	MODELOS	1935-1966	BAS-1I	BAS-1I
	MODELOS	1966	GM-6	GM-6
	MODELOS	1967	GM-6P	GM-6P
	MODELOS	1971	GM-A	GM-A
	MODELOS	1975	GM-AP	GM-AP
	MODELOS	1986		
	MODELOS	1968	GM-7	GM-7
	MODELOS	1972	GM-7P	GM-7P
			GM-C	GM-C
			GM-CP	GM-CP
	MODELOS	1969	GM-8	GM-8
	MODELOS	1973	GM-8P	GM-8P
			GM-E	GM-E
			GM-EP	GM-EP
	MODELOS	1970	GM-9	GM-9
	MODELOS	1974	GM-9P	GM-9P
			GM-J	GM-J
	MODELOS	1978	GM-JP	GM-JP
	MODELOS	1976	GM-7	GM-11
			GM-7P	GM-11P
			GM-C	GM-7
			GM-CP	GM-7P
				GM-C
				GM-CP
	MODELOS	1977	GM-8	GM-12
			GM-8P	GM-12P
GM-E			GM-8	
GM-EP			GM-8P	
			GM-E	
MODELOS	1979	GM-6	GM-10	
		GM-6P	GM-10P	
		GM-A	GM-6	
		GM-AP	GM-6P	
			GM-A	
MODELOS	1980	GM-AP	GM-AP	
		GM-B	GM-B	
		GM-BP	GM-BP	
		GM-7	GM-11	
		SIERRA GLE	1991-	GM-7P
		GM-C	GM-D	



MARCA BRAND	MODELO MODEL			
GM (GMC)	MODELOS	1981	GM-CP	GM-DP
			GM-8	GM-12
			GM-8P	GM-12P
	MODELOS	1982	GM-E	GM-H
			GM-EP	GM-HP
			GM-9	GM-13
	MODELOS	1983	GM-9P	GM-13P
			GM-J	GM-K
			GM-JP	GM-KP
	MODELOS	1984	GM-6	GM-10
			GM-6P	GM-10P
			GM-A	GM-B
	MODELOS	1985	GM-AP	GM-BP
			GM-6	GM-10
			GM-6P	GM-10P
MODELOS	1986	GM-7	GM-7	
		GM-7P	GM-7P	
		GM-A	GM-B	
MODELOS	1987	GM-AP	GM-BP	
		GM-C	GM-C	
		GM-CP	GM-CP	
GM (OLDS MOBILE)	98 REGENCY	1991-		GM-12
	DELTA 88 RO.	1992-		GM-12P
	TORONADO	1991-		GM-H
				GM-HP
	ACHIEVA	1992-1993	GM-22	
			GM-22P	
			GM-23	
				GM-23P
	ACHIEVA	1994	GM-14	GM-14
	AURORA	1995	GM-14P	GM-14P
			GM-25	GM-25
			GM-25P	GM-25P
	ALERO	00-04	GM-14	GM-14
	INTRIGUE	00-03	GM-14P	GM-14P
	CUTLASS	1988-1990	GM-19P	
SILHOUETTE	1988-1990			
CUTLASS SUP.	1991-	GM-20P		
MODELOS	1935-1966	BAS-1I	BAS-1I	
MODELOS	1966	GM-6	GM-6	
MODELOS	1967	GM-6P	GM-6P	
MODELOS	1971	GM-A	GM-A	
MODELOS	1975	GM-AP	GM-AP	
MODELOS	1986			
MODELOS	1988	GM-7	GM-7	
MODELOS	1972	GM-7P	GM-7P	
		GM-C	GM-C	
		GM-CP	GM-CP	
MODELOS	1969	GM-8	GM-8	
MODELOS	1973	GM-8P	GM-8P	
		GM-E	GM-E	
		GM-EP	GM-EP	
MODELOS	1970	GM-9	GM-9	



AUTOMÓVIL - CAMIONETA

CAR - PICK-UP TRUCKS

MARCA BRAND	MODELO MODEL			
GM (OLDS MOBILE)	MODELOS	1974	GM-9P	GM-9P
	MODELOS	1978	GM-J	GM-J
			GM-JP	GM-JP
	MODELOS	1976	GM-7	GM-11
			GM-7P	GM-11P
			GM-C	GM-7
			GM-CP	GM-7P
				GM-C
				GM-CP
				GM-D
				GM-DP
	MODELOS	1977	GM-8	GM-12
			GM-8P	GM-12P
			GM-E	GM-8
			GM-EP	GM-8P
				GM-E
				GM-EP
				GM-H
				GM-HP
	MODELOS	1979	GM-6	GM-10
			GM-6P	GM-10P
			GM-A	GM-6
			GM-AP	GM-6P
				GM-A
				GM-AP
				GM-B
				GM-BP
	MODELOS	1980	GM-7	GM-11
			GM-7P	GM-11P
			GM-C	GM-D
			GM-CP	GM-DP
	MODELOS	1981	GM-8	GM-12
			GM-8P	GM-12P
			GM-E	GM-H
			GM-EP	GM-HP
	MODELOS	1982	GM-9	GM-13
			GM-9P	GM-13P
			GM-J	GM-K
			GM-JP	GM-KP
	MODELOS	1983	GM-6	GM-10
			GM-6P	GM-10P
			GM-A	GM-B
			GM-AP	GM-BP
	MODELOS	1984	GM-6	GM-10
	MODELOS	1985	GM-6P	GM-10P
			GM-7	GM-7
			GM-7P	GM-7P
		GM-A	GM-B	
		GM-AP	GM-BP	
		GM-C	GM-C	
		GM-CP	GM-CP	
TORONADO	1989-1990		GM-11	
			GM-11P	
			GM-D	
			GM-DP	



MARCA BRAND	MODELO MODEL			
GM (PONTIAC)	BONNEVILLE	1992-		GM-12
	FIREBIRD	1991-		GM-12P
	FORMULA	1991-		GM-H
	GTA	1991-		GM-HP
	TRANS AM	1991-		
	GRAND AM	00-05	GM-14	GM-14
	TORRENT	2000-2005	GM-14P	GM-14P
	GRAND AM	1992-1993	GM-22	
	SUNBIRD	1992-1993	GM-22P	
			GM-23	
			GM-23P	
	GRAND AM	1994	GM-14	GM-14
			GM-14P	GM-14P
			GM-25	GM-25
			GM-25P	GM-25P
	GRAND PRIX	1991-1994	GM-20P	
	LE MANS	1987-	OP-S	OP-S
			OP-SP	OP-SP
	MODELOS	1935-1966	BAS-11	BAS-11
	MODELOS	1966	GM-6	GM-6
	MODELOS	1967	GM-6P	GM-6P
	MODELOS	1971	GM-A	GM-A
	MODELOS	1975	GM-AP	GM-AP
	MODELOS	1986		
	MODELOS	1968	GM-7	GM-7
	MODELOS	1972	GM-7P	GM-7P
			GM-C	GM-C
			GM-CP	GM-CP
	MODELOS	1969	GM-8	GM-8
	MODELOS	1973	GM-8P	GM-8P
			GM-E	GM-E
			GM-EP	GM-EP
	MODELOS	1970	GM-9	GM-9
	MODELOS	1974	GM-9P	GM-9P
MODELOS	1978	GM-J	GM-J	
		GM-JP	GM-JP	
MODELOS	1976	GM-7	GM-11	
		GM-7P	GM-11P	
		GM-C	GM-7	
		GM-CP	GM-7P	
			GM-C	
			GM-CP	
			GM-D	
			GM-DP	
MODELOS	1977	GM-8	GM-12	
		GM-8P	GM-12P	
		GM-E	GM-8	
		GM-EP	GM-8P	
			GM-E	
			GM-EP	
			GM-H	
			GM-HP	
MODELOS	1979	GM-6	GM-10	



MARCA BRAND	MODELO MODEL			
GM (PONTIAC)			GM-6P	GM-10P
			GM-A	GM-6
			GM-AP	GM-6P
				GM-A
				GM-AP
				GM-B
				GM-BP
	MODELOS	1980	GM-7	GM-11
			GM-7P	GM-11P
			GM-C	GM-D
			GM-CP	GM-DP
	MODELOS	1981	GM-8	GM-12
			GM-8P	GM-12P
			GM-E	GM-H
			GM-EP	GM-HP
	MODELOS	1982	GM-9	GM-13
			GM-9P	GM-13P
			GM-J	GM-K
			GM-JP	GM-KP
	MODELOS	1983	GM-6	GM-10
		GM-6P	GM-10P	
		GM-A	GM-B	
		GM-AP	GM-BP	
MODELOS	1984	GM-6	GM-10	
MODELOS	1985	GM-6P	GM-10P	
		GM-7	GM-7	
		GM-7P	GM-7P	
		GM-A	GM-B	
		GM-AP	GM-BP	
		GM-C	GM-C	
		GM-CP	GM-CP	
SUNFIRE	00-05	GM-25	GM-25	
		GM-25P	GM-25P	
TRANS SPORT	1988-1990	GM-19P		
GM (SATURN)	SATURN	1990-1994	GM-21	GM-21
			GM-21P	GM-21P
HAMOMAG HENSCHEL	F 20	-	ME-VA	ME-VA
	F 35	-		
HOLDEN	APOLLO	1991-	TOYO-14	TOYO-14
	NOVA	1991-	TOYO-14P	TOYO-14P
	ASTRA	1986	DAT-12	DAT-12
	BARINA	1981-1990	MIT-11	MIT-11
	CAMIRA	1980-	MIT-11P	MIT-11P
	DROVER	1981-	TOYO-14	TOYO-14
	GEMINI	1980-1984	TOYO-14P	TOYO-14P
	JACKAROO	1980-		
	RODEO	1980-		
	SHUTTLE	1980-		
	BARINA	1991-1993	SUZU-10	SUZU-10
			SUZU-10P	SUZU-10P
	BARINA	1994	OP-S	OP-S
			OP-SP	OP-SP
	BELMOND	1971-1978	GM-6	GM-6



MARCA BRAND	MODELO MODEL			
HOLDEN	KINGSWOOD	1971-1978	GM-6P	GM-6P
	STATESMAN	1972-1978	GM-A	GM-A
	TORANA	1971-1972	GM-AP	GM-AP
	BELMOND	-1979	GM-42	GM-42
	CALAIS	1978-		
	COMMODORE	1978-		
	KINGSWOOD	1979-		
	STATESMAN	1978-		
	CALAIS	1993-	OP-WHP	OP-WHP
	COMMODORE	1993-		
	COMMODORE	1987-1993	OP-WHP	OP-WHP
			OP-WYP	OP-WYP
	FJ	-	HUD-1	HUD-1
	GEMINI	1985-	GM-2	GM-2
	SPECTRUM	1985-	GM-2P	GM-2P
	GEMINI STAT.	1981-	MIT-11	OP-AB
			MIT-11P	OP-ABP
			TOYO-14	OP-BA
			TOYO-14P	OP-BAP
				OP-J
			OP-JP	
MODELOS	1955-1970	BAS-11	BAS-11	
TORANA	-1971	BAS-11	UN-FS	
HONDA	ACCORD	1976-1980	HOND-1	HOND-1
	CIVIC	1973-1976	HOND-1P	HOND-1P
			HOND-2	HOND-2
			HOND-2P	HOND-2P
	ACCORD	1981-1982	HOND-10	HOND-10
	ACCORD	1984-1990	HOND-10P	HOND-10P
	CITY JAZZ	1981-1985		
	CIVIC	1984-1987		
	PRELUDE	1983-1988		
	PRELUDE	1989-1991		
	QUINTET	1981-1983		
	ACCORD	1982-1983	HOND-10	HOND-10
	CIVIC	1977-1981	HOND-10P	HOND-10P
			HOND-11	HOND-11
			HOND-11P	HOND-11P
	ACCORD	1990-1992	HOND-14	HOND-14
			HOND-14P	HOND-14P
			HOND-15	HOND-15
			HOND-15P	HOND-15P
			HOND-16D	HOND-16D
			HOND-16DP	HOND-16DP
	ACCORD 2 LS	1993-1995	NE-35	NE-35
	ACCORD 2 S	1993-1995	NE-35P2	NE-35P2
	CIVIC	1995		
	CONCERTO	1989-		
	ACCORD COUPE	1993-1995	HOND-14	HOND-14
	CIVIC	1988-1995	HOND-14P	HOND-14P
	ACCORD EX	1991-1995	HOND-16D	HOND-16D
			HOND-16DP	HOND-16DP
	CIVIC	1972-1973	NE-1	HOND-3D



AUTOMÓVIL - CAMIONETA

CAR - PICK-UP TRUCKS

MARCA BRAND	MODELO MODEL			
HONDA			NE-1P	
	CIVIC	1982-1983	HOND-12	HOND-12
	PRELUDE	1982	HOND-12P	HOND-12P
			HOND-13	HOND-13
			HOND-13P	HOND-13P
	CIVIC CRX	1989-1992	HOND-14	HOND-14
	CIVIC SHUTLE	1989-1992	HOND-14P	HOND-14P
			HOND-15	HOND-15
			HOND-15P	HOND-15P
	COUPE	1969-1975	NE-1	
	LIFE	1969-1975	NE-1P	
	N 360	1969-1975		
	TOURER	1969-1975		
	PRELUDE	1992-1997	HOND-14	HOND-14
			HOND-14P	HOND-14P
		HOND-16D	HOND-16D	
		HOND-16DP	HOND-16DP	
HUMMER	H2	2005-		
	H3	2005-		
HYUNDAI	ACCENT	1994-1996	HY-5	HY-5
	EXCEL	1994-1995	HY-5P	HY-5P
	ELANTRA	1991-1996	HY-4	HY-4
	LANTRA	1991-1996	HY-4P	HY-4P
	TIBURON	2001	HY-4P2	HY-4P2
			HY-4P3	HY-4P3
	EXCEL	1986-1989	HY-3D	HY-3D
			HY-3DP	HY-3DP
	EXCEL	1990-1991	HY-3D	HY-3D
	PONY	1991-	HY-3DP1	HY-3DP1
	S COUPE	1991-1996		
	SONATA	1991-1996		
	PONY	1974-1979	HY-1	HY-1
	PONY	1980-1984	TOYO-14	TOYO-14
			TOYO-14P	TOYO-14P
	PONY (CAN)	1985-1987	MIT-2I	MIT-2I
			MIT-2IP	MIT-2IP
	PONY (EU)	1985-1987	HY-2	HY-2
	STELLAR	1985-1987	HY-2P	HY-2P
			HY-7P	HY-7P
	SONATA	1989-1990	HY-3	HY-3
			HY-3P2	HY-3P2
	SONATA (USA)	1993-1995	HY-6D	HY-6D
SONICA	1993-1995	HY-6DP	HY-6DP	
STAREX	1998-	HY-9P2	HY-9P2	
VAN TRANSP.	1994-1997	HY-8	HY-8	
		HY-8P	HY-8P	
INFINITI (NIS-SAN)	G 20	1992-	DAT-10	DAT-10
	M 30	1992-	DAT-10P	DAT-10P
			DAT-7	DAT-7
			DAT-7P	DAT-7P
			DAT-7P1	DAT-7P1
	M 30	1990-1991	DAT-13	DAT-13
			DAT-13P	DAT-13P



MARCA BRAND	MODELO MODEL			
INFINITI (NIS-SAN)			DAT-14	DAT-14
			DAT-14P	DAT-14P
INNOCENTI	3 CILINDROS	1982		AF-10
	MINI 650	1985		AF-11
	MINI DIESEL	1984		AF-12
	MINI MILLE	1980		
	MINI TRE	1984		
	MINI TURBO	1983		
	500	1986-	FI-6I	FI-6I
	650	1986-	FI-6IP	FI-6IP
	990	1986-		
	SMALL 500	1986-		
	SMALL 990	1986-		
	A40	-	UN-FP	UN-FP
	ELBA	1992-	FI-11	FI-11
			FI-11P	FI-11P
	J 4	-	LF-BL	UN-FS
	J 5	-	UN-FS	
	JM 3	-		
	MINI 850	-		
	MINI 1000	1973		
	MINI 1001	1973		
	MINI COOPER	1973		
	KORAL 45	1990-1992	FI-6I	FI-3D
	KORAL 55	1990-1992	FI-6IP	FI-3DP
			FI-3DP5	
M.COOPER OR.	-	STR-2	STR-2	
M.MK II 850	-	UN-FS	UN-FS	
M.DE TOMASO	1976	AF-7I	AF-10	
MINI 90	1974	AF-7IP	AF-11	
MINI 120	1974		AF-12	
M.METALLICA	-	LF-RO	UN-FS	
M.T.CLUBMAN	-	LF-ROP		
MINI MATIC	1970-	LF-BL	AF-10	
		UN-FS	AF-11	
			AF-12	
			UN-FS	
REGENT	-	LF-BL	UN-FT	
INTER. HARVESTER	T.TERRENO	-	GM-6	GM-10
			GM-6P	GM-10P
			GM-A	GM-B
			GM-AP	GM-BP
IRMSCHER	VARIOS	1940-1975	KEN-1	KEN-1
	4.0 I	-1981	GM-9	OP-R
			GM-9P	OP-RP
			GM-J	OP-T
			GM-JP	OP-TP
	4.0 I	1981-1986	OP-R	OP-R
			OP-RP	OP-RP
			OP-T	OP-T
			OP-TP	OP-TP
	4.0 I	1986-	OP-WHP	OP-WHP
C.40 E	-	OP-WYP	OP-WYP	



MARCA BRAND	MODELO MODEL			
ISUZU	AMIGO	1988-1991	GM-4	GM-4
	TF	1988-1991	GM-4P	GM-4P
			GM-4P1	GM-4P1
	AMIGO	1991-1994	GM-15D	GM-15D
	RODEO	1991-1994	GM-15DP	GM-15DP
	D-MAX	2002-2006	ISU-3D	ISU-3D
	I-290	2007	ISU-3DP	ISU-3DP
	I-370	2007		
	I MARK	1985-1991	GM-2	GM-2
			GM-2P	GM-2P
	IMPULSE	1985-1991	MIT-2I	MIT-2I
	PIAZZA	1985-1991	MIT-2IP	MIT-2IP
	TROOPER	1985-1991		
	IMPULSE	1992-	GM-5	GM-5
	STYLUS	1992-	GM-5P	GM-5P
	MODELOS	1981-1984	MIT-1I	MIT-1I
			MIT-1IP	MIT-1IP
TROOPER	1982-1984	TOYO-14	TOYO-14	
		TOYO-14P	TOYO-14P	
TROOPER	1991-	GM-1P	GM-1P	
VEHY-CROSS	1998-2002	SUZU-10P	SUZU-10P	
JAGUAR	E	1970-1974	FO-D	UN-1FS
			FO-FR	UN-FS
			FO-FRP	
			WAS-2P	
	MAJESTIC	1989-1994	JAU-1P	JAU-1P
	SOVEREIGN	1989-1994		
	VANDEN PLAS	1989-1994		
	XJ 6	1989-1994		
	XJS	1988-		
	VANDEN PLAS	1988-1989		
	XJ 6-40	1988-1989		
	XJ 6	1971-1975	FO-D	IN-4
			FO-FR	UN-1FS
			FO-FRP	UN-FS
			WAS-2P	UN-FT
	XJ 6	1976-1978	FO-FR	FO-5
			FO-FRP	
			WAS-2P	
	XJ 6-12	1979-1987	FO-FR	CEM-JC
FO-FRP				
WAS-2P				
XJS	1975	FO-FR	UN-FT	
		FO-FRP		
		WAS-2P		
XJS	1976	FO-FR	LF-WR	
XJS	1978-1987	FO-FRP		
		WAS-2P		
XJS	1976-1977	LF-WR	FO-TC	
JDM	ABACA	2005-2012	SIX-3P	SIX-3P
	ALBIZIA	2003-2012		
	ALOES	2008-2012		
	ROSDY	2012		



MARCA BRAND	MODELO MODEL			
JEEP	BRIAR WOOD	1991-1992	CHR-9	CHR-9
	CHEROKEE	1991-1992	CHR-9P	CHR-9P
	COMANCHE	1991-1992		
	LAREDO	1991-1992		
	LTD	1991-1992		
	WRANGLER	1991-1992		
	CHEROKEE	1993-1998	CHR-10	CHR-10
	COMANCHE	1993-	CHR-10P	CHR-10P
	COUNTRY	1993-		
	G.CHEROKEE	1993-1998		
	G.WAGONEER	1993-		
	LAREDO	1993-		
	LTD	1993-		
	RENEGADE	1993-		
	SAHARA	1993-		
	SPURR	1993-		
	WAGONEER	1993-		
	WRANGLER	1993-		
	COMANCHE	1985-1990	GM-9	
	PIONNER	-1991	GM-9P	
	SCRAMBLER	1985-1990	GM-J	
	WAGONEERS	1985-1990	GM-JP	
	WRANGLER	1985-1990		
	COMMANDO D	-	FEM-3I	CL-4I
	RENEGADE	1979-1984	GM-9	YA-11D
			GM-9P	
			GM-J	
		GM-JP		
VARIOS	1940-1973	KEN-1	KEN-1	
JENSEN	INTERCEPT. 2	-	FO-FR	UN-FS
	INTERCEPT. 3	-	FO-FRP	
KENWORTH	VARIOS	1950-1987	KEN-1	KEN-1
	VARIOS	1960-1986	HUD-1	HUD-1
KIA	CARNIVAL	1999-	KI-3DP	KI-3DP
	CLARENCE	2001-		
	CLARUS	1998-2001		
	PRIDE	1999-		
	RIO	2001-		
	SHUMA	1998-2000		
	SORENTO	1998-		
	PRIDE 1.1 L	1992-1994	KI-1D	KI-1D
	PRIDE 1.3 LX	1992-1994	KI-1DP	KI-1DP
	SEPHIA (USA)	1994-1995		
	SEPHIA 1.6 I	1993-1994		
SPORTAGE	1995-1996			
SEPHIA (USA)	1994-	KI-1DP1	KI-1DP1	
SPORTAGE USA	1996-	KI-2D	KI-2D	
LA FORZA	FORZA 5.0 V8	1989-	GI0B-3P	
LADA VAZ	1200	1972-	NE-3	IMS-3
	1300	1972-	NE-3P	IMS-3P
	1500	1972-	NE-3P1	IMS-5
	1600	1972-	NE-3P2	IMS-5P
	2101	1972-		



AUTOMÓVIL - CAMIONETA

CAR - PICK-UP TRUCKS

MARCA BRAND	MODELO MODEL			
LADA VAZ	2102	1972-		
	2103	1972-		
	2104	1972-		
	2105	1972-		
	2106	1972-		
	2107	1972-		
	21011	1972-		
	21043	1972-		
	21061	1972-		
	NIVA	-		
	RIVA	-		
	3110	-	LA-3D	LA-2
			LA-3DP	LA-2P
			LA-4D	
			LA-4DP	
	4x4	-	LA-1D	LA-1D
	4x4 G.LARGE	-	LA-1DP	LA-1DP
	KAMA	1984-	LA-2	LA-2
	SAGONA	-	LA-2P	LA-2P
			LA-3D	LA-3D
		LA-3DP	LA-3DP	
CARLOTA	1991-	LA-1D	LA-1D	
SAMARA	1991-1992	LA-1DP	LA-1DP	
NIVA 1.6	1992-	NE-3	IMS-3	
		NE-3P	IMS-3P	
		NE-3P1		
		NE-3P2		
SAMARA	1992-	LA-3D	LA-2	
		LA-3DP	LA-2P	
LAMBORGHINI	COUNTACH	-	AF-7I	IMS-3
	DIABLO COU.	-	AF-7IP	IMS-3P
	DIABLO ROA.	-	AF-7IP1	IMS-5
	JALPA	-		IMS-5P
	URRACO	-		
	ESPADA	-	AF-7I	AF-5I
			AF-7IP	AF-6I
			AF-7IP1	
	MIURA	-	BH-1	AF-4D
			BH-1P	AF-4I
			AF-5D	
			AF-5I	
			AF-6D	
			AF-6I	
LANCIA	2000	-1972	GIOB-1D	GIOB-2I
	APPIA	-1972	GIOB-1DP	GIOB-2IP
	FLAVIA	-1972		
	FULVIA	-1972		
	2000	1972-	GIOB-1D	GIOB-2I
	FULVIA	1972-	GIOB-1DP	GIOB-2IP
			SIP-3	
	BETA	1972-1982	AF-7I	GIOB-3P
	DELTA	1979-1982	AF-7IP	
	GAMMA	1972-1982	FI-9I	



MARCA BRAND	MODELO MODEL			
LANCIA			FI-9IP	
	BETA	1975-1980	AF-7I	AF-10
	MONTECARLO	1975-1980	AF-7IP	AF-11
				AF-12
	DEDRA	1989-1995	FI-13	FI-13
	DEDRA S.W.	1994	FI-13P	FI-13P
	DELTA	1993-1995	FI-14P	FI-14P
	DELTA	1983	FI-3D	GIOB-3P
			FI-3DP	
			FI-3DP3	
			FI-6I	
			FI-6IP	
			FI-6IP3	
	DELTA	1984-1992	FI-11	GIOB-3P
	PRISMA	1984-1989	FI-11P	
	LANCIA Z	1994	SIX-3P1	SIX-3P1
	Z 2000	1994		
	MODELOS	2000		FI-16P1
	THEMA	1984-	FI-10	FI-10
			FI-10P	FI-10P
		FI-11	FI-11	
		FI-11P	FI-11P	
TREVI	1980-	FI-9I	GIOB-3P	
		FI-9IP		
LAND-RANGE ROVER	88	1982-1983	LF-RO	UN-FS
	88	1984	LF-ROP	
	109	1982-1983		
	109	1984		
	110	1984-1985		
	88	1985-1987	LF-RO	AB-6I
	109	1985-1987	LF-ROP	
	110	1986-1987		
	SANTANA	1985-1987		
	90	1985-1986	LF-RO	LF-RO
	110	1985-1986	LF-ROP	LF-ROP
	90	1987-1991	LF-RO	UN-FT
	110	1987-1991	LF-ROP	
	DEFENDER	1990-		
	90 2500	1988-1991	IMS-7	AB-6I
	90 3500	1988-1991	IMS-7P	
	110 2500	1985-1987		
	110 3500	1985-1987		
	SANTANA	1987-1991		
	DISCOVERY	1989-1993	NE-11	NE-11
		NE-11P1	NE-11P1	
		NE-11P2	NE-11P2	
DISCOVERY	1994-1997	NE-52P	NE-52P	
MODELOS	1970-1972	UN-FS	UN-FP	
MODELOS	1973-1981	UN-FS	UN-FS	
R.ROVER	-1983	UN-NH	UN-NH	
		UN-NHP	UN-NHP	
R.ROVER	1984-1988	NE-11	NE-11	
		NE-11P	NE-11P	



MARCA BRAND	MODELO MODEL			
LAND-RANGE ROVER			NE-11P	NE-11P
			NE-11P1	NE-11P1
			NE-11P2	NE-11P2
			NE-24	NE-24
			NE-24P	NE-24P
			NE-24P1	NE-24P1
	R.ROVER	1989-1997	NE-11	NE-11
			NE-11P	NE-11P
LEXUS (TOYOTA)	250 ES	1989-	TOYO-18P	TOYO-18P
	300 ES	1989-		
	400 LS	1989-		
	COUPE 300 SC	1991-		
	COUPE 400 SC	1991-		
LIGIER	IXO	2010	SIX-3P	SIX-3P
	JS	-		
	NOVA	1999-2004		
	OPTIMAX	2010		
	X-T00	2006-2012		
LOTUS	ECLAT	-	TOYO-K1	TOYO-K1
	EXCEL SE	-	TOYO-K1P	TOYO-K1P
	ELAN SE	1991	OP-D	OP-D
			OP-DP	OP-DP
	ESPRIT 2.2	-	LF-RO	UN-FT
	ESPRIT COUPE	1991-	LF-ROP	
	ESPRIT TURBO	-		
	MODELOS	-1976	FO-FR	UN-FS
			FO-FRP	UN-FT
			LF-RO	
LF-ROP				
MACK	VARIOS	1955-1969	KEN-1	KEN-1
	VARIOS	1970-1986	HUD-1	HUD-1
MARUTI	800	1991-1992	SUZU-7	SUZU-7
	800 LUXE	1991-1992	SUZU-7P	SUZU-7P
	800 S.LUXE	1991-1992		
MASERATI	BITURBO	1981-	LF-RO	AF-10
	GHIBLI	1986-	LF-ROP	AF-11
	KARIF	1986-		AF-12
	QUATTROPORTE	1976-1986		
	SHAMAL	1986-		
	SPYDER	1986-		
	BORA	1971-1976	AF-7I	RO-5D
			AF-7IP	
			AF-7IP1	
	GHIBLI 5000	-		IMS-3
				IMS-3P
	INDY 4900 A.	1969-	AF-7I	GIOB-2I
			AF-7IP	GIOB-2IP
			AF-7IP1	RO-5D
KHAM SIN	1972-	AF-7I	IMS-3	
		AF-7IP	IMS-3P	
		AF-7IP1	IMS-5	



MARCA BRAND	MODELO MODEL			
MASERATI				IMS-5P
	KYALAMI	1976-	FO-2	IMS-5
				IMS-5P
	MERAK	1972-1976	CT-3	RO-5D
			CT-3P	
MAZDA	121	1988-1990	MAZ-3D	MAZ-3D
	323	1983-1989	MAZ-6DP	MAZ-6DP
	323 S.W.	1986-1996		
	626	1987-1991		
	626 S.W.	1986-1992		
	727	1987-1991		
	929 S.W.	1982-		
	COSMO	1984-1986		
	MX6	1986-1989		
	RX7	1987-1991		
	121	1991-1992	MAZ-5D	MAZ-5D
			MAZ-5DP	MAZ-5DP
			MAZ-7D	MAZ-7D
			MAZ-7DP	MAZ-7DP
	121	1993-1994	MAZ-13D	MAZ-13D
			MAZ-13DP	MAZ-13DP
	323	1992-1994	MAZ-13DP1	MAZ-13DP1
			MAZ-7D	MAZ-7D
	MX3	1992-1995	MAZ-7D	MAZ-7D
			MAZ-7DP	MAZ-7DP
	RX7	1992-	MAZ-7DP	MAZ-7DP
	XEDOS	1992-1996		
121	1995-	FO-6P	FO-6P	
323	1977-1982	MAZ-2D	MAZ-2D	
		MAZ-2DP	MAZ-2DP	
323 S.W.	1977-1986			
626	1978-1982			
929	1980-1982			
929 S.W.	1980-1982			
323	1982-1983	MAZ-3D	MAZ-3D	
		MAZ-3DP	MAZ-3DP	
		MAZ-3I	MAZ-3I	
		MAZ-3IP	MAZ-3IP	
323	1989-1992	MAZ-3D	MAZ-3D	
		MAZ-7D	MAZ-7D	
		MAZ-7DP	MAZ-7DP	
323	1995		MAZ-7DP1	
MX3	1995			
MX5	1995			
323 B.F.	1982	NE-23	MAZ-2D	
		NE-26	MAZ-2DP	
			MAZ-2I	
			MAZ-2IP	
323 S.P.	1990	MAZ-7D	MAZ-7D	
MPV	1989-	MAZ-7DP	MAZ-7DP	
MX5 (EU)	1990-1992			
MX6	1990-1992			
616 CAP.	-1970	DAT-3I	MAZ-2D	
616 SNA	-1970		MAZ-2DP	
RX2 CAPPE.	1970-1971			
616 CAPE.	1971-1973	DAT-11D	MAZ-2D	



AUTOMÓVIL - CAMIONETA

CAR - PICK-UP TRUCKS

MARCA BRAND	MODELO MODEL			
MAZDA	618	1971-1973	DAT-11DP	MAZ-2DP
	RX2 CAPPE.	1974-1977	WAS-2P	
	RX3	1974-1977		
	626	1982-1987	MAZ-3D	MAZ-3D
	929	1982-1986	MAZ-3DP	MAZ-3DP
			MAZ-3I	MAZ-3I
			MAZ-6DP	MAZ-6DP
			MAZ-6P	MAZ-6P
	626	1991	MAZ-7D	MAZ-7D
	MX3	1991-1992	MAZ-7DP	MAZ-7DP
			MAZ-7DP1	MAZ-7DP1
	626	1991-1995	MAZ-13D	MAZ-13D
	MX6	1992-1995	MAZ-13DP	MAZ-13DP
			MAZ-13DP1	MAZ-13DP1
	626	1995-1997		MAZ-13D
	MX6	1995-1997		MAZ-13DP
	XEDOS 6	1995-1997		MAZ-13DP1
	626 GL	1981	CHR-3	MAZ-2D
			NE-22P2	MAZ-2DP
	626 S.W.	1993-1996	MAZ-5D	MAZ-5D
	RX7	1991	MAZ-5DP	MAZ-5DP
	808	1971-1977	DAT-11D	MAZ-2D
	818	1971-1977	DAT-11DP	MAZ-2DP
	929	1973-1980	WAS-2P	MAZ-2I
				MAZ-2IP
	818 1.3	-1971	DAT-3I	MAZ-1I
	818 1.5	-1971		
	1800	1971-1972		
	929 GLX	1987-	MAZ-3D	MAZ-3D
	RX7	1983-1986	MAZ-3DP	MAZ-3DP
			MAZ-6DP	MAZ-6DP
	1200	1970-1972	DAT-11D	MAZ-1I
	1800	1970-1971	DAT-11DP	
			WAS-2P	
	1600	1972-	DAT-3I	MAZ-1D
	R 100	1970-1971		
	ARTIS	-	MAZ-21DP1	MAZ-21DP1
	B 1800	1970-1971	MAZ-1I	MAZ-1I
	COSMO	1975-1979	MAZ-16	MAZ-16
	COSMO	1980	MAZ-3D	MAZ-3D
GLC 323	1983-1989	MAZ-3DP	MAZ-3DP	
COSMO	1982-1983	MAZ-3D	MAZ-3D	
		MAZ-3DP	MAZ-3DP	
		MAZ-3I	MAZ-3I	
		MAZ-6P	MAZ-6P	
E 1600	1986	MAZ-2D	MAZ-2D	
		MAZ-2DP	MAZ-2DP	
		MAZ-2I	MAZ-2I	
		MAZ-2IP	MAZ-2IP	
		MAZ-3D	MAZ-3D	
		MAZ-3DP	MAZ-3DP	
		MAZ-3I	MAZ-3I	
		MAZ-3IP	MAZ-3IP	



MARCA BRAND	MODELO MODEL			
MAZDA	EUNOS 800	1993-	TOYO-18P	TOYO-18P
	XEDOS 9	1993-1996		
	MIATA	1989-1992	MAZ-3D	MAZ-3D
	MX5	1989-1992	MAZ-7D	MAZ-7D
			MAZ-7DP	MAZ-7DP
			MAZ-7DP1	MAZ-7DP1
	MODELOS	1970-1974	MAZ-14D	MAZ-14D
	MODELOS	1975-1984	MAZ-1D	MAZ-2D
			MAZ-1I	MAZ-2DP
				MAZ-2I
				MAZ-2IP
	NAVAJO	1991-	MAZ-8D	MAZ-8D
			MAZ-8DP	MAZ-8DP
	R 100	1972-	DAT-11D	MAZ-1D
	R 1200	1972-	DAT-11DP	
			WAS-2P	
	RX2	1972-1973	DAT-11D	MAZ-2I
			DAT-11DP	MAZ-2IP
			WAS-2P	
	RX4 LUCE	1972-1978	MAZ-2D	MAZ-2D
RX5 COSMO	1972-1978	MAZ-2DP	MAZ-2DP	
RX7 COUPE	1972-1978	MAZ-2I	MAZ-2I	
		MAZ-2IP	MAZ-2IP	
MERCEDES	180C	1993-	ME-7P	ME-7P
	200C	1993-	ME-8P	ME-8P
	220C	1993-		
	280C	1993-		
	300C	1993-		
	190	1984-1986	ME-10P	ME-10P
	200	1984-	ME-2P	ME-2P
	230	1984-	ME-3P	ME-3P
	250	1984-	ME-4P	ME-4P
	260	1984-	ME-5P	ME-5P
	280	1979-	ME-6P	ME-6P
	300	1980-		
	360	1984-		
	380	1979-		
	420	1984-		
	450	1979-		
	500	1979-		
	560	1984-		
	1000	1984-		
	190	1986-	ME-4P	ME-4P
			ME-5P	ME-5P
	190 ALARM	1986-1992	ME-10P	ME-10P
			ME-11P	ME-11P
			ME-12P	ME-12P
200	1973-1974	ME-HD	ME-HD	
220	1973-1974	ME-HDP	ME-HDP	
230	1973-1974	ME-HF	ME-HF	
240D	1973-1976	ME-HFP	ME-HFP	
250	1973-1977	ME-HM	ME-HM	
280	1973-1974	ME-HMP	ME-HMP	

MARCA BRAND	MODELO MODEL			
MERCEDES	350	1973-	ME-HZ	ME-HZ
	380	1973-1977	ME-HZP	ME-HZP
	450	1973-1979		
	200	1974-1975	ME-HD	ME-HD
	220	1974-	ME-HDP	ME-HDP
	230	1974-1977	ME-HZ	ME-HZ
	240	1974-1977	ME-HZP	ME-HZP
	280	1974-1979		
	200	1975-1976	ME-HF	ME-HF
			ME-HFP	ME-HFP
			ME-HM	ME-HM
			ME-HMP	ME-HMP
	200	1976-1977	ME-HU	ME-HU
	240D	1976-	ME-HUP	ME-HUP
	300D	1976-	ME-NU	ME-NU
			ME-NUP	ME-NUP
	200	1977-1984	ME-HU	ME-HU
	230	1977-1984	ME-HUP	ME-HUP
	240	1977-	ME-HY	ME-HY
	250	1977-1984	ME-HYP	ME-HYP
	300	1977-1980	ME-NU	ME-NU
	380	1977-1979	ME-NUP	ME-NUP
			ME-NY	ME-NY
			ME-NYP	ME-NYP
	206D	-	ME-VA	ME-VA
	306D	-		
	207D	-1992	ME-HM	ME-HM
	207F	-1992	ME-HMP	ME-HMP
	207K	-1992		
	208D	-1992		
	209D	-1992		
	307D	-1992		
	308D	1992-		
	L 508	-1991		
	L 608	-1991		
	LN 914	-1991		
	MB 308DT	-1991		
	MB 408DT	-1991		
	U 900	-1991		
	U 1700	-1991		
220	-1972	ME-HF	ME-HF	
230	-1972	ME-HFP	ME-HFP	
250	-1972	ME-HZ	ME-HZ	
280	-1972	ME-HZP	ME-HZP	
300	-1972			
350	-1972			
7200	-1972			
230	-	ME-HF	ME-HF	
240	-	ME-HFP	ME-HFP	
280	-	ME-HM	ME-HM	
300	-	ME-HMP	ME-HMP	
TODO T. 4WD	-	ME-HZ	ME-HZ	
		ME-HZP	ME-HZP	



MARCA BRAND	MODELO MODEL				
MERCEDES	400	-1994	ME-2P	ME-2P	
	600	-1994	ME-3P	ME-3P	
	711	1996-	ME-HMP	ME-HMP	
	814	1996-			
	817	1996-			
	917	1996-			
	1117	1996-			
	1300	1996-			
	1500	1996-			
	SPRINTER	1996-			
	VARIO	1996-			
	MB 100D	-1994	ME-1	ME-1	
			ME-1P	ME-1P	
	MODELOS	-1970	NE-61D		
			NE-62		
	VITO	1996-	ME-HMP	ME-HMP	
			ME-HZ	ME-HZ	
			ME-HZP	ME-HZP	
	VITO	1997-	ME-HMLP	ME-HMLP	
	MG	MG	1970-1974	UN-NH	UN-FS
		MGB	1970-1974	UN-NHP	
		MGB GT	1970-1975		
		MG	1975-1977	NE-1	UN-FS
		MGB	1975-1978	NE-1P	
		MG	1978-	NE-10	UN-FS
			NE-10P	UN-FS	
MGF		1997	NE-10P	NE-10P	
MODELOS		-1970	UN-FP	UN-FP	
			UN-FS	UN-FS	
MICROCAR		FAMILY	2007-2009	SIX-3P	SIX-3P
		M.GO	2009		
	NEWSTREET	2008			
	PRATIC	2008			
	VIRGO	2008			
MITSUBISHI	3000 GT/R/SL	-	MIT-12	MIT-12	
	BRAVO	-	MIT-7	MIT-7	
	CHARIOT	1987-	MIT-7P	MIT-7P	
	COLT	1987-1993			
	DIAMANTE	1992-			
	ECLIPSE	1987-			
	ETERNA	1989-			
	EXPO	-			
	GALANT	1987-1996			
	L 200	1987-			
	L 300	1987-			
	LANCER	1987-1996			
	MINICAB	1987-			
	MIRAGE	1987-1993			
	MONTERO	1992-1996			
	MX SUPER A.R	-			
	NIMBUS	1987-			
PAJERO	1992-1996				
S.RUNNER	1992-1998				



AUTOMÓVIL - CAMIONETA

CAR - PICK-UP TRUCKS

MARCA BRAND	MODELO MODEL			
MITSUBISHI	SHOGUN	-		
	SPACE GEAR	1995		
	SPACE WAGON	1985-		
	CANTER	1997	MIT-15P	MIT-15P
	CELESTE	1972-1980	MIT-11	MIT-11
	COLT	1972-1980	MIT-11P	MIT-11P
	GALANT	1972-1980		
	LAMBDA	1972-1980		
	LANCER	1972-1980		
	MINICA	1972-1980		
	STARION	1972-1980		
	COLT	1981-1984	MIT-21	MIT-21
	CORDIA	1981-1984	MIT-21P	MIT-21P
	DEBONAIR	1981-1984		
	ETERNA	1981-1983		
	GALANT	1981-1983		
	L 300	-1983		
	L 300 VAN	1981-1984		
	LANCER	1981-1983		
	MINICA	1981-1983		
	MONTERO	1981-1992		
	PAJERO	1981-1992		
	SAPPORO	1981-1984		
	SHOGUN	1981-1984		
	SIGMA	1981-1984		
	SPACE WAGON	1981-1983		
	STARION	1981-1983		
	VISTA	-1993		
	COLT	1984-1987	MIT-3	MIT-3
	DEBONAIR	1983-1985	MIT-3P	MIT-3P
	ETERNA	1983-1989	MIT-4	MIT-4
	GALANT	1983-1987	MIT-4P	MIT-4P
	L 300	1983-1987		
	LANCER	1983-1987		
	MINICA	1983-1987		
	ORCHID	1983-1985		
	SPACE WAGON	1983-1985		
	STARION	1983-1985		
	TREDIA	1983-1985		
	COLT	1993-1996	MIT-13D	MIT-13D
	MIRAGE	1993-	MIT-14D	MIT-14D
			MIT-8D	MIT-8D
			MIT-8DP	MIT-8DP
	INTERCOOLER	1992-	CHR-17	CHR-17
			MIT-12	MIT-12
			MIT-7	MIT-7
			MIT-7P	MIT-7P
	L 400	1997-	MIT-7P	MIT-7P
	MODELOS	1985-1986	MIT-5	MIT-5
			MIT-5P	MIT-5P
			MIT-6	MIT-6
			MIT-6P	MIT-6P
	PRECIS	1986-	HY-3D	HY-3D



MARCA BRAND	MODELO MODEL				
MITSUBISHI			HY-3DP1	HY-3DP1	
	SUMMIT	1993-	MIT-8D	MIT-8D	
	VISTA	1993-	MIT-8DP	MIT-8DP	
	MOSKVITCH	408	-	NE-3	MOS-1
		412	-	NE-3P	VOL-3
		426	-	NE-3P1	
		427	-	NE-3P2	
		2135	-		
		2136	-		
		2137	-		
		2138	-		
		2140	-		
		2141 ALEKO	-	LA-3D	LA-3D
			LA-3DP	LA-3DP	
	NISSAN	200 SX	-1983	DAT-12	DAT-12
240 Z		-1983	DAT-6	DAT-6	
280 Z		-1983	DAT-6P	DAT-6P	
300 L		-1983	DAT-7	DAT-7	
300 ZX		-1983	DAT-7P	DAT-7P	
AUSTER		-1983			
AXXESS		-1983			
BLUEBIRD		-1983			
CEDRIC		-1983			
CHERRY		-1983			
EXA		-1983			
FAIRLADY		-1983			
GAZELLE		-1983			
GLORIA		-1983			
LANGLEY		-1983			
LAUREL		-1983			
LEOPARD		-1983			
LIBERTA VIL.		-1983			
MARCH		-1983			
MAXIMA		-1983			
MICRA		-1983			
PAO		-1983			
PINTARA		-1983			
PRAIRE		-1983			
PRESIDENT		-1983			
PULSAR		-1983			
SENTRA		-1983			
SILVIA		-1983			
SKYLINE		-1983			
STANZA		-1983			
SUNNY		1983-1989			
TULIP		-1983			
VANETTE		-1983			
VIOLET		-1983			
240 Z	1969-1973	DAT-5D	DAT-1D		
280 Z	1969-1973		DAT-1DP		
BLUEBIRD	1977-1979				
CHERRY	1977-1979				
SENTRA	1977-1979				



MARCA BRAND	MODELO MODEL			
NISSAN	SKYLINE	1977-1979		
	SUNNY	1977-1979		
	VIOLET	1977-1979		
	240 Z	1974-1983	DAT-5D	DAT-2D
	260 Z	1974-1983		DAT-2DP
	280 Z	1974-1983		DAT-2I
	280 ZX ST.W	1974-1983		DAT-2IP
	1200 DE LUXE	-1971		DAT-4I
	1200 VAN	-1971		
	1200 DE LUXE	1971-1972	DAT-8	DAT-7
			DAT-8P	DAT-7P
	BLUEBIRD	1970-1976	DAT-5D	DAT-8
	CHERRY	1970-1976		DAT-8I
	SENTRA	1970-1976		DAT-8IP
	SKYLINE	1970-1976		DAT-8IP1
	SUNNY	1970-1976		DAT-8P
	VIOLET	1970-1976		
	BLUEBIRD	1976-1979	DAT-1D	DAT-1D
			DAT-1DP	DAT-1DP
			DAT-1I	DAT-1I
			DAT-1IP	DAT-1IP
	BLUEBIRD	1980-1982	DAT-9D	DAT-9D
			DAT-9DP	DAT-9DP
			DAT-9I	DAT-9I
			DAT-9IP	DAT-9IP
	CEDRIC	1995-1997	DAT-15	DAT-15
	GLORIA	1995-1997	DAT-15P	DAT-15P
	PATHFINDER	1996-1997	DAT-16	DAT-16
	CHERRY	1980-1982	NE-11	DAT-1D
			NE-11P	DAT-1DP
				DAT-1I
				DAT-1IP
	FLORIDA	1989-1991	DAT-6	DAT-6
	PATROL 4x4	1986-	DAT-6P	DAT-6P
	SUNNY	1989-1991		
	TERRANO	1989-1995		
	TRADE	1989-		
	MAXIMA	1980-1982	DAT-2D	DAT-2D
			DAT-2DP	DAT-2DP
			DAT-2I	DAT-2I
		DAT-2IP	DAT-2IP	
MAXIMA	1991-1995	DAT-10	DAT-7	
		DAT-10P		
MICRA	1993-1995	DAT-10	DAT-10	
PRIMERA	1991-1995	DAT-10P	DAT-10P	
TERRANO	1995			
TERRANO II	1993-1995			
PATHFINDER	1991-	DAT-12	DAT-12	
SENTRA	1991-			
PATROL 4 WD	-1985	DAT-8	DAT-8	
		DAT-8P	DAT-8P	
QUEST	1993-	FO-8D	FO-8D	
		FO-8DP	FO-8DP	



MARCA BRAND	MODELO MODEL				
NISSAN			FO-8DP1	FO-8DP1	
	QUEST	1993-1994	DAT-19	DAT-19	
			DAT-19P	DAT-19P	
	QUEST	1996	DAT-20	DAT-20	
			DAT-20P	DAT-20P	
	SERENA	1993-1996	DAT-6	DAT-6	
			DAT-6P1	DAT-6P1	
	URVAN	-1994	DAT-12	DAT-12	
				DAT-1D	
				DAT-1DP	
	VANETTE	1983-1996	DAT-12	DAT-12	
			DAT-6	DAT-6	
			DAT-6P	DAT-6P	
	NISSAN (AUSTRALIA)	PINTARA	-1983	DAT-12	DAT-12
		PULSAR	-1983	DAT-6	DAT-6
			DAT-6P	DAT-6P	
			DAT-7	DAT-7	
			DAT-7P	DAT-7P	
NISSAN (USA)	810	1980-1982	DAT-2D	DAT-2D	
			DAT-2DP	DAT-2DP	
			DAT-2I	DAT-2I	
			DAT-2IP	DAT-2IP	
	810	1983-	DAT-12	DAT-12	
			DAT-6	DAT-6	
			DAT-6P	DAT-6P	
			DAT-7	DAT-7	
			DAT-7P	DAT-7P	
NSU	RO 80	-			
OM IVECO	40	-	AF-9D	AF-5D	
			AF-9DP	AF-5I	
			AF-9I	AF-6D	
			AF-9IP	AF-6I	
	50.10	1979-1981	LF-RO	IMS-3	
	60.10	1979-1981	LF-ROP	IMS-3P	
	65.10	1979		IMS-5	
	70.10	1979		IMS-5P	
	50.10	1981	SIP-1	IMS-3	
	60.10	1981		IMS-3P	
	70.10	1981		IMS-5	
	75.10	1981		IMS-5P	
	79.10	1981			
	79.13	1981			
	75	-	AF-9D	FI-5D	
			AF-9DP	FI-5I	
			AF-9I	IMS-3	
			AF-9IP	IMS-3P	
			FEM-1D	IMS-5	
			FEM-1I	IMS-5P	
	100.13	-	AF-8D	IMS-3	
	160	-	AF-8DP	IMS-3P	
	160.26	-	AF-8I	IMS-5	
			AF-8IP	IMS-5P	
			AF-9D		



AUTOMÓVIL - CAMIONETA

CAR - PICK-UP TRUCKS

MARCA BRAND	MODELO MODEL			
OM IVECO			AF-9DP	
			AF-9I	
			AF-9IP	
	100.13	-1978	AF-9D	IMS-3
	110.110P	-1978	AF-9DP	IMS-3P
	110.13	-1978	AF-9I	IMS-5
	130	-1978	AF-9IP	IMS-5P
			FEM-1D	
			FEM-1I	
	130	-	FEM-1D	IMS-3
	130 R	-	FEM-1I	IMS-3P
	130 R/H	-		IMS-5
	130 T/H	-		IMS-5P
	150 R20	-	AF-9D	FI-5D
	150 T20	-	AF-9DP	FI-5I
	150.20	-	AF-9I	IMS-3
	159.20	-	AF-9IP	IMS-3P
	190 T30	-		IMS-5
	190.30	-		IMS-5P
	190.35	-	AF-7I	IMS-3
	190.38	-	AF-7IP	IMS-3P
	190.38 TUR.	-	AF-9D	IMS-5
			AF-9DP	IMS-5P
			AF-9I	
			AF-9IP	
	330.26	-	VO-VB	IMS-3
	330.35	-	VO-VBP	IMS-3P
				IMS-5
				IMS-5P
	DAINO 145	-	BH-4	AF-5D
	LUPETTO	-		AF-5I
				AF-6D
				AF-6I
	GRINTA	-	AF-7I	IMS-3
			AF-7IP	IMS-3P
			FI-9I	IMS-5
			FI-9IP	IMS-5P
			LF-RO	
			LF-ROP	
	LEONCINO	-	BH-4	AF-4D
			AF-4I	
ORSETTO	-	FEM-1D	AF-5D	
		FEM-1I	AF-5I	
			AF-6D	
			AF-6I	
OPEL-VAUXHALL	ADMIRAL	-1973	OP-6	OP-6
	KADETT	-1973	OP-7	OP-7
	OLIMPIYA	-1973	OP-8	OP-8
	REKORD	-1973	OP-9	OP-9
			OP-BB	OP-BB
			OP-EE	OP-EE
			OP-FF	OP-FF
	ASCONA	-1974	OP-HA	OP-HA



MARCA BRAND	MODELO MODEL			
OPEL-VAUXHALL	MANTA	-1974	OP-HB	OP-HB
			OP-HG	OP-HG
			OP-HH	OP-HH
	ASCONA	1975-1981	OP-AB	OP-AB
	KADETT	1973-1983	OP-ABP	OP-ABP
	MANTA	1975-1981	OP-BA	OP-BA
			OP-BAP	OP-BAP
			OP-J	OP-J
			OP-JP	OP-JP
	ASCONA	1982-	OP-WHP	OP-WHP
	CALIBRA	1987-1995	OP-WYP	OP-WYP
	CARAVAN	1992-		
	COMMODORE	1982-		
	MANTA	1982-		
	MONZA	1984-		
	OMEGA	1987-1995		
	REKORD	1984-		
	VECTRA	1987-1995		
	ASTRA	1991-1995	OP-D	OP-D
	CORSA	1984-1995	OP-DP	OP-DP
	CORSA VAN	1984-1995	OP-S	OP-S
	KADETT	1984-	OP-SP	OP-SP
	ASTRA VAN	1991-1995	OP-D	OP-D
	COMBO	-	OP-DP	OP-DP
	FRONTERA	1992-1996	GM-4	GM-4
	MONTERREY	1992-	GM-4P	GM-4P
			GM-4P1	GM-4P1
	MANTA 1.8	1975-1979	OP-J	OP-J
			OP-JP	OP-JP
	MIDI	1992-	MIT-3	MIT-3
			MIT-3P	MIT-3P
	MONZA	1974-1981	OP-R	OP-R
	REKORD	1974-1984	OP-RP	OP-RP
	SENATOR	1984-	OP-T	OP-T
			OP-TP	OP-TP
	MONZA	1981-1984	GM-9	OP-R
	SENATOR	1981-1984	GM-9P	OP-RP
			GM-J	OP-T
			GM-JP	OP-TP
	TIGRA	1994	OP-SP1	OP-SP1
PEUGEOT	104	1972	LMP-1	VA-6
			LMP-1P	VA-6P
			NE-4	
			NE-4P	
			NE-4P1	
	104	1978	NE-4	NE-4
	504	1975-	NE-4P	NE-4P
	604	1975-1980	NE-4P1	NE-4P1
	104	1979	LMP-2	LAS-V
			LMP-2P	VA-6
			NE-4	VA-6P
			NE-4P	



MARCA BRAND	MODELO MODEL			
PEUGEOT			NE-4P1	
	104	1980	CHR-3	CHR-3
	104	1982-	CHR-3P	CHR-3P
	305	1978-1980	NE-22P1	NE-22P1
	305	1983-1987		
	505	1979-1980		
	505 BREAK	1981-1983		
	604	1981-		
	104	1981	LMP-4	LMP-4
	505 BERLINA	1981-1983	LMP-4P	LMP-4P
			LMP-5	LMP-5
			LMP-5P	LMP-5P
	106	1991-1997	NE-36	NE-36
			NE-36P1	NE-36P1
	106 SERVICE	-1993	NE-19	NE-19
	205 SERVICE	-1993	NE-20P1	NE-20P1
	309 SERVICE	1985-		
	405 AFFAIRE	1987-1991		
	204	1965-	NE-37	VA-6
	304	1969-1978	NE-37P	VA-6P
	404	1965-	NE-4	
	504 BERLINA	1968-1974	NE-4P	
			NE-4P1	
	205	1984	NE-20	NE-20
			NE-20P	NE-20P
			NE-29	NE-29
			NE-29P	NE-29P
	205	1985-1991	NE-20	NE-20
	505	1985-	NE-20P1	NE-20P1
			NE-29	NE-29
	205	1991-1993	NE-20	NE-20
	405	1991-1993	NE-20P1	NE-20P1
			NE-29	NE-29
			NE-36	NE-36
			NE-36P1	NE-36P1
	205	1993-	NE-20P2	NE-20P2
	405	1993-	NE-36	NE-36
			NE-36P1	NE-36P1
	305	1981-1982	SIX-1	SIX-1
			SIX-1P1	SIX-1P1
	305 SERVICE	1983-	CHR-3	CHR-3
			NE-22P1	NE-22P1
	306	1993-1997	NE-20P2	NE-20P2
			NE-36	NE-36
309	1985-	NE-20	NE-20	
405	1987-1991	NE-20P1	NE-20P1	
		NE-29	NE-29	
		NE-29P	NE-29P	
406	1995-1997	NE-51P2	NE-51P2	
504 BREAK	1968-1974	NE-4	RO-11D	
		NE-4P		
		NE-4P1		



MARCA BRAND	MODELO MODEL			
PEUGEOT	504 PICK UP	1975-	NE-4	NE-4
			NE-4P1	NE-4P1
	505	1984	NE-20	NE-20
			NE-20P	NE-20P
	505 SERVICE	1979-	CHR-3	LAS-R
			NE-22P1	LAS-V
	605	1990-	NE-34P	NE-34P
	806	1994	SIX-3P1	SIX-3P1
	EXPERT	1995-1996		
	J-5	-	FI-12	FI-12
			FI-12P3	FI-12P3
			FI-3D	FI-3D
			FI-3DP3	FI-3DP3
			FI-6I	FI-6I
	J-7	-	FI-6IP3	FI-6IP3
			NE-4	
			NE-4P1	
	J-9	-	NE-4	RO-4D
			NE-4P1	RO-4I
				RO-5D
				RO-5I
	PARTNER	1997	SIX-3P1	SIX-3P1
RANCH	1997	SIX-3P2	SIX-3P2	
PEUGEOT (AR-GEN.)	404	-	NE-3	NE-43
			NE-3P	
			NE-3P2	
405	-	NE-20	NE-20	
		NE-20P1	NE-20P1	
504	-	NE-3	NE-3	
		NE-3P	NE-3P	
		NE-3P2	NE-3P2	
		NE-4	NE-4	
		NE-4P	NE-4P	
504 PICK UP	-	NE-4	NE-4	
		NE-4P	NE-4P	
505	-	NE-20	NE-20	
		NE-20P1	NE-20P1	
		NE-42	NE-42	
		NE-42P	NE-42P	
		NE-42P1	NE-42P1	
PIAGGIO	PORTER	1993-1994	DAI-1P	DAI-1P
PORSCHE	911 CARRERA	1970-	PO-HC	PO-HC
	912	1970-	PO-HCP	PO-HCP
	914	1970-	PO-NC	PO-NC
			PO-NCP	PO-NCP
	924	1975-1993	VO-HV	VO-HV
	944	1975-1993	VO-HVP	VO-HVP
			VO-VB	VO-VB
			VO-VBP	VO-VBP
	928	1977-	PO-1P	PO-1P
			PO-2P	PO-2P



AUTOMÓVIL - CAMIONETA

CAR - PICK-UP TRUCKS

MARCA BRAND	MODELO MODEL					
PORSCHE	968	1993-	AU-AH	AU-AH		
			VO-AHP	VO-AHP		
PREMIER	118 NE	-	AF-7I	IMS-3		
			AF-7IP	IMS-3P		
			AF-9D	IMS-5		
			AF-9DP	IMS-5P		
			FEM-1D			
			FEM-1I			
			FEM-2D			
			FEM-2I			
			FO-FR			
			FO-FRP			
			SIP-2			
			PADMINI	-	FEM-1D	AF-4D
					FEM-1I	AF-4I
					FEM-2D	AF-5D
FEM-2I	AF-5I					
			AF-6D			
			AF-6I			
RAYTON FIS-SORE	MAGNUM 4x4	-	FI-1	FI-1		
			MAGNUM 4x4TD	-	FI-11	FI-11
			FI-11P	FI-11P		
			FI-1P	FI-1P		
	MAGNUM FORZA	-	GIQB-3P	GIQB-3P		
RENAULT	R 4	1961-1991	NE-4	NE-4		
			NE-4P	NE-4P		
			NE-4P1	NE-4P1		
			NE-4P2	NE-4P2		
	R 5	1972-1979	LMP-2	RO-15		
			LMP-2P	VA-7		
			NE-15D			
			NE-15DP			
			NE-15I			
				NE-15IP		
	R 5	1979	NE-15D	NE-16		
			NE-15DP	NE-59P		
			NE-15I			
				NE-15IP		
	R 5	1980				
	R 5	1981	CHR-3	VA-10		
	R 5	1983-1984	CHR-3P			
	R 5	1982	CHR-3	VA-10		
			CHR-3P			
			LMP-4			
			LMP-4P1			
			LMP-5			
			LMP-5P1			
R 5	1985-1986	NE-19	VA-10			
		NE-19P1				
R 5	1986-	NE-19	NE-28			



MARCA BRAND	MODELO MODEL			
RENAULT			NE-19P1	
	R 6	1968-	LMP-1	RO-15
			LMP-1P	
			NE-15I	
			NE-15IP	
	R 7	-	NE-15I	NE-16
			NE-15IP	NE-4
			NE-4	NE-4P2
			NE-4P2	NE-59P
	R 9	1981	CHR-3	NE-16
	R 11	1981	CHR-3P	NE-59P
			LMP-5	
			LMP-5P1	
	R 9	1982-1983	CHR-3	BS-5
	R 11	1982-1983	CHR-3P	NE-16
				NE-59P
				VA-10
	R 9	1984-	NE-19	NE-16
	R 11	1984-	NE-19P	NE-59P
				VA-10
				VA-17P
	R 12	1969-1971	LMP-1	RO-15
			LMP-1P	
R 12	1972-	LMP-2	VA-7	
		LMP-2P		
R 14	1976-1977	CHR-3	NE-16	
		CHR-3P	NE-59P	
		NE-15I		
		NE-15IP		
R 14	1978-1979	CHR-3	VA-7	
		CHR-3P		
R 14	1980-	CHR-3	NE-16	
		CHR-3P	NE-59P	
		LMP-4	VA-10	
		LMP-4P1		
		LMP-5		
		LMP-5P1		
R 15	1971-	NE-15I	RO-15	
R 17	1971-	NE-15IP		
R 16	1965-	NE-3	RO-15	
		NE-3P1		
		NE-3P2		
R 18	1978-1980	CHR-3	NE-16	
FUEGO	1978-1980	CHR-3P	NE-59P	
R 18	1980-1982	CHR-3	VA-10	
FUEGO	1982-	CHR-3P		
		LMP-5		
		LMP-5P1		
R 18	1983-	CHR-3	VA-10	
		CHR-3P		
		NE-19		
		NE-19P1		
		NE-22P		



MARCA BRAND	MODELO MODEL			
RENAULT	R 19	1988-1990	NE-19	NE-19
	ALPINE	1992-	NE-19P1	NE-19P1
	R 19	1990-	NE-19	NE-19
			NE-19P1	NE-19P1
			NE-36	NE-36
			NE-36P1	NE-36P1
	R 20	1975-	CHR-3	VA-17P
	R 30	1975-	CHR-3P	
			LMP-4	
			LMP-4P1	
			NE-22P	
	R 21	1986-1989	NE-19	NE-28
			NE-19P1	VA-10
	R 21	1990-1991	NE-36	NE-36
			NE-36P1	NE-36P1
	R 21	1992-	NE-38	NE-38
	R 25	1992-	NE-38P1	NE-38P1
	COACH	1995-1996		
	MEGANE	1995-1996		
	SAFRANE	1992-1995		
	R 25	1983-1988	NE-19	VA-17P
			NE-19P1	
	R 25	1989-1991	NE-36	VA-17P
			NE-36P1	
	CLIO	1990-1998	NE-36	NE-36
			NE-36P1	NE-36P1
VA-34			VA-34	
VA-34P			VA-34P	
ESPACE	1984-1997	NE-19	VA-10	
		NE-19P1		
		NE-36		
		NE-36P1		
LAGUNA	1994	NE-38	NE-38	
		NE-38P1	NE-38P1	
		VA-34	VA-34	
		VA-34P	VA-34P	
LAGUNA	1994-1995	VA-34P1	VA-34P1	
LAGUNA 2 ^o se.	1994	VA-34	NE-50P	
TWINGO	1993-1994	NE-36	NE-36	
		NE-36P	NE-36P	
		NE-36P	NE-36P	
		VA-34P1	VA-34P1	
TWINGO	1995	NE-36	NE-36	
		NE-36P	NE-36P	
		NE-36P	NE-36P	
		VA-34P1	VA-34P1	
RENAULT (ARGEN.)	FUEGO	-	CHR-3	NE-16
	R11	-	NE-22P	NE-59P
	R18	-		
	NEVADA	-	CHR-3	NE-28
			NE-22P	
	R 4	-	NE-3	NE-3
NE-3P			NE-3P	
NE-3P2			NE-3P2	
NE-4			NE-4	



MARCA BRAND	MODELO MODEL			
RENAULT (ARGEN.)			NE-4P	NE-4P
			NE-4P2	NE-4P2
	R 6	-	NE-3	NE-3
			NE-3P	NE-3P
			NE-3P2	NE-3P2
	R12	-	CHR-3	CHR-3
			NE-22P	NE-22P
			NE-4	NE-4
			NE-4P	NE-4P
			NE-4P2	NE-4P2
	R19	-	NE-36	NE-36
NE-36P1			NE-36P1	
R21	-	CHR-3	NE-28	
		NE-22P	VA-10	
TRAFFIC	-	CHR-3	NE-16	
		NE-22P	NE-53	
			NE-59P	
RENAULT SAVIEM	B 70.35	-1987	CHR-3	VA-7
	B 70.45	-1987	CHR-3P	
	B 90.35	-1987	LMP-5	
	MASTER P35 D	-1987	LMP-5P1	
	MASTER T30 D	-1987	NE-22P	
	MASTER T35 D	-1987		
	B 70.45	1988-1992	CHR-3	NE-28
	B 80.45	1992-	NE-22P	
	B 90.45	1988-1992		
	B 90.50	1988-1992		
	B 110.150	1992-		
	B 110.35	1992-		
	MASTER T30 D	1987-		
	MASTER T35 D	1987-		
	MASTER TURBO	1987-		
	EXPRESS-B-D	-1987	NE-19	NE-19
			NE-19P	NE-19P
			NE-19P1	NE-19P1
	EXPRESS-B-D	1987-1991	NE-19	NE-28
	SUPERCINCO D	-1991	NE-19P1	
JK 50-60	-	BH-1	RO-15	
JK 75-90	-	BH-1P	RO-4D	
JK 110-115	-		RO-4I	
JP 11	-	BH-1	RO-4D	
JP 13	-	BH-1P	RO-4I	
JP 13 TU	-			
JP 115	-			
R 11 CARGO	-1991	NE-19	VA-10	
		NE-19P1		
R 19 TD	-1992	NE-19	NE-19	
		NE-19P1	NE-19P1	
R4 F4 C. 850	-1994	NE-4	NE-4	
R4 F4 C.1100	-1994	NE-4P	NE-4P	
		NE-4P2	NE-4P2	
TRAFFIC	-1987	CHR-3	RO-17	



AUTOMÓVIL - CAMIONETA

CAR - PICK-UP TRUCKS

MARCA BRAND	MODELO MODEL			
RENAULT SAVIEM			CHR-3P	
			NE-22P	
	TRAFFIC	1988-	NE-19	NE-28
			NE-19P	
ROLLS ROYCE	ALGUNOS-SOME	1995	YA-20D	YA-20D
	CLOUD	-1970		
	SHADOW	-1970		
	CLOUD	1981-1997	YA-21I	YA-21I
	SHADOW	1981-1997		
	MODELOS	1970-1973	YA-18D	YA-18D
			YA-19D	YA-19D
			YA-20I	YA-20I
	SHADOW	1971-1980	YA-21I	YA-20D
	SPIRIT	1971-1980		YA-20I
	SPUR	1971-1980		
	WRAITH	1971-1980		
	SPIRIT	1980-1983	YA-20I	YA-20I
SPUR	1980-1983	YA-21I	YA-21I	
ROVER	2000	1976-1981	LF-RO	LF-RO
	2000	1985-	LF-ROP	LF-ROP
	2300	1976-1981		
	2300	1985-		
	2400	1976-1981		
	2400	1985-		
	2600	1976-1981		
	2600	1985-		
	3500	1976-1981		
	2000	1982-1985	LF-RO	LF-RO
	2200	1982-1985	LF-ROP	LF-ROP
	2300	1982-1985	NE-11	NE-11
	2400	1982-1985	NE-11P	NE-11P
	2600	1982-1985		
	3500	1982-1985		
	2000 SC/TC	1963-1975	LF-9	UN-4
	3500	1963-1975		
	25	2000-	NE-35P2	NE-35P2
	416	1995-1996		
	620	1995-1996		
	3500 V8 S	1976-	LF-9	UN-1FS
			LF-RO	UN-4
			LF-ROP	
	820	1992-1994	NE-52P	NE-52P
	825	1992-1994		
	ALLEGRO	1973-	LF-RO	UN-FT
			LF-ROP	
ALLEGRO 2	1973-	LF-BL	UN-FT	
		LF-RO		
		LF-ROP		
ALLEGRO 3	1973-	LF-BL	UN-FT	
		LF-RO		
		LF-ROP		
		NE-11		
		NE-11P		



MARCA BRAND	MODELO MODEL			
ROVER	FX 4S (TAXI)	-	LF-BL	IN-4
			LF-RO	IN-5
			LF-ROP	
	MAESTRO	1983-	NE-11	NE-11
	SERIE 200	1985-1989	NE-11P	NE-11P
	SERIE 800	1987-1991	NE-11P1	NE-11P1
			NE-11P2	NE-11P2
			NE-24	NE-24
			NE-24P	NE-24P
			NE-24P1	NE-24P1
	MARINA	-	LF-BL	UN-FT
			LF-RO	
			LF-ROP	
			NE-1	
			NE-1P	
	MAXI	1969-	NE-1	UN-FS
	TRAVELLER	1969-	NE-1P	
	METRO	1980-1983	NE-11	NE-14
	METRO	1984-1989	NE-11P	
	MINI	1959-1973	UN-FS	UN-FS
	MINI	1974-1984	LF-BL	UN-FS
			LF-RO	
			LF-ROP	
	MINI	1985-	NE-11	UN-FS
			NE-11P1	
			NE-11P2	
	MONTEGO	1984-1988	NE-11	NE-14
			NE-11P	
			NE-24	
			NE-24P	
	MONTEGO	1988-1991	NE-11	NE-11
			NE-11P1	NE-11P1
			NE-11P2	NE-11P2
		NE-24	NE-24	
		NE-24P1	NE-24P1	
MONTEGO	1992-	NE-35	NE-35	
		NE-35P	NE-35P	
PRINCESS	-	NE-11	LF-RO	
		NE-11P	LF-ROP	
SERIE 100	1991-1993	NE-11	NE-11	
		NE-11P1	NE-11P1	
		NE-11P2	NE-11P2	
SERIE 200	1984	HOND-10	HOND-10	
		HOND-10P	HOND-10P	
SERIE 200	1989-1993	NE-35	NE-35	
SERIE 400	1989-1993	NE-35P2	NE-35P2	
SHERPA 185	-	LF-BL	UN-1FS	
SHERPA 230	-	LF-RO	UN-FT	
SHERPA 255	-	LF-ROP		
SAAB	93	1998	SAA-1P1	SAA-1P1
	900	1993-		
	9000	1986-		
	95	-	AS-1D	SAA-AC



MARCA BRAND	MODELO MODEL			
SAAB	96	-	SAA-AC SAA-ACP	SAA-ACP
	99	1974-1977	SAA-2P	SAA-2P
	900	1974-1977		
	900	1978-1993	SAA-AC SAA-ACP	SAA-AC SAA-ACP
SEAT	124	1970-	FI-9I	IMS-3
			FI-9IP	IMS-3P
				IMS-5
				IMS-5P
	127	1972-	FI-9I	IMS-3
	131	1972-1975	FI-9IP	IMS-3P
			IMS-7	IMS-5
			IMS-7P	IMS-5P
			SIP-3	
	131	1975-	CL-7P	CL-7P
			FI-2D	FI-3D
			FI-2DP3	FI-3DP
			FI-3D	
			FI-3DP	
	132	1973-	AF-7I	IMS-3
			AF-7IP	IMS-3P
			FI-8I	IMS-5
			FI-8IP	IMS-5P
			FO-FR	
			FO-FRP	
	CORDOBA	1993-1995	AU-AH	AU-AH
	EMELBA	1993-	AU-AHP	AU-AHP
	IBIZA	1993-1995	SE-AHP	SE-AHP
	POKER	1993-	VO-2	VO-2
	TOLEDO	1991-1995	VO-2P	VO-2P
	EMELBA	1984-1987	CL-6	CL-6
	GREDOS (GRE)	-	CL-6P	CL-6P
IBIZA	1984-1987			
MALAGA	1985-1990			
POKER	1984-1987			
RONDA	1985-			
EMELBA	1988-1992	AU-HV	AU-HV	
IBIZA	1988-1992	CL-9P	CL-9P	
POKER	1988-1992	VO-HV	VO-HV	
FURA	1972-1982	CL-7P	IMS-3	
		FI-3D	IMS-3P	
		FI-3DP	IMS-5	
		FI-8I	IMS-5P	
		FI-8IP		
		IMS-7 IMS-7P		
MARBELLA	1987-1992	CL-6	IMS-3	
TERRA	-	CL-6P	IMS-3P	
			IMS-5	
			IMS-5P	
MARBELLA	1993-1997	AU-AH	AU-AH	



MARCA BRAND	MODELO MODEL			
SEAT			AU-AHP	AU-AHP
			CL-6	CL-6
			CL-6P	CL-6P
			SE-AHP	SE-AHP
			VO-2	VO-2
			VO-2P	VO-2P
	PANDA	1980-1986	FI-8I	IMS-3
			FI-8IP	IMS-3P
			FI-9I	IMS-5
			FI-9IP	IMS-5P
	RITMO	-	CL-7P	CL-7P
RONDA	1982-1984	FI-3D	FI-3D	
		FI-3DP	FI-3DP	
TRANS	-	CL-6	IMS-3	
		CL-6P	IMS-3P	
		FI-9I	IMS-5	
		FI-9IP	IMS-5P	
SKODA	100	1982-1984	SKO-1	
	105	1982-1984	SKO-1P	
	110	1982-1984	SKO-2	
	120	1982-1984		
	110	1985-	SKO-1	
	120	1985-	SKO-1P	
	130	1985-		
	135	1985-		
	ESTELLE	1985-		
	GARD LUXE	1985-		
	RAPIDE	1985-		
	FAVORIT	1987-	SKO-3I	SKO-3I
	FORMAN	1987-	SKO-3IP	SKO-3IP
	SILVER	1993-		
	FELICIA	1995	SKO-5P	SKO-5P
	PICK-UP	1995		
	MODELOS	1964-1981	SKO-8	SKO-4
SSANGYONG	KORANDO	2000-	HY-5	HY-5
			HY-5P	HY-5P
	MUSSO	1995-	HY-3P2	HY-3P2
STERLING	SERIE 800	-	NE-11	
			NE-11P	
			NE-24	
			NE-24P	
STEYR-PUCH	19 S31	-1994	NE-58D	
	19 S37	-1994		
	26 S31	-1994		
	32 S31	-1994		
	230	-1979	ME-HZ	ME-HZ
	240	-1979	ME-HZP	ME-HZP
	280	-1979		
	300	1979-		
	230	1979-	ME-HF	ME-HF
	240	1979-	ME-HFP	ME-HFP
	280	1979-	ME-HM	ME-HM
			ME-HMP	ME-HMP



AUTOMÓVIL - CAMIONETA

CAR - PICK-UP TRUCKS

MARCA BRAND	MODELO MODEL			
STEYR-PUCH	PANDA 4x4	1983-1985	AF-7I	IMS-3
			AF-7IP	IMS-3P
			FI-9I	IMS-5
			FI-9IP	IMS-5P
	PANDA 4x4	1986-1988	FI-1	IMS-3
			FI-11	IMS-3P
			FI-11P	IMS-5
			FI-1P	IMS-5P
	PANDA 4x4	1989-	FI-1	FI-1
			FI-11	FI-11
			FI-11P	FI-11P
			FI-1P	FI-1P
SUBARU	ALCYONE	1986-	DAT-6	DAT-6
	E10 VAN	1986-	DAT-6D	DAT-6D
	E12 VAN	1986-	DAT-6DP	DAT-6DP
	E5 VAN	1986-	DAT-6DP1	DAT-6DP1
	E7 VAN	1986-	DAT-6P	DAT-6P
	HUNTER	1986-	DAT-6P1	DAT-6P1
	JUSTY (EU)	1986-1996		
	L 1.3	1986-		
	L 1.6	1986-		
	L 1.8	1986-		
	LEGACY 4WD	1986-1996		
	LEONE	1986-		
	M 70	1986-		
	M 80	1986-		
	SAMBAR VAN	1986-		
	XT	1986-		
	E10 DOMINGO	1984-1985	DAT-11D	DAT-8I
	JUSTY	1984-1985	DAT-11DP	DAT-8IP
	L 1.3	1984-1985	WAS-2P	DAT-8IP1
	L 1.6	1984-1985		
	L 1.8	1984-1985		
	M 70	1984-1985		
	M 80	1984-1985		
	REX	1984-1985		
	HATCBACK	1985-	DAT-6	DAT-6
	JUSTY XT	1985-1996	DAT-6P	DAT-6P
	LEGACY	1985-1996	DAT-6P1	DAT-6P1
	LOYALE	1985-	DAT-7	DAT-7
			DAT-7P	DAT-7P
	IMPREZA	1995	DAT-6	DAT-6
			DAT-6P1	DAT-6P1
	JUSTY	1991-1996	DAT-6	DAT-7
			DAT-6P1	
	LEONE	1973-1982	DAT-11D	DAT-1D
	REX	1973-1982	DAT-11DP	DAT-1DP
	SEDAN	1973-1982	WAS-2P	DAT-1I
	TIGRE	1973-1982		DAT-1IP
				DAT-2D
				DAT-2DP
				DAT-2I
				DAT-2IP



MARCA BRAND	MODELO MODEL				
SUBARU	LEONE	1983-1984	DAT-11D	DAT-2I	
	REX	1983-1984	DAT-11DP	DAT-2IP	
	SEDAN	1983-1984	WAS-2P		
	TIGRE	1983-1984			
	MODELOS	1970-1972	DAT-1I	DAT-1I	
			DAT-1IP	DAT-1IP	
	MODELOS	2000-	DAT-15	DAT-15	
	SULKY	50	-1991	BH-4	ZA-1
		125	-1991		ZA-1P
	SUNBEAM	1.0	-	LF-SL	LF-SL
	1.3	-	LF-SLP	LF-SLP	
	1.6	-			
SUZUKI	ALTO	1976-1984	TOYO-14	TOYO-14	
	CERVO	1976-1984	TOYO-14P	TOYO-14P	
	CULTUS	1976-1984			
	ESTEEM	1976-1984			
	FRONTE	1976-1984			
	GOLD FINGER	1976-1984			
	JIMMY	1976-1984			
	S.CARRY	1988			
	SAMURAI	1976-1984			
	SJ 30	1976-1984			
	SJ 310	1976-1984			
	SJ 410	1976-1984			
	SJ 413	1976-1984			
	VITARA	1988			
	ALTO	1986-1995	SUZU-7	SUZU-7	
	CERVO	1986-	SUZU-7P	SUZU-7P	
	CULTUS	1986-			
	ALTO	1996	SUZU-8	SUZU-8	
	CARRY VAN	1989-1991	SUZU-8P	SUZU-8P	
	EVERY VAN	1989-1991			
	SWIFT	1989-1991			
	VITARA	1989-1991			
	VITARA	1991			
	X-90	1995-1997			
BALENO	1995	SUZU-10	SUZU-10		
ESCUDO	1989-1991	SUZU-10P	SUZU-10P		
SIDEKICK	1989-1991				
SWIFT	1991-1996				
CULTUS	1984-1991	MIT-2I	MIT-2I		
SAMURAI	1984-1989	TOYO-14	TOYO-14		
		TOYO-14P	TOYO-14P		
LJ 50	1970-	TOYO-14	TOYO-14		
LJ 80	1970-	TOYO-14P	TOYO-14P		
		TOYO-K1	TOYO-K1		
		TOYO-K1P	TOYO-K1P		
SAMURAI	1989-	IMS-11P	IMS-11P		
		SUZU-9P	SUZU-9P		
SJ 410	1985-1988	IMS-7	IMS-10		
SJ 413	1985-1988	IMS-7P			
SJ 410	1989-1991	IMS-7	IMS-11P		



MARCA BRAND	MODELO MODEL			
SUZUKI	SJ 413	1989-1991	IMS-7P	SUZU-9P
TALBOT SIMCA	150	1975-	LMP-3	LMP-3
	1510	1975-	LMP-3P	LMP-3P
	ALPINE	1975-		
	HORIZON	1980-1983		
	MINX	1980-1983		
	OMNI	1980-1983		
	RAPIER	1975-		
	160 GT	1979-	CHR-3	CHR-3
	180	1979-	NE-22P2	NE-22P2
	1307	1975-		
	1308	1975-		
	1309	1978-		
	HORIZON	1984-		
	MINX	1984-		
	MURENA	1980-		
	OMNI	1984-		
	1000	1968-1973	NE-3	RO-3
	1005	1968-1973	NE-3P1	
	1006	1968-1973	NE-3P2	
	1007	1968-1973		
	1100	1968-1973		
	1301	1970-1973		
	1501	1970-		
	1100	1974-	CHR-3 NE-22P2	RO-3
	BAGHEERA	1973-	NE-3 NE-3P1 NE-3P2	
	HORIZON	1977-1979	CHR-3	CHR-3
	HORIZON GL	1977-1979	NE-22P2	LMP-3
	MINX	1977-1979		LMP-3P
	OMNI	1977-1979		NE-22P2
	RANCH	1977-	CHR-3 NE-22P2	
	RAPIER	1980-	CHR-3	CHR-3
	SAMBA	1981-1983	NE-22P2	NE-22P2
	SOLARA	1980-	NE-33P1	NE-33P1
	TAGORA	1980-		
	SAMBA	1984-	CHR-3 NE-22P2 NE-33P1	CHR-3 NE-22P2 VA-6 VA-6P
TATA	INDICA	2000-	TAT-1D TAT-1DP	TAT-1D TAT-1DP
TOYOTA	3 DR LIFT B.	1988-1989	TOYO-12	TOYO-12
	4 RUNNER	1988-1989	TOYO-12P1	TOYO-12P1
	CELICA	1988-1989	TOYO-8	TOYO-8
	COROLLA	1988-1989	TOYO-8P	TOYO-8P
	MR2	1989-1990		
	SUPRA EFI SR	1988-1989		
	TERCEL	1989-		
	4 RUNNER	1970-1986	TOYO-12	TOYO-12



MARCA BRAND	MODELO MODEL			
TOYOTA	L. CRUISER	1970-1986	TOYO-12P1	TOYO-12P1
			TOYO-2	TOYO-2
			TOYO-K1	TOYO-K1
			TOYO-K1P	TOYO-K1P
	4 RUNNER	1986-1988	TOYO-16	TOYO-16
	CAMRY	1990-1991	TOYO-16P	TOYO-16P
	DYNA	1990-	TOYO-16P1	TOYO-16P1
	L. CRUISER	1986-1989	TOYO-5	TOYO-5
	LITEACE	1990-	TOYO-5P	TOYO-5P
	RUNNER	1986-1989	TOYO-5P1	TOYO-5P1
	STARLET	1990-1997		
	VX TURBO	1986-1989		
	4 RUNNER	1990-1991	TOYO-20D	TOYO-20D
	CARINA	1990-1994	TOYO-9	TOYO-9
	CELICA COUPE	1991-1996	TOYO-9P	TOYO-9P
	COROLLA	1990-1991	TOYO-9P1	TOYO-9P1
	CRESSIDA	1990-		
	HIACE VAN	1990-		
	HILUX 4x4	1995		
	HILUX VAN	1990-		
	L. CRUISER	1990-1991		
	MR2	1991-1997		
	RUNNER	1990-1991		
	4 RUNNER	1991-	TOYO-15	TOYO-15
	CAMRY	1991-	TOYO-15P	TOYO-15P
	CARINA S.W.	1995		
	CELICA	1995		
	COROLLA	1991-1996		
	RAV4	1995		
	RUNNER	1991-		
	ARROW	1970-1972	TOYO-4	TOYO-4
	CELICA SUPRA	1982-1985	TOYO-4P	TOYO-4P
	CROWN	1970-1972		
	CAMRY	1984-1989	TOYO-13 TOYO-13P1 TOYO-28P	TOYO-13 TOYO-13P1 TOYO-28P
	CAMRY GL	1984-	TOYO-3	TOYO-3
	CAMRY GLI	1984-	TOYO-3P	TOYO-3P
	CARINA	1983-1985	TOYO-8	TOYO-8
	COROLLA	1975-1982	TOYO-8P	TOYO-8P
	COROLLA 4DR	1986-1996		
	CORONA	1983-1985		
	CORSA	1983-1985		
	CRESSIDA	1983-1985		
	CRESTA	1983-1985		
	CROWN	1983-1985		
	MARK II	1983-1985		
	MR2	1983-1985		
	SPRINTER	1983-1985		
	TERCEL	1983-1985		
	CARINA	1972-1982	TOYO-14	TOYO-14
	CELICA	1972-1982	TOYO-14P	TOYO-14P
	COROLLA	1972-1974	TOYO-K1	TOYO-K1



AUTOMÓVIL - CAMIONETA

CAR - PICK-UP TRUCKS

MARCA BRAND	MODELO MODEL			
TOYOTA	CORONA	1972-1974	TOYO-K1P	TOYO-K1P
	CROWN	1972-1982		
	HIACE	1975-1982		
	HILUX	1973-1978		
	MARK II	1972-1982		
	PUBLICA	1972-1974		
	STARLET	1972-1982		
	CARINA	1985-1986	TOYO-3	TOYO-3
	CORONA	1985-1986	TOYO-3P	TOYO-3P
	SPRINTER	1985-1986		
	TERCEL 4WD	1985-1986		
	CARINA	1994	TOYO-19P	TOYO-19P
	CELICA	1983-1985	TOYO-12	TOYO-12
			TOYO-12D	TOYO-12D
			TOYO-12P1	TOYO-12P1
			TOYO-22	TOYO-22
			TOYO-22D	TOYO-22D
			TOYO-3	TOYO-3
			TOYO-3P	TOYO-3P
			TOYO-8	TOYO-8
			TOYO-8P	TOYO-8P
			TOYO-K1	TOYO-K1
			TOYO-K1P	TOYO-K1P
	CELICA	1986-1988	TOYO-10	TOYO-10
	COROLLA ST	1988-1989	TOYO-10P	TOYO-10P
	TERCEL	1987-1988	TOYO-11	TOYO-11
			TOYO-11P	TOYO-11P
	CELICA	1990-1995	TOYO-10	TOYO-10
			TOYO-10P	TOYO-10P
			TOYO-10P1	TOYO-10P1
			TOYO-11	TOYO-11
			TOYO-11P	TOYO-11P
			TOYO-11P1	TOYO-11P1
			TOYO-20D	TOYO-20D
			TOYO-9	TOYO-9
			TOYO-9P	TOYO-9P
			TOYO-9P1	TOYO-9P1
	CELICA 4WD	1990-1991	TOYO-10	TOYO-10
	MR2	1990-1991	TOYO-10P	TOYO-10P
	PREVIA	1993-1997	TOYO-10P1	TOYO-10P1
			TOYO-11	TOYO-11
			TOYO-11P	TOYO-11P
			TOYO-11P1	TOYO-11P1
	CELICA COUPE	1991-1994	TOYO-37D	TOYO-37D
	CELICA LIFT.	1991-1996	TOYO-10	TOYO-10
		TOYO-10P1	TOYO-10P1	
COROLLA	1983-1987	TOYO-12	TOYO-12	
TERCEL	1985-1987	TOYO-12P1	TOYO-12P1	
		TOYO-22	TOYO-22	
		TOYO-22D	TOYO-22D	
		TOYO-K1	TOYO-K1	
		TOYO-K1P	TOYO-K1P	
COROLLA 5	1972-1976	TOYO-2	TOYO-2	



MARCA BRAND	MODELO MODEL			
TOYOTA			TOYO-4	TOYO-4
			TOYO-4P	TOYO-4P
	COROLLA DX	1985-1996	TOYO-23	TOYO-23
	CRESSIDA	1977-1978	TOYO-23P	TOYO-23P
	CRESTA	1977-1978		
	COROLLA GT	1985-1996	TOYO-8	TOYO-8
			TOYO-8P	TOYO-8P
	COROLLA SM	1973-1978	TOYO-14	TOYO-14
			TOYO-14P	TOYO-14P
			TOYO-4	TOYO-4
			TOYO-4P	TOYO-4P
			TOYO-K1	TOYO-K1
			TOYO-K1P	TOYO-K1P
	COROLLA SW	1993-1996	TOYO-17	TOYO-17
			TOYO-17P	TOYO-17P
	CRESSIDA	1984-1987	TOYO-28P	TOYO-28P
	CRESSIDA	1985-1987	TOYO-13	TOYO-13
			TOYO-13P1	TOYO-13P1
	FX 16	1987-1988	TOYO-K1	TOYO-K1
	STARLET	1984-1990	TOYO-K1P	TOYO-K1P
	HDJ 80	1991-	TOYO-18P	TOYO-18P
	L. CRUISER	1991-		
	PASEO	1991-1997	TOYO-10	TOYO-10
			TOYO-10P	TOYO-10P
			TOYO-10P1	TOYO-10P1
VARIOS	-1969	TOYO-25	TOYO-25	
VARIOS	1970-	TOYO-29	TOYO-29	
TRABANT	TODOS	-	DOB-1	DOB-1
			DOB-1D	DOB-1D
			DOB-2	DOB-2
			DOB-2D	DOB-2D
			DOB-3	DOB-3
			DOB-3D	DOB-3D
TRIUMPH	ACCLAIM	1981-	HOND-1	HOND-1
			HOND-1P	HOND-1P
			HOND-2	HOND-2
			HOND-2P	HOND-2P
DOLOMITE	1973-	UN-NH	UN-FS	
TOLEDO	1973-	UN-NHP		
GT6 MK3	-	FO-FR	UN-NH	
		FO-FRP	UN-NHP	
		UN-NH		
		UN-NHP		
		WAS-2P		
GTX MK3	1972	FO-FR	UN-NH	
SPITFIRE	1972-1974	FO-FRP	UN-NHP	
SPITFIRE MK4	1972	WAS-2P		
MODELOS	-1969	UN-FS	UN-44	
			UN-FP	
SPITFIRE	1974-1978	LF-WB	UN-NH	
		LF-WBP	UN-NHP	
SPITFIRE	1979-	UN-NH		
		UN-NHP		



MARCA BRAND	MODELO MODEL			
TRIUMPH	TR6 PJ SPID.	1969-1977	FO-FR FO-FRP WAS-2P	UN-FT UN-NH UN-NHP
	TR7 COUPE	1975-1981	UN-NH	UN-FT
	TR7 SPIDER	1975-1981	UN-NHP	UN-NH
				UN-NHP
UAZ	452	-	BH-1	IMS-3
	469	-	BH-1P	IMS-3P
	469 DIESEL	-	VOL-2	IMS-5
			VOL-3	IMS-5P
				VOL-2 VOL-3
	FURGON 4R.M	-	VOL-2	IMS-3
				IMS-3P
				IMS-5
				IMS-5P
	ROAD MASTER	-	BS-6	
VAUXHALL	ASTRA	1975-1979	OP-J	OP-J
	CHEVRETTE	1975-1979	OP-JP	OP-JP
	ASTRA	1984-1995	OP-D	OP-D
	ASTRAMAX	1984-	OP-DP	OP-DP
	BELMONT	1984-	OP-S	OP-S
	NOVA	1984-	OP-SP	OP-SP
	ROYALE	1984-		
	CARLTON	1978-1981	OP-R	OP-R
	VICEROY	1978-1989	OP-RP	OP-RP
			OP-T	OP-T
			OP-TP	OP-TP
	CARLTON	1982-	OP-WHP	OP-WHP
	CAVALIER	1982-	OP-WYP	OP-WYP
	SENATOR	1982-		
	CAVALIER	1975-1981	OP-AB	OP-AB
			OP-ABP	OP-ABP
			OP-BA	OP-BA
			OP-BAP	OP-BAP
			OP-J	OP-J
			OP-JP	OP-JP
FIRENZA	-	LF-RO LF-ROP	LF-6	
VOLGA	GAZ 024	-	VOL-1	VOL-1
			VOL-1P	VOL-1P
	GAZ 029	-	NE-3	VOL-1
			NE-3P	VOL-1P
			NE-3P2	VOL-2
				VOL-2D VOL-3
	GAZ 3110	-	NE-3	VOL-1
			NE-3P	VOL-1P
			NE-3P2	VOL-4 VOL-5P
VOLKSWAGEN	411	1970-1972	VO-K	
	412	1970-1972		
	1500	1970-1972		



MARCA BRAND	MODELO MODEL			
VOLKSWAGEN	1600	1970-1972		
	BRASILIA	1970-1972		
	411	1973-1974	VO-VB	VO-VB
	412	1973-1974	VO-VBP	VO-VBP
	BRASILIA	1973-1974		
	CABRIOLET	1975-1981		
	DERBY AMAZON	1977-1980		
	FAMILCAR	1977-1980		
	GOLF	1977-1980		
	IGALA	1973-1974		
	PASSAT	1973		
	PASSAT	1977-1980		
	POLO	1975-1976		
	POLO	1977-1980		
	SCIROCCO	1975-1981		
	1303 CABRIO	1970-	HU-SU	VO-M VO-MP
	ALL STAR	1991-	VO-2	VO-2
	CALIFORNIA	1991-	VO-2P	VO-2P
	CLUB VAN	1991-		
	POLO	1991-1995		
	SINCRO	1991-		
	TRANSPORTER	1991-1995		
	BEETLE	1970-1978	VO-M	VO-M
	EL VOLKSWAGE	1970-1978	VO-MP	VO-MP
	ESCARABAJO	1970-1978		
	FUSCA	1970-1978		
	CADDY	-	AU-1	AU-1
	POLO	1981-1982	AU-HV	AU-HV
			AU-HVP	AU-HVP
			VO-HV	VO-HV
			VO-HVP	VO-HVP
	CORRADO	1988-	AU-AN	AU-AN
	GOLF	1988-1990	AU-ANP	AU-ANP
	GOLF	1991-1995	HU-AN	HU-AN
	JETTA ATLAN.	1988-	VO-2	VO-2
	PASSAT	1988-1995	VO-2P	VO-2P
	VENTO	1992-1995		
	DERBY AMAZON	1981-1982	AU-1	AU-1
	DERBY AMAZON	1985-1987	AU-HV	AU-HV
GOLF	1981-1982	AU-HVP	AU-HVP	
GOLF	1985-1987	VO-HV	VO-HV	
GOLF CABRIO	1981-1984	VO-HVP	VO-HVP	
JETTA ATLAN.	1981-1984	VO-VB	VO-VB	
JETTA ATLAN.	1985-1987	VO-VBP	VO-VBP	
PASSAT	1981-1984			
PASSAT	1985-1987			
POLO	1985-1991			
SANTANA	1981-1982			
SCIROCCO	1981-1982			
SCIROCCO	1985-1987			
GOLF	1975-1977	VO-VB	HU-SU VO-VB	
		VO-VBP		



AUTOMÓVIL - CAMIONETA

CAR - PICK-UP TRUCKS

MARCA BRAND	MODELO MODEL				
VOLKSWAGEN				VO-VBP	
	GOLF	1987-1988	VO-2 VO-2P VO-AHP	VO-2 VO-2P VO-AHP	
	K 70	1970-1973	FO-PN	FO-PN	
	K 70 LS	1970-1973	VO-VB VO-VBP	VO-VB VO-VBP	
	LT 28D	1970-1979	VO-R	VO-R	
	LT 31	1970-1979	VO-RP	VO-RP	
	PASSAT FAM.	1973-1976			
	TL 31	1970-1979			
	TL 45	1970-1979			
	TL 50	1970-1979			
	MODELOS	1966-1969	FO-D VO-L	VO-L	
	TARO NISSAN	1989-	TOYO-20D TOYO-9 TOYO-9P TOYO-9P1	TOYO-20D TOYO-9 TOYO-9P TOYO-9P1	
	TL 31	1980-	VO-N	VO-N	
	TL 35	1980-	VO-NP	VO-NP	
	TL 45	1980-			
	TL 50	1980-			
	TRANSPORTER	1980-1991			
	VAGON	1980-			
	VOLKSWAGEN (ARGEN.)	1500	-		CHR-8 CHR-8P
		1500	1980-		
1800		1980-			
GACEL		-	VO-FHP1	VO-FHP1	
GOL		-1995	VO-FHP1 VO-VB VO-VBP	VO-FHP1 VO-VB VO-VBP	
GOL		1996	VO-2DP	VO-2DP	
GOL		1997-	VO-8P	VO-8P	
KOMBI		-	VO-R VO-RP	VO-R VO-RP	
POINTER		-	VO-5P	VO-5P	
SAVEIRO		-	VO-HV VO-HVP VO-VB VO-VBP	VO-HV VO-HVP VO-VB VO-VBP	
SENDA		-	VO-HV VO-HVP	VO-HV VO-HVP	
VOLKSWAGEN (BRASIL)		FOX	1975-1976	VO-VB	VO-VB
		FOX	1977-1980	VO-VBP	VO-VBP
		GOL	1975-1976		
		GOL	1977-1980		
	PARATI	1973			
	PARATI	1977-1980			
	QUANTUM	1973			
	QUANTUM	1977-1980			
	FOX	1981-1982	AU-1	AU-1	

MARCA BRAND	MODELO MODEL				
VOLKSWAGEN (BRASIL)	GOL	1981-1982	AU-HV AU-HVP VO-HV VO-HVP	AU-HV AU-HVP VO-HV VO-HVP	
	FOX	1985-1991	AU-1	AU-1	
	GOL	1985-1991	AU-HV	AU-HV	
	PARATI	1981-1984	AU-HVP	AU-HVP	
	PARATI	1985-1987	VO-HV	VO-HV	
	QUANTUM	1981-1984	VO-HVP	VO-HVP	
	QUANTUM	1985-1987	VO-VB	VO-VB	
	SANTANA	1981-1982	VO-VBP	VO-VBP	
	FOX	1991-	VO-2	VO-2	
	GOL	1991-	VO-2P	VO-2P	
	PARATI	1988-	AU-AN	AU-AN	
	QUANTUM	1988-	AU-ANP HU-AN VO-2 VO-2P	AU-ANP HU-AN VO-2 VO-2P	
	VARIOS	1996-	VO-2DP1 VO-2P1 VO-8P1	VO-2DP1 VO-2P1 VO-8P1	
	VOLKSWAGEN (CHINA)	SHANGHAI	1973	VO-VB	VO-VB
		SHANGHAI	1977-1980	VO-VBP	VO-VBP
SHANGHAI		1981-1984	AU-1	AU-1	
SHANGHAI		1985-1987	AU-HV AU-HVP VO-HV VO-HVP VO-VB VO-VBP	AU-HV AU-HVP VO-HV VO-HVP VO-VB VO-VBP	
SHANGHAI		1988-	AU-AN AU-ANP HU-AN VO-2 VO-2P	AU-AN AU-ANP HU-AN VO-2 VO-2P	
VOLKSWAGEN (MEXICO)		ESCARABAJO	-	VO-M VO-MP	VO-M VO-MP
		VOLVO	66 DL	1972-1976	
66 GL			1972-1976		
66 L			1972-1976		
66 MARATHON			1972-1976		
66 SL	1972-1976				
142	1968-1972		NE-13	UN-FR	
144	1968-1972				
145	1968-1972				
164	1968-1972				
142	1973-1976		NE-10	NE-9	
144	1973-1976		NE-10P	NE-9P	
145	1973-1976			WAS-1	
164	1973-1976				
240	1973-1976				

MARCA BRAND	MODELO MODEL			
VOLVO	242	1973-1976		
	244	1973-1976		
	264	1973-1976		
	240	1977-1978	NE-12	NE-9
	242	1977-1978	NE-12P	NE-9P
	244	1977-1978		
	245	1977-1978		
	246	1977-1978		
	262	1977-1978		
	264	1977-1978		
	265	1977-1978		
	240	1978-1984	NE-12	NE-12
	242	1978-1983	NE-12P	NE-12P
	244	1978-1983		
	245	1978-1983		
	262	1978-1983		
	264	1978-1983		
	265	1978-1983		
	240	1984-1985	NE-12	NE-12
	740	1986-1991	NE-12P	NE-12P
	760	1984-1987	NE-18	NE-18
	780	1986-1991	NE-18P	NE-18P
	940	1991-1996		
	340	1976-1984	HU-DF	AKS-1
	343	1976-1984	HU-DFP	
	345	1976-1984	HU-DFP1	
	360	1976-1984		
	340	1985-1986	HU-DF	HU-DF
	360	1985-1986	HU-DFP	HU-DFP
			HU-DFP1	HU-DFP1
	440	1987-	HU-DHP	HU-DHP
	460	1987-	HU-DNP	HU-DNP
	480	1987-		
	760	1991-	NE-40	NE-40
	762	1991-	NE-40P	NE-40P
	764	1991-	NE-41P	NE-41P
	765	1991-		
	960	1991-1996		
	850	1991-1996	NE-40	NE-40
			NE-40P	NE-40P
AMAZON 140	-1973	NE-13	UN-4	
		NE-56	UN-FP	
			UN-FS	
FH 12	1997	HU-DHP	HU-DHP	
PV AMAZON	-	AS-11	HUD-1	
		AS-24		
WARTBURG	MODELOS	-	DOB-1	DOB-1
			DOB-1D	DOB-1D
			DOB-2	DOB-2
			DOB-2D	DOB-2D
			DOB-3	DOB-3
			DOB-3D	DOB-3D

MARCA BRAND	MODELO MODEL			
YUGO-ZASTAVA	101	1971-1982	FO-FR	IMS-3
	311	1971-1982	FO-FRP	IMS-3P
	411	1971-1982		IMS-5
	413	1971-1982		IMS-5P
	511	1971-1982		
	513	1971-1982		
	KORAL	1987-	FI-6I	FI-3D
	YUGO 45	1987-	FI-6IP3	FI-3DP
	YUGO 55	1987-		FI-3DP5
	YUGO 65	1987-		
	YUGO 45	1982-1984	FI-6I	FI-6I
	YUGO 55	1982-1984	FI-6IP3	FI-6IP3
			FO-E-TC	IMS-3
			FO-E-TCP	IMS-3P
			FO-FR	IMS-5
			FO-FRP	IMS-5P
				SIP-1
	YUGO 45	1985-1986	FI-6I	YU-1D
	YUGO 55	1985-1986	FI-6IP3	
	YUGO 65	1985-1986		
YUGO 45	1986-1987	FI-6I	IMS-3	
YUGO 55	1986-1987	FI-6IP3	IMS-3P	
YUGO 65	1986-1987		IMS-5	
			IMS-5P	
ZAZ	966	-	NE-3	VOL-3
	968 A	-	NE-3P	
	968 M	-	NE-3P1	
			NE-3P2	
	TAVRIA	-	NE-3	AF-19
			NE-3P	AF-19P
			NE-3P1	
		NE-3P2		

CAMIÓN

KAMIONA

TRUCKS

CAMION



LKW









THE KEY TO EXCELLENCE
GLOBALLY UNLOCKING MILLIONS OF DOORS DAILY



CAMIÓN

KAMIOIA • TRUCKS • CAMION • LKW

MARCA BRAND	MODELO MODEL			
ASTRA	BM 64.26	-	AF-7I	IMS-3
	BM 64.30	-	AF-7IP	IMS-3P
	BM 64.36	-	AF-8D	IMS-5
	BM 66.30	-	AF-8DP	IMS-5P
	BM 66.36	-	AF-8I	
	BM 201	-	AF-8IP	
	BM 305	-	AF-9D	
			AF-9DP	
			AF-9I	
			AF-9IP	
BEDFORD	CF	-1980	LF-9	UN-1FS
			LF-RO	
			LF-ROP	
			NE-10	
			NE-10P	
	CF	1980-	NE-10	UN-FT
	CF 2 250 D	1980-	NE-10P	WAS-6
	CF 2 350 D	1980-		WAS-6P
	TL 560	-	NE-1	LF-6
	TL 860	-	NE-10	
TL 1260	-	NE-10P		
TM	-	NE-1P		
BROCKWAY	VARIOS	1966-	BS-4D	BS-4D
			YA-8D	YA-8D
			YA-8I	YA-8I
DAF	2800	-	CHR-3	FO-OA
	3600	-	CHR-3P	
	FA 2100 DT	-		
	FA 2105	-		
	FA 2505	-		
	FA 2805	-		
	FA 3605	-		
	FAS 3605	-		
	FAT 2826	-		
	FAT 3626	-		
	FT 2505	-		
	FT 2805	-		
	FT 3605	-		
	FTT 2826	-		
	FTT 3626	-		
	2800 T. IN.	-1984	NE-3	FO-OA
	FA 1100	1980-1982	NE-3P	
	FA 1300 T	1980-1982	NE-3P1	
	FA 2100	1980-1982	NE-3P2	
	FA 2500	1980-1982		
	F 1100	1985-1991	CHR-3	FO-OA
	F 1300	1985-1991	NE-22P2	
	F 1700	1985-1991		



MARCA BRAND	MODELO MODEL			
DAF	F 1900	1985-1991		
	F 2100	1985-1991		
	F 2500	1985-1991		
	F 3626	1985-1991		
	FA 1100 DT	-	DAV-1	RO-4D
	FA 1300 DNT	-	DAV-1P	RO-4I
	FA 1300 DT	-		
	FA 2100	1982-1984		
	FA 2500	1982-1984		
	FA 2500	-	CHR-3	FO-OA
			CHR-3P	
			NE-3	
			NE-3P	
			NE-3P1	
			NE-3P2	
	F-FA-V- 600	1985-1991	NE-11	FO-OA
	F-FA-V- 800	1985-1991	NE-11P	
	F-FA-V-1000	1985-1991		
	FT 75.270R	-	CHR-3	VO-VB
	FT 85.360W	-	NE-22P	VO-VBP
	FT 3300	-		
	SERIE FT	1991-	CHR-3	VO-VB
			CHR-3P	VO-VBP
V 400	1991-	NE-11	NE-11	
V 600	1991-	NE-11P	NE-11P	
DIAMOND REO	VARIOS	1960-	HUD-1	HUD-1
FIAT IVECO	30.8	-1991	FI-11	FI-11
	35.10	-1991	FI-11P	FI-11P
	35.8	-1991	FI-1P	FI-1P
	40.10	-1991		
	49.10	-1991		
	30.8	1992-	FI-12	FI-11
	35.10	1992-	FI-12P1	FI-11P
	35.12	1992-		
	35.8	1992-		
	40.10	1992-		
	40 NC 35	-	AF-9D	AF-5D
	40.8 F 8	-	AF-9DP	AF-5I
			AF-9I	AF-6D
			AF-9IP	AF-6I
	50 NC	-	AF-9D	IMS-3
55	-	AF-9DP	IMS-3P	
55 NC	-	AF-9I	IMS-5	
80 NC	1979-	AF-9IP	IMS-5P	
		FEM-1D		
		FEM-1I		
50.10 F 10	1979-	LF-RO	IMS-3	
55.8 F 8	1979-	LF-ROP	IMS-3P	
60.10 F 10	1979-	SIP-1	IMS-5	



MARCA BRAND	MODELO MODEL				
FIAT IVECO	65.10 F 10	1979-		IMS-5P	
	70.10 F 10	1979-			
	79.10 F 10	1979-			
	79.13 F 13	1979-			
	79.14 F 14	1979-			
	80.13 F 13	1979-			
	95.14 F 14	1979-			
	100	1979-			
	50.9	-1994	FI-6I	IMS-3	
	60.11	-1994	FI-6IP1	IMS-3P	
	65.12	-1994	FI-9I	IMS-5	
	79.14	-1994	FI-9IP	IMS-5P	
	80.14	-1994			
	95.14	-1994			
	109.14	-1994			
	110.17	-1994			
	100	1981-	AF-8D	IMS-3	
	110	1981-	AF-8DP	IMS-3P	
	110 NC	1981-	AF-8I	IMS-5	
	110 P	1981-	AF-8IP	IMS-5P	
	130	1981-	AF-9D		
	150.20	1981-	AF-9DP		
	160 NC	1981-	AF-9I		
	170 NC 35	1981-	AF-9IP		
			FEM-1D		
			FEM-1I		
	115.17 D T.	-1989	FI-6I	FI-6I	
	115.17 H	-1989	FI-6IP	FI-6IP	
	135	-1989			
	145.17 H T.	-1989			
	175.24	-1989			
	150 R.20	-	AF-9D	FI-5D	
	150 T.20	-	AF-9DP	FI-5I	
	159.20	-	AF-9I	IMS-3	
	190	-1989	AF-9IP	IMS-3P	
	190 T.30	-1989		IMS-5	
	190.26	-1989		IMS-5P	
	180	-1989	AF-7I	IMS-3	
	180.26	-1989	AF-7IP	IMS-3P	
	180.26 T	-1989	AF-9D	IMS-5	
	190.38	-1989	AF-9DP	IMS-5P	
	190.38 T	-1989	AF-9I		
	190.F 35	-1989	AF-9IP		
	190.H 35	-1989			
	190 PC 26	-	BH-2	PRE-1I	
260	-				
190 TURBOS.	1989-1991	AU-1	FI-11		
		AU-HV	FI-11P		
		AU-HVP			
190.26	-1991	FI-11	NE-1		
190.30	-1991	FI-11P	NE-1P		
190.32	-1991				
190.36	-1991				
190.42	-1991				



MARCA BRAND	MODELO MODEL				
FIAT IVECO	190.48	-1991			
	240.26	-1991			
	240.32	-1991			
	240.36	-1991			
	280.36	-1991			
	330.30	-1991			
	330.35	-1991			
	330.36	-1991			
	190.26	1992-	FI-11	FI-11	
	190.30	1992-	FI-11P	FI-11P	
	190.32	1992-			
	190.36	1992-			
	190.42	1992-			
	190.48	1992-			
	240.26	1992-			
	240.32	1992-			
	240.36	1992-			
	280.36	1992-			
	330.30	1992-			
	330.35	1992-			
	330.36	1992-			
	190.30	-1989	AF-7I	FI-5D	
			AF-7IP	FI-5I	
			AF-9D	IMS-3	
			AF-9DP	IMS-3P	
			AF-9I	IMS-5	
			AF-9IP	IMS-5P	
	190.33 T.S.	-1988	VO-VB	FI-11	
	190.38 T.S.	-1988	VO-VBP	FI-11P	
	190.42 T.S.	-1988			
	242 E-15	1985-	FI-3D	IMS-3	
	242 E-18	1985-	FI-3DP3	IMS-3P	
				IMS-5	
				IMS-5P	
	242.15	-1984	CT-1	IMS-3	
	242.18	-1984	CT-1P	IMS-3P	
			CT-3	IMS-5	
			CT-3P	IMS-5P	
	260.36	1992-	FI-11	VO-VB	
	260.48	1992-	FI-11P	VO-VBP	
	330 F 35	-1988	VO-VB	IMS-3	
	330.26	-1988	VO-VBP	IMS-3P	
	330.30	-1988		IMS-5	
	330.32	-1988		IMS-5P	
	330.35	-1988			
330.36	-1988				
619.3A	-	AF-9D	AF-9D		
619.N	-	AF-9DP	AF-9DP		
642	-	AF-9I	AF-9I		
		AF-9IP	AF-9IP		
643	-	AF-9D	AF-5D		
672	-	AF-9DP	AF-5I		
		FEM-1D	AF-6D		
		FEM-1I	AF-6I		



CAMIÓN

TRUCKS

MARCA BRAND	MODELO MODEL			
FORD	A 0406	-	FO-E-TC	UN-FT
	A 0406 R	-	FO-E-TCP	
	A 0509	-	FO-TX	
	A 0509 P	-	FO-TXP	
	A 0609	-	UN-FT	
	D 710 CUSTOM	-		
	CARGO	1986-1991	NE-11P3	
TRANSCONTIN.	-	LF-6	LAS-R	
			LAS-V	
FORD (USA)	CARGO	1986-	NE-11P3	NE-11P3
	MODELOS	-1973	MAZ-14D	MAZ-14D
	MODELOS	1974-1984	MAZ-1D	MAZ-1D
			MAZ-1I	MAZ-1I
	MODELOS	1986-1987	NE-11	LF-WR
			NE-11P	
	MODELOS	1987-1988	FO-11D	FO-11D
		FO-20D	FO-20D	
MODELOS	1988-1995	NE-11	NE-11	
		NE-11P	NE-11P	
MODELOS	1996-1997	FO-15D	FO-15D	
		FO-15DP	FO-15DP	
FREIGHTLINER	VARIOS	-	BS-4D	BS-4D
			HUD-1	HUD-1
			YA-8D	YA-8D
GM (CHEVRO-LET)	MODELOS	1972-1980	TOYO-2	TOYO-2
	MODELOS	1981-1982	MIT-1I	MIT-1I
			MIT-1IP	MIT-1IP
			MIT-2I	MIT-2I
		MIT-2IP	MIT-2IP	
GM (GMC)	MEDIUM	1984-1986	DAT-6D	DAT-6D
	TRUCK W4	1984-1986	DAT-6DP1	DAT-6DP1
	MEDIUM	1986-	ISU-2	ISU-2
	TILTMASER	1986-		
TRUCK W4	1986-			
HINO	MODELOS	1976-	TOYO-K1	TOYO-K1
			TOYO-K1P	TOYO-K1P
ISUZU	NKR	-	MIT-15P	MIT-15P
	NPR	-		
	NQR	-		
	TILTMASER	1986-1988	DAT-6D	DAT-6D
	W4-W5 (S.N)	1986-1988	DAT-6DP1	DAT-6DP1
		ISU-1	ISU-1	
		ISU-2	ISU-2	
KENWORTH	MIDRANGER	1988-	NE-11	NE-11
			NE-11P	NE-11P
MACK	MIDLINER	1982-	BH-1	RO-4I
			BH-1P	
			DAV-1	
			DAV-1P	
	MODELOS	1955-1986	BS-1I	BS-1I
		YA-11D	YA-11D	
MAGIRUS DEUTZ	90 M 5.3	-	BH-1	RO-4D
	90 M 6.0	-	BH-1P	RO-4I
	90 M 6.6	-		



MARCA BRAND	MODELO MODEL			
MAGIRUS DEUTZ	90 M 7	-		
	90 M 9	-		
	130 M 11	-		
	130 M 13	-		
	130 M 16	-		
	130 M 9	-		
	160 M 13	-		
260	-	BH-2	PRE-1I	
360 D 18	-			
MAN	6.100 F	-	VO-R	VO-R
	6.90 F	-	VO-RP	VO-RP
	8.136 F	-		
	8.90 F	-		
	9.136	-		
	9.136 F	-		
	9.136 FAE	-		
	9.150 F	-		
	10.136	-		
	10.150 F	-		
	12.170	-	BH-1	HU-MN
	12.192 F-FT	-	BH-1P	HU-MNP
	12.192 FKT	-		
	12.232 FT	-		
	14.192 F	-		
	14.232 FKT	-		
	14.232 FT	-		
	17.232 F	-		
	18.272 FTI	-		
	19.240 F	-		
	19.262 F	-		
	19.321 F-F/2	-		
	19.322 F-FK	-		
19.322 FLT	-			
19.361 F-FT	-			
19.361-T	-			
19.363 F	-			
19.372 FAK	-			
19.422 F-FT	-			
19.462 F	-			
19.502 F-FLT	-			
22.361	-			
24.362	-			
25.372 FNL	-			
25.422 FNL	-			
33.222 DF	-			
33.240	-			
33.281-T	-			
33.292	-			
33.362	-			
33.365	-			
33.372 DF	-			
33.372 DFA	-			
33.422 DF	-			
33.422 DFA	-			



MARCA BRAND	MODELO MODEL			
MAN	40.440	-		
	41.372 VFK	-		
	41.422 VFK	-		
	33.320	-	BH-1	HU-SX
			BH-1P	
MERCEDES (ARGENTINA)	MODELOS	-	ME-9P	ME-9P
	MODELOS	1990	ME-13DP	ME-13DP
			ME-14P	ME-14P
MITSUBISHI	FUSO	-1985	MIT-2I	MIT-2I
			MIT-2IP	MIT-2IP
	FUSO	1985-	MIT-10	MIT-10
			MIT-11D	MIT-11D
			MIT-9	MIT-9
NISSAN	L.35	-1993	DAT-6	DAT-6
	M 115.17	-1993	DAT-6P	DAT-6P
	L.35.08	-1993	CHR-3	DAT-6
			NE-22P	DAT-6P
	L.70.09	-1993	CHR-5	DAT-6
	L.80.14	-1993		DAT-6P
	MODELOS	1980-	DAT-12	DAT-12
		DAT-6	DAT-6	
		DAT-6P	DAT-6P	
PEGASO	360	-	AU-1	CHR-3
			AU-HV	CHR-3P
			AU-HVP	NE-22P1
			VO-HV	
			VO-HVP	
	620	-	CHR-3	VO-VB
			CHR-3P	VO-VBP
	1236	-	CHR-5	IMS-5
				IMS-5P
PIAGGIO	APE CAR	-	AF-9D	FAB-1
	APE CAR P3	-	AF-9DP	
	P 601	-	AF-9I	
			AF-9IP	
			FAB-1	
			FEM-1D	
			FEM-1I	
	APE P 50	-	FEM-1D	
	APE TM P 50	-	FEM-1I	
			NE-6	
			NE-6P	
	APE TM 703	-	AF-9D	FAB-1
	NICA 125	-	AF-9DP	
		AF-9I		
		AF-9IP		
		FAB-1		
RENAULT SAVIEM	B 70.35	-1987	CHR-3	VA-7
	B 70.45	-1987	CHR-3P	
	B 90.35	-1987	LMP-5	
	MASTER P35 D	-1987	LMP-5P1	
	MASTER T30 D	-1987	NE-22P	
	MASTER T35 D	-1987		
	B 70.45	1988-1992	CHR-3	NE-28

MARCA BRAND	MODELO MODEL			
RENAULT SAVIEM	B 80.45	1992-	NE-22P	
	B 90.45	1988-1992		
	B 90.50	1988-1992		
	B 110.150	1992-		
	B 110.35	1992-		
	MASTER T30 D	1987-		
	MASTER T35 D	1987-		
	MASTER TURBO	1987-		
	G 300 G	-1994	DAV-1	LAS-R
	G 330 GV	-1994	DAV-1P	LAS-V
	G 340 TI	-1994	NE-3	
	GR 305	-1994	NE-3P	
	GR 305 TURBO	-1994	NE-3P1	
	R 310	1984	NE-3P2	
	R 360	1984-1985		
	R 360 TURBO	1984		
	GB 119	1986	DAV-1	RO-4D
	GB 231 TURBO	1986	DAV-1P	RO-4I
	GC 231 TURBO	1986		
	GF 231 TURBO	1986		
	GR 231 TURBO	1986		
	JK 50-60	-	BH-1	RO-15
	JK 75-90	-	BH-1P	RO-4D
	JK 110-115	-		RO-4I
	JP 11	-	BH-1	RO-4D
	JP 13	-	BH-1P	RO-4I
	JP 13 TU	-		
	JP 115	-		
M 160.12	-1994	NE-3	VA-10	
M 200.12	-1994	NE-3P		
M 230.12	-1994	NE-3P2		
M 230.13T	-1994			
M 230.16	-1994			
R 350 TI	-1992			
R 365	-1992			
R 380	-1992			
R 385	-1994			
R 420	-1992			
RI 357	-1992			
R 360	1985-1987	NE-3	LAS-R	
R 370	1985-1987	NE-3P	LAS-V	
R 370 T U8 T	1985-1987	NE-3P2		
S 100.06	-1994	NE-3	RO-4I	
S 100.07	-1994	NE-3P		
S 100.08 T.	-1994	NE-3P2		
S 150	-1994			
S 160.08 T	-1994			
S 160.09	-1994			
S 170.13	-1994			
S 170.145	-1994			
SG2/35-40	-	BH-1	LAS-R	
SG3/35-40	-	BH-1P	LAS-V	
SG4/35-40	-			
TRAFFIC	-1987	CHR-3	RO-17	

CAMIÓN

TRUCKS

MARCA BRAND	MODELO MODEL				
RENAULT SAVIEM			CHR-3P NE-22P		
	TRAFFIC	1988-	NE-19 NE-19P	NE-28	
ROVER	LEYLAND ROAD	-	NE-11 NE-11P	LAS-V	
SCANIA	110	-	BH-2	HU-SX	
	111	-	FO-FR		
	140 8V T	-	FO-FRP		
	141	-	WAS-2P		
	411 8V	-			
	112 H	-1987	VO-VB	WIT-1	
	142 H 8V	-1987	VO-VBP		
	P 82	-1987			
	P 92	-1987			
	P 93 H-HL	1988-			
	P 93 ML	1988-			
	P 113 EL	1988-			
	R 112 H	-1987			
	R 113 E-ES	1988-			
	R 113 HL-HS	1988-			
	R 113 M	1988-			
	R 113 MA	1988-			
	R 142 E	-1987			
	R 142 H	-1987			
	R 142 H 8V	-1987			
R 142 M	-1987				
R 143 EL-ES	1988-				
R 143 HL-HS	1988-				
R 143 MA	1988-				
R-144 NA	1996-	HU-2P	HU-2P		
STEYR PUCH	10 S 14	-	VO-VB	AKS-1	
	17 S 18	-	VO-VBP		
	19 S 31	-	NE-25		
	19 S 37	-			
	26 S 31	-			
	32 S 31	-			
TRUCK (USA)	MODELOS	1995	GM-14 GM-14P GM-25 GM-25P	GM-14 GM-14P GM-25 GM-25P	
	VOLKSWAGEN	MODELOS	1981-1984	VO-VB VO-VBP	VO-VB VO-VBP
			1984-	VO-HV VO-HVP VO-VB VO-VBP	VO-HV VO-HVP VO-VB VO-VBP
	VOLVO	F 6	-	NE-12	NE-12
F 7		-	NE-12P	NE-12P	
F 10		-			
F 12 T 6		-			
F 1020 T 6		-	NE-3 NE-3P NE-3P2	NE-12 NE-12P	

MARCA BRAND	MODELO MODEL			
VOLVO	FL 6 INTER.	-	NE-12	RO-4D
	FL 7 INTER.	-	NE-12P	RO-4I
	FL 10 INTER.	-		
	FL 12 INTER.	-		
	FL 611	-	NE-12	
	FL 614	-	NE-12P	
FL 616	-			
MODELOS	-1987	NE-1 NE-1P	NE-1 NE-1P	
WHITE	VARIOS	-1980	BS-4D HUD-1	BS-4D HUD-1
	VARIOS	-1989	BS-2 BS-5	BS-2 BS-5

MOTOCICLETA

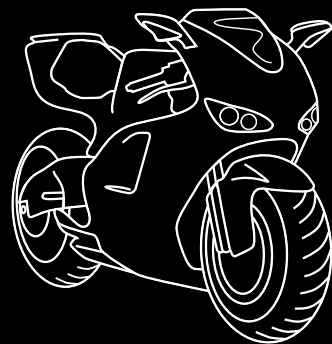

MOTOZIKLETA
MOTORCYCLE
MOTOCYCLETTE
MOTORRAD









THE KEY TO EXCELLENCE
GLOBALLY UNLOCKING MILLIONS OF DOORS DAILY



MOTOCICLETA

MOTOZIKLETA • MOTORCYCLE • MOTOCYCLETTE • MOTORRAD

MARCA BRAND	MODELO MODEL			
APRILIA	AFI 50	1986-1991	ZA-1	ZA-1
	AFI 125	1986-1991	ZA-1P	ZA-1P
	AS 125 R.V.	1986-1991		
	ET 50	1986-1991		
	ETX 125 PV	1986-1991		
	ETX 350	1986-		
	ETX 600	1986-		
	EUROPA 125AE	1992-		
	EXTREMA 125	1993-		
	MX 125 A	1986-1991		
	PEGASO 125	1993-1994		
	RED ROSE 50	1986-1990		
	RED ROSE 125	1986-1990		
	RED ROSE 125	1993-1994		
	RX 125	1992-		
	TUAREG 125	1986-1991		
	AMICO	1996-1998	ZA-6DP1	ZA-6DP1
	AREA 51	1998-2000		
	CLASSIC 50	1996-1999		
	CLASSIC 125	1996-1999		
	ETV 1000 C.	2001-2007		
	GULLIVER	1995-1998		
	LEONARDO	1996-2004		
	MOJITO	1999-2008		
	MOTO 6.5	1996-2002		
	MX	2002-2006		
	PEGASO	1997-2004		
	PEGASO 3-650	1996-		
	RALLY	1996-2004		
	RS	1996-2005		
	RST FUTURA	2000-2003		
	RSV 1000	1998-2005		
	RX 50	1996-2004		
	SCARABEO	1993		
	SL 1000 F.	2000-2003		
	SONIC 50	1998-2008		
	SPORTCITY	2004		
	SR 125-150	1999-2001		
	SR 50	1996-2004		
	AMICO 50	1992-	ZA-4DP	ZA-4DP
	CLIMBER 280	1994-		
	EUROPA 50	1992-		
	EUROPA 125	1994-		
	FUTURA 50	1990-1991		
	FUTURA 50AE	1992-		
	PEGASO 50	1992-		
	PEGASO 125	1994-		
	PEGASO 600	1990-		
	PEGASO 650	1990-		



MARCA BRAND	MODELO MODEL			
APRILIA	RED ROSE 50	1992-		
	RED ROSE 125	1994-		
	RS 50 EXTRE.	1992-		
	RX 50	1992-1996		
	RX 125 EXT.	1994-		
	RX 125 REP.	1994-		
	SIX DAYS RX	1990-1991		
	SR 50	1992-1996		
	TUAREG R. 50	1994-		
	ATLANTIC 125	2003	ZA-9P1	ZA-9P1
	FILO GT 4L	-	AF-8D	
	MX 250	-	AF-8DP	
	RC 250	-	AF-8I	
			AF-8IP	
			FEM-2D	
			FEM-2I	
	FUTURA 50AE	1990-1991	ZA-13P	
	RX 50	1990-1991		
	FUTURA 125	1990-1991	ZA-2P	
	REPLICA 50	1990-1991		
	RALLY 125	1990-1991	ZA-1	NE-8
	RX 125	1990-1991	ZA-1P	
	RED ROSE 50	1990-1991	FI-11	ZA-1
			FI-11P	ZA-1P
			ZA-2P	
	TUAREG 125	1992-	ZA-2P	ZA-2P
	TUAREG 250	1986-	ZA-1	NE-8
	TUAREG 350	1986-	ZA-13P	
	TUAREG 600	1986-	ZA-1P	
ATALA	BYTE AT10-50	1996	ZA-4DP	ZA-4DP
	GREEN	1996		
	HAKER	1996		
BENELLI	124	-	FEM-1D	
	125 TURISMO	-	FEM-1I	
	125 SPORT	1982-1983		NE-8
	125 SPORT	1983-1984	FEM-2D	NE-6
	T 125	-	FEM-2I	NE-6P
	125 SPORT	1984-	FEM-2D	NE-8
	125 TURISMO	1984-	FEM-2I	
	250 2C	-		ZA-1
	304 4C	-		ZA-1P
	354	-		
	654	-		
	750 SEI	-		
	900 SEI	-		
	EXPORT 3V	-		
	G2	-		
	LASER	-		
	MAGNUM 3V	-		



MARCA BRAND	MODELO MODEL			
BENELLI	MOTORELLA 50	-		
	S 50	1985-		
	S 125	-		
BETA	50 CC	-1993	AF-5I	ZA-1 ZA-1P
	ALP	-	ZA-9P1	
	RR	2005		
	CHRONO	1995	ZA-4DP	
	CHRONO 502	1995		
	QUADRA	1995		
	TEMPO	1995		
	KR 50	-	FAB-1	FAB-1
	KR 125	-		
	KR 250	-		
	VRS 50	-		
	QUADRA	1996-	ZA-6DP1	ZA-6DP1
	TEMPO	1996-		
	BICICLETE-CYCLES	MOD.DANES DK	-	
MOD.SUECO S		-		AS-21 AS-21D AS-2D AS-2I
RALEIGH		-		LF-2 UN-FP
BIMOTA	GPI 1	1990-	ZA-1 ZA-1P	ZA-1 ZA-1P
	HB 2	-	NE-6	NE-6
	HB 3	-	NE-6P	NE-6P
	HB 3/S	-		
	KB 1	-	SUZU-13P	NE-6
	KB 2/TT	-	SUZU-4I SUZU-4IP	NE-6P
	SB 2	-	SUZU-13P SUZU-4I SUZU-4IP	
	SB 3	-	SUZU-5	NE-6
	SB 4S	-	SUZU-5P	NE-6P
	SB 4SP	-		
BMA	AMICA 50	-	AF-9D	UN-MRN
	AMICA 125	-	AF-9DP	
	AMICA 250	-	AF-9I	
	AMICA 360	-	AF-9IP FEM-1D FEM-1I	
BMW	400 RS	1984-1985	NE-6 NE-6P	NE-6 NE-6P
	450	1984-1986	NE-7	NE-7
	650	1984-1986		
	K 1	1987-1993		
	K 75	1984-1992		
	K 75 RT	1993-		
	K 75 S	1993-		
	K 100	1984-1992		
	K 100 RS	1993-		



MARCA BRAND	MODELO MODEL			
BMW	K 1100 LT	1993-1994		
	K 1100 RS	1993-1994		
	R 45	1984-1986		
	R 65	1984-1992		
	R 80	1984-		
	R 80 GS	1993-		
	R 80 R	1993-		
	R 80 RT	1993-		
	R 100 GS	1993-		
	R 100 R	1993-		
	R 100 RS	1993-		
	R 100 RT	1993-		
	F 650	1994-	ZA-6DP	
	K 1100	1994-1995	BM-HBP1	BM-HBP1
	K 1100	1995		
	K 1100 LS	1994-		
	K 1100 LT	1994-		
	R 850 RT	1996-2002		
	R 1000	1995		
	R 1100	1994-1995		
	R 1100	1995		
	R 1100 GS	1994-		
	R 1100 R	1994-		
	R 1100 RT	1994-		
	R 60/6	-	NE-7	NE-6
	R 60/7	-		NE-6P
R 75/6	-			
R 75/7	-			
R 80/7	-			
R 90 S	-			
R 90/6	-			
R 100 RS	-			
R 100/7	-			
R 100/S	-			
BUELL	BLAST	2000-2009	ZA-9P1	
	FIREBOLT	2002-2009		
	LIGHTNING	2003-2009		
	ULYSSES	2006-2009		
CAGIVA	125 ALETA	1986-		ZA-1
	200 ELEFANT	1984-		ZA-1P
	350 ALA	1984-1987		
	ALETA EL.125	-		
	COCIS 50	-1991		
	CRESTA 350	1984-1987		
	DG 350	1984-1987		
	RX 250	1984-		
	SST 250 ALA	1984-		
	SST 250 RL	1984-		
	SST 350 RL	1984-1987		
	SX 250	1984-		
	SX 350	1984-1987		
	SXT 250	1984-		
	WMX 250	1984-		
WMX 500	1984-			



MOTOCICLETA

MOTORCYCLE

MARCA BRAND	MODELO MODEL			
CAGIVA	650	-	SUZU-13P	SUZU-13P
			SUZU-4I	SUZU-4I
			SUZU-4IP	SUZU-4IP
	900 ELEFANT	1997	KAW-6P	
ALETA ORO L.	1986-		FI-6I	ZA-1
			FI-6IP2	ZA-1P
			FI-6IP3	
ALETA ROSA	1986-	SUZU-13P	ZA-1	
AR 350	1984-1989	SUZU-4I	ZA-1P	
ELEFA. 2 125	-	SUZU-4IP		
ELEFA. 2 200	-1984			
ELEFA. 2 350	1984-1989			
ELEFA. 2 600	-			
K 3	1991-1992			
SST 125	1984-			
SXT 125 N	1984-			
W 8	1994			
BLUES 125	-	FI-1	FI-1	
FRECCIA 125	-	FI-1P	FI-1P	
FULL FUN 125	-1990			
MITO 125	-1990			
MMX 125	-1990			
TAMANACO 125	-			
CITY	1993-1994	KAW-6P	KAW-6P	
ELEFA. 900	1992-			
MITO	1992-			
MITO 125	1991-1992			
MITO CARENA.	1991-1992			
MITO EV	1994-1995			
MITO LAWSON	1993-			
MITO RACING	1991-1994			
MITO RACING	1994			
PRIMA	1993-			
SUPER CITY	1993-			
CITY	1994-	ZA-8P	ZA-8P	
CITY LUCKY	1994-			
CITY PASSING	1994-			
SUPERCITY	1994-			
ELEFA. 90	-1991	FI-1	ZA-1	
ELEFA. 750	-1991	FI-1P	ZA-1P	
FRECCIA 125	1991-1992			
LUCKY 350 E.	1987-1991			
LUCKY 350 EX	-1991			
N 90	1991-1992			
PARIS DAKAR	-1991			
T 350 E	1987-1991			
T4 350	-1991			
T4 350 R	1987-1991			
T4 500 E	-1991			
HD 175	-	FEM-1D		
HD 350	-	FEM-1I		
RIVER 600 C.	1995-	ZA-4DP		
ROADSTER 125	1994	ZA-1		
		ZA-1P		



MARCA BRAND	MODELO MODEL			
CAGIVA	S.CITY 125	1992-	ZA-4DP	ZA-4DP
	SST-SX 125	-1984	FEM-1D	ZA-1
	SST-SX 250	-1984	FEM-1I	ZA-1P
	SST-SX 350	-1984		
	SXT 125	1984-	SUZU-13P	
			SUZU-4I	
			SUZU-4IP	
	TRIAL 125	-		CL-2I
	TRIAL 350	-		CL-3I
	W 12 350	1994	ZA-1	ZA-1
W 16	1997	ZA-1P	ZA-1P	
CIMATTI	GRINGO G1-4M	-		ZA-1
	GRINGO LUX	-		ZA-1P
DEMME	SMILY	-		NE-6
				NE-6P
DERBY	ATLANTIS 100	2003-	ZA-9P1	ZA-9P1
	MULHACEN	2006-		
	PREDATOR	1999		ZA-9P1
DKM-HERCULES	125 G SPEC.	-		NE-6
	175 GS	-		NE-6P
	250 GS	-		
	505 P	-		
	531	-		
	535 S	-		
DUCATI	125 REG. 2T	-		NE-6
				NE-6P
	250 SCRAMBL.	1982-	FEM-1D	NE-6
	350 GTV	1982-	FEM-1I	NE-6P
	350 SCRAMBL.	1982-	FEM-2D	
	450 SCRAMBL.	1982-	FEM-2I	
	500 2 CIL.	1982-		
	500 GTL	1982-		
	500 SL PANT.	1982-		
	750 GT-SS	1982-		
	750 SPORT	1982-		
	860 GT-GTS	1982-		
	900 2 CIL.	1982-		
	900 REPLICIA	1982-		
	900 SD-SS	1982-		
	350 F3 DESMO	1984-	FEM-1D	NE-8
	350 GTL-XL	1984-	FEM-1I	
	350 SL-TL	1984-	FEM-2D	
	500 GTV-SL	1984-	FEM-2I	
	500 SPORT D.	1984-		
600 SL-TL	1984-			
900 DARMAH	1984-			
350 SPORT	1993-	KAW-6P	KAW-6P	
400 SPORT	1993-			
600 S.SPORT	1994			
750 SS	1991-1992			
851 S	1991-1992			
851 SPORT	1991-1992			
888 RACING	1993-			
888 S.P.4	1991-1992			



MARCA BRAND	MODELO MODEL				
DUCATI	888 S.P.5	1993-			
	900 M	1993-			
	900 S.L.	1991-			
	900 S.S.	1991-1992			
	900 SS	1991-			
	907 i.e.	1991-1992			
	CARENATA	1991-			
	CUPOLINO	1991-			
	600 MONSTER	1994-2001	KAW-6P		
	748	1995-2003			
	750 S.SPORT	1999-2003			
	900 MONSTER	1994-2001			
	900 S.SPORT	1998-2002			
	996	1999-2004			
	ST 2	1997-2003			
	ST4	1998-2003			
	750 F1 DESMO	1986-1991	FEM-1D	NE-8	
			FEM-1I		
			FEM-2D		
			FEM-2I		
			FI-6I		
			FI-6IP3		
	750 F1 DESMO	1987	ZA-13P	ZA-13P	
	851 SPORT	1989-1990			
	907 i.e.	1989-1990			
	DESMO 900 SS	1989-			
	PASO 906	1989-			
	750 INDIANA	1990-1991	FI-6I	FI-6I	
	750 SPORT R	1990-1991	FI-6IP3	FI-6IP3	
	PASO 750 LTD	1990-1991			
	851 S	1990-1991	FI-6I	ZA-1	
	900 S.S.	1990-1991	FI-6IP3	ZA-1P	
907 i.e.	1992	ZA-4DP	ZA-4DP		
INDIANA 350	1987-		ZA-1		
INDIANA 650	1987-		ZA-1P		
INDIANA 750	1987-				
PASO 350	1987-	ZA-13P	ZA-1		
PASO 750	1987-		ZA-13P		
			ZA-1P		
FANTIC MOTOR	50.1 OASIS	1984-1991		ZA-1	
	CABALLERO	1992-		ZA-1P	
	CABALLERO 50	1984-1991			
	CLAN 50	1982-			
	CLUBMAN	1993-			
	ISSIMO	1982-			
	JOY 3V	1984-1991			
	JOY MK	1984-1991			
	JOY VK	1984-1991			
	KOALA	1993-			
	K-ROO	1992-			
	RAIDER 50.1	1984-1991			
	RAIDER 125LC	-			
	RAILLY 240	-			
	TENTER TO	1984-1991			



MARCA BRAND	MODELO MODEL			
FANTIC MOTOR	TRIAL 50	1982-		
	TRIAL 201	-1991		
	TRIAL 240	-1991		
	TRIAL 241	-1991		
	TRIAL 242	-1991		
	TRIAL 245	-1991		
	TRIAL 300	-1991		
	TRIAL 301	-1991		
	TRIAL 303	-1991		
	TRIAL 305	-1991		
	TRIAL KID	1984-1991		
	TRIAL S.5	1984-1991		
	TRIAL S.7	1984-1991		
	125	1984-	ZA-1	ZA-1
	125 SPORT	1984-	ZA-1P	ZA-1P
	ISSIMO 50	1984-		
	RAIDER 50	1984-		
	RAIDER GT 50	1984-		
	SPRINTER 3V	1984-		
	SPRINTER 50	1984-		
	SPRINTER MU.	1984-		
	STRADA 50	1984-		
	STRADA 125	1983-		
	ENDURO 50	1985-		NE-8
	RAIDER 125	-		
	TRIAL 50	1985-		
	TRIALMATIC50	1985-		
	GR.TUR.50 CC	-		NE-6
				NE-6P
	HP1 125	-	FI-6I	FI-6I
			FI-6IP3	FI-6IP3
	LEI 50 CC	-		IMS-5
			IMS-5P	
TRIAL 125	-		NE-8	
TRIAL 200	-		ZA-1	
			ZA-1P	
GARELLI	BASIC 50	1985-		ZA-1
	BASIC2 50	1985-		ZA-1P
	FORMUNO	1988-1991		
	GARY	1992-		
	GARY DUE 50	1988-1991		
	GARY UNO 50	1988-1991		
	SAHEL 50 ES	-1991		
	TEAM 3V 50	-1991		
	TEAM BIMATIC	-1991		
	TEAM MATIC	-1991		
	URKA AC-LC50	-1991		
	VIP N3V 50	-1991		
	CICLONE 50	-1986		AF-19
	CICLONE 5V 5	-1986		AF-19P
	EUREKA FLEX	-		IMS-5
	JUNIOR T 50	1982-1986		IMS-5P
	JUNIOR GT 50	1982-1986		ZA-1
	JUNIOR K1005	-1986		ZA-1P



MOTOCICLETA

MOTORCYCLE

MARCA BRAND	MODELO MODEL			
GARELLI	NOI 50	-1986		
	VIP 1-N50	-		
	VIP 2-N50	-		
	VIP 3-N50	-		
	VIP 4-N50	-		
	CICLONE 5VN	1986-1988	ZA-1	ZA-1
	CICLONE LC	1986-1988	ZA-1P	ZA-1P
	NOI BIMATIC	1987-1991		
	NOI MATIC	1987-1991		
	NOI TL 50	1987-1991		
	GRAN TURISMO	-		NE-6 NE-6P
	GTA 125	-	FI-6I FI-6IP3	FI-6I FI-6IP3
	SUPER VIP	1985-1989	AF-6D	ZA-1
	TIGER 125XLE	-		ZA-1P
	TRS 125 S.M.	-		
XR 125 TIGER	-			
TIGER XRD	-	ZA-1 ZA-1P		
GILERA	50 GSA LUS	-	AF-6D	NE-8
	50 TS-GSA	-		
	50 R1	-		ZA-2P
	50 RALLY	-		
	50 RC TRO.	-		
	50 TREND	-		
	50 SIOUX A	-	ZA-4DP	ZA-4DP
	125 APACHE	1991-		
	125 CROMO	1991-		
	125 FREE ST	-		
	125 GFR S.P.	-		
	125 SIOUX	-		
	350 NORDWES	1993-		
	600 NORD WE	-		
	600 R	1993-		
	600 RC	1991-		
	RC 750 R	-		
	TYPHOON	-1995		
	125 CX AE	-	ZA-1	ZA-1
	125 GRF	1993-	ZA-1P	ZA-1P
	125 R	1993-		
	503 AE	1993-		
	ARIZONA 125	-		
	ARIZONA 250	-		
	BULLIT AE	1992		
	BULLIT KICK	1992		
	BULLIT MIX	1993-		
	RC 600 R	1991-		
	RTX 125-200	-		
	RV 125-200	-		
RX 125-200	-			
SIOUX AE	1993-			
125 GR1-TG1	-		NE-6	
150	-		NE-6P	



MARCA BRAND	MODELO MODEL				
GILERA	ECO 50	-			
	125 MRX	-1991	FI-1	FI-1	
	125 RC	-1991	FI-1P	FI-1P	
	125 SPO1	-1991			
	125 SPO2	-1991			
	125 XR2 R.	-1991			
	125 TG2	-	AF-6D	ZA-1 ZA-1P	
	200 T 4	-	AF-9D		
	200 T45	-	AF-9DP		
	CUSTOM 125	-	AF-9I		
	CUSTOM 200	-	AF-9IP	FEM-1D FEM-1I	
	250 NGR	-	FI-6I FI-6IP3	FI-6I FI-6IP3	
	350 DAKOTA	-1990	FI-6I	FI-6I	
	500 DAKOTA	-1990	FI-6IP3	FI-6IP3	
	500 SATURNO	-1990	ZA-2P	ZA-2P	
	600 RC	-1990			
	CBA 50	-1991		ZA-1 ZA-1P	
	NCR 50	2006-	ZA-9P1	ZA-9P1	
	NEXUS	2006-			
	RUNNER	2006-			
	STORM 50	1995	ZA-7DP		
	TYPHOON	1995-			
	HARLEY DAVIDSON	883 SPORT.	1994	HD-4D	HD-4D
		1200 SPORT.	1994		
		FLH 1340 EL	-	HD-1	NE-6
FLHC 1340 EL		-	HD-1D	NE-6P	
FLHC 1340 S.		-	HD-2	NE-8	
FLT 1340 TO.		-	HD-2D		
FLTC 1340 TO		-	HD-3		
FXB 1340 ST.		-	HD-3D		
FXE 1340 SU.		-			
FXPS 1340 SU		-			
FXR 1340 SU.		-			
FXS 1340 LOW		-			
FXWG 1340 WI		-			
XLH 1000 SP		-			
XLS 1000 RO		-			
VARIOS	-1960	BS-6			
VARIOS	1996	CHI-1T	CHI-1T		
HERCULES	K 125	-	YAMA-21I YAMA-21IP		
HM	LOCUSTA	-	ZA-9P1		
HONDA	125	1980-	SUZU-13P	NE-6	
	125 E	1980-1982	SUZU-4I	NE-6P	
	125 S	1980-	SUZU-4IP		
	125 SILHO.	1980-			
	CB 125 T2	1982-			



MARCA BRAND	MODELO MODEL				
HONDA	125 E	1982-	SUZU-13P SUZU-4I SUZU-4IP	NE-8	
	125 LEAD	1991	HOND-4I	HOND-4I	
	600 VT.R.	1990-	HOND-4IP1	HOND-4IP1	
	CBR 600 F	1987-			
	CBR 1000	1991-1992			
	VF 750 C	1990-			
	VFR 750 FK	1990-1991			
	VFR 750 FL	1990-1991			
	VFR 750 P.	1990-1991			
	VFR 750 R	1990-1991			
	XRV 750 A.	1992-			
	125 VISION	-	SUZU-13DP SUZU-4D SUZU-4DP	SUZU-13DP SUZU-4D SUZU-4DP	
	200 R	-1989	HOND-19	HOND-19	
	CB 650	1984-	HOND-19D	HOND-19D	
	CB 750	1986-1991	HOND-19DP	HOND-19DP	
	CB 900	1984-	HOND-19P	HOND-19P	
	CB 1100	-1993	HOND-4D	HOND-4D	
	CBX 500	1984-1987	HOND-4DP	HOND-4DP	
	CBX 550	1984	HOND-4DP2	HOND-4DP2	
	CBX 650	1984-	HOND-4I	HOND-4I	
	CBX 750	1986-1991	HOND-4IP	HOND-4IP	
	CR 500	1984-1987			
	CX 650	1984-			
	FT 500	1984-1987			
	GL 650	1984-			
	GL 1100	-1991			
	NS 400	1986-			
	VF 500	1984-1987			
	VF 750	1986-1991			
	VF 1000	-1991			
	VF 1100	-1991			
	VRF 750	1986-1991			
	VT 500	1984-1987			
	XLV 750	1986-1991			
	YT 1100	-1991			
	350 FOUR	1979-1981	HOND-7I	NE-6	
	500 FOUR	1979-		NE-6P	
	350 FOUR	1981-	HOND-4D	NE-6	
	400 FOUR	1981-1982	HOND-4DP	NE-6P	
	CB 400 N	1979-1981	HOND-4DP2		
	CB 400 N	1981-1982			
	CB 750 K	1980-			
	CM 400 T	1981-1982			
	CX 500	1981-1982			
	400 CBF	1979-	HOND-3I	NE-6	
500 CBT	-		NE-6P		
500 FOUR	1976-1979	HOND-49	NE-6 NE-6P		
500 FOUR K	1979-	HOND-4D			
1100 GOLD W.	-	HOND-4DP			



MARCA BRAND	MODELO MODEL			
HONDA	CB 650	-	HOND-4DP2	
	CB 750 F.	1980-		
	CB 750 FI	1981-		
	CX 500	1979-1981		
	500 R	1983-	VO-VBP1	VO-VBP1
	600 R	1983-		
	1200 G.W.	-1991		
	GL 1200	-1991		
	GL 1500	-1991		
	GX 1200 DL	-1991		
	VF 750 C	1982-1990		
	VF 750 CU.	1982-		
	VF 750 S	1982-		
	XL 350 R	1986-1991		
	XL 350 RF	1986-1991		
	500 R CROSS	1982-	HOND-4D	NE-8
	CB 250 N	1986-	HOND-4DP	
	CB 250 RS	1986-	HOND-4DP2	
	CB 750 C	1979-		
	CB 750 K	1979-1980		
	CB 900 B.	1982-		
	CB 900 F	1982-		
	CB 900 FI	1982-		
	CB 1100 R	-		
	CBR 250 F	1986-		
	CBX 400 F	1982-		
	CBX 400 FC	1984-		
	CBX 400 FI	1984-		
	CDI 125 6	1984-1986		
	FT 500	1983-1984		
	RAVEL 250	1986-		
	REBEL 250	1986-		
	XL 500 R	1982-1984		
	XL 500 S	1982-		
	XR 500 R	1982-1984		
	600 PROA.	1985-1991	HOND-4D	HOND-4D
	600 VTR.	1985-1991	HOND-4DP	HOND-4DP
	CB 450	1986-	HOND-4DP2	HOND-4DP2
	CBX 1000 S.S	-	HOND-4I	HOND-4I
	CX 500	1984	HOND-4IP	HOND-4IP
	MTX 200 R	-1989		
	NTV 650	1984-1992		
	ST 1100	-1991		
	TRX 200 SX	-1989		
	VF 400 F	1986-		
VFR 400 R	1986-			
XL 200	-1989			
XL 200 PD	-1989			
XL 500 R	1984-			
XL 600	-1984			
XL 600	1985-1991			
XL 600 LM	1985-1991			
XL 600 R	1985-1991			
XL 600 RM	1985-1991			



MOTOCICLETA

MOTORCYCLE

MARCA BRAND	MODELO MODEL			
HONDA	XL 600 RX	1985-1991		
	XR 500 R	1984-		
	600 V.T.	1992-	HOND-4D	HOND-4D
	CB 750	1992-	HOND-4DP1	HOND-4DP1
	NTV 650	1992-1996	HOND-4DP2	HOND-4DP2
	NX 650 D	1983-		
	VFR 750	1986-1989		
	VT 600	1989-		
	650 G.W.	1983-1991	HOND-4D	HOND-4D
	ASPENCADE	-1991	HOND-4DP	HOND-4DP
	CB 250 N	1982-1985	HOND-4DP2	HOND-4DP2
	CB 250 RS	1982-1985		
	CB 400 L	1985-		
	CB 400 N	1982-		
	CB 550	1982-		
	CBR 1000	-1991		
	CBX 125	1984-	HOND-4DP1	HOND-4DP1
	CBX 1100 6C.	-	HOND-4DP2	HOND-4DP2
	CL 250 N	1982-1985	HOND-4D	
	CL 250 S	1982-1985	HOND-4DP	
	CM 250 C	1982-1985	HOND-4DP2	
	CX 500	1982-1984	HOND-4I	
	ENTERSTAT	-1991	HOND-4IP	
	G.WING 1.2	-1991	HOND-4I	HOND-4I
	GL 500	1982-	HOND-4IP	HOND-4IP
	ST 1100 PE	1991-		
	VT 500	1983-1984		
	X 400 R	1986-		
	XL 125 P.D	1984-1986		
	XL 125 P3	1990-		
	XL 125 PD	1984-1986		
	XL 125 R	1984-1986		
	XL 125 R3	1990-		
	XL 125 SD	1984-1986		
	XL 200 P3	1989-1991		
	XL 200 PD	1989-1991		
	XL 200 R	1989-1991		
	XL 200 R2	1989-1991		
	750 AFRICA	1991	HOND-19	HOND-19
			HOND-19D	HOND-19D
			HOND-19DP	HOND-19DP
			HOND-19P	HOND-19P
			HOND-4D	HOND-4D
			HOND-4DP1	HOND-4DP1
			HOND-4DP2	HOND-4DP2
750 FOUR	1979-	HOND-4D		
		HOND-4DP		
		HOND-4DP2		
		HOND-4I		
		HOND-4IP		
750 RXLV	1985-	HOND-4I	HOND-4I	
750 XLV	1985-	HOND-4IP	HOND-4IP	
CB 125 T	1986-			
CN 250	-1991			



MARCA BRAND	MODELO MODEL			
HONDA	MTX 125 R	1986-		
	NX 125	1990-		
	NXR 650 A.	1988-1990		
	PC 800	1989-1991		
	SPACY SCOOT.	-		
	XL 250 R	-1991		
	BIG RED 125	1986-	HOND-19	HOND-19
	CB 450	1986	HOND-19D	HOND-19D
	CBR 1000	1992	HOND-19DP	HOND-19DP
	CN 250	1991-1994	HOND-19P	HOND-19P
	CRM 125	1990-1992	HOND-4I	NE-6
	CX 500	1984-1987	HOND-4IP	NE-6P
	MTX 200	-1989		NE-8
	NH 125 PEAD	1986-	HOND-4I	NE-6
	NTV 650	1984-1994	HOND-4IP	NE-6P
	NX 650	1991-1994		
	PK 50 DX WA.	1992	HOND-4D	HOND-4D
	SA 50 M VIS.	1992	HOND-4DP1	HOND-4DP1
	SPACY	-	HOND-4DP2	HOND-4DP2
	ST 1100	1992	HOND-4I	HOND-4I
	TRX 200	-1989	HOND-4IP1	HOND-4IP1
	VF 400	1986		
	VFR 400	1986		
	VFR 750	1991		
	XL 125	1984-1986	HOND-24P	HOND-24P
	XL 125	1990-		
	XL 200	1990-1991		
	XL 250	-1991		
	XL 500	1984-		
	XL 600	1984-1985		
	XR 500	1984-		
	CAMINO S 50	-		NE-8
	CBX 900 FII	-		
	CB 125 S	1979-	HOND-4D	NE-6
			HOND-4DP	NE-6P
			HOND-4DP2	
			HOND-4I	
			HOND-4IP	
	CB 125 SI.	1982-	HOND-4I	NE-6
	XL 125	1982-1983	HOND-4IP	NE-6P
				NE-8
	CB 125 X	1982-	HOND-4I	NE-6
	CBX 125	1982-1983	HOND-4IP	NE-6P
	CS 125	1982-		
	CB 500	1994-1997	HOND-4D	HOND-4D
CB 1000	1993-	HOND-4DP1	HOND-4DP1	
CBR 900 RR	1994-1996	HOND-4DP2	HOND-4DP2	
CBR 1000	1992-	HOND-4I	HOND-4I	
CRM 125	1990	HOND-4IP1	HOND-4IP1	
NSR 125 F	1990-			
NSR 125 R	1990-			
NSR 125 R SP	1990-			
CB 500S	1997-	HOND-24P	HOND-24P	
CBF 500	2004-			



MARCA BRAND	MODELO MODEL				
HONDA	CBF 600	2004-			
	CBR 900 RR	1997			
	CBR 1000 F	1997			
	FORZA	2005-			
	NTV 650	1997-1998			
	NX 650	1997-			
	SFX 50	1997-			
	SH 50	1997-			
	SH 100	1997-			
	SJ 100 BALI	1997-			
	ST 1100	1997-			
	CB 550 F	1979-1982		NE-6	NE-6P
	CB 650 CUST	-	HOND-4D	NE-8	
	CB 650 SC	-	HOND-4DP1		
			HOND-4DP2		
	CB 750 F	1979-	HOND-7D	NE-6	
			HOND-7I	NE-6P	
	CB 750 FO.	1978-	HOND-7I		
	CBX 125	1983-1984	SUZU-13P	NE-6	
	MH 125	1983-	SUZU-4I	NE-6P	
	XL 125	1983-1984	SUZU-4IP	NE-8	
	CBX 900	1984-	HOND-19		
			HOND-19D		
			HOND-19DP		
			HOND-19P		
	CG 125	1993-2008	HOND-26DP1	HOND-26DP1	
	ECONO POW.90	1993-	HOND-26P1	HOND-26P1	
	CMX 450 SC.	-1991	SUZU-13P	SUZU-13P	
			SUZU-4I	SUZU-4I	
			SUZU-4IP	SUZU-4IP	
	CR 250	-1991	HOND-19	HOND-19	
			HOND-19D	HOND-19D	
		HOND-19DP	HOND-19DP		
		HOND-19P	HOND-19P		
		HOND-4I	HOND-4I		
		HOND-4IP	HOND-4IP		
DYLAN 125	2004-	ZA-9P1	ZA-9P1		
PHANTEON 150	2003-				
PS 125I	2006-				
PS 150I	2006-				
SH 125I	2005-				
SH 150I	2006-				
HORNET	1998	HOND-43	HOND-43		
		HOND-43D	HOND-43D		
		HOND-43DP	HOND-43DP		
		HOND-43P	HOND-43P		
LEAD 100	2003-	HOND-28P			
MTX 125	1990-1992	HOND-19	HOND-19		
MX 125	1990-1992	HOND-19D	HOND-19D		
		HOND-19DP	HOND-19DP		
		HOND-19P	HOND-19P		
		HOND-4D	HOND-4D		
		HOND-4DP1	HOND-4DP1		



MARCA BRAND	MODELO MODEL			
HONDA			HOND-4DP2	HOND-4DP2
			HOND-4I	HOND-4I
			HOND-4IP1	HOND-4IP1
	NH 50	-1991	AF-6D	NE-8
	PA 50 DLX	-1991		
	PK 50 DX	-1991		
	PX 50 S	-1991		
	SA 50	-1991		
	PK 50	1993-	HOND-25P2	HOND-25P2
	SA 50 P	1993-	HOND-4I	HOND-4I
	SH 50	1993-1996	HOND-4IP1	HOND-4IP1
	SFX 50	1994-1995	HOND-20	
	SJ 50 BALI	1994-1995	HOND-20D	
			HOND-20DP	
			HOND-20P	
	SH 50	1991-1993	VO-VBP1	HOND-30DP2
				HOND-30P2
				VO-VBP1
	VFR 750	1989-1991	HOND-20	HOND-20
			HOND-20D	HOND-20D
		HOND-20DP	HOND-20DP	
		HOND-20P	HOND-20P	
VRF 750	1989-1991	HOND-28DP	HOND-28DP	
		HOND-28P	HOND-28P	
ITALJET	ASCOT	1992-	YAMA-27	YAMA-27
	BAZOOKA	1992-	YAMA-27D	YAMA-27D
	TIFFANY	1992-	YAMA-27DP	YAMA-27DP
			YAMA-27P	YAMA-27P
	DRAGSTER	1998	ZA-9P	ZA-9P
	FORMULA 50	1996-	ZA-4DP	
	PISTA	1994	YAMA-27DP	YAMA-27DP
	SCOOP	1994	YAMA-27P	YAMA-27P
KAWASAKI	400 CUSTOM	1991-	KAW-6P	KAW-6P
	750 CUSTOM	1991-		
	EN 500	1993-		
	KLX 650	-		
	TWIN CAM	1992		
	VN 1500 SUMO	-		
	VN 1600	2003-		
	ZXR 400	1991-		
	ZXR 1100	1991-		
	ZZR 250	-		
	ZZR 600	-		
	ZZR 1100	1991-1992		
	400 GT	1980-1985	KAW-8	KAW-8
	400 KZ	1980-1985		
	400 Z	1980-1985		
	400 ZB	1980-1985		
	550 LTD	1982-	KAW-3	KAW-3
	GPZ 250	-		
	GPZ 305	-		
	GPZ 450	-		
	GPZ 550	1982-1984		
	GPZ 600 R	-		



MOTOCICLETA

MOTORCYCLE

MARCA BRAND	MODELO MODEL			
KAWASAKI	GPZ 750	-		
	GPZ 750 R	-		
	GPZ 900 R	-		
	GPZ 1000	-		
	GPZ 1100	-		
	GPZ 1300	-		
	KL 250	-		
	KLR 250	-		
	VOYAGER	-		
	Z 250 C	-		
	Z 250 GP	-		
	Z 250 LTD	-		
	Z 305	-		
	Z 450	-		
	Z 550	1982-1984		
	Z 600	-		
	Z 750	-		
	Z 750 LTD	-		
	Z 750 TURBO	-		
	Z 900	-		
	Z 1000	-		
	Z 1100	-		
	Z 1300	-		
	900 Z1	-	KAW-4	KAW-4
	1000 GTR	1984-1991	KAW-3	KAW-5
	1300 Z	1986-1991	KAW-5	KAW-5P
	CS 250	1984-1986	KAW-5P	
	FX 400 R	1984-		
	GPZ 305	1984-		
	GPZ 550	1984-1990		
	GPZ 750	1984-1991		
	GPZ 900 R	-1986		
	GPZ 1000	1984-1991		
	GPZ 1100	1984-		
	GT 750	1984-1991		
	GTR 1000	1984-1991		
	KL 250	1984-1986		
	KLR 570	1984-1990		
	KLR 650	1980-1991		
	LTD 450	1984-		
	SR 650	1980-1991		
	TENGAI 650	1980-1991	KAW-5	KAW-5
	VN 750 T.	1984-1991	KAW-5P	KAW-5P
	Z 250	1984-		
	Z 305 B.	1984-		
	Z 400	1984-		
	Z 440	1984-		
	Z 550	1984-1990		
	Z 750	1985-1992		
	Z 1000 RZ	1984-1991		
Z 1100	1984-			
Z 1300	1986-1991			
ZN 1300 V	1986-1991			
ZR 550	1984-1990			



MARCA BRAND	MODELO MODEL			
KAWASAKI	ZX 550	1984-1990		
	ZX 1000	1984-1991		
	ZXR 750	1985-1992		
	AR 125	-1986		NE-6
	KDX 175	-		NE-6P
	KE 125	-1986		
	KE 175	-		
	KMX 125	-1986		
	KX 125	-1986		
	EJ 650	1999-2006		
	EJ 800	2011		
	KLR 250	1997-2010		
	KLX 125	2010-2011		
	KLX 250	1999		
	NINJA 250R	1990-2007		
	NINJA 500R	1993-1994		
	NINJA 600R	1990-1996		
	NINJA ZX- 6R	1993-2006		
	NINJA ZX-11R	1993-2001		
	VN 250	2000		
	VN 400	1999-2000		
	VN 1500	1987-2001		
	VN 1700	2009		
	VN 2000	2004-2010		
	Z 500	1991-1998		
	Z 750	1992-1997		
	Z 1000	2003-2005		
	ZG 1000 CON.	1992-2006		
	ZRX 1100	1992-2000		
	ZRX 1100	2001-2006		
	ZRX 1200	2001-2006		
	EN 500	-1991	KAW-2I	KAW-2I
	KLR 250	1985-1986		
	ER 5	2003-	KAW-9P	KAW-9P
	NINJA ZX- 6R	2003-		
	NINJA ZX- 7R	2003-		
	NINJA ZX- 9R	2003-		
	NINJA ZX-12R	2003-		
	Z 750	2004-		
	ZR 7	1999-		
	ZZR 1200	2003-		
	GLX 1100	1993-	KAW-5	KAW-5
	GPX 600	1986-1990	KAW-5P	KAW-5P
	GPZ 500	1987-		
	GPZ 500 S	1994		
	GPZ 600	1986-1990		
	KDX 250 D	-		
	KL 250	1986-		
	KLE 500	1994		
	KLR 250	1986-1996		
KX 250	1986-			
LTD 450 C.	1986-			
SJ 50 BALI	1994			
Z 650	1983			



MARCA BRAND	MODELO MODEL			
KAWASAKI	ZL 600	1990-1992		
	ZZR 600	1990-1992		
	GPZ 400	-	KAW-3	KAW-3
	GPZ 550	-	KAW-4	KAW-4
	LTD 450	-	SUZU-13P	
	Z 400	-	SUZU-4I	
	Z 400 TW.	-	SUZU-4IP	
	Z 440 LTD	-		
	Z 550 LTD	-		
	GPZ 750	-1984	KAW-3	
	Z 400 F	1981-1982		
	Z 400 J	1981-1982		
	Z 500	1981-1991		
	Z 750	1984-1985		
	KH 400	1978-	KAW-4	
	OH 400	1978-	SUZU-13DP	
	Z 400	1978-1981	SUZU-13P	
			SUZU-4D	
			SUZU-4DP	
			SUZU-4I	
			SUZU-4IP	
	KL 600 S	1986-1991	KAW-2D	KAW-2D
	KLR 600	1986-1991	KAW-2I	KAW-2I
	KLR 600	-	KAW-1D	KAW-1D
	Z 440	-	KAW-1I	KAW-1I
	Z 650 F	1984-1991		
	Z 650 S	1984-1991		
	Z 650 SR	1984-1991		
	KLR 600 S	1994-1995	KAW-7P	KAW-7P
	KLR 650	1994-1995		
	NINJA ZX- 9R	1994-1995		
	ZXR 750	1993-1994		
	ZZR 600	1994-1995		
	ZZR 1100	1993-1994		
	KL 1000	2004-	SUZU-12DP	SUZU-12DP
	LDT 500	1995	KAW-6DP	KAW-6DP
	VN 800	1995		
	NINJA 250R	2011	KAW-10P	KAW-10P
	Z 250 A	1982-	KAW-2I	
	Z 250 C	1982-	KAW-8	
	Z 250 J	1982-	KAW-8D	
	Z 400	1978-1980	KAW-8	
Z 400	1981			
Z 400	1981-1984	KAW-2I		
Z 440 H	1982-	KAW-2D		
Z 440 J	1982-	KAW-2I		
Z 440 LTD	1982-			
ZL 600 ELI.	1997	KAW-5		
		KAW-5P		
ZXR 400	1990-1991	KAW-2D	KAW-2D	
ZXR 1100	1990-1991			
ZZR 1100	1990-1991			
KTM	ER 5	2003-	ZA-9P1	ZA-9P1
	MODELOS	1988-	VO-VBP1	VO-VBP1



MARCA BRAND	MODELO MODEL				
KYMCO	GRANDINK	2001			
	CX 50	1997	HOND-4I	HOND-4I	
	K 1250	1997	HOND-4IP	HOND-4IP	
	KB 50	1997			
	SNIPER 50 DD	1997			
	HEROISM	1997-	KYM-1DP	KYM-1DP	
			KYM-1P	KYM-1P	
	LAMBRETTA	LUI 50	-		IMS-3
					IMS-3P
					NE-56
LAVERDA	50 ATLAS	1986-1990	ZA-1	ZA-1	
	50 GAUCHO	1986-	ZA-1P	ZA-1P	
	125 CU RIDE	1986-1990			
	125 FORMULA	1986-1990			
	125 GS LES.	1984-			
	125 L ELEG.	1984-			
	125 LB CUS.	1984-			
	125 LB SAB.	1984-			
	125 LB UNO	1984-			
	125 LESMO G	1986-1990			
	125 LZ CUS.	1984-			
	350 LESMO	1984-			
	600 ATLAS O	-			
	1000 SFC	1986-			
	V6 1000 R	-			
	50 LZ	-	NE-8	NE-8	
	125 LZ	1978-	NE-6	NE-6	
	125 LZ C.	1978-	NE-6P	NE-6P	
	125 LZ S.	1978-	NE-8		
	500 4T	-	SUZU-13P	NE-6	
	500 SFC	-	SUZU-4I	NE-6P	
	750	1978-	SUZU-4IP		
1000	1978-				
1000 JOTA	-				
1000 JOTA 120	-				
1000 RGS	-				
1200	1978-				
1200 TS	1978-				
PHOENIX	2003-	ZA-8P	ZA-8P		
LINCE	125 SERVETTE	-		CL-2I	
	150 SERVETTE	-		CL-3I	
	200 SERVETTE	-			
MAICO	GM STAR 250E	-		CL-2I	
	GM STAR 500E	-		CL-3I	
	GM STAR SID.	-		NE-6	
				NE-6P	
			NE-8		
MALAGUTI	50 MDX	1986-1991	ZA-1	ZA-1	
	50 MEX	1986-1991	ZA-1P	ZA-1P	
	50 MFX	1986-1991			
	50 MGX	1986-1991			
	CUSTOM	1986-1991			
	FIFTY FULL	1986-			
	FIFTY HF 50	1986-1991			



MOTOCICLETA

MOTORCYCLE

MARCA BRAND	MODELO MODEL			
MALAGUTI	FIFTY TOP 50	1986-		
	RUNNER YLC	1986-1991		
	TOP 50	1986-1991		
	125	1986-		ZA-1
	125 RUNNER	1986-		ZA-1P
	CAVALCONE 80	-		
	CHOPPER 25	-		
	CHOPPER 40	-		
	CHOPPER 80	-		
	DRIBBLING	1986-		
	DROP	-		
	DUNE ES	1986-		
	DUNE KS	1986-		
	FIFTY	-		
	FIRE BIRD	-		
	GRIZLY UNO	-		
	MRX ENDURO	1986-		
	NEW DRIBLING	-		
	PULL CX	-		
	CENTRO SL	1994	ZA-4DP	ZA-4DP
	CROSSER 50	1994-		
	F 10	1994		
	PHANTOM	1994		
	RS	1991		
	F 10 JET	1992-	YAMA-27	YAMA-27
			YAMA-27D	YAMA-27D
		YAMA-27DP	YAMA-27DP	
		YAMA-27P	YAMA-27P	
		YAMA-30P	YAMA-30P	
FIREFOX F15	1996-1997	ZA-9P	ZA-9P	
MADISON	2003-			
RST 50	1991-1992	ZA-13P	ZA-4DP	
		ZA-4DP		
MALANCA	125 MARKT	-	ZA-1	ZA-1
			ZA-1P	ZA-1P
	BIG	-		ZA-1
	GTS 4 4M	-		ZA-1P
	GTS 5	-		
	LP	-		
	LPRL	-		
MBK	BOOSTER	1995-1997	ZA-4DP	ZA-4DP
	EVOLIS	1995-		
	FORTE	1995-		
	NEW SORRISO	1995-		
	BOOSTER	1998	ZA-9P1	ZA-9P1
	KILIBRE	2003-		
	OVETTO	1998		
	BOOSTER 50	-	YAMA-27	YAMA-27
	EVOLIS	-	YAMA-27D	YAMA-27D
	SCOOTER	-	YAMA-27DP	YAMA-27DP
	SORRISO	-	YAMA-27P	YAMA-27P
	TARGET	-	ZA-4DP	ZA-4DP
	MBM	BREEZE LUSSO	-	
BULL		-		ZA-1P



MARCA BRAND	MODELO MODEL			
MBM	CRAZY	-		
	PONY	-		
	SOGNO	-		
MONTESA	250 ENDURO	-1991		CL-2I
	250 KING SC.	-1991		CL-3I
	348 TRIAL	-1991		
	360 ENDURO	-1991		
	CAPPRA 250	-1991		
	COTA 50	-1991		
	COTA 50 AR.	-1994		
	COTA 50 H2O	-1994		
	COTA 123 C	-1991		
	COTA 125	-1991		
	COTA 200	-1991		
	COTA 242 T	-1991		
	COTA 247	-1991		
	COTA 250	-1991		
	COTA 304	-1991		
	COTA 307	-1991		
	COTA 330	-1991		
COTA 335	-1991			
COTA 348	-1991			
COTA 349	-1991			
COTA 350	-1991			
MORINI FRANCO	GIULIETTA O.	-		ZA-1
	LEM	-		ZA-1P
MOTO GUZZI	65 GT	1984-	IMS-5	NE-6
	650 NTX	1984-	IMS-5P	NE-6P
	850 LE MANS	1981-		NE-8
	850 T3 C.	1981-		
	850 T3-T4	1981-		
	V 35	1982-1984		
	V 35 II	1982-1984		
	V 35 IMOLA	1982-1984		
	V 50	1990-		
	V 50 C	1982-1984		
	V 50 C	1984-		
	V 50 CH.	1982-		
	V 50 III	1982-1990		
	V 50 III	1990-		
	V 50 MONZA	1982-1984		
	V 50 MONZA	1984-		
	V 50 TS	1982-		
V 65	-			
V 65	1984-			
V 65 C	1984-			
V 65 FL.	1984-			
V 65 II	1984-			
V 65 LA.	1984-			
V 65 SP	1984-			
V 65 TT	1984-			
V 75	-			
V 75	1984-			
125 BX	1986-		NE-8	



MARCA BRAND	MODELO MODEL			
MOTO GUZZI	125 CUSTOM	1986-		
	125 TT	1986-		
	125 TURISMO	-		NE-6
	850 T3	1986-		NE-6P
	DINGO	-		
	STORNELLO	-		
	125 TURISMO	1981-	IMS-5	NE-8
	254	-	IMS-5P	
	V 35	1984-		
	V 35 C	1984-1986		
	V 35 F.	1984-		
	V 35 II	1984-		
	V 35 III	1984-		
	V 35 IMOLA	1984-		
	V 1000 I LE.	1984-		
	V 1000 IDRO.	1984-		
	V 1000 II L.	1984-		
	250 ELECTR.	-	FEM-2D FEM-2I	NE-8
	250 TS	-	FEM-2D	NE-6
	350 GTS	-	FEM-2I	NE-6P
	350	1979-	IMS-5	NE-6
	500	-	IMS-5P	NE-6P
	850 T5	1986-		
	SP 1000 II	1984-		
	V 1000 CALI.	1984-		
	V 1000 CONV.	1984-		
	V 1000 GT	1984-		
	V 1000 SP	1984-		
	V 1000 SP II	1984-		
	350 NEVADA	1994	ZA-1	ZA-1
	750 NEVADA	1994-	ZA-1P	ZA-1P
	750	1979-	FEM-1D	NE-6
	850 LE MANS	1979-1981	FEM-1I	NE-6P
	850 T3	1979-1986	SIP-3	
	850 T3 C.	1979-1981		
	V 1000 C.	1979-		
750 NTX	1990-	ZA-1	NE-8	
V 75 NTX	1990-	ZA-1P		
850 GT	1986-	FEM-1D FEM-1I	NE-6 NE-6P	
1000 GT RL	1990-	IMS-5	ZA-1	
1000 GT RR	1990-	IMS-5P	ZA-1P	
1000 LE MANS	1990-			
1000 S	1990-			
1000 ST II	-			
1000 ST III	-			
V 35 C	1986-			
V 35 GT	1986-			
V 35 NTX	1986-			
V 35 TT	1986-			
BREVA	2003-	ZA-9P1	ZA-9P1	
CALIFOR. EV	2003-			
V 11	2003-			



MARCA BRAND	MODELO MODEL			
MOTO GUZZI	FAL.SAHARA	-	FEM-1D	
	V 7 SPORT	-	SIP-3	NE-6 NE-6P
	V 1000 G5	1979-	IMS-5 IMS-5P	IMS-5 IMS-5P
MOTO MORINI	3 1/2 SPO.	1981-	FEM-1D	NE-6
	3 1/2 V	1981-	FEM-1I	NE-6P
	125 T	1981-		
	250	1981-		
	250 BIC	1981-		
	500 GV	-		
	500 KANGEROO	-		
	500 T/S	-		
	50 CORSARIO	-		NE-6
	125 CORSARIO	-		NE-6P
	250 KANGURO	1979-		
	250 STRADA	1979-		
	550	1979-		
	125 H	1984-	FEM-2D	ZA-1
	125 KJ	1984-	FEM-2I	ZA-1P
	350 COGUARO	1986-	AF-6D	ZA-1
	350 EXCALIB.	1986-		ZA-1P
	350 KANGURO	1986-		
	350 NEW YORK	1986-		
	350 XE	1986-		
501 COGUARO	1986-			
501 EXCALIB.	1986-			
501 KANGURO	1986-			
501 NEW YORK	1986-			
500 CAMEL	-	AF-6D	NE-8	
MOTOBECANE	125 LT	-	LAS-X	NE-6
	SUPERMOBY 51	-		NE-6P
MOTOBI	254	-	IMS-5 IMS-5P	NE-8
MOTRON	3/TRE-RCV	-		ZA-1
	MST	-		ZA-1P
	RA PL 4P	-		
	SU 3R 1D	-		
	TAXI AP	-		
	TAXI ES 1D	-		
	COMPACT	1990-1991	ZA-1	ZA-1
	GL 4	1990-1991	ZA-1P	ZA-1P
	GTO	1990-1991		
	INVADER	1990-1991		
SHOPPING	1990-1991			
TAXI ES ID	1990-1991			
TAXI KS SL	1990-1991			
MV AUGUSTA	125 S	-	FEM-1I	
	125 SPORT	-		FEM-1I
	350 SPORT	-		FEM-2I
	350 S	-	AF-7I AF-7IP	AF-7I AF-7IP
	750 S	-	SUZU-13P SUZU-4I	NE-6 NE-6P



MOTOCICLETA

MOTORCYCLE

MARCA BRAND	MODELO MODEL			
MV AUGUSTA			SUZU-4IP	
MZ	TOUR	1994	ZA-4DP	
NORTON	850 COMMANDO	-	UN-3	
OMC	CITY	-		ZA-1
	ELITE	-		ZA-1P
	ELITE SL	-		
	ELS-SL	-		
	EXCLAIM	-		
	HI TECH	-		
	MARINER-SL	-		
	MUDDY	-		
	MUDDY JUNIOR	-		
	WILD ELITE	-		
	WILD MS	-		
	WILD TIGRE	-		
OSSA	125	-	CAS-1D	NE-6
	250 ENDURO	-		NE-6P
	350 ENDURO	-		
	250 DESERT	-		CL-2I
	250 EXPLORER	-		CL-3I
	250 FUEGO	-		
	250 ORANGE	-		
	250 SUPER	-		
	250 TRIAL	-		
	250 TU	-		
	250 TURISMO	-		
	250 YO	-		
	350 EXPLORER	-		
	350 ORANGE	-		
	350 TRIAL	-		
	TRIAL 303	-		
	TRIAL JELLOW	-		
PERIPOLI	COLORADO	-		ZA-1
	DAY LXR/SA	-		ZA-1P
	DAY S 5/K	-		
	GIULIETTA	-		
	MINI L SAM1K	-		
	OXFORD	-		
	OXFORD ROAD	-		
	TIR	-		
	VAI M03	-		
	VAI R	-		
	WILD	-		
PEUGEOT	BUXY	1994-1997	ZA-12	ZA-12
	FOR LUX	1994-1998		
	SPEEDAKE	1995-1997		
	SQUAB	1995-1996		
	ZENITH	1994-1996		
	LOOXOR	2001		NE-45
	LUDIX	2004		NE-45P
	SPEEDFIGHT	1997		
	SV GEO	1991-1995		
	TREKKER	1998		
	VIVACITY	1999		



MARCA BRAND	MODELO MODEL			
PEUGEOT	X-RACE	2003		
	SC 50 L SCO.	-	SUZU-13P	SUZU-13P
	SC 80 L SCO.	-	SUZU-4I	SUZU-4I
	ST 50 L SCO.	-	SUZU-4IP	SUZU-4IP
	SV 125 SCO.	-		
	SQUAB	1997	NE-45P	
	SV 50 GEO	1992-	NE-45	NE-45
	SV 80 GEO	1993-	NE-45P	NE-45P
	SV 125 GEO	1993-		
	PGO	COMET	2000-	PGO-2P
PMS		2000-		
PMX		2000-		
RODOSHOW		2000-		
TREX		2000-		
SCOOTER		-	PGO-1	
PIAGGIO		APE 600 MP	1979-1981	
	APE CAR	-	AF-9D	FAB-1
	APE CAR P3	-	AF-9DP	
	APE CARP 601	-	AF-9I	
			AF-9IP	
			FEM-1D	
			FEM-1I	
	APE P 50	-	FEM-1D	NE-6
	APE TM P 50	-	FEM-1I	NE-6P
	VESPA 50	1979-1983		
	VESPA 50 ES	1981-1983		
	APE TM 703	-	AF-9D	FAB-1
	NICA 125	-	AF-9DP	
			AF-9I	
			AF-9IP	
	BOSS 50	1986-		ZA-1
	BRAVO	1992-		ZA-1P
	BRAVO 50	1986-		
	CIAO	1992-		
CIAO 50	1986-			
GRILLO	1992-			
GRILLO 50	1986-			
SI	1992-			
SI 50	1986-			
BOXER 50	1982-1986		NE-8	
BRAVO 50	1982-1986		ZA-1	
CIAO 50	1982-1986		ZA-1P	
SI 50	1982-1986			
CARNABY	2007		FI-13P1	
FLY	2005-2012			
SKIPPER	1999-2000			
VESPA	1996			
ZIP	2000-2011			
COSA 125	1988-	ZA-2P	ZA-2P	
COSA 150	1988-			
COSA 200	1988-			
SFERA	1992-			
VESPA 50 PK	1986-			
VESPA FL 2	1986-			



MARCA BRAND	MODELO MODEL			
PIAGGIO	VESPA PLURI.	1986-		
	VESPA RUSH	1986-		
	COSA 125 MA	1992-	FI-1	FI-1
	COSA 150 MA	1992-	FI-1P	FI-1P
	COSA 2 125	1993-	ZA-2P	ZA-2P
	COSA 2 150	1993-		
	COSA 2 200	1993-		
	COSA 200 MA	1992-		
	VESPA 125 E	1984-		
	VESPA P 125	-		
	VESPA P 125	1984-1991		
	VESPA PK 125	-		
	VESPA PX 125	1984-1991		
	VESPA PX 150	1984-1991		
	VESPA PX 200	1984-		
	FREE RL	1995	ZA-7DP	
	HEXAGON 125	1994-1997	ZA-4DP	ZA-4DP
	NRG	2002-2005		ZA-7DP
	SKIPPER	1993-1998		
	TYPHOON	1994-2010		
	ZIP	1994-1999		
	NRG	2006		ZA-9P
	QUARTZ	1992-	ZA-2P	ZA-2P
	VESPA 50	1992-	ZA-7DP	ZA-7DP
	ZIP	1992-1993		
	SCATTO	-1991	ZA-13P	ZA-13P
	SFERA	1995-1998	ZA-7DP	ZA-7DP
	TOLEDO-SC	-		CL-2I CL-3I
	VESPA 125 E	1981-1984		NE-6
	VESPA 150	1979-		NE-6P
	VESPA 150 RA	1979-		
	VESPA 150 SV	1979-		
VESPA P 80X	-			
VESPA P 125X	1981-			
VESPA P 150X	1981-			
VESPA P 200X	1981-			
VESPA PX 200	1986-			
VESPA PX125E	1981-			
VESPA 125 ET	1979-	FEM-1D	ZA-1	
VESPA 200 PX	1979-	FEM-1I	ZA-1P	
VESPA P 150X	1979-1981			
VESPA 125ET3	-1979	FEM-1I	NE-6 NE-6P	
VESPA PK 50	1984-1986	FI-1	FI-1	
VESPA PK 50S	1984-1986	FI-1P	FI-1P	
RALEIGH	CICLI	-		LF-2
	CYCLES	-		UN-FP
RIZZATO	ATALA	1995	ZA-4DP	
	HACKET AT12	1995		
	HACKET RACI.	1995		
SULKI	50	-1992	BH-4	BH-4
	125	1992-		
SUZUKI	400 ENDURO	1978-	SUZU-13P	



MARCA BRAND	MODELO MODEL			
SUZUKI	400 S	1978-	SUZU-4I	
	GS 400 T	-	SUZU-4IP	
	GT 350	1978-		
	GT 500	1978-		
	650 DJEBEL	-1991	SUZU-13P	SUZU-13P
	DR 125 S	-	SUZU-4I	SUZU-4I
	DR 250 S	1984-	SUZU-4IP	SUZU-4IP
	DR 400	1980-1985		
	DR 500	1984-1986		
	DR 600	1985-		
	DR 650	1990-1991		
	DR 750 BIG	1988-1991		
	DR 800 SL	1990-		
	GS 125 ES	1984-		
	GS 550	1984-1985		
	GS 850	1980-1982		
	RGT 125	-		
	TS 125 S	-		
	TS 125 X	-		
	ADDRESS	1992-	SUZU-11D	SUZU-11D
	ADDRESS 100	1994	SUZU-11DP	SUZU-11DP
	DR 350 SE	1994		
	DR 650	1992-		
	GS 400	1993-		
	GS 500	1989-		
	GS 750	1991-		
	GSF 400	1993-	SUZU-13P	SUZU-13P
	GSF 500 EP	1993-	SUZU-4I	SUZU-4I
	GSF 600	1995	SUZU-4IP	SUZU-4IP
	GSX 600	1989-1997	SUZU-5	SUZU-5
	GSX 750	1988	SUZU-5P	SUZU-5P
	GSX 1100 92	1992-	SUZU-13P	NE-8
	GSXR 750	1989-1996	SUZU-4I	SUZU-13P
	GSXR 1100	1990-	SUZU-4IP	SUZU-4I
	RF 600 R	1993-	SUZU-5	SUZU-4IP
	RF 900 R	1994-	SUZU-5P	SUZU-5
	RG 125	1995		SUZU-5P
	RS 650	1991	SUZU-12DP	
	VS 750	1989-		
	VS 800	1992-		
	VS 1400	1990-		
	VX 800	1990-		
AH 50	1991-	YAMA-20I	YAMA-20I	
CP 50	1991-	YAMA-24IP	YAMA-24IP	
		YAMA-28P	YAMA-28P	
AJ 50 ZZ	1995	ZA-4DP	ZA-4DP	
AP 50	1995			
AN 125	1995	YAMA-23DP	NE-8	
VS 600 GL	1995	YAMA-23IP		
VS 800 GL	1995			
CC 1	-	SUZU-13P	NE-8	
RV 90	-	SUZU-4I		
		SUZU-4IP		
DL 1000	2003-	SUZU-12DP	SUZU-12DP	



MOTOCICLETA

MOTORCYCLE

MARCA BRAND	MODELO MODEL			
SUZUKI	DR 650 RSE	1995-	YAMA-19D	YAMA-19D
	GS 500 F	2004-	YAMA-19DP	YAMA-19DP
	GS 500 E	1995-	YAMA-19I	YAMA-19I
	GSF 600	1995-	YAMA-19IP	YAMA-19IP
	GSF BANDIT	2004-	YAMA-20D	YAMA-20D
	GSX R1300	2004-	YAMA-20I	YAMA-20I
	GSXR 750 SP	1995-	YAMA-20IP	YAMA-20IP
	GSXR 750 W	1995-	YAMA-22DP	YAMA-22DP
	GSXR 1000	2003-	YAMA-22IP	YAMA-22IP
	GSXR 1100	1995-	YAMA-23DP	YAMA-23DP
	GZ 250	2004-	YAMA-23IP	YAMA-23IP
	LR GSX 600	2004-	YAMA-24DP	YAMA-24DP
	SV 650 S	2003-	YAMA-24IP	YAMA-24IP
	SV 1000 S	2003-	YAMA-28P	YAMA-28P
	SV 650	2004-	YAMA-29P	YAMA-29P
	SV 750	2004-	AF-6D	NE-6
	VL 800	2004-		
	V-STROM 650	2004-		
	V-STROM 1000	2004-		
	VZ 1600	2004-		
	DR 125 SE	1995	YAMA-20D	NE-8
	LS 650	1995	YAMA-20I	
	VS 1400 GLP	1995	YAMA-20IP	
	DR 350	1997	YAMA-20I	
	DR 350 S	1993-	YAMA-20D	NE-8
	DR 350 SM	1992-	YAMA-20I	
	DR 350 SN	1992-	YAMA-24DP	
	VS 750 J.	-	YAMA-24IP	
			YAMA-28P	
	G 450 L	1980-	SUZU-5	SUZU-5
	GN 400	1985-	SUZU-5P	SUZU-5P
	GNX 250	1985-1991		
	GR 650	1982-		
	GS 450	1980-		
	GS 500	1984-1989		
	GS 550	1982-1984		
	GS 750	1982-1987		
	GS 850	1982-1985		
	GSX 250 S	1985-1991		
	GSX 400	1985-		
	GSX 500	1989-		
	GSX 550	1985-		
	GSXR 1100	1981-		
	LS 650	1982-		
	LT 250 A	1985-1991		
	RG 250 R	1985-1991		
	RGV 250	1985-1991		
	GS 1000	1982-1985	SUZU-13P	SUZU-13P
	GSX 1100	1981-1985	SUZU-4I	SUZU-4I
	RG 500	1985-	SUZU-4IP	SUZU-4IP
		SUZU-5	SUZU-5	
		SUZU-5P	SUZU-5P	
GSX 600	1998-2006		SUZU-12D	
GSX 750	1988-2006		SUZU-12DP	



MARCA BRAND	MODELO MODEL			
SUZUKI	GSX 1300 HA.	1999-2006		
	TL 1000	1997-2002		
	TU 125	1999		
	TU 250	1997-2001		
	GSX 1200	1999-2000		
	GSX 1400	2002-2005		
	GZ 125	1998		
	RV 125	2003		
	XF 650	1997-2001		
	GSX 750	1981-1987	SUZU-13P	NE-8
			SUZU-4I	SUZU-13P
			SUZU-4IP	SUZU-4I
			SUZU-5	SUZU-4IP
			SUZU-5P	SUZU-5
				SUZU-5P
	GSXR 600	1997	SUZU-12DP	
	GSXR 750	1997		
	GT 550	1978-	SUZU-3I	
	GT 750	1978-		
	INTRUDE.1400	1993-	YAMA-19D	NE-8
	VS 800 GL	1993-1995	YAMA-19DP	
			YAMA-19I	
			YAMA-19IP	
			YAMA-23DP	
			YAMA-23IP	
			YAMA-29P	
	KATANA	1997	ZA-4DP	
	KATANA R	2004-	ZA-9P1	ZA-9P1
	VS 750 INT.	1986-	YAMA-18D	YAMA-18D
			YAMA-18DP	YAMA-18DP
		YAMA-18I	YAMA-18I	
		YAMA-18IP	YAMA-18IP	
		YAMA-19D	YAMA-19D	
		YAMA-19DP	YAMA-19DP	
		YAMA-19I	YAMA-19I	
		YAMA-19IP	YAMA-19IP	
		YAMA-20D	YAMA-20D	
		YAMA-20I	YAMA-20I	
		YAMA-20IP	YAMA-20IP	
		YAMA-22DP	YAMA-22DP	
		YAMA-22IP	YAMA-22IP	
		YAMA-23DP	YAMA-23DP	
		YAMA-23IP	YAMA-23IP	
		YAMA-24DP	YAMA-24DP	
		YAMA-24IP	YAMA-24IP	
		YAMA-28P	YAMA-28P	
		YAMA-29P	YAMA-29P	
SWM	124 RZ	-	AF-6D	NE-6
	280 GS	-		NE-6P
	EXPLORER 125	-		
	EXPLORER 350	-		
	GS 125	-		
	GT 125	-		
GTS 125	-			



MARCA BRAND	MODELO MODEL			
SWM	RS 125	-		
	RS 250	-		
	TL 329	-		
	350 XN	-	ZA-1	ZA-1
			ZA-1P	ZA-1P
	WPM 1	-		NE-6
				NE-6P
TESTI	CRICHET PULL	-		NE-6
				NE-6P
TRIUMPH	AMERICA	2006-	TRP-1D	
	BONNEVILLE	2006-	ZA-9P1	
	DAYTONA	2006-		
	ROCKET III	2006-		
	SCRAMBLER	2006-		
	SPEEDMASTER	2006-		
	SPRINT ST	2006-		
	THRUXTON	2006-		
	TIGER	2006-2009		
	TRIDENT	-	UN-3	NE-6
				NE-6P
YAMAHA	250 COMPETI.	-	YAMA-3I	YAMA-3I
	400	-	YAMA-14I	YAMA-14I
	RD 400	-	YAMA-15D	YAMA-15D
			YAMA-15I	YAMA-15I
	400 BICILIN.	-	YAMA-17D	YAMA-17D
			YAMA-17I	YAMA-17I
	500	1979-	YAMA-9I	YAMA-9I
	500 ENDURO	1979-	YAMA-14I	YAMA-14I
	RD 500	1979-		
	TT 350	1995		
	600 ACERBIS	1980-	YAMA-14D	YAMA-14D
	OHC 650	1980-	YAMA-14I	YAMA-14I
	RD 50 M	-		
	XT 50	-		
	AEROX	1998	ZA-9P1	ZA-9P1
	BT 1100 BU.	2003-		
	MAJESTY 250	2005-		
	NEOS	1998		
	VERSITY 300	2003-		
	AXIS	1995-	ZA-4DP	ZA-4DP
	BREEZE	1994		
	BREEZE	1995-		
	SPY	1995-		
	BL 125 BE.	1984-1991	YAMA-18D	NE-8
	DT 125 BA.	1984-1991	YAMA-18DP	
	DT 125 BB.	1984-1991	YAMA-18I	
	DT 125 CF.	1984-1991	YAMA-18IP	
	DT 125 R	1984-1986	YAMA-19D	
	FZ 400	1984-	YAMA-19DP	
	FZR 400	1984-	YAMA-19I	
	FZR 600	1984-1992	YAMA-19IP	
	RD 350	1984-1991	YAMA-20D	
	RD 350 LC	1984-1991	YAMA-20I	
	RD 550	1984-	YAMA-20IP	YAMA-14D



MARCA BRAND	MODELO MODEL			
YAMAHA	RT 125 LL	1984-1991	YAMA-22DP	YAMA-14I
	SCROW 225	1984-1991	YAMA-22IP	YAMA-15D
	SR 250	1984-1991	YAMA-23DP	YAMA-15I
	SR 250 SE	1984-	YAMA-23IP	YAMA-3D
	SR 250 SP.	1984-	YAMA-24DP	YAMA-3I
	SR 500 G-S	1984-	YAMA-24IP	YAMA-21I
	SR 600	1984-	YAMA-28P	YAMA-21IP
	TDR 125	1984-1991	YAMA-29P	
	TDR 250	1984-1991		
	TR 1	1984-		
	TZR 125	1984-1991		
	TZR 250	1984-1991		
	XD 250 LC	1984-		
	XJ 600	1984-		
	XJ 650 SP.	1984-		
	XJ 650 TT.	1984-		
	XJ 750 NS	1984-		
	XJ 750 SE.	1984-		
	XJ 900 F	1984-		
	XJ 900 S	1984-		
	XS 350	1984-1991		
	XS 850	1984-		
	XT 400 SP.	1984-		
	XT 500	1984-		
	XT 550	1984-		
	XT 600	1984-1991		
	XT 600 4V.	1984-1991		
	XT 600 N	1984-		
	XT 600 TE.	1984-1991		
	XT 600 YD.	1984-		
	XT 600 Z-ZA	1984-1991		
	XU 500 SE	1984-		
	XV 535	1984-		
	XV 1000 SE	1984-		
	XZ 550 LC-S	1984-		
	YZ 125 LC	1984-1991		
	YZ 250 LC	1984-1991		
	YZ 490	1984-		
	BL 125 BE.	1991-	YAMA-18D	NE-8
	DT 125 BA.	1991-	YAMA-18DP	
	DT 125 BB.	1991-	YAMA-18I	
	DT 125 CF.	1991-	YAMA-18IP	
	DT 125 R	1991-1992	YAMA-19D	
	RD 350	1991-	YAMA-19DP	
	RD 350 LC	1991-	YAMA-19I	
	RT 125 LL.	1991-	YAMA-19IP	
	SCROW 225	1991-	YAMA-20D	
	SR 250	1991-	YAMA-20I	
	TDR 125	1991-1992	YAMA-20IP	
	TDR 250	1991-		
	TT 350	1991-1995		
	TZR 125 R	1991-1992		
	TZR 250	1991-		
	XT 600	1991-		

MOTOCICLETA

MOTORCYCLE

MARCA BRAND	MODELO MODEL			
YAMAHA	XT 600 4V.	1991-		
	XT 600 TE.	1991-		
	XT 600 Z-ZA	1991-		
	YZ 125 LC	1991-		
	YZ 250 LC	1991-		
	CR 50 Z	1992-	YAMA-27	YAMA-27
	CT 50 S	1992-	YAMA-27P	YAMA-27P
	SCOOTER MBK	1991-		
	CT 50 SS	1995	YAMA-27DP	YAMA-27DP
			YAMA-27P	YAMA-27P
	DT 125	-1985	YAMA-3D	YAMA-3D
	DT 125 LC.	-1985	YAMA-3I	YAMA-3I
	TX 650	1979-		
	TX 750	1979-		
	DT 125	1992-	YAMA-18D	YAMA-18D
	DT 125 B	1992-	YAMA-18I	YAMA-18I
	DT 125 R	1992-	YAMA-19D	YAMA-19D
	DT 125 Z	1992-	YAMA-19I	YAMA-19I
	TT 600	1993	YAMA-20D	YAMA-20D
	TT 600 S	1991-	YAMA-20I	YAMA-20I
	TZR 125 R	1992-	YAMA-22DP	YAMA-22DP
	TZR 125 RSP	1992-	YAMA-22IP	YAMA-22IP
	XT 600 A	1993-	YAMA-23DP	YAMA-23DP
	XT 600 E	1991-	YAMA-23IP	YAMA-23IP
	XT 600 ZA	1991-1992	YAMA-24DP	YAMA-24DP
			YAMA-24IP	YAMA-24IP
			YAMA-28P	YAMA-28P
			YAMA-29P	YAMA-29P
	DT 125 CO.	1986-1992	ZA-1	ZA-1
	DT 125 LC.	1986-1992	ZA-1P	ZA-1P
	DT 125 R	1986-1991		
	DT 250	-	YAMA-14D	YAMA-14D
	DT 250 MX	-	YAMA-14I	YAMA-14I
	RD 250	-	YAMA-15D	YAMA-15D
			YAMA-15I	YAMA-15I
			YAMA-3D	YAMA-3D
			YAMA-3I	YAMA-3I
	FJ 1100	1984-	YAMA-21I	YAMA-21I
	FJ 1200	1984-	YAMA-21IP	YAMA-21IP
	FS 1200	1984-		
	FZ 600	1984-	YAMA-23IP	
	FZ 600 GE.	1984-	YAMA-24DP	
	FZ 750 A-R	1984-	YAMA-24IP	
FZR 600	1992-	YAMA-28P		
FZR 1000	1984-	YAMA-29P		
FZR 1000 E.	1984-	YAMA-5D	YAMA-5D	
FZX 750	1984-	YAMA-5I	YAMA-5I	
GENESIS FZR	1992-	YAMA-14I	NE-8	
RD 500 YP.	1984-			
SUPER T. 750	1992-			
TDM 850	1991-	YAMA-18I	ZA-1	
TT 350	1984-1991	YAMA-18IP	ZA-1P	
TT 600 S	1984-1991	YAMA-19I	ZA-1	

MARCA BRAND	MODELO MODEL			
YAMAHA	V MAX 86	1984-	YAMA-19IP	ZA-1P
	VMX 12 N	1984-	YAMA-20D	YAMA-20D
	XJ 400	1984-		
	XJ 600 N	1984-		
	XJ 650 T	1984-		
	XJ 650 TU.	1984-		
	XJ 750 N	1984-		
	XJ 750 S.	1984-		
	XTZ 750	1984-		
	XTZ 750 T.	1984-		
	XV 500 SE	1984-		
	XV 750 SE	1984-		
	XV 1000 V.	1984-		
	XV 1100	1984-		
	XZV 12 T	1984-		
	XZV 12 TD	1984-		
	XZV 13 TD	1984-		
	FRZ 600	1995-	YAMA-26	YAMA-26
	FRZ 600 R	1994-	YAMA-26D	YAMA-26D
	FZX 600 R	1995-	YAMA-26DP	YAMA-26DP
	GTS 1000	1993-	YAMA-26P	YAMA-26P
	GTS 1000 ABS	1993-		
	TDM	1996-		
	TDM 850	1995-		
	TRX 850	1995-		
	XJ 600 E	1995-		
	XJ 600 S D.	1995-		
	XJ 900 S D.	1995-		
	XT 500	1979-1984		
	XT 600 E	1995-		
	XTZ 660	1994-		
	XVS 110 D.S.	1998-		
	XVS 650	1996-		
	XVZ 1300	1996-		
	YP 250 MAJES	1996-		
	YZF 600	1996-		
	YZF 750 R	1993-		
	YZF 750 SP	1993-		
	YZF 1000	1996-		
	FS 1	-1986	YAMA-16D	YAMA-16D
	RD 125	-1986	YAMA-16I	YAMA-16I
			YAMA-3D	YAMA-3D
			YAMA-3I	YAMA-3I
FZX 600 R	1994	YAMA-19D	YAMA-19D	
TW 200	1994	YAMA-19DP	YAMA-19DP	
FZX 600 R	1995	YAMA-19I	NE-8	
TW 200	1995	YAMA-23IP		
		YAMA-29P		
FZX 750	1995	YAMA-18D	NE-8	
		YAMA-22DP		
RD 350	-	YAMA-3D	YAMA-3D	
XS 500 B	1979-	YAMA-3I	YAMA-3I	
		YAMA-9D	YAMA-9D	

MARCA BRAND	MODELO MODEL			
YAMAHA			YAMA-9I	YAMA-9I
	RD 500 LC	1984-	YAMA-18D	NE-8
	XJ 550	1984-	YAMA-18DP	YAMA-21I
	XS 400	1984-	YAMA-18I	YAMA-21IP
			YAMA-18IP	
			YAMA-19D	
			YAMA-19DP	
			YAMA-19I	
			YAMA-19IP	
			YAMA-20D	
			YAMA-20I	
			YAMA-20IP	
			YAMA-21I	
			YAMA-21IP	
			YAMA-22DP	
			YAMA-22IP	
			YAMA-23DP	
			YAMA-23IP	
			YAMA-24DP	
			YAMA-24IP	
			YAMA-28P	
			YAMA-29P	
	RS 125 C.	-1986	YAMA-5D	YAMA-5D
			YAMA-5I	YAMA-5I
	SR 500 G	1979-1984	YAMA-14I	NE-8
	SR 500 S	1979-1984		
	XT 500	1979-1984		
	TDR 125	1992-	YAMA-18I	ZA-1
	TDR 125 R	1992-	YAMA-18IP	ZA-1P
	TDR 125 R	1990-1991	YAMA-19I	ZA-1
			YAMA-19IP	ZA-1P
	TT 600	1994	YAMA-20D	YAMA-20D
	TT 600 E	1994		
	XT 600 A	1994		
	XT 600 E	1994		
	TT 600	1995	YAMA-20I	YAMA-20I
	XT 600 A	1995	YAMA-24IP	YAMA-24IP
	XT 600 E	1995	YAMA-28P	YAMA-28P
	XC 125 CYGN.	1995	YAMA-18D	YAMA-18D
			YAMA-22DP	YAMA-22DP
	XS 500	1979-	YAMA-13D	YAMA-13D
	XS 500 EV.	1985-	YAMA-13I	YAMA-13I
XS 750	1979-	YAMA-13I	YAMA-13I	
XS 1100	1984-	YAMA-13D	NE-8	
XS 1100 S	1984-	YAMA-13I		
XT 250	1990-	YAMA-17I	NE-8	
YPUS 125	1990-			
XT 400	-	YAMA-14D	NE-8	
YSR 50	1990-	YAMA-18D	NE-8	
		YAMA-18I		
		YAMA-22DP		
		YAMA-22IP		



THE KEY TO EXCELLENCE
GLOBALLY UNLOCKING MILLIONS OF DOORS DAILY

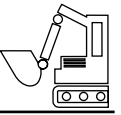
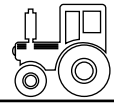
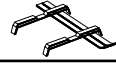
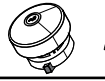
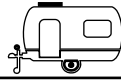
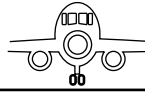

REFERENCIA REFERENCE	TIPO TYPE
-------------------------	--------------

ALP-11
ALP-2
ALP-2D
ALP-6
ALP-6D
CHI-1T
COB-1P
COB-2
DOM-11D
DOM-11I
GH-3
HU-NW
NE-60C1
NE-60C2
PO-2P
STS-X5
STS-X6
VA-61C1
VA-61C2
YW-1P
ZA-3D
ZA-5DP
ZA-5P



BOB-1D
CN-1D
MIT-1D
MIT-1DP
MIT-1I
MIT-1IP
MIT-2D
MIT-2DP
MIT-2I
MIT-2IP
TOYO-25
YA-11D
YA-11I
YA-27
YA-27D



ABU-3
ABU-13
ABU-13D
ABU-18DP
ABU-18P
ABU-19D
ABU-19DP
ABU-19P
ABU-21
ABU-35P
ABU-36P
ABU-40
ABU-42
ABU-42D
ABU-45
ABU-64P
ABU-65P
ABU-72P
AF-19
AF-19P



REFERENCIA REFERENCE	TIPO TYPE
-------------------------	--------------

AF-21
AF-21P
AS-2D
AS-2I
AS-17D
AS-21
AS-21D
AS-21DP
AS-21P
AX-1
AX-1D
AX-1DP
AX-1P
AX-2P
AX-3DP
AX-4DP
CI-4DP
CI-4IP
CI-5DP
CI-5IP
COB-1P
COB-2
FAR-1D
FAR-1I
FAR-2D
FAR-2I
FAR-3
FAR-3D
FAR-4D
IMS-3
IMS-3P
IMS-5
IMS-5P
IMS-13
IMS-13P
IN-1
IN-4
IN-5
LAS-2
LAS-3
LAS-4
LAS-4D
LAS-5
LAS-5D
LAS-6
LAS-6D
LAS-FH
LAS-KT
LAS-TK
LAS-U
LAS-X
LF-1D
LF-1I
LF-5
LF-5D
LF-15
LF-15D
LF-17
LF-32



REFERENCIA REFERENCE	TIPO TYPE
-------------------------	--------------

LUMA-1D
LUMA-1I
LUMA-2D
LUMA-2I
LUMA-3D
LUMA-3I
LUMA-4D
LUMA-4I
MQ-1D
MQ-1I
NE-30
NE-30P
NE-31
NE-31P
NE-32
NE-32P
RI-1D
RI-1I
RI-2D
RI-2I
RI-3D
RI-3I
STS-X6
TOK-4D
UN-1FS
UN-2
UN-3
UN-4
UN-44
UN-44D
UN-FFE
UN-FK
UN-FP
UN-FR
UN-FS
UN-MRN
UN-NG
VI-4DP
VI-4IP
YA-11D
YA-11I
ZA-1
ZA-1P
ZA-2P
ZA-3D
ZA-4DP
ZA-10
AF-19
AF-19P
AF-21
AF-21P
AU-AN
AU-ANP
DOM-3D
DOM-3I
DOM-4
DOM-4D
DOM-6D
DOM-6I



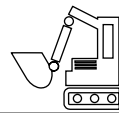
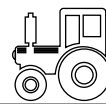
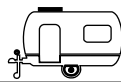
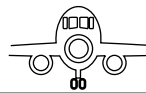

REFERENCIA REFERENCE	TIPO TYPE	REFERENCIA REFERENCE	TIPO TYPE	REFERENCIA REFERENCE	TIPO TYPE
BK-4 BK-4D BK-5D BK-5I BS-1I BS-4D BS-6 BS-7 BS-7D BS-8 BS-8D BS-9 BS-9D CHI-1 CHI-2 CHI-3 CHI-4 CHI-5 CLU-1D CLU-1I CLU-2 CLU-3 CLU-4 CLU-5 HUD-1 HUD-1D KEN-1 KEN-1D MIT-1D MIT-1DP MIT-1I MIT-1IP MIT-2D MIT-2DP MIT-2I MIT-2IP NE-1 NE-1D NE-1DP NE-1P NE-58D PLL-1 WST-1D WST-2D YA- 8D YA- 8I YA- 9I YA-11D YA-11I YA-27 YA-27D YA-37 YA-37D	MOTOR MARINO BOAT ENGINES	AF-21 AF-21P BL-2 BL-3 BL-4 BL-4D BL-6 BL-6D ECH-1 FAB-1 FAR-1D FAR-1I FAR-2D FAR-2I FAR-3 FAR-3D FAR-4D GIU-1 GIU-1D GIU-2 GIU-2D IMS- 3 IMS- 3P IMS- 5 IMS- 5P IMS-13 IMS-13P RO-5D RO-5I SI-1D SI-2D SI-3 SI-3D SI-4D VO-1 ZA-2P ZA-4DP	PORTA ESQUIS	DAR-1 FAB-1 FAB-2 FAR-1D FAR-1I FAR-2D FAR-2I FAR-3 FAR-3D FAR-4D FIA-2 GAS-1 GAS-1D GIOB-1D GIOB-1DP GIOB-2I GIOB-2IP HA-1D HA-1I HU-P IMS- 3 IMS- 3P IMS- 5 IMS- 5P IMS-13 IMS-13P LAS-2 LAS-3 LAS-4 LAS-4D LAS-5 LAS-5D LAS-FH LAS-R LAS-U LAS-V LAS-X LAS-Y PJ-1 PJ-2 PJ-2P PJ-3 PJ-K PJ-KP SI-1D SI-2D SI-3 SI-3D SI-4 SI-4D SI-5D VO-1 VO-6D WAS-1 WAS-3 WAS-3P WAS-4 WAS-4P	TAPON DE GASOLINA PETROL CAP
AF- 5D AF- 5I AF- 6D AF- 6I AF-19 AF-19P	PORTA ESQUIS SKI HOLDER	AB- 4D AB- 6D AB- 6I AB- 7I AB- 8D AB- 8I AB-10I AF- 5D AF- 5I AF- 6D AF- 6I AF-19 AF-19P AF-21 AF-21P BL-1D BL-1I BL-5 BL-5D BUR-30D CAM-1D CLI-1D	TAPON DE GASOLINA PETROL CAP		

