



Tél. 04 73 84 84 94

JMA  **2006-2008**

E Las llaves que aparecen en este catálogo son piezas JMA fabricadas por Alejandro ALTUNA S.A. o un subcontratista de éste. Están diseñadas para cilindros y cerraduras de los fabricantes cuyas marcas se indican en este catálogo.

Conforme a las disposiciones legales vigentes relativas a la propiedad industrial, las marcas o nombres comerciales indicados en este catálogo son propiedad exclusiva de los fabricantes de cilindros y cerraduras, así como de los fabricantes de automóviles, otros constructores, distribuidores y usuarios.

Dichas marcas o nombres comerciales se indican en calidad simplemente informativa con el fin de reconocer con rapidez la cerradura a la que corresponden nuestras piezas.

Este catálogo está reservado exclusivamente a profesionales de la reproducción de llaves que utilizan piezas JMA.

Los datos referentes a los productos de este catálogo tienen carácter indicativo. Manteniendo siempre las características básicas, nos reservamos el derecho de realizar, sin previo aviso, modificaciones técnicas, estéticas o de otro tipo, por razones de evolución de los productos en cuestión.

.....

EN The keys that appear in this catalogue are JMA parts manufactured by Alejandro ALTUNA S.A. or one of its subcontractors. They are designed for cylinders and locks made by the manufacturers whose trademarks are indicated in this catalogue.

In accordance with legal requirements relating to industrial property rights, the trademarks or trade names indicated in this catalogue are the exclusive property of the manufacturers of the cylinders and locks, as well as automobile manufacturers, other constructors, distributors and users.

The aforementioned trademarks or trade names are indicated simply for information purposes so that the lock to which our parts correspond can be recognised quickly and easily.

This catalogue is for the exclusive use of professional key copiers who use JMA parts.

Data referring to the products in this catalogue are indicative in nature. Although the basic characteristics are maintained at all times, we reserve the right to make, without previous notice, any technical, aesthetic or other types of changes involved in the development of the products in question.

.....

F Les ébauches de clés reportées sur ce catalogue sont des ébauches JMA fabriquées par Alejandro ALTUNA S.A. ou un de ses sous-traitants. Elles sont destinées aux cylindres et serrures des fabricants dont les marques sont indiquées dans ce catalogue.

Conformément aux dispositions légales en vigueur relatives à la propriété industrielle, les marques ou les dénominations commerciales citées dans ce catalogue sont la propriété exclusive des fabricants de cylindres et de serrures ainsi que des constructeurs de voitures, autres constructeurs, distributeurs et utilisateurs.

Ces marques ou dénominations commerciales sont indiquées à titre de simple information afin de connaître rapidement à quelle serrure nos ébauches sont destinées.

Ce catalogue est exclusivement réservé aux professionnels de la reproduction de clés, utilisant des ébauches JMA.

Les renseignements sur les produits de ce catalogue sont donnés à titre indicatif. Tout en gardant les caractéristiques de base, nous nous réservons le droit d'apporter, sans préavis, des modifications techniques, esthétiques ou autres, dues à l'évolution des produits en question.

.....

D Die in dem vorliegenden Katalog aufgeführten Schlüssel sind JMA-Teile, die von der Firma Alejandro ALTUNA, S.A., einem Zulieferanten von JMA, hergestellt werden. Sie sind für Zylinder und Schlösser derjenigen Hersteller entwickelt worden, deren Marken in diesem Katalog aufgeführt sind.

In Übereinstimmung mit den geltenden gesetzlichen Vorschriften bezüglich des gewerblichen Eigentums sind die im vorliegenden Katalog aufgeführten Marken und Firmennamen ausschließliches Eigentum der Zylinder- und Schloßhersteller, sowie der Automobilhersteller und anderer Konstrukteure, Vertreiber und Benutzer.

Diese Marken und Firmennamen werden nur zu Informationszwecken aufgeführt, mit dem Ziel, auf schnelle Weise zu erkennen, zu welchem Schloß unsere Teile gehören.

Dieser Katalog ist ausschließlich für Fachleute des Bereichs der Schlüsselreproduktion gedacht, die JMA-Teile verwenden.

Die Daten bezüglich der Produkte des vorliegenden Katalogs haben informativen Charakter. Bei Aufrechterhaltung der grundlegenden Eigenschaften behalten wir uns das Recht vor, aus Gründen der Entwicklung der entsprechenden Produkte und ohne Vorankündigung technische, ästhetische oder andere Änderungen vorzunehmen.

.....

I Le chiavi che appaiono in questo catalogo sono pezzi JMA fabbricati da Alejandro ALTUNA S.A. o da un subfornitore di quest'ultimo. Sono state progettate per i cilindri e le serrature dei produttori le cui marche sono indicate in questo catalogo.

Secondo le disposizioni legali vigenti riguardo alla proprietà industriale, le marche o le denominazioni commerciali indicate in questo catalogo sono proprietà esclusiva dei costruttori di cilindri e serrature, nonché dei costruttori di autovetture, altri costruttori, distributori ed utenti.

Tali marche o denominazioni commerciali sono indicati a titolo meramente informativo al fine di riconoscere rapidamente la serratura a cui corrispondono i nostri pezzi.

Questo catalogo è riservato esclusivamente agli addetti alla riproduzione di chiavi che impiegano pezzi JMA.

I dati riguardanti i prodotti di questo catalogo hanno un carattere orientativo. Mantenedone sempre le caratteristiche basilari, ci riserviamo il diritto di effettuare sui prodotti, senza preavviso, le modifiche tecniche, estetiche o di altro tipo, necessarie a causa dell'evoluzione dei prodotti in questione.

.....

Algunos modelos que están en este nuevo catálogo podrán recibirlos tanto con la marca y la referencia JMA como con otra marca del grupo ALTUNA. // Some of the keys in this new catalogue could be received either with the JMA reference and trademark or with another trademark from the ALTUNA group. // Des ébauches de, cet catalogue pourront être livrées soit avec la marque et référence JMA soit avec une autre marque du groupe ALTUNA. // Einige Modelle des neuen Katalogs können Sie sowohl mit der Marke und der Bezeichnung JMA erhalten, als auch mit jeder anderen Marke der Gruppe ALTUNA. // Alcuni modelli che appaiono in questo nuovo catalogo potranno essere ricevuti sia con la marca e il riferimento JMA che con un'altra marca del gruppo ALTUNA.

ÍNDICE GENERAL / GENERAL INDEX / INDEX GENERALE / GESAMTVERZEICHNIS / INDICE GENERALE

REF.	PAG.	REF.	PAG.	REF.	PAG.	REF.	PAG.
A		ALF-36	2	BUR-23D	5	DEK- 9D	9
ABA-1	1	ALP-6	2-21	BUR-24	5	DEK-10	9
ABU-57D	1	ALP-6D	2-21	BUR-24D	5	DEK-11	9
ABU-58D	1	AMA-1	2	BUR-25D	5	DEK-13	9
ABU-63	1	AMA-1D	2	BYP-1D	6	DEK-14D	9
ABU-64P	1	AMG-10	2	C		DEK-1G	28
ABU-65P	1	ANK-65	2	C-2	6	DLC-3	9
ABU-66	1	AP-4D	3	CE-114	6	DMR-6-1	27
ABU-67	1	AR-1D	3	CE-117D	6	DMR-6-1L	27
ABU-67D	1	ARN-1	3	CE-118D	6	DMR-6-2	27
ABU-68	1	ARN-2D	3	CENT-4	6	DMR-6-2L	27
ABU-69	1	ARR-7D	3	CI-13G	26	DMR-6-3	27
ABU-70	1	ARR-9D	3	CI-14G	26	DMR-6-3L	27
ABU-71D	1	AS-25D	3	CI-51	7	DMR-6-4	27
AGA-25	1	ASP-1D	3	CI-51D	7	DMR-6-4L	27
AGA-42	1	AX-2P	21	CI-53	7	DMR-7-1	27
AGA-43	1	AX-3DP	21	CI-55D	7	DMR-7-2	27
AGA-44	1	AZ-29	3	CI-56	7	DMR-7-3	27
AGB-4	2	AZ-32	3	CI-57	7	DMR-7-4	27
AGB-5	2	B		CI-58D	7	DOM-49D	9
AGD-2	2	BAST-4DP	3	CI-59	7	DOM-51	9
AKA-1PG	26	BDA-1	3	CI-60	7	DOM-52	9
ALF- 1	2	BE-10G	26	CI-61	7	DOM-B1	9
ALF- 2	2	BES- 2D	4	CIF-3D	6	E	
ALF- 3	2	BES- 3D	4	CIS-6D	6	EP-1D	10
ALF- 4	2	BES- 4D	4	CLK-1	8	ER-2D	10
ALF- 5	2	BES- 5D	4	CLS-1D	7	ER-3	10
ALF- 6	2	BES- 6D	4	COH-1	7	ER-4D	10
ALF- 7	2	BES- 7D	4	COH-2	7	ER-5G	28
ALF- 8	2	BES- 8D	4	COH-2D	7	EST-5TG	28
ALF- 9	2	BES- 9D	4	COH-3	7	EU-11	10
ALF-10	2	BES-10D	4	COH-4	7	EUB-1	10
ALF-10D	2	BES-11D	4	COR- 1GD	8	EVE-4	10
ALF-11D	2	BES-12D	4	COR-69	8	EXS-1D	10
ALF-12D	2	BES-13D	4	COR-70D	8	F	
ALF-13D	2	BES-14D	4	COR-72	8	FAL-1D	10
ALF-14D	2	BES-15D	4	COR-73	8	FAL-2D	10
ALF-15	2	BES-16D	4	COR-74	8	FAY-1D	11
ALF-16	2	BES-17D	4	COR-77	8	FAY-1X	25
ALF-17	2	BEY-2D	4	COR-78	8	FB-38	10
ALF-18	2	BK-14	4	CR-17TG	26	FB-39	10
ALF-19	2	BM-6P	21	CR-18G	27	FB-41	10
ALF-20	2	BOG-2G	26	D		FI-16C1	24
ALF-21	2	BRI-33	4	DAC-3DC1	21	FM- 4TG	28
ALF-22D	2	BSS-3	4	DAE-3P2	21	FM-20G	28
ALF-23	2	BSS-4D	4	DAF-1	8	FO-24C1	21
ALF-24	2	BUL-1	4	DAF-1D	8	FO-24C2	21
ALF-25	2	BUL-2D	4	DAF-2	8	FTH-23	11
ALF-26	2	BUL-3D	4	DAF-3D	8	FTH-24	11
ALF-27	2	BUL-4D	5	DAF-4D	8	FTH-25	11
ALF-28	2	BUL-5D	5	DAT- 6C1	23	FTH-26D	11
ALF-29	2	BUL-6D	4	DAT-15C1	23	FTH-27	11
ALF-30	2	BUL-7D	5	DEK- 4	9	FTH-28	11
ALF-31	2	BUR- 3	5	DEK- 6D	9	FTH-29	11
ALF-32D	2	BUR- 9	5	DEK- 7D	8		
ALF-33	2	BUR-10	5	DEK- 8	9		
ALF-34	2	BUR-14	5				
ALF-35	2	BUR-17	5				

ÍNDICE GENERAL / GENERAL INDEX / INDEX GENERALE / GESAMTVERZEICHNIS / INDICE GENERALE

REF.	PAG.	REF.	PAG.	REF.	PAG.	REF.	PAG.
G		IT-1TG	29	O		TE -T11	18
GARD-1G	28	IT-4G	29	OJ-18P	16	TE -T62	18
GDA- 1P	11	J		OJ-19	16	TEI-1D	18
GDA- 3D	12	JGH-1D	13	OMC-5D	16	TIF- 2D	18
GDA-30D	12	K		OP-11C1	22	TIF-15/20	18
GDA-50D	12	KAE- 1G	29	OP-WHC1	22	TIF-25D	18
GDA-60D	12	KAE-11D	13	P		TIF-30D	18
GE-15D	11	KNA-1D	14	PEU-1C1	24	TIF-40D	18
GE-16D	11	KYM-2	22	PEU-2C1	24	TIF-50/60	18
GEA-3X	25	KYM-2D	22	PFA-6	16	TIG-1D	18
GEA-5D	11	KYM-2DP	22	PFA-6D	16	TIT-14	18
GG-1D	21	KYM-2P	22	PGO-2P	23	TIT-14D	18
GIM-1TG	28	L		PHO-1	16	TIT-15	19
GLA-2D	12	LAP-88	14	PTN- 1D	16	TIT-15D	19
GM-42	21	LB-2DP	14	PTN-13TG	29	TIT-16D	19
GMT-1	11	LB-4D	14	R		TIT-17	19
GMT-2	11	LCK-1X	25	RE-2	16	TIT-18D	19
GMT-3D	11	LF-20D	14	RE-4D	16	TOK-32	19
GMT-4D	11	LF-36	15	RE-5D	16	TOK-34D	19
GMT-5D	11	LF-37D	15	RIT-1D	16	TOYO-30P1	24
GRG-1	12	LF-38D	15	RO-38	17	TRO-1	17
GTV-5D	12	LF-39D	23	RO-38D	17	U	
H		LF-40	14	RO-40	17	U- 5BD	19
HAF-2	12	LIP-1GD	14	RO-40D	17	U- 5KD	19
HEL-1	12	LIT-7D	14	ROSE-1	17	U- 5KI	19
HEN-2	12	LWO-2	14	ROY-1	17	U- 5QD	19
HOB-1	12	LWO-7D	14	RST-1	4	U- 5QI	19
HOB-2D	13	LWO-8	14	RUB-7G	30	U- 5SD	19
HRM-1	12	LWO-9	14	RUB-8G	30	U- 5SI	19
HT-1	13	M		RUB-9G	30	U- 5SP	19
HU-HAAC1	21	MAS-22D	15	S		U- 6BD	19
HU-HAAC2	22	MASL-1	15	SAM-5G	30	U-15GD	19
HU-HAAC3	24	MAZ-21DP1	23	SCC-1D	17	U-15GI	19
HU-HAAC4	24	MCM-26	15	SHI-3D	17	U-17	19
HU-NAAC2	22	MCM-29D	15	SIA-2G	30	U-22	20
HY- 4P3	22	MER-19D	15	SIA-3G	30	U-22D	20
HY-11DP1	22	MER-20D	15	SQ-5D	17	U-25	20
HY-11DP3	22	MER-21D	15	SQ-6	17	U-25D	20
HY-11P3	22	MERI-1D	23	SQ-7	17	URB-3D	20
HY-12P3	22	MI-5D	15	SQ-8D	17	V	
I		MLM-6	15	STR-5	17	VI-14	20
IF-4	13	MLM-7	15	SUB-2P	23	W	
IF-5	13	MSM-1	16	SUZU- 7DP	23	WIL-22	20
IF-6	13	MSM-2D	16	SUZU-14P2	23	WIR-1	20
IF-I51	13	MSV-1X	25	T		WM-5D	20
IMS-13	23	MT-2G	29	TAT-1D	23	Y	
IMS-13P	23	MT-2TG	29	TAT-1DP	24	YA-72	20
ING-M	13	MTL-1D	15	TAT-2D	24	YA-79D	20
IS- 1X	25	MTL-1G	29	TAT-2DP	24	YA-81	20
IS- 6G	29	MUL-T10P	16	TE -28	18		
IS-10	13						
IS-15	13						
IS-16D	13						
ISU-3DP	22						

ÍNDICE POR MARCAS / INDEX MAIN / INDEX MARQUE / HAUPTMARKE / INDICE MARCA

REF.	PAG.	REF.	PAG.	REF.	PAG.
A		D		I	
ABA	1	DACIA	21	I.R.	20
ABSA	6	DAEWOO	21	IFAM	13
ABUS	1	DAF	8	INGERSOLL	13
AGA	1	DAR-MAR	27	ISEO	13-25-28
AGB	2	DEKABA	8-9-28	ISUZU	22
AGC	2	DELCA	9	ITAL	29
AKARSAN	26	DOBLE G	21		
AL	2	DOM	9	J	
ALFA	2	DRAPER	20	JOWIL	12
ALPHA	2-21			JUNGHEINRICH	13
AMARU	2	E		K	
AMIG	2	EFER	6	KALE	13-29
ANKER	2	EP PINSON	10	KYMCO	22
APEX	3	ERA	10-28	KYNNARPS	14
ARMSTRONG	3	ESETY	28		
ARREGUI	3	EURO BOX	10	L	
ARROW	3	EURO LOCKS	10	LAPERCHE	14
ASPA	3	EUROPROFIL	12	LEN-LOK	14
ASSA	3	EVERGOOD	10	LIPS	14
ATLANTIC	11	EXPRES	10-11-14	LITTO	14
ATRA	13			LOB	14
AXA	21	F		LOCK-IT	25
AZBE	3	FAB	10	LOCKWOOD	14
		FALCON	4-10	LOWE & FLETCHER	14-15-23
		FAYN	11-25		
B		FEB	2-21	M	
BANE SEKULIC	4-20	FIAM	28	MASTER	15
BAODEAN	3	FICHET	14-19	MASTER LOCK	15
BASTA	3	FTH	3-11	MAUER	8-9
BEST	4			MAZDA	23
BETA	26	G		MCM	15
BEY	4	GAMMET	11	MERIT LINDE	23
BIFFAR	19	GARDIAN	28	MERONI	15
BKS	4	GE GE	2-11	METAL	15-29
BODA	30	GENERAL MOTORS	21	MILA	15
BOGATIR	26	GERA	11-25	MLM	15
BOULTON & PAUL	4	GERDA	11-12	MOTTURA	29
BRICARD	4-14	GEVY	9	MSM	16
BSS	4	GIMAST	28	MSV	25
BULAT	4-5	GLAZIEV	12	MULTLOCK	16
BURG	5	GR	12		
BYP	6	GTV	12	N	
				NEMEF	6
C		H		NISSAN	23
CAM	30	HÄFELE	12		
CARTERO	6	HELIX	12	O	
CAS CISMA	6	HENDERSON	12	OJMAR	16
CENTURY	6	HERME	12	OMEC	16
CES	6	HOBES	12-13		
CIFIAL	6	HTV	13		
CISA	7-26	HUF	21-22		
CLASSIC	7	HYUNDAI	22		
COHNKO	7				
CORBIN	8-9				
CR	26-27				
CRAZY LOCKS	8				

ÍNDICE POR MARCAS / INDEX MAIN / INDEX MARQUE / HAUPTMARKE / INDICE MARCA

REF.	PAG.	REF.	PAG.
P		V	
PFÄFFENHAIN	16	VALEO	23-24
PGO	23	VAUGHN	13
PHOENIX	16	VIRO	20
PICARDIE	19		
POTENT	16-29	W	
PZ	4	WEISER	10
		WILKA	20
R		WIREROPE	20
REDY	14	WMS	20
RENZ	16		
RITA	16	Y	
RONIS	17	YALE	4-20
ROSSETTI	17	YETI	14
ROTO	11		
ROYAL	17		
RST	4		
RUBEN	30		
S			
SAFE	23		
SAM	30		
SCHUCO	17		
SHILUTE	17		
SIAS	30		
SONICO	7		
SP	11		
SQUIRE & S.	17		
STREBOR	17		
STS	9		
SUBARU	23		
SUZUKI	23		
T			
TARONI	17		
TATA	23-24		
TEICOCIL	18		
TESA	18		
TIEFENTHAL	12		
TIFON	18		
TIGRIS	18		
TITAN	18-19		
TITUS	20		
TOK WINKHAUS	19		
TOYOTA	24		
TRINITY	15		
TRW-SIPEA	24		
U			
UNIVERSAL	19-20		
URBIS	20		



Tél. 04 73 84 84 94

PARA:
FOR: ABA

ABUS

PARA-FOR:

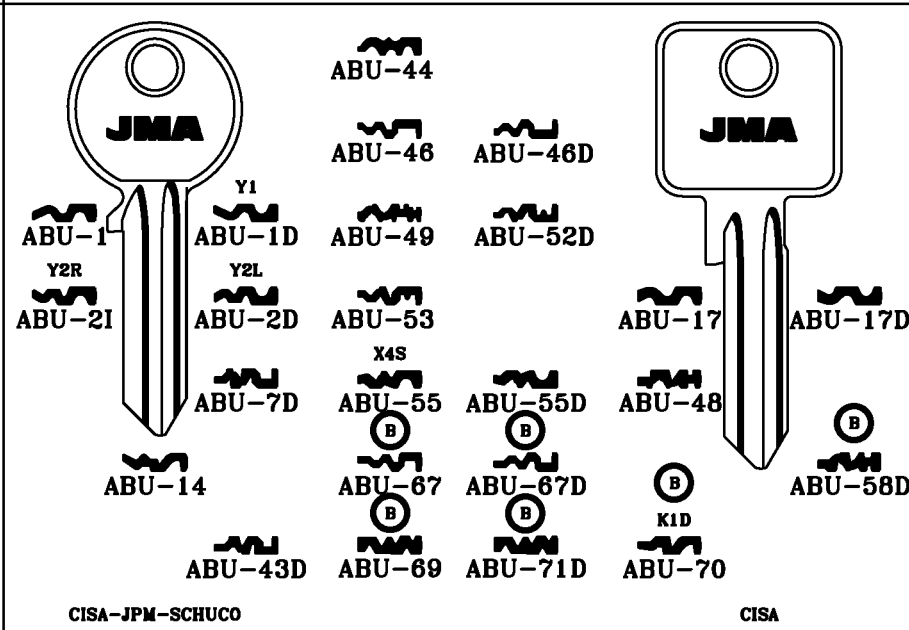
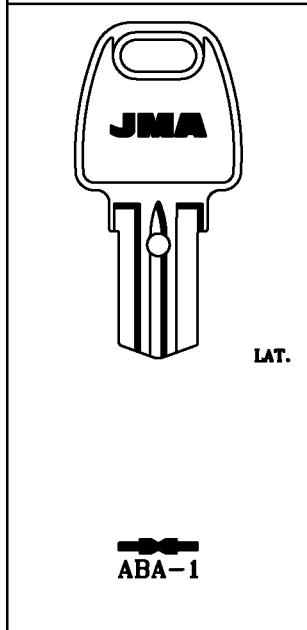

ABA (SF)
ABUS (D)
AGA (E)

PARA:
FOR: ABUS

ABUS

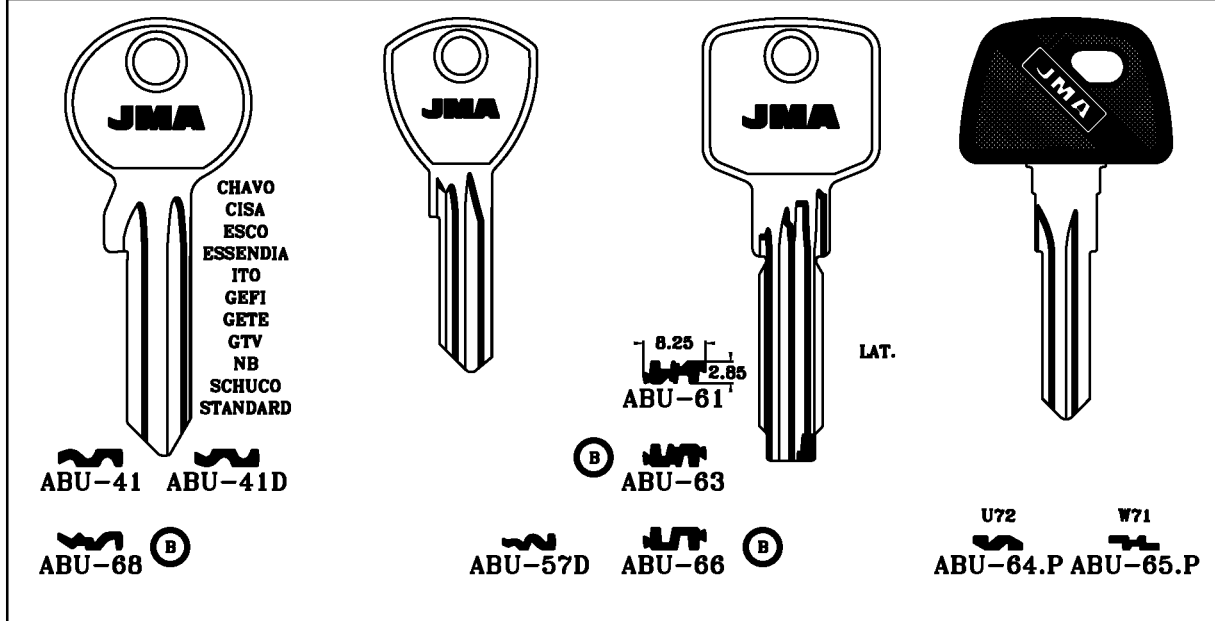

PARA:
FOR: AGA

AGA

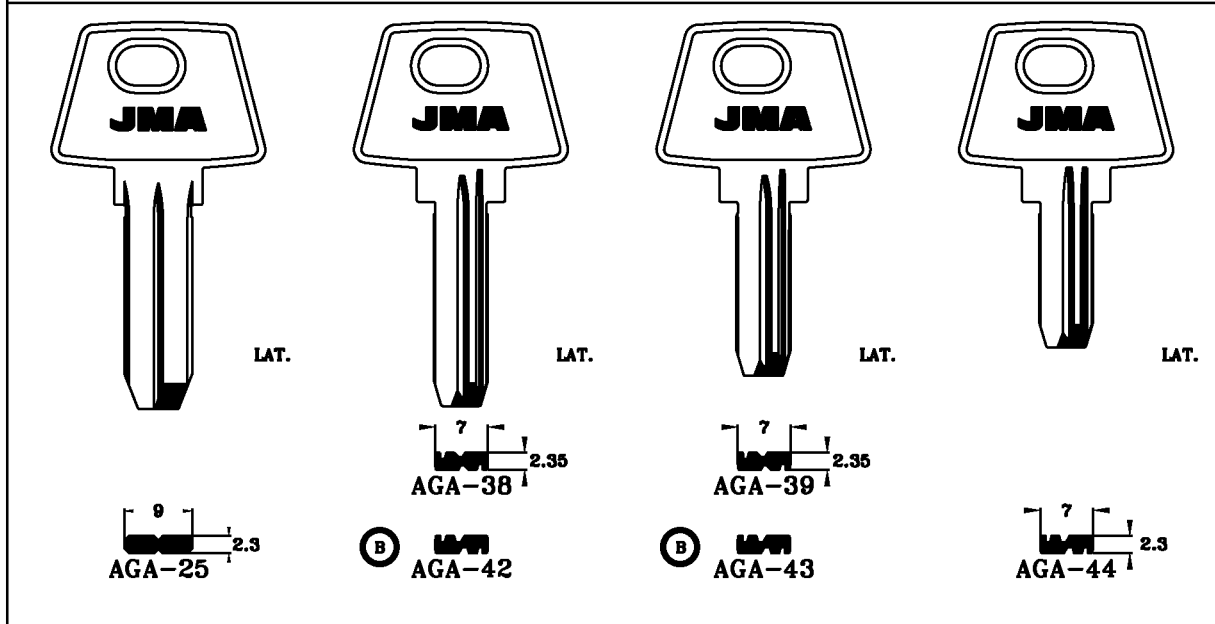



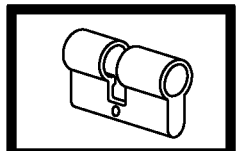

Copyright by
Alejandro Altuna S.A.
2009



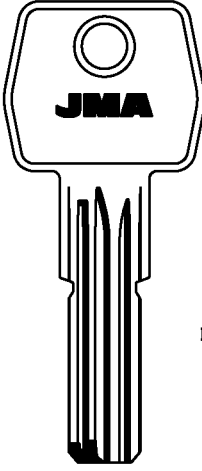
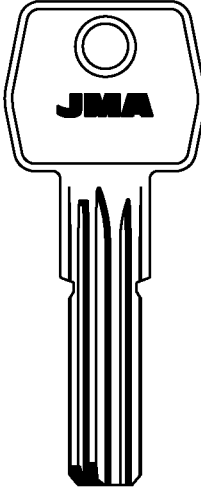
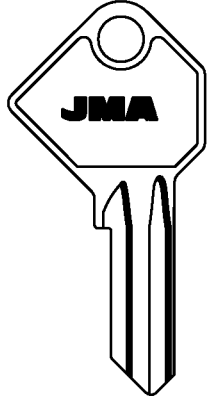







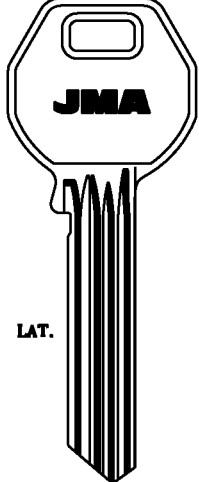

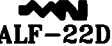





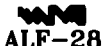





























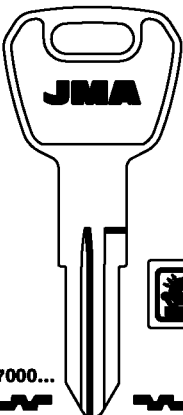

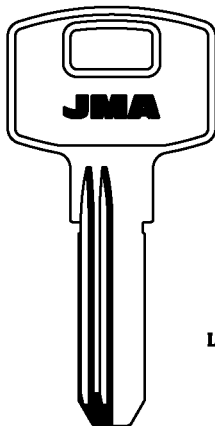
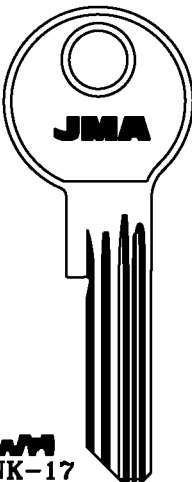
1

PARA-FOR:

PARA: FOR:	AGB	AGC
	 	
	LAT.	LAT.
	 AGB-4 SCUDO 5000	 AGB-5 SCUDO 5000
		 AGD-2

- AGB (I)**
- AGC (P)**
- ALFA (S)**
- ALPHA (J)**
- AMARU (P)**
- AMIG (E)**
- ANKER (NL)**

PARA: FOR:	ALFA				
 LAT.	 ALF-8	 ALF-15	 ALF-22D	 ALF-29	 ALF-36
	 ALF-7	 ALF-14D	 ALF-21	 ALF-28	 ALF-35
	 ALF-6	 ALF-13D	 ALF-20	 ALF-27	 ALF-34
	 ALF-5	 ALF-12D	 ALF-19	 ALF-26	 ALF-33
	 ALF-4	 ALF-11D	 ALF-18	 ALF-25	 ALF-32D
	 ALF-3	 ALF-10	 ALF-10D	 ALF-17	 ALF-24
	 ALF-1	 ALF-2	 ALF-9	 ALF-16	 ALF-23
				 ALF-31	
				 ALF-30	
				GE GE	

PARA: FOR:	ALPHA	AMARU	AMIG	ANKER
	 LAT.		 LAT.	
	7000...  ALP-2  ALP-2D JD-LINCE-MONACOR SANY-VISONIC S...301-600  (B)  ALP-6 ALP-6D FEB	 AMA-1  AMA-1D AL	 AMG-10  AMG-10D 4900	 ANK-17  (B) ANK-65

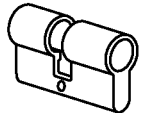

Copyright by
Alejandro Altuna S.A.
2009

JMA

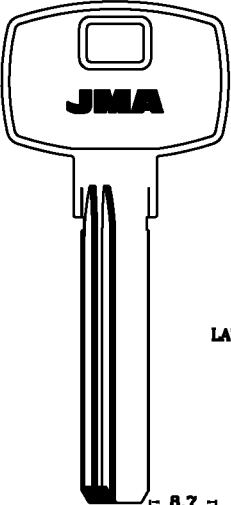
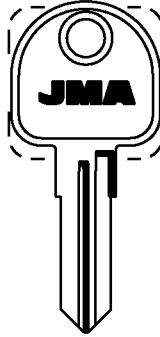
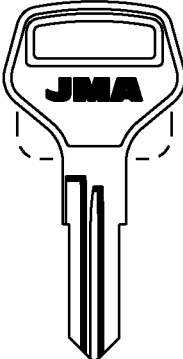

2

ATENCION:Concerniente a las marcas y denominaciones comerciales ver nota en indice.ATTENTION:Concerning the marks and commercial denominations see note in index.
ATTENTION:Concernant les marques et denominations commerciales voir la note dans l'index.ACHTUNG:Beziehen auf die marke und handelsname sehen sie die notiz im index.

PARA: FOR: APEX	ARMSTRONG		ARREGUI
 <p>LAT.</p> <p>8.7 2.35 AP-4D</p> <p>FTH</p>	 <p>ARN-1</p>	 <p>ARN-2D</p>	 <p>AR-1D</p>

PARA-FOR:

- APEX (RUS)
- ARMSTRONG (USA)
- ARREGUI (E)
- ARROW (USA)
- ASPA (NL)
- ASSA (S)
- AZBE (E)
- BAODEAN (TJ)
- BASTA (IRL)

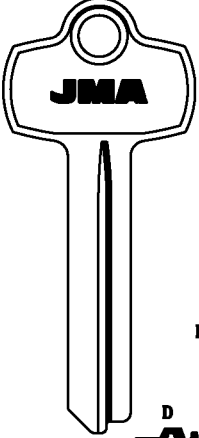
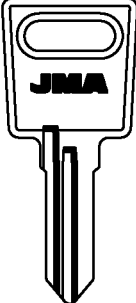
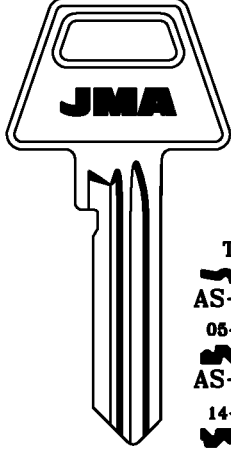
PARA: FOR: ARROW	ASPA	ASSA	
 <p>LAT.</p> <p>D ARR-7D</p> <p>C ARR-9D</p>	 <p>ASP-1D</p>	 <p>TL AS-4D</p> <p>05-04 AS-5D</p> <p>14-01 AS-6D</p> <p>05-13 AS-7D</p> <p>14-09 AS-8D</p> <p>14-25 AS-9D</p> <p>05-05 AS-10D</p> <p>11-14 AS-12D</p> <p>11-01 AS-13D</p> <p>11-12 AS-14D</p> <p>11-32 AS-15D</p> <p>11-08 AS-18D</p> <p>05-14 AS-18D</p> <p>TM AS-25D</p> <p>ⓑ</p>	

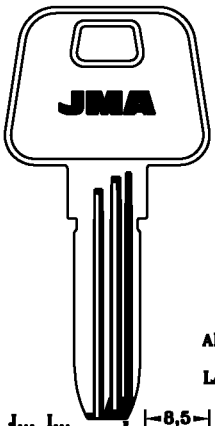
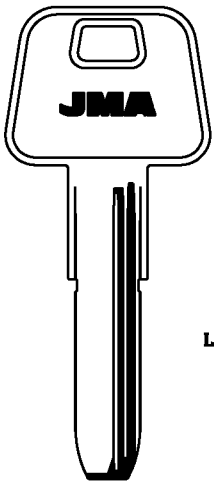
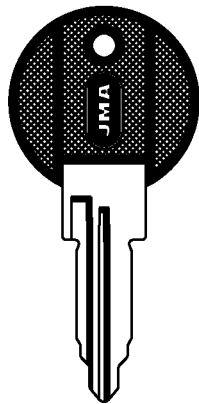
PARA: FOR: AZBE	BAODEAN	BASTA	
 <p>ALP. LAT.</p> <p>J... 1... 8,5 2.35 AZ-9 AZ-9D</p> <p>2... 3... AZ-12 AZ-29 ⓑ</p> <p>CAVERS-CENTURION-ZAIN</p>	 <p>LAT.</p> <p>BDA-1</p>	 <p>LAT.</p> <p>BAST-4D.P</p>	

Copyright by
Alejandro Aituna S.A.
2009

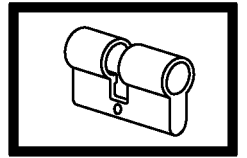

ATENCION:Concerniente a las marcas y denominaciones comerciales ver nota en indice.ATTENTION:Concerning the marks and commercial denominations see note in index. ATTENTION:Concernant les marques et denominations commerciales voir la note dans l'index.ACHTUNG:Beziehen auf die marke und handelsname sehen sie die notiz im index.

PARA-FOR:

BEST (USA)

BEY (TR)

BKS (D)

BOULTON & PAUL (GB)

BRICARD (F)

BSS (YU)

BULAT (RUS)

PARA: FOR:	BEST	BEY	BKS
	<p>LAT.</p> <p>Q BES-12D</p> <p>R BES-13D</p> <p>L BES-10D</p> <p>M BES-11D</p> <p>J BES-8D</p> <p>K BES-9D</p> <p>TB BES-17D</p> <p>G BES-6D</p> <p>H BES-7D</p> <p>F BES-16D</p> <p>DD BES-4D</p> <p>E BES-5D</p> <p>FM BES-15D</p> <p>A BES-1D</p> <p>C BES-2D</p> <p>D BES-3D</p> <p>B BES-14D</p> <p>FALCON</p>	<p>LAT.</p> <p>8.9 BEY-2D</p>	<p>BK-14</p> <p>PZ-YALE</p>

PARA: FOR:	BOULTON	BRICARD	BSS
	<p>RST-1</p> <p>RST</p>	<p>LAT.</p> <p>8.2 2.63 BRI-26</p> <p>3.5 BRI-28</p> <p>2.85 BRI-29</p> <p>3.5 BRI-31</p> <p>3.5 BRI-33</p>	<p>BSS-3</p> <p>BANE SEKULIC</p>

PARA: FOR:	BSS	BULAT		
	<p>BSS-4D</p> <p>BANE SEKULIC</p>	<p>LAT.</p> <p>9 2.5 BUL-1</p>	<p>BUL-2D</p> <p>BUL-6D</p>	<p>BUL-3D</p>

Copyright by
Alejandro Altuna S.A.
2009

JMA

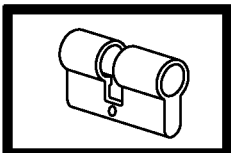

4

PARA:
FOR:

BULAT

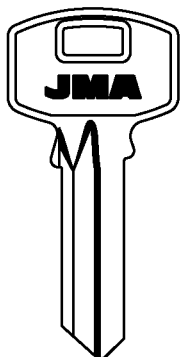

BUL-4D

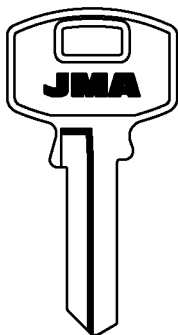

BUL-5D

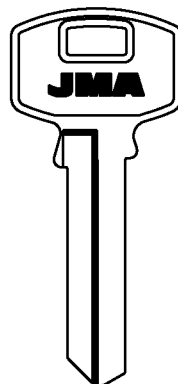

BUL-7D

PARA-FOR:

BULAT (RUS)

BURG (D)

PARA:
FOR:

BURG

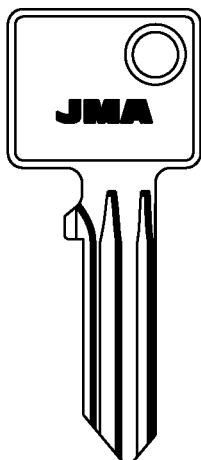

BUR-3
 BUR-3D

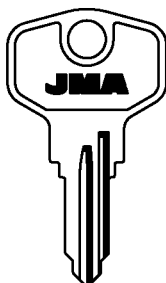

BUR-9
 BUR-9D
ATL-BURGWACHTER-BUVA-HEWY
DURABLE-HOPPE-RITTAL-WSM

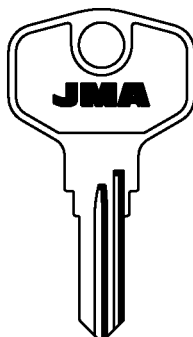

BUR-10
 BUR-10D
CIBOX-HOPPE-KIND-ROTO

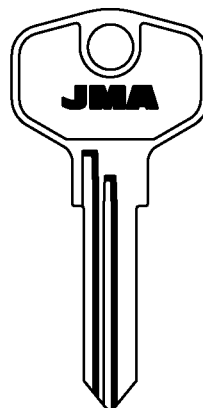

BUR-11D
 BUR-23D

ANKE-BURG WACHTER

PARA:
FOR:

BURG



BUR-14
 BUR-14D
 BUR-19D
222 C40

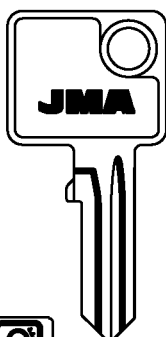

BUR-17
 BUR-17D
 BUR-20D
222 C30

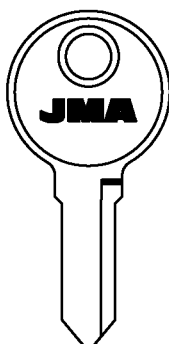

BUR-24
 BUR-24D

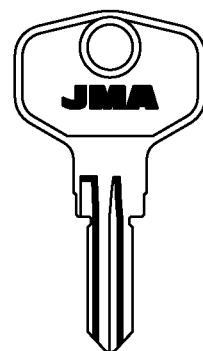

BUR-25D

Copyright by
Alejandro Altuna S.A.
2009

JMA

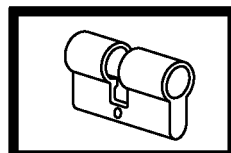

5

PARA-FOR:

PARA-FOR:	BYP	CARTERO	CAS-CISMA	CENTURY
BYP				
CARTERO (E)				
CAS-CISMA (I)				
CENTURY (GB)				
CES (D)				
CIFIAL (P)				
	LAT. BYP-1D	ABS C-2	LAT. CIS-6D	 CENT-4

PARA-FOR:	CES					
	X23 CE-9D	X30 CE-16D	X37 CE-23D	W24 CE-30D	W31 CE-37D	
	X24 CE-10D	X31 CE-17D	X38 CE-24D	W25 CE-31D	W32 CE-38D	W38 CE-44D
	X25 CE-11D	X32 CE-18D	X39 CE-25D	W26 CE-32D	W33 CE-39D	W39 CE-45D
	X26 CE-12D	X33 CE-19D	X40 CE-26D	W27 CE-33D	W34 CE-40D	W40 CE-46D
	X27 CE-13D	X34 CE-20D	X41 CE-27D	W28 CE-34D	W35 CE-41D	W41 CE-47D
	X28 CE-14D	X35 CE-21D	X42 CE-28D	W29 CE-35D	W36 CE-42D	W42 CE-48D
	X29 CE-15D	X36 CE-22D	W23 CE-29D	W30 CE-36D	W37 CE-43D	CE-118D ^(B)
	SOLID					

PARA-FOR:	CES	CIFIAL
	 CE-117D ^(B)	
	 CE-111D	
	 CE-105	
	 CE-104D	
	 CE-103	
	 CE-102	
	LAT. CE-114	
	NEMEF	EFER CIF-3 ^(B) CIF-3D ^(B)

Copyright by
Alejandro Altuna S.A.
2009

JMA

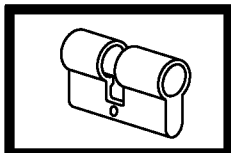

6

PARA:
FOR:

CISA

PARA-FOR:

CISA (I)

CLASSIC

СОНИКО (RUS)

ABUS
ESCO
ESSENDIA
GEFI
GETE
GTV
SCHUCO
STANDARD

*MTIC.
ABUS
CHAVO
ESCO
ESSENDIA
ITO
GEFI
GETE
GTV
NB
SCHUCO
STANDARD

LAT.

CI-31
CI-32
CI-33
CI-25
CI-26
CI-30

CI-21
CI-35
CI-56
CI-59

CI-60
CI-49
CI-51
CI-55D
CI-61

CI-61
*CI-6D
CI-58D

CI-21
CI-2
CI-9D
CI-11D
CI-13
CI-15
CI-18
CI-29
CI-27

CI-2
CI-8D
CI-10D
CI-12
CI-15D
CI-16D

CI-34
CI-36
CI-38D
CI-42
CI-53

CI-57

CI-IL
*CI-DL

CI-51D
R033
CI-55D
R032
CI-61

ABUS-ASTRAL-AXIS

PARA:
FOR:

CISA

CLASSIC

ALU.
COL.
*FSH.

ABUS
ESCO
ESSENDIA
GEFI
GETE
GTV
NB
SCHUCO
STANDARD

LAT.

CI-21
CI-9D
CI-11D
CI-13
CI-15
CI-18
CI-29
CI-27

CI-2
CI-8D
CI-10D
CI-12
CI-15D
CI-16D

CI-34
CI-36
CI-38D
CI-42
CI-53

CI-57

CI-IL
*CI-DL

CI-51D
R033
CI-55D
R032
CI-61

CLASSIC

CLS-1D

PARA:
FOR:

СОНИКО

COH-1
COH-2
COH-2D
SONICO

COH-3
SONICO

COH-4

Copyright by
Alejandro Aituna S.A.
2009

JMA

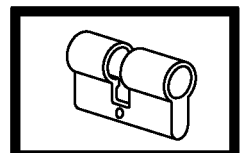



7

PARA-FOR:

PARA:
FOR:

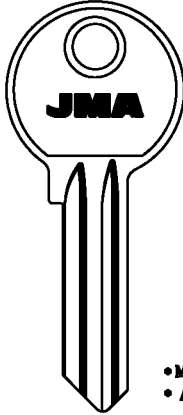

CORBIN

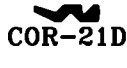
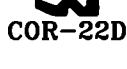
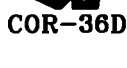
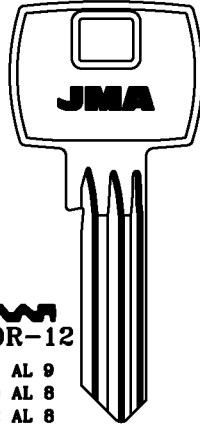
- CORBIN (I)**
- CRAZY LOCKS (RC)**
- DAF (TR)**
- DEKABA (BG)**

	ALUNORM CRC-CAMBOA DOM ESCO EURONORM HEGO HESTE ISSERSTEDT KAVE LITTO MERMIER MUKRA NEMEF NOVOFERM STREMLER SUL THONE VERSCO ZECE						
EUROPARTNER							

PARA:
FOR:

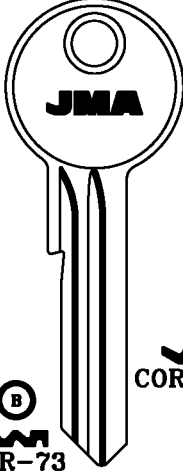
CORBIN

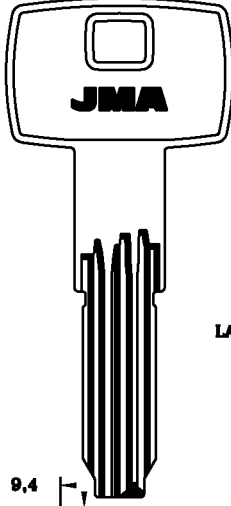
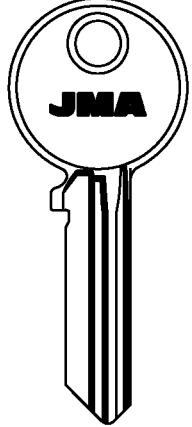
			
(B) COR-73 COR-74 (B)	COR-15D	9,4 2,9 COR-70D COR-77 ¹	LAT. COR-78

PARA:
FOR:

CRAZY L.

DAF

DEKABA

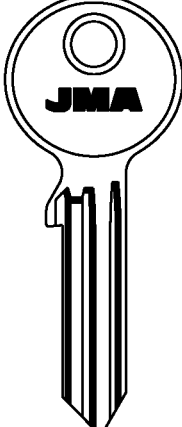
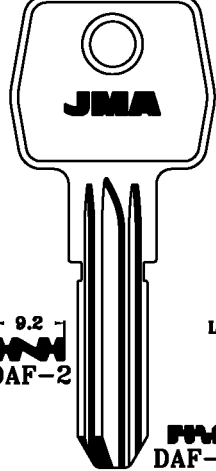
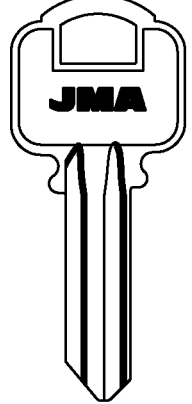
			
CLK-1	DAF-1 DAF-1D	9,2 2,8 DAF-2 DAF-3D DAF-4D	DEK-2 (B) DEK-7D MAUER

Copyright by
Alejandro Altuna S.A.
2009

JMA

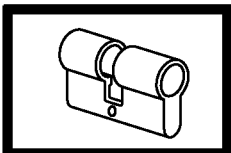

8

PARA:
FOR:

DEKABA

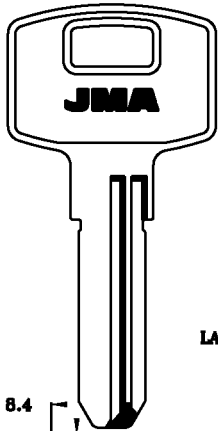

DEK-3



MAUER

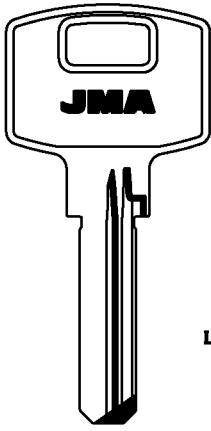

DEK-4

MAUER

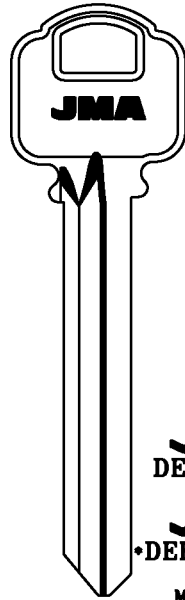

DEK-6D

DEK-14D

MAUER

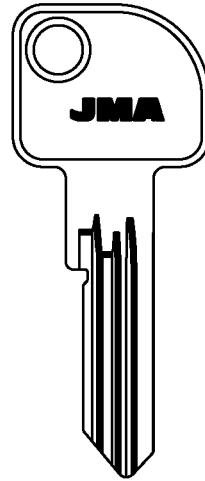

DEK-9D

MAUER

LAT.

LAT.

LAT.

PARA:
FOR:

DEKABA

DELCA

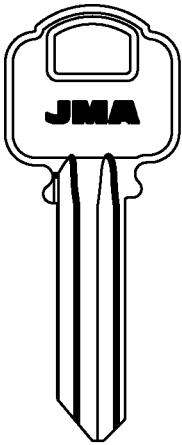

DEK-10

DEK-11

MAUER

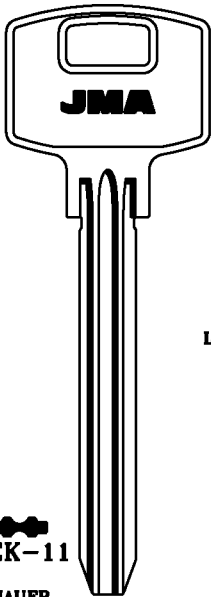

LAT.

DEK-13

MAUER

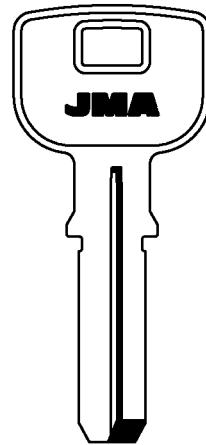

DLC-3

GEVY

LAT.

PARA:
FOR:

DOM

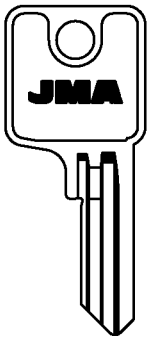

DOM-25D

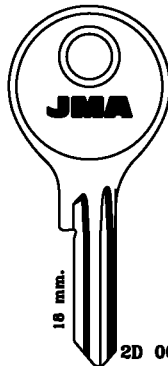

DOM-35 DOM-35D

2D 001-222
5A 0001-2800
9A 0001-5200
1D 601-654

DOM-49D

DOM-51

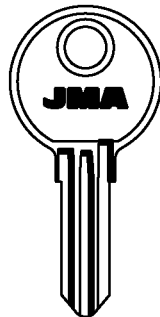

DOM-52

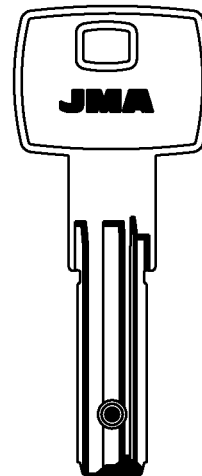

DOM-B1

CORBIN-ST5

ALP.

Copyright by
Alejandro Altuna S.A.
2009

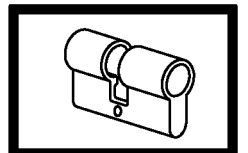

9

ATENCION:Concerniente a las marcas y denominaciones comerciales ver nota en indice.ATTENTION:Concerning the marks and commercial denominations see note in index. ATTENTION:Concernant les marques et denominations commerciales voir la note dans l'index.ACHTUNG:Beziehen auf die marke und handelsname sehen sie die notiz im index.

PARA-FOR:

DEKABA (BG)

DELCA (GR)

DOM (D)

PARA-FOR:

**EP PINSON
(GB)**

ERA (GB)

EURO BOX









**EUROLOCKS
(B)**

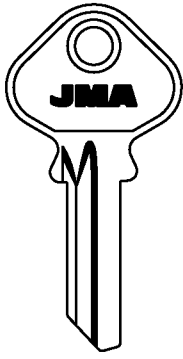

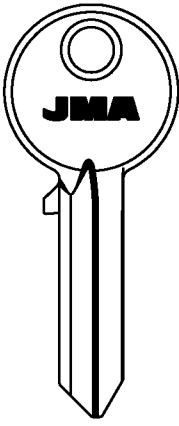

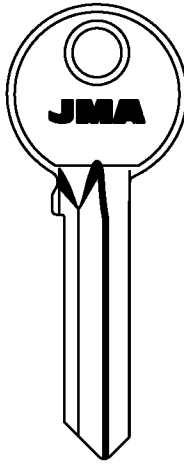

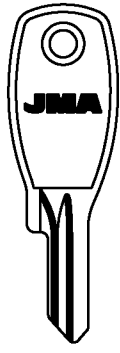

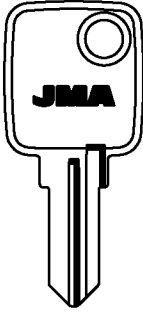

**EVERGOOD
(RC)**

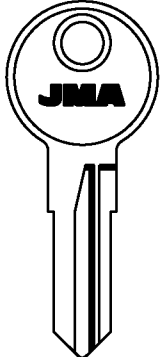



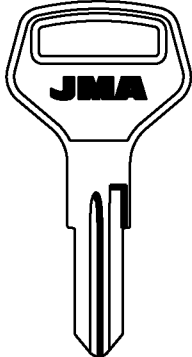

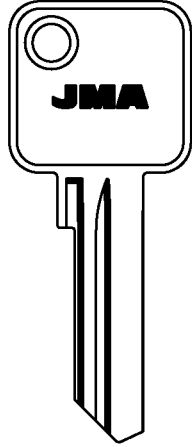
EXPRES (PL)

FAB (CZ)

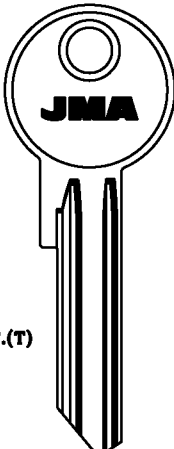
FALCON (USA)

PARA: FOR: EP PINSON	ERA		
 	 	 	 

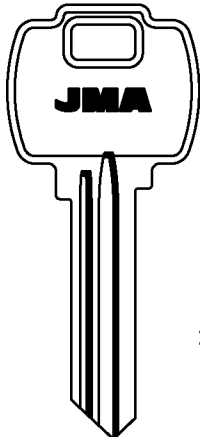
PARA: FOR: EURO BOX	EUROLOCKS	EVERGOOD	EXPRES
 	   	 	 

PARA: FOR:	FAB	FALCON
 	 	  

• MTIC.(T)

PR23
FB-14

PR24
FB-15

PR22
• FB-13

PR30
• FB-17

PR32
FB-18

PR20
• FB-27

PR26
FB-16

PR21
FB-28

10X
FB-32

12X
FB-34

11X
FB-35

K
FB-38

14X
FB-41

Copyright by
Alejandro Altuna S.A.
2009

JMA

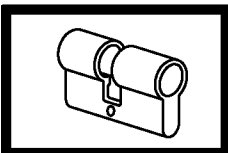

10

PARA: FAYN
FOR:

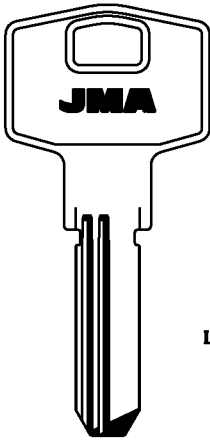

LAT.

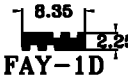

FAYN-1D

FTH

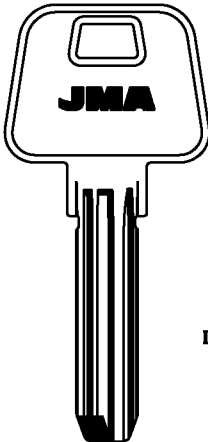

LAT.

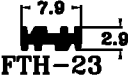

FTH-23

ATLANTIC

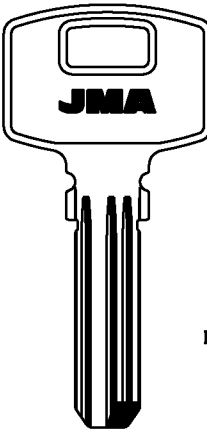

LAT.

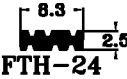

FTH-24

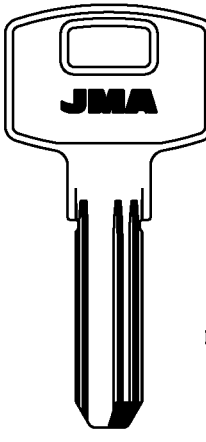

LAT.

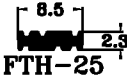

FTH-25

PARA-FOR:

FAYN (RC)
FTH (F)
GAMMET (PL)
GE GE (A)
GERA (D)
GERDA (PL)

PARA: FTH
FOR:

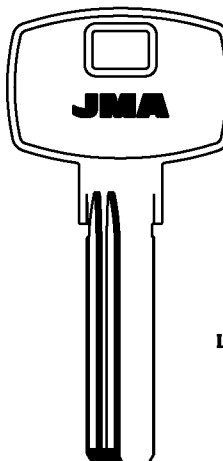

LAT.

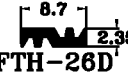

FTH-26D

SP

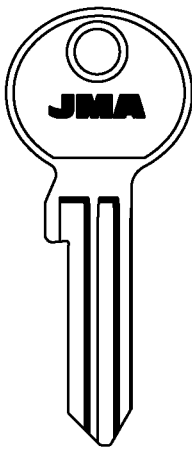

FTH-27

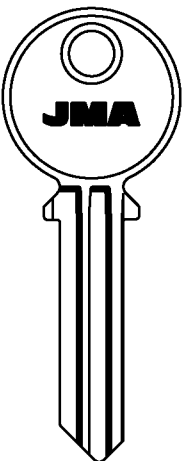

FTH-28

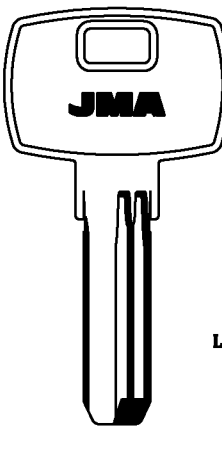

LAT.

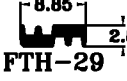

FTH-29

PARA: GAMMET
FOR:

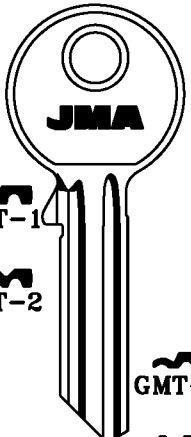

GMT-1



GMT-2

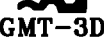

GMT-3D



GMT-4D



GMT-5D

EXPRES

GE GE

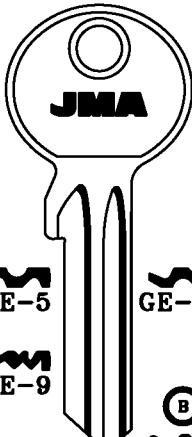

GE-5



GE-5D



GE-9



GE-15D



GE-16D

GERA

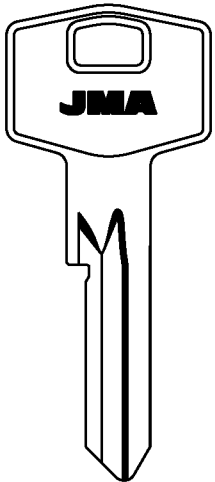

GEA-5D

ROTO

GERDA

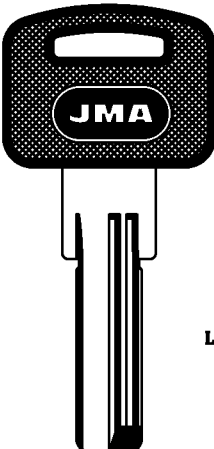

LAT.



GDA-1.P

Copyright by
Alejandro Altuna S.A.
2009

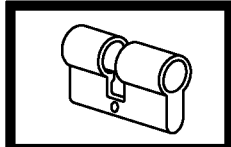
11

PARA-FOR:

PARA:
FOR:

GERDA

GERDA (PL)

**GLAZIEV
(RUS)**

GR (RC)

GTV (D)

HÄFELE (D)

HELIX

**HENDERSON
(USA)**

HERME (RC)

HOBES (RCZ)

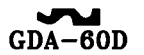
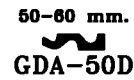
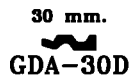
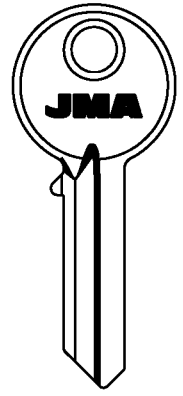
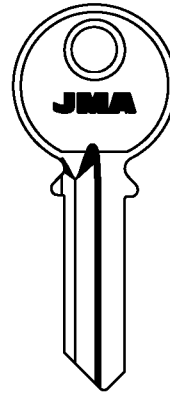
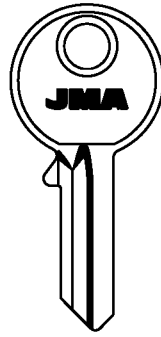
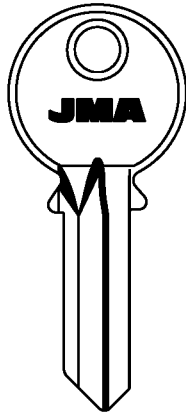

EUROPROFIL

EUROPROFIL

EUROPROFIL

PARA:
FOR: **GLAZIEV**

GR

GTV

HÄFELE

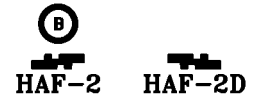
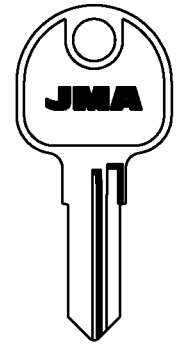
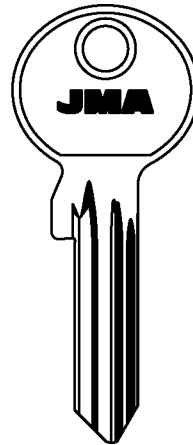
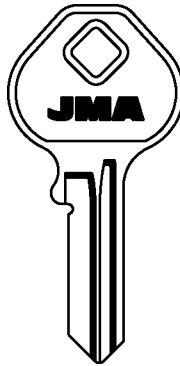
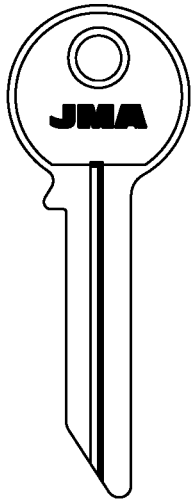

JOWIL-TIEFENTHAL

PARA:
FOR: **HELIX**

HENDERSON

HERME

HOBES

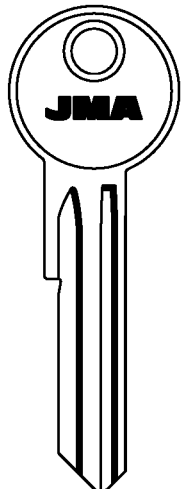
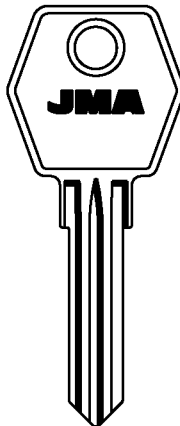
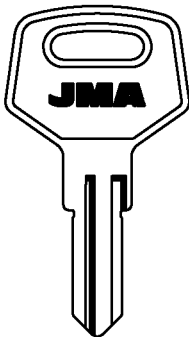

Copyright by
Alejandro Altuna S.A.
2009

JMA

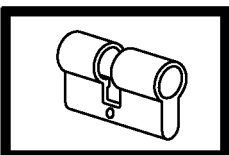



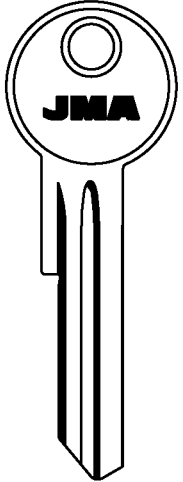
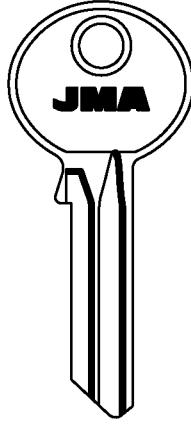
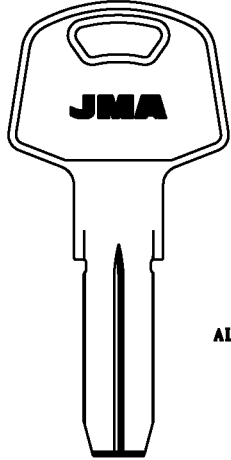
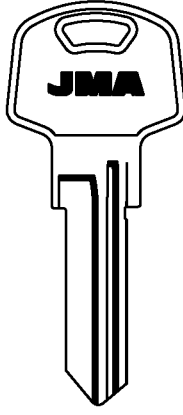

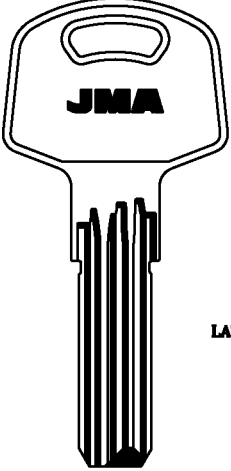
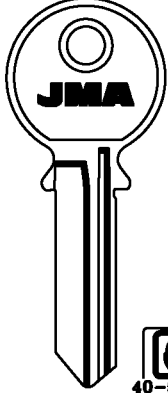

12

PARA: FOR: HOBES	HTV	IFAM	
 HOB-2D	 07 HT-1 VAUGHN	 ALP. 9 IF-4 2.3	 IF-5

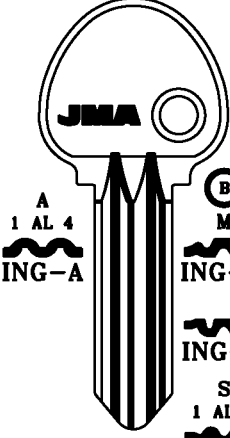
PARA-FOR:

- HOBES (RCZ)**
- HTV (GB)**
- IFAM (E)**
- INGERSOLL (USA)**
- ISEO (I)**
- JUNGHEINRICH (D)**
- KALE (TR)**

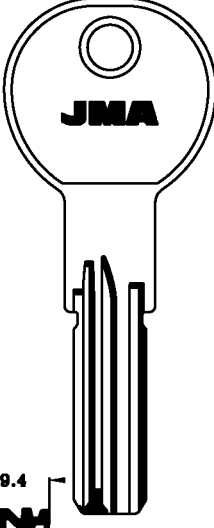
PARA: FOR: IFAM	INGERSOLL	ISEO	
 IF-6 9.4 2.9  IF-150  IF-45/55  IF-151 •ALU. •LAT. •FSH. 40-50-55 50° B	 A 1 AL 4 ING-A  B M ING-M  ING-N  S 1 AL 4 ING-S  W ING-W	 IS-10 9.4 2.65 ATRA	

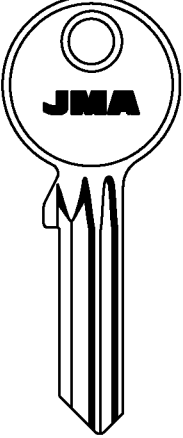
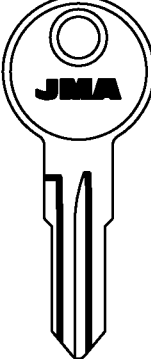
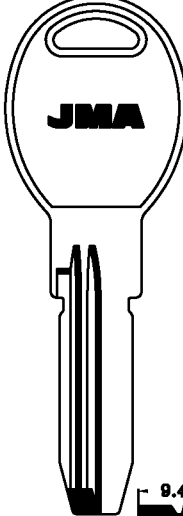
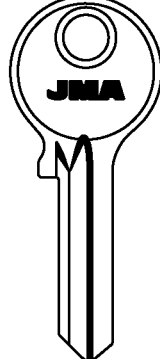

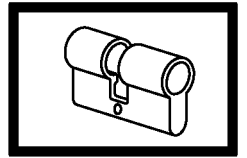

PARA: FOR: ISEO	JUNGHEINRICH	KALE	
 F3 IS-15	 JGH-1D	 LAT. 9.4 2.5 KAE-11D	 IS-16D





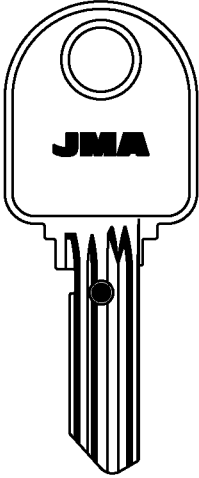
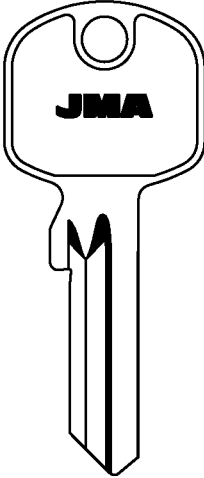
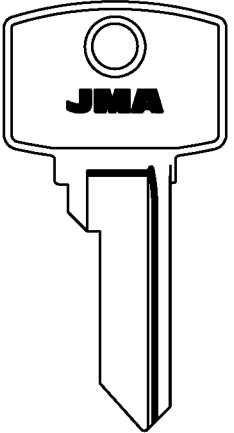

Copyright by
Alejandro Altuna S.A.
2009



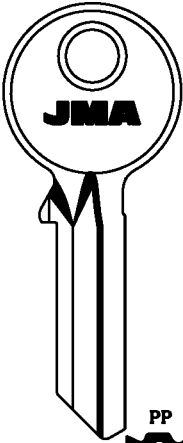
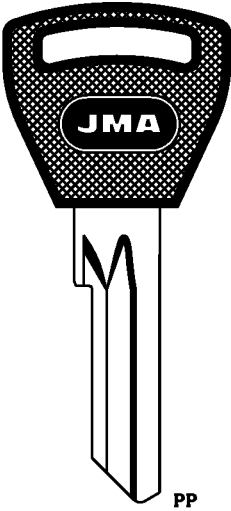
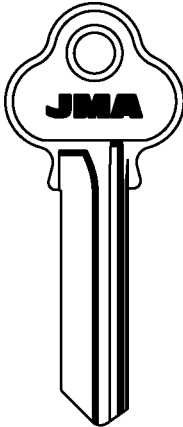
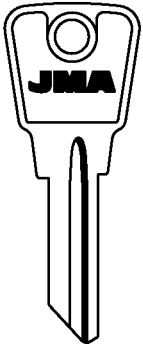





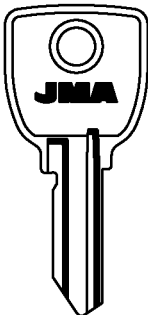
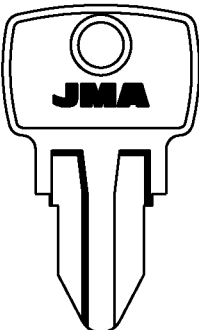
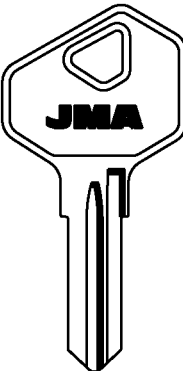
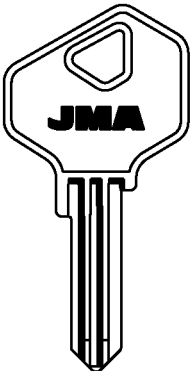

ATENCION:Concerniente a las marcas y denominaciones comerciales ver nota en indice.ATTENTION:Concerning the marks and commercial denominations see note in index. ATTENTION:Concernant les marques et denominations commerciales voir la note dans l'index.ACHTUNG:Beziehen auf die marke und handelsname sehen sie die notiz im index.

PARA-FOR:

PARA-FOR:	KYNNARPS	LAPERCHE	LIPS	LITTO
KYNNARPS (GB)				
LAPERCHE (F)				
LIPS (NL)				
LITTO (B)				
LOB (PL)				
LOCKWOOD (AUS)				
L. & F. (GB)				
	 KNA-1D	BDC  LAP-88 FICHET	35  LIP-1GD	 LIT-7D







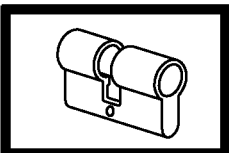

PARA-FOR:	LOB		LOCKWOOD	
				
	 PP LB-2D	 PP LB-2D.P	 B 0 AL 9 A LWO-2  LWO-2D	24A  LWO-7D
	 B LB-4D			
	BRICARD-EXPRES-REDY-YETI			

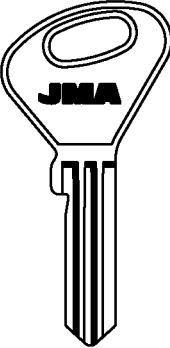
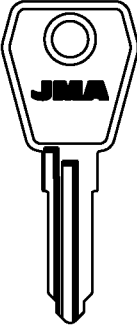
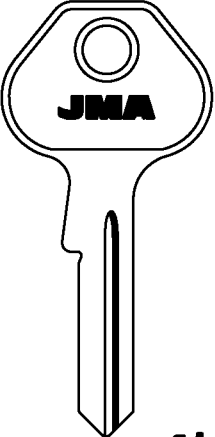
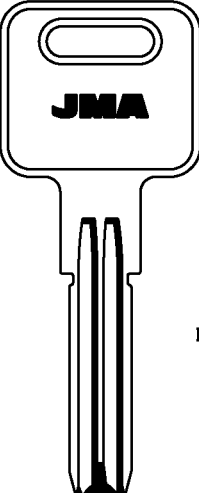
PARA-FOR:	LOCKWOOD		LOWE & FLETCHER	
				
	CL. 1-1000  LWO-8	N  LWO-9 LEN-LOK	19...1-42017001-190007001-8000  LF-20  B  LF-20D	V..1-88  LF-25 14001-14088  LF-40  B

Copyright by
Alejandro Altuna S.A.
2009

JMA











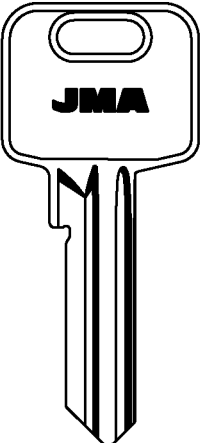





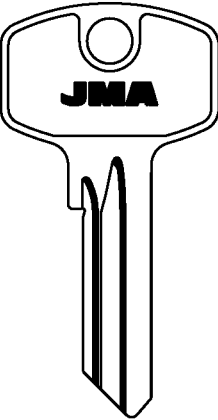

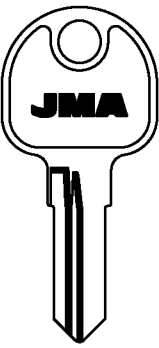
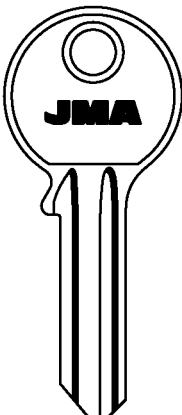
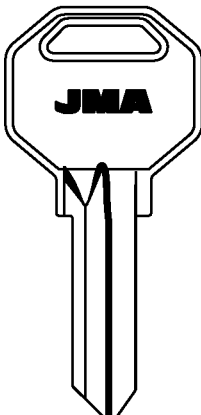
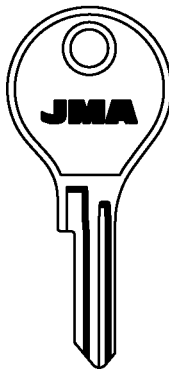

PARA: FOR:	LOWE & FLETCHER	MASTER	MASTER LOCK
			
 LF-36	 LF-37D  LF-38D	 MAS-2D  MAS-22D  7000  B	 MASL-1

PARA-FOR:

- L. & F. (GB)
- MASTER (USA)
- MASTER LOCK (TJ)
- MCM (E)
- MERONI (I)
- METAL (BG)
- MILA (DK)
- MLM (F)

LAT.

PARA: FOR:	MCM	MERONI
	 MCM-24B  MCM-24C  MCM-24D  MCM-24E  MCM-24F  MCM-26	
	 MCM-29D	
		 MER-19D



PARA: FOR:	MERONI	METAL	MILA	MLM
				
 MER-20D  MER-21D	 MTL-1  MTL-1D	 MI-5D TRINITY	 MLM-6  MLM-7	

Copyright by
Alejandro Altuna S.A.
2009

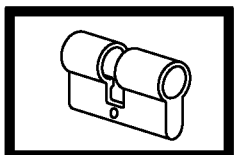
JMA

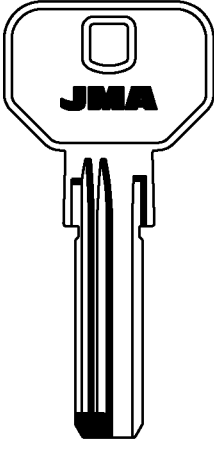
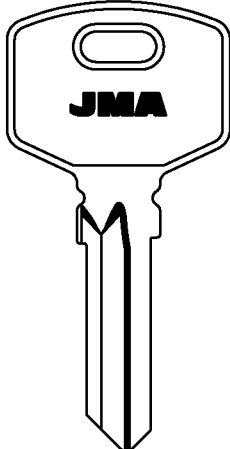
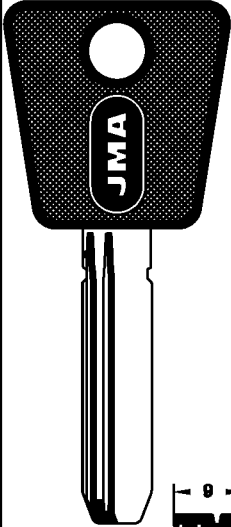
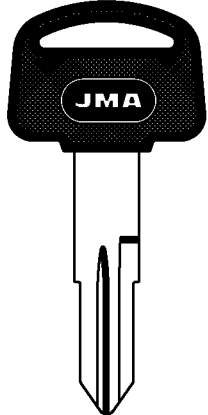
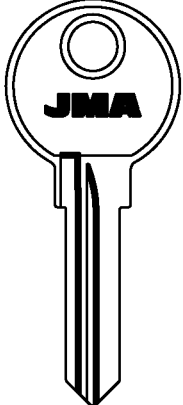
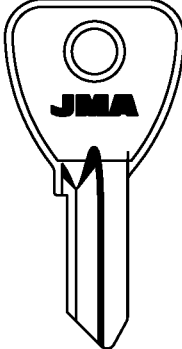
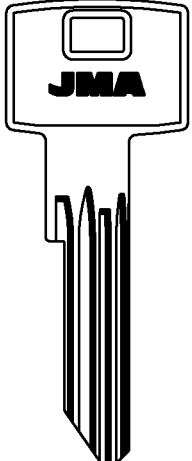
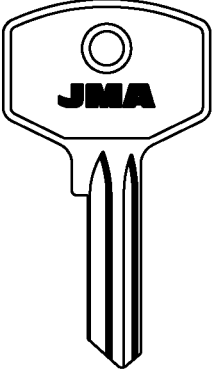
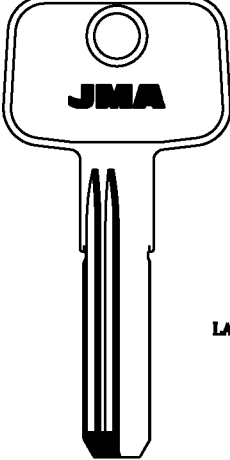
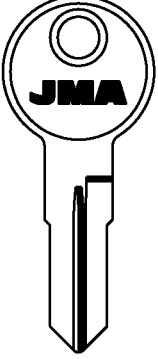
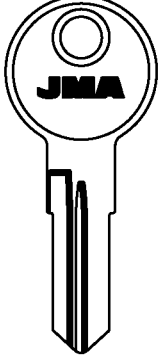
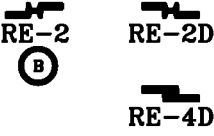

PARA-FOR:

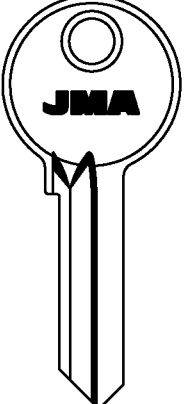
PARA-FOR:	MSM	MUL.T.LOCK	OJMAR
MSM			
MUL.T.LOCK (IL)			
OJMAR (E)			
OMECA (I)			
PAFFENHAIN (D)			
PHOENIX (GB)			
POTENT (I)			
RENZ (D)			
RITA			
PARA-FOR:	OJMAR	OMECA	PAFFENHAIN
			
			
PARA-FOR:	POTENT	RENZ	
			
			
			





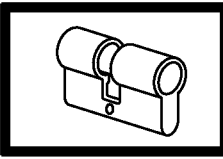





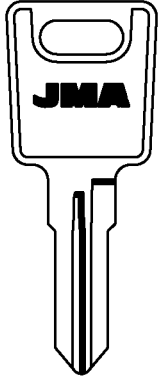
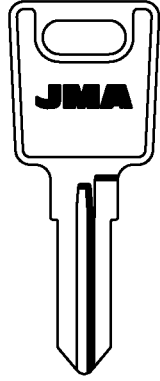





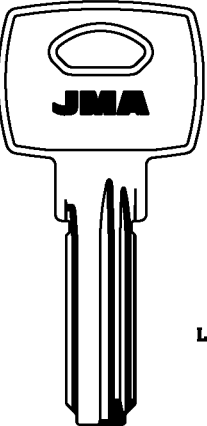
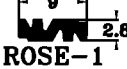
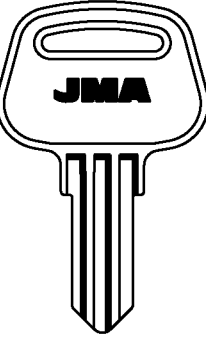

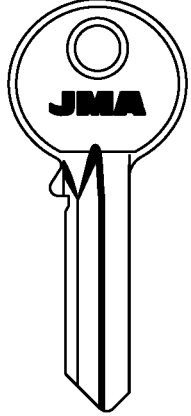

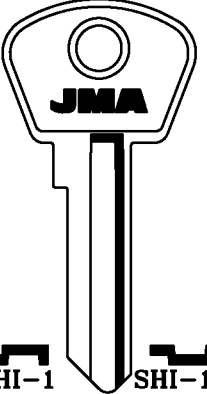

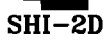
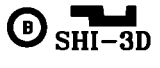
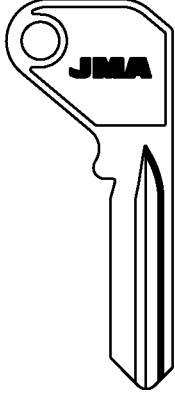

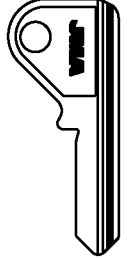
Copyright by
Alejandro Altuna S.A.
2009

JMA

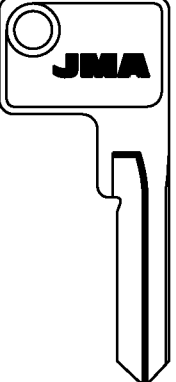
16

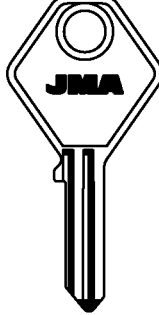
ATENCION:Concarnente a las marcas y denominaciones comerciales ver nota en indice.ATTENTION:Concerning the marks and commercial denominations see note in index. ATTENTION:Concernant les marques et denominations commerciales voir la note dans l'index.ACHTUNG:Beziehen auf die marke und handelsname sehen sie die notiz im index.

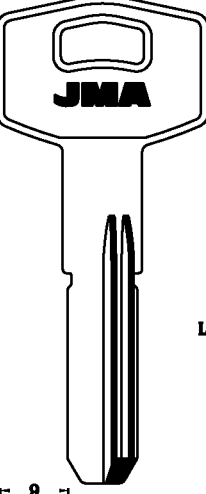
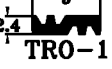
PARA: FOR:	RONIS	ROSSETTI	ROYAL
      	 	 	
PARA: FOR:	SCHUCO	SHILUTE	SQUIRE & SONS
 	   	 	 
PARA: FOR:	SQUIRE & SONS	STREBOR	TARONI
 	 	 	  

PARA-FOR:

- RONIS (F)**
- ROSSETTI (I)**
- ROYAL (RC)**
- SCHUCO (D)**
- SHILUTE (RUS)**
- SQUIRE & S. (GB)**
- STREBOR (GB)**
- TARONI (I)**

Copyright by
Alejandro Altuna S.A.
2009

JMA

LAT.

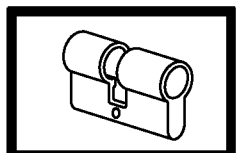

17

PARA-FOR:

TEICOCIL (P)

TESA (E)

TIFON (RC)

TIGRIS (GB)

TITAN (YU)

PARA: FOR: TEICOCIL

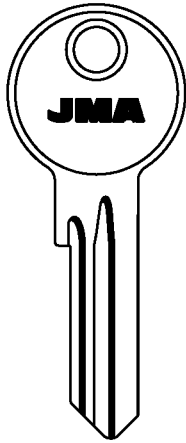

TEI-1D

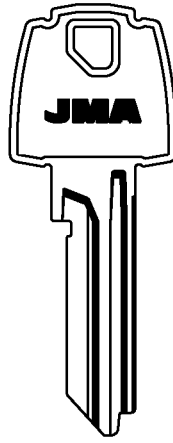

TE-28

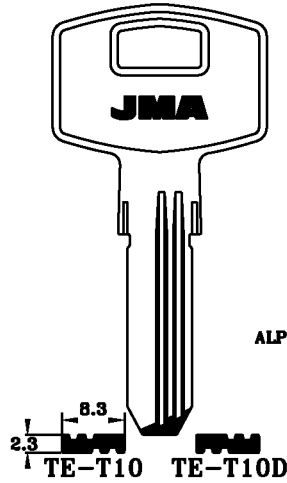

TE-T10 TE-T10D



TE-T11

CORNI-ELCA-ESAFE-FAC-ST5

TESA

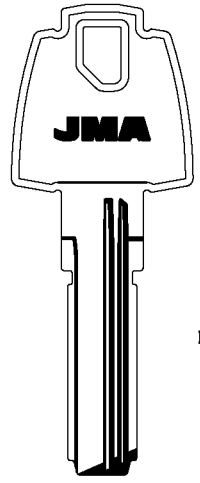

TE-T62

ALP.

LAT.

PARA: FOR:

TIFON

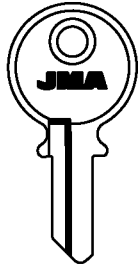

TIF-2D



TIF-15/20



TIF-25D

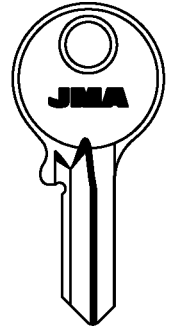

TIF-30D



PARA: FOR:

TIFON

TIGRIS

TITAN

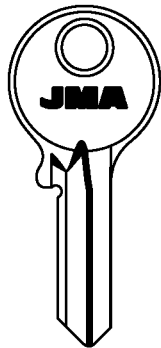

TIF-40D

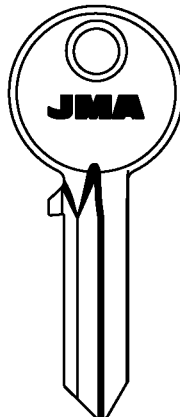

TIF-50/60

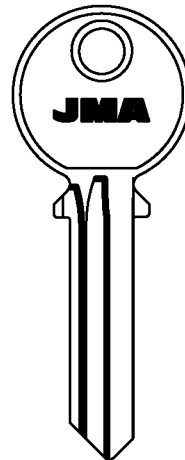

TIG-1D

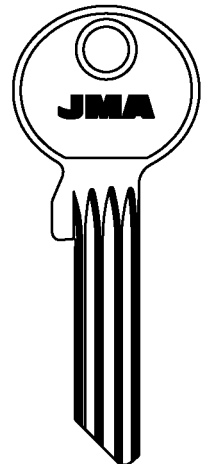







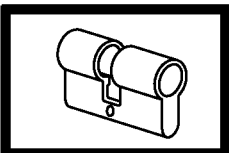

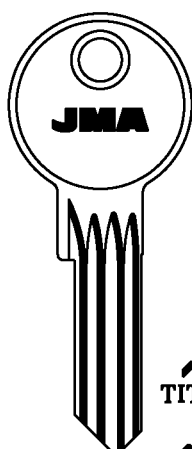





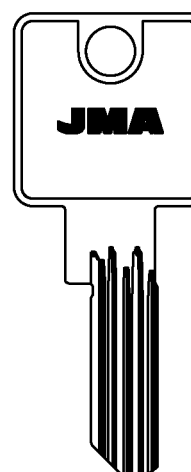







TIT-14 TIT-14D









Copyright by
Alejandro Altuna S.A.
2009

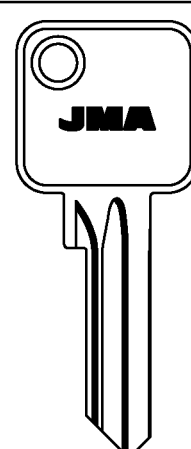
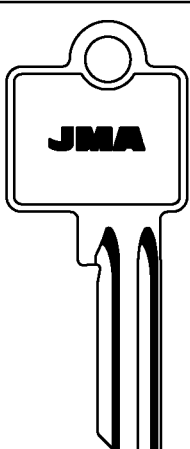
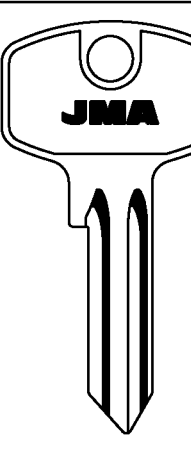
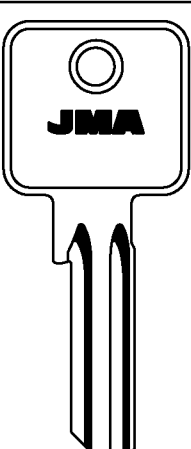







JMA

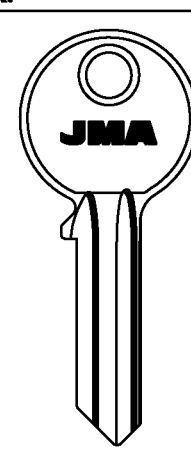
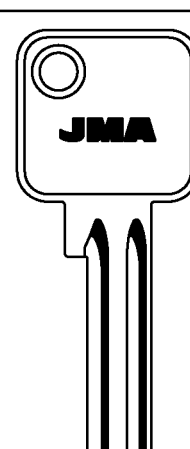
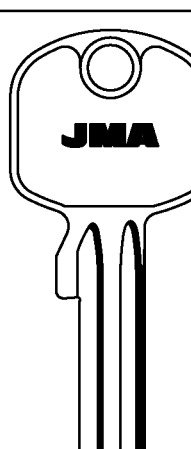
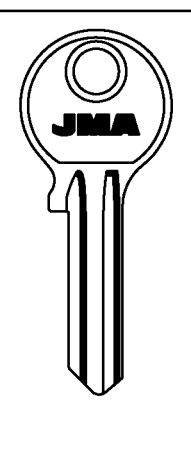

PARA: FOR:	TITAN	TOK WINKHAUS	
 TIT-18D  TIT-16D  TIT-15  TIT-15D  TIT-17 		 BFA3  BIF-1 ENAX  TOK-7D BFA1  TOK-32 EAPF  TOK-23 BFA2  TOK-15 BFA2  TOK-13D EFAM  EFWS  TOK-11 EHBA  EKCP  TOK-9 BFA1  TOK-34D BFA1  TOK-28D BYNY1  TOK-16D BYNY1  TOK-14D EWSB  TOK-12 FAABF  TOK-10D	
	PICARDIE	FICHET-BIFFAR	

PARA-FOR:
TITAN (YU)
TOK WINKHAUS (D)
UNIVERSAL

PARA: FOR:	UNIVERSAL			
				
	 U-5BD	 U-5KI	 U-5KD	 U-5QI
		 U-5QD	 U-5SI	 U-5SD

PARA: FOR:	UNIVERSAL			
				
	 U-5SP	 U-5DSP	 U-6BD	 U-15GI
			 •U-15GD	 U-17
				 U-17D

Copyright by
Alejandro Altuna S.A.
2009
JMA

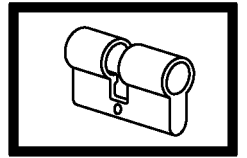

ATENCION:Concerniente a las marcas y denominaciones comerciales ver nota en indice.ATTENTION:Concerning the marks and commercial denominations see note in index.
ATTENTION:Concernant les marques et denominations commerciales voir la note dans l'index.ACHTUNG:Beziehen auf die marke und handelsname sehen sie die notiz im index.

PARA-FOR:

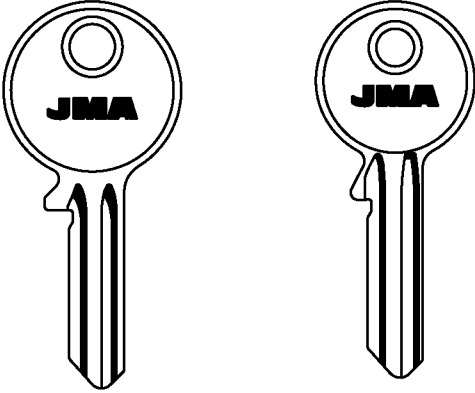
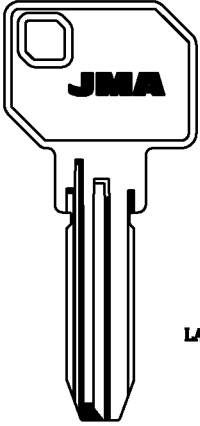
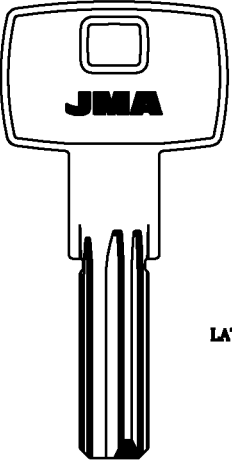
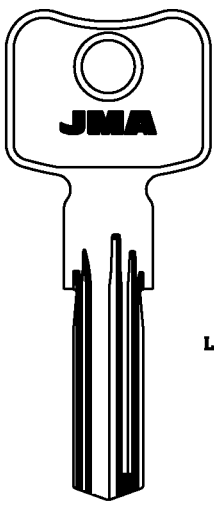
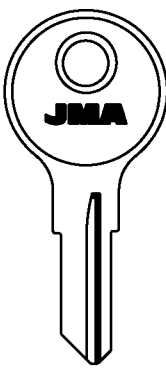
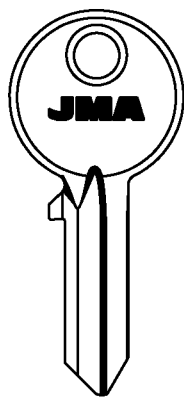
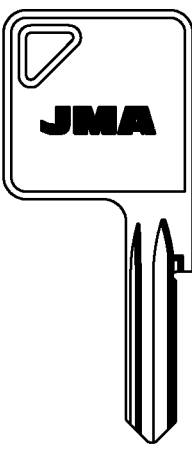
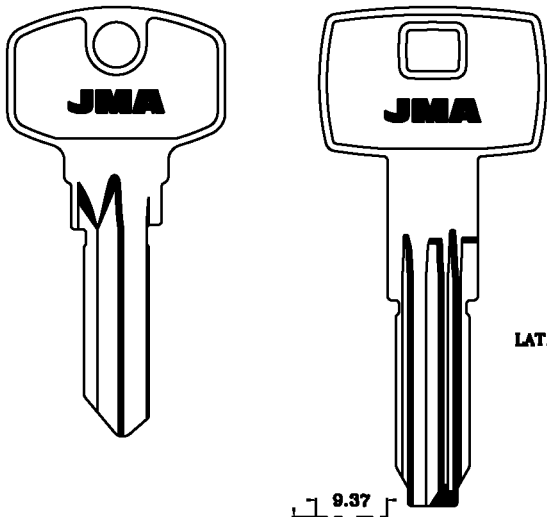

<p>PARA-FOR: UNIVERSAL</p>  <p>U-22 U-22D U-25 U-25D</p>	<p>URBIS</p>  <p>LAT.</p> <p>8.7 2.45 URB-3D</p> <p>BANE SEKULIC</p>	<p>VIRO</p>  <p>LAT.</p> <p>8.75 2.9 VI-14 EURO-PRO</p>	
<p>PARA-FOR: WILKA</p>  <p>LAT.</p> <p>WIL-22 SERIE 3000</p>	<p>WIREROPE</p>  <p>WIR-1</p>	<p>WMS</p>  <p>WM-5D</p> <p>I.R.-TITUS</p>	<p>YALE</p>  <p>LAT.</p> <p>YA-72 DRAPER</p>
<p>PARA-FOR: YALE</p>  <p>LAT.</p> <p>9.37 2.65 YA-79D YA-81</p>			

Copyright by
Alejandro Altuna S.A.
2009

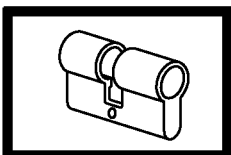
JMA



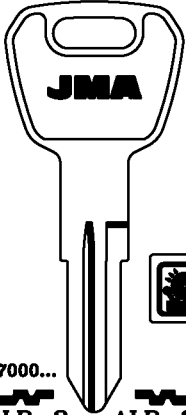
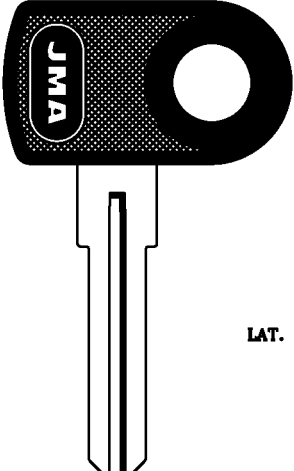
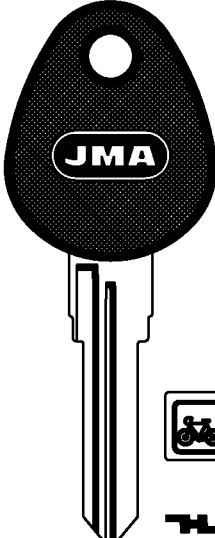



20

PARA: FOR: ALPHA	AXA	DACIA
 <p>7000... ALP-2 ALP-2D JD-LINCE-MONACOR SANY-VISONIC S...301-600 ALP-6 ALP-6D FEB</p>	 <p>LAT. AX-2.P</p>  <p>AX-3D.P</p>	 <p>DAC-3DC1</p>

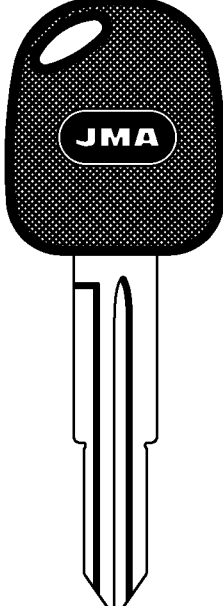
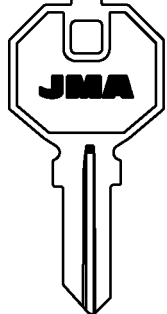
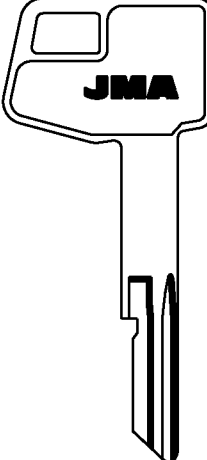
PARA-FOR:

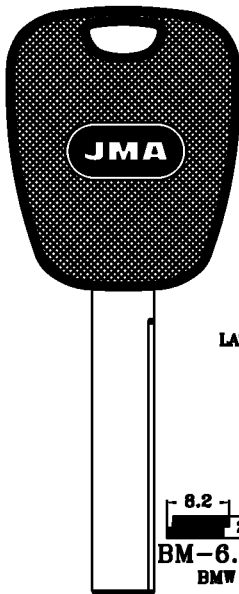
- ALPHA (J)
- AXA (S)
- DACIA (R)
- DAEWOO (K)
- DOBLE G (ARG)
- G.M. (USA)
- HUF (D)

PARA: FOR: DAEWOO	DOBLE G	G.M.
 <p>DAE-3.P2 DAE-3D.P2</p>	 <p>GG-1D</p>	 <p>0000-1999 GM-42</p>

PARA: FOR: HUF			
 <p>LAT. BM-6.P BMW</p>	 <p>ALP. FO-24C1</p>	 <p>ALP. FO-24C2</p>	 <p>ALP. HU-HAAC1</p>

Copyright by
Alejandro Altuna S.A.
2009

JMA

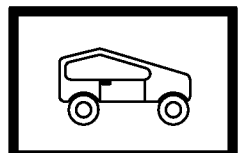

PARA-FOR:

- HUF (D)**
- HYUNDAI (K)**
- ISUZU (J)**
- KYMCO (K)**

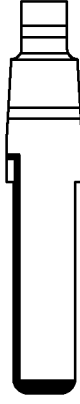
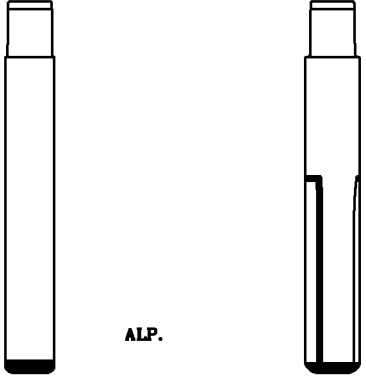
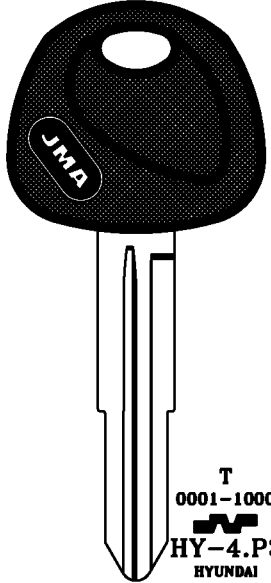
PARA: FOR:	HUF	HYUNDAI	
	 <p>ALP.</p> <p>HU-HAAC2</p> <p>HU-NAAC2</p>	 <p>ALP.</p> <p>ALP.</p> <p>Z...1-2000 Z...2001-4000 Z...4001-6000</p> <p>OP-11C1</p> <p>H... WH... 0001-3000</p> <p>OP-WHC1</p>	 <p>T 0001-1000</p> <p>HY-4.P3 HYUNDAI</p>

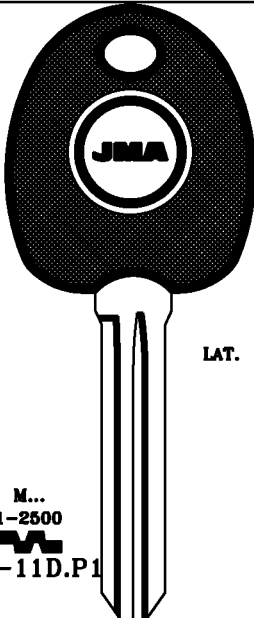
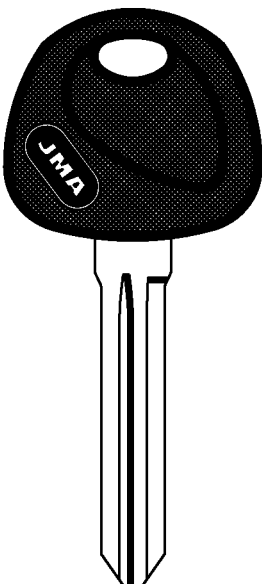
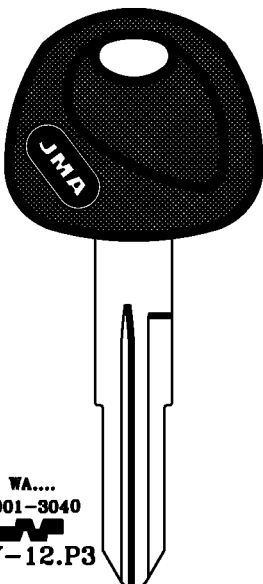

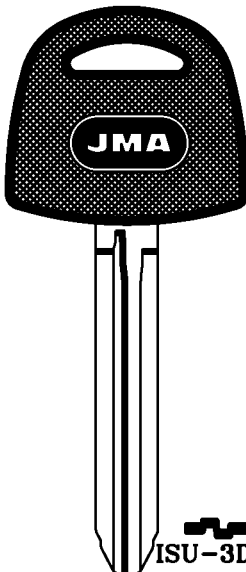
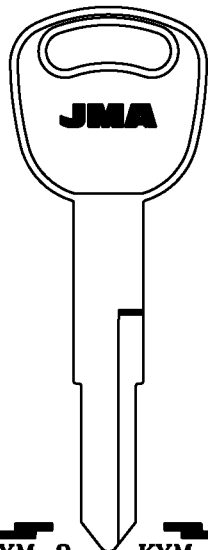
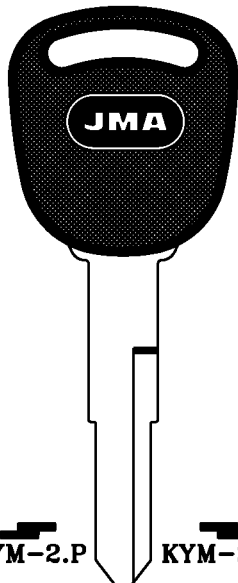





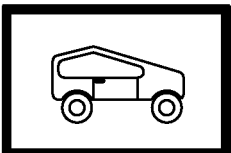

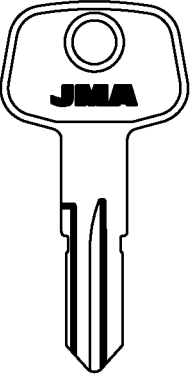

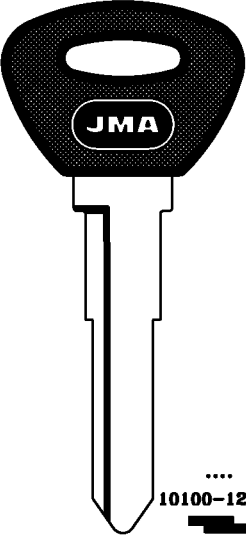

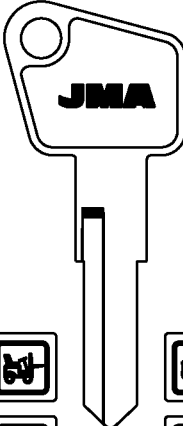
PARA: FOR:	HYUNDAI
	 <p>LAT.</p> <p>M... 1-2500</p> <p>HY-11D.P1</p>   <p>M... 1-2500</p> <p>WA... 1001-3040</p> <p>HY-11.P3 HY-11D.P3 HY-12.P3</p>

PARA: FOR:	ISUZU	KYMCO
	 <p>ISU-3D.P</p>	 <p>KYM-2</p>  <p>KYM-2D</p> <p>KYM-2.P</p> <p>KYM-2D.P</p>

Copyright by
Alejandro Altuna S.A.
2009

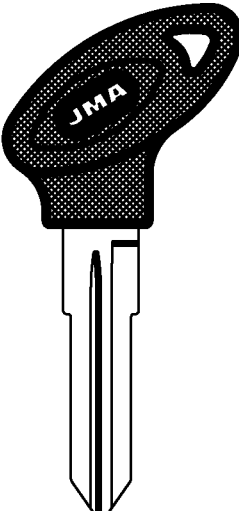
JMA

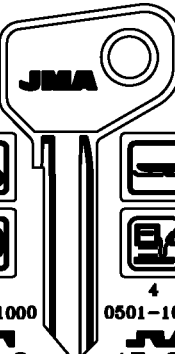
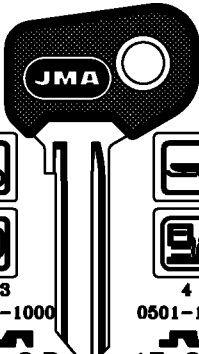
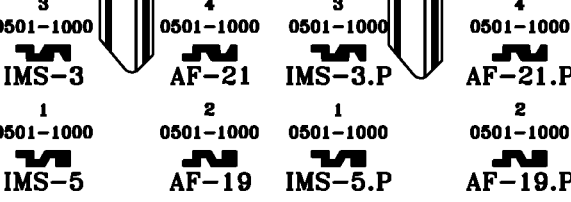
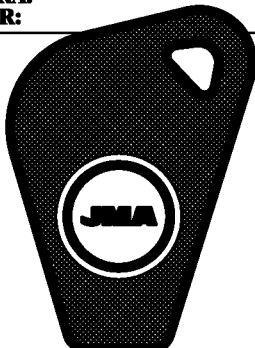
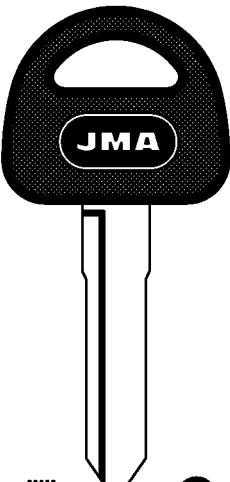
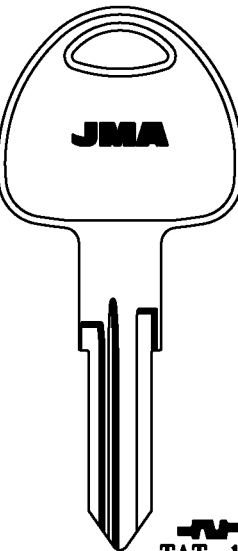

PARA: L. & F. FOR:	MAZDA	MERIT-LINDE	NISSAN
  LF-39D	  10100-12099 MAZ-21D.P1	  MERI-1D	  X....1-9000 DAT-6C1 VALEO
PARA: NISSAN FOR:	PGO	SAFE	
  DAT-15C1 VALEO	  PGO-2.P	   3 0501-1000 IMS-3 4 0501-1000 AF-21 1 0501-1000 IMS-5 2 0501-1000 AF-19 IMS-13 ^(B) BLOSTER CROMODORA-FIST-IMSA	
PARA: FOR:	SUZUKI		TATA
 SUBARU ALP. T....1-3000 SUB-2.P	 16501-17704 ^(B) SUZU-7.P SUZU-7D.P SUZU-14.P2 GM-MARUTI-SUZUKI		  TAT-1D

PARA-FOR:
L. & F. (GB)
MAZDA (J)
MERIT-LINDE (D)
NISSAN (J)
PGO (J)
SAFE (I)
SUBARU (J)
SUZUKI (J)
TATA (IND)

Copyright by
Alejandro Altuna S.A.
2009

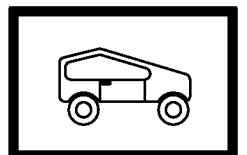
JMA

23

PARA-FOR:

TATA (IND)

TOYOTA (J)

TRW-SIPEA (I)

VALEO (F)

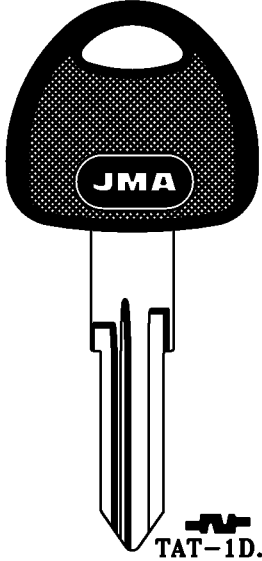
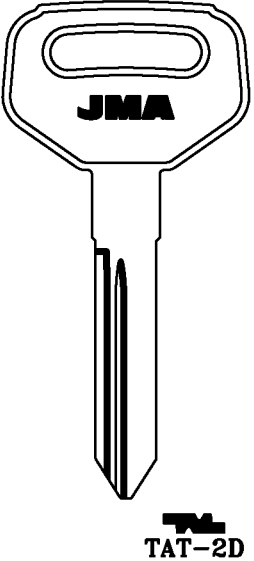
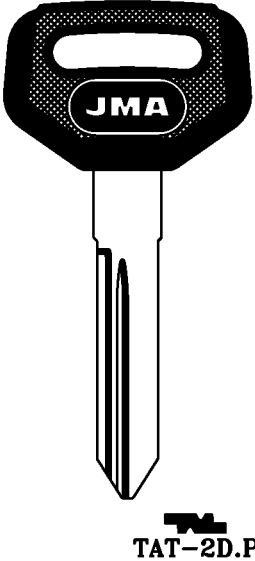
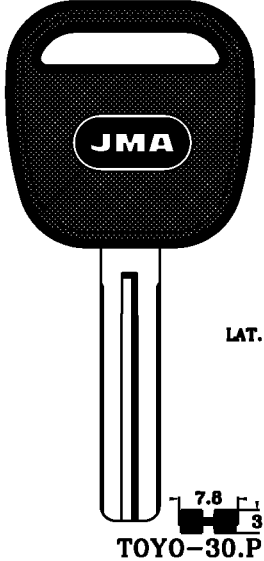
PARA: FOR:	TATA		TOYOTA
	 TAT-1D.P	 TAT-2D	 TAT-2D.P
			 TOYO-30.P1

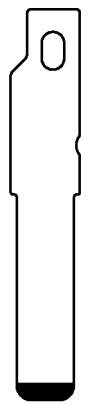
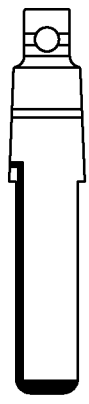
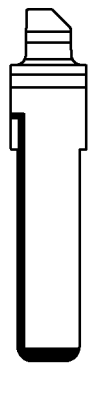
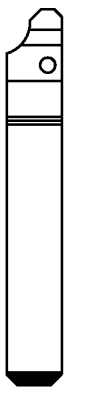
PARA: FOR:	TRW-SIPEA	VALEO		
	 FI-16C1	 HU-HAAC3	 HU-HAAC4	 PEU-1C1

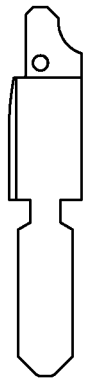
PARA: FOR:	VALEO			
	 PEU-2C1			

Copyright by
Alejandro Altuna S.A.
2009

JMA

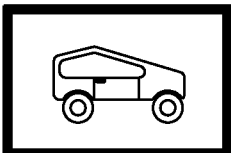

24

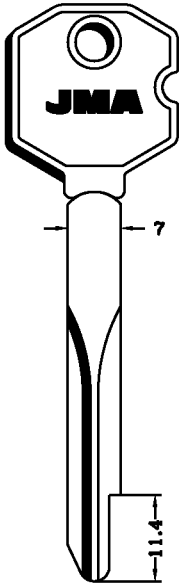
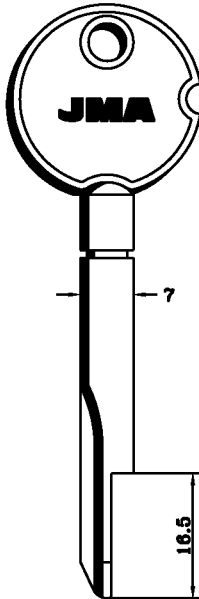
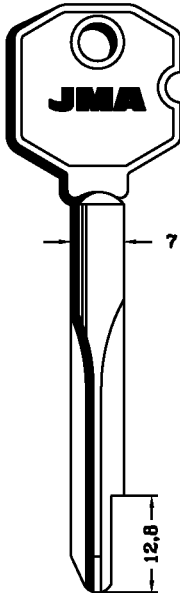
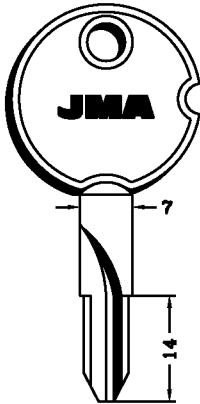
PARA: FOR:	FAYN	GERA	ISEO	LOCK-IT
	 <p>FAY-1X</p>	 <p>GEA-3X</p>	 <p>ISEO-1X</p>	 <p>LCK-1X</p>

PARA-FOR:

FAYN (TR)

GERA (D)

ISEO (I)

LOCK-IT (GB)

MSV (P)

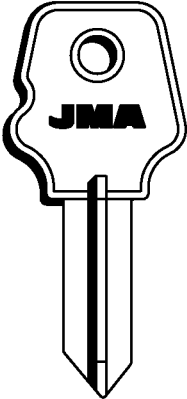
PARA: FOR:	MSV
 <p>MSV-1X</p>	

Copyright by
Alejandro Altuna S.A.
2009

JMA

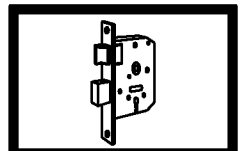

25

PARA-FOR:

AKARSAN (TR)

BETA (I)

BOGATIR (RUS)

CISA (I)

CR (I)

AKARSAN	BETA	BOGATIR
<p>4.8 76 mm. 11.2 22.2 AKA-1PG</p>	<p>4.50 66.1 mm. 13.20 21.60 BE-10G</p>	<p>4.90 99.5 mm. 18.40 26 BOG-2G</p>

CISA	CR
------	----

<p>4.9 110 mm. 24.3 21.1 CI-13G CI-14G</p>	<p>4.6 114 mm. 24.50 21.90 CR-17TG</p>
--	--

Copyright by
Alejandro Altuna S.A.
2009

JMA

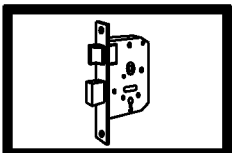

26

PARA:
FOR:

CR

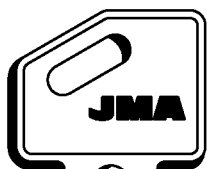

4.8

116 mm

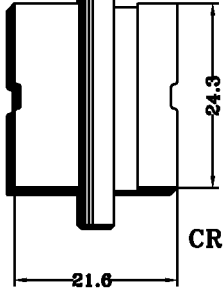

CR-18G

21.6



24.3

DAR-MAR



5.9

77.9 mm.

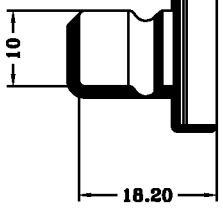

18.20



DMR-6-1



DMR-6-2



DMR-6-3



DMR-6-4

PARA:
FOR:

DAR-MAR

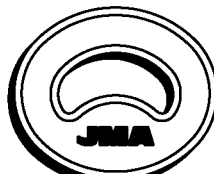

5.9

77.9 mm.

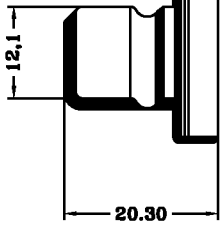

20.30

12.1

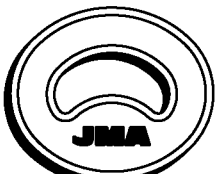

6.9

62.5 mm.

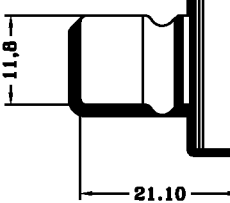

21.10

11.8



DMR-6-1L



DMR-6-2L



DMR-6-3L



DMR-6-4L



DMR-7-1



DMR-7-2



DMR-7-3



DMR-7-4

PARA-FOR:

CR (I)

DAR-MAR (PL)

Copyright by
Alejandro Altuna S.A.
2009

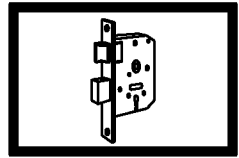

ATENCION:Concerniente a las marcas y denominaciones comerciales ver nota en indice.ATTENTION:Concerning the marks and commercial denominations see note in index.
ATTENTION:Concernant les marques et denominations commerciales voir la note dans l'index.ACHTUNG:Beziehen auf die marke und handelsname sehen sie die notiz im index.

PARA-FOR:

DEKABA

ERA

ESETY

FIAM

DEKABA (BG)

ERA (GB)

ESETY (I)

FIAM (I)

GARDIAN (RUS)

GIMAST (I)

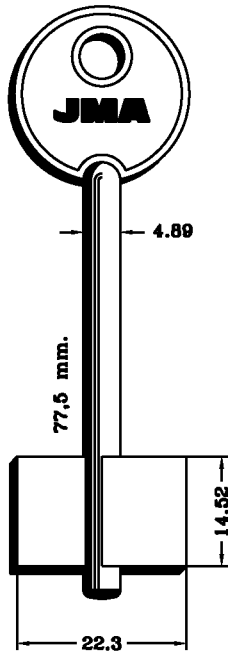

DEK-1G

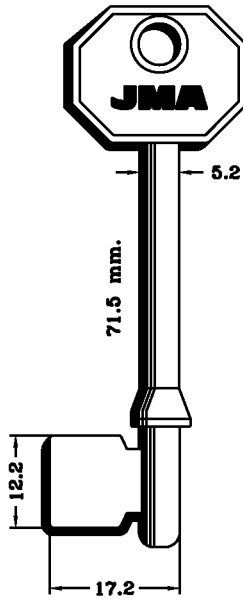

ER-5G

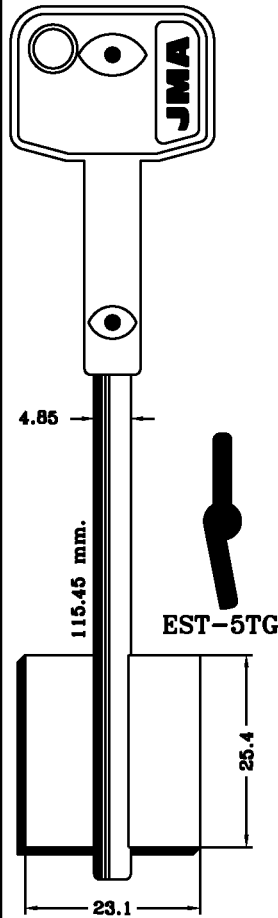

EST-5TG

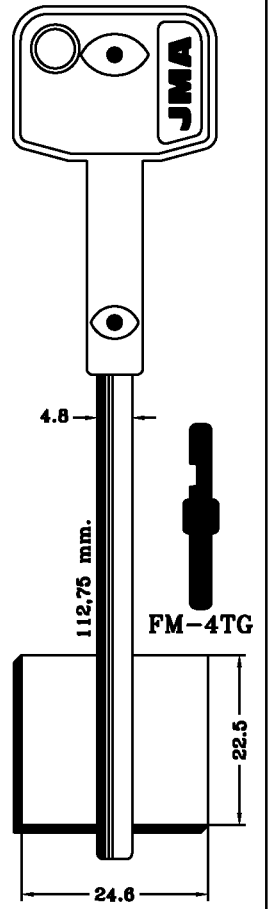

FM-4TG

PARA-FOR: FIAM

GARDIAN

GIMAST

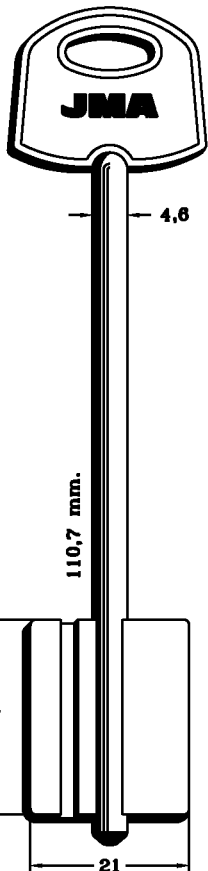

FM-20G

ISEO

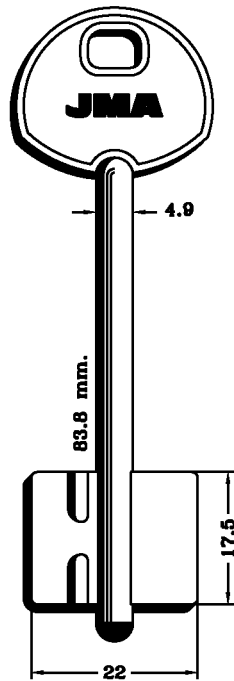

GARD-1G

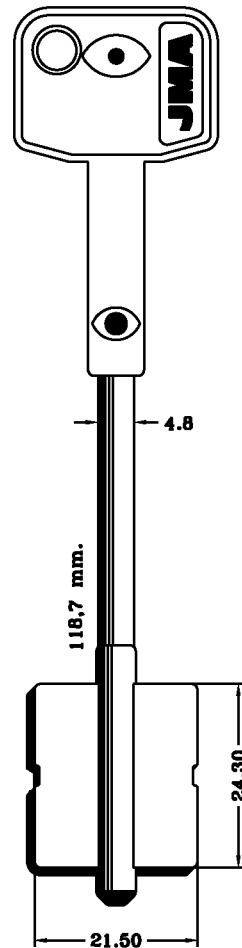

GIM-1TG

Copyright by
Alejandro Altuna S.A.
2009

JMA

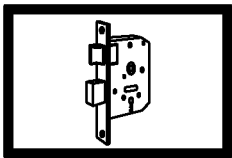

28

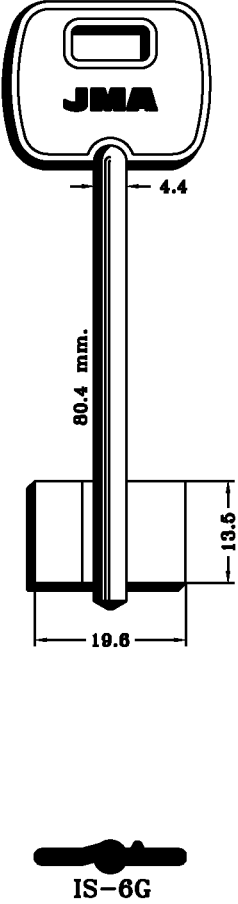
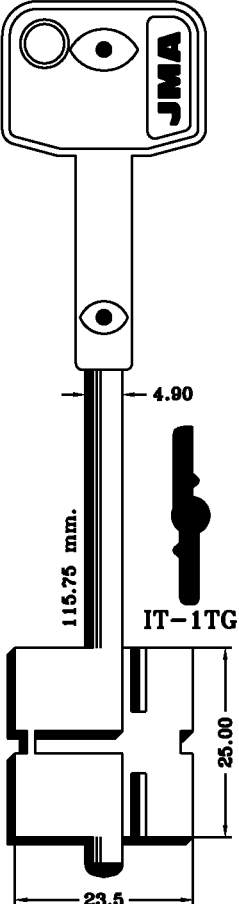
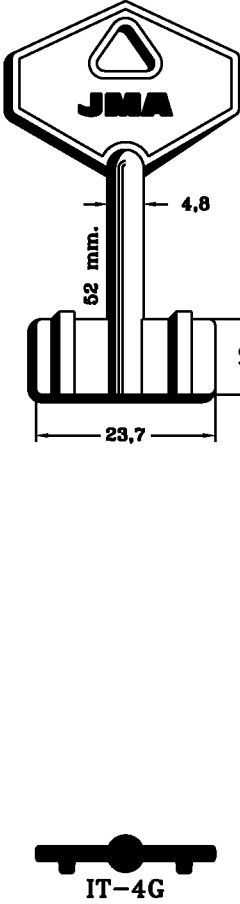
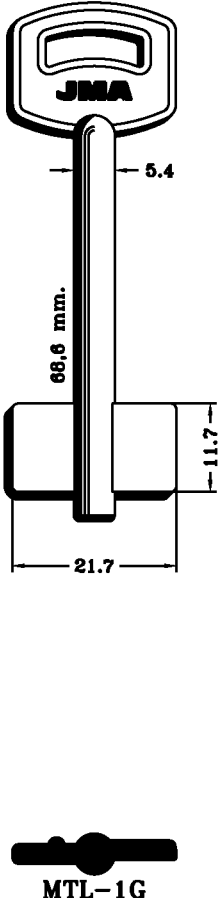
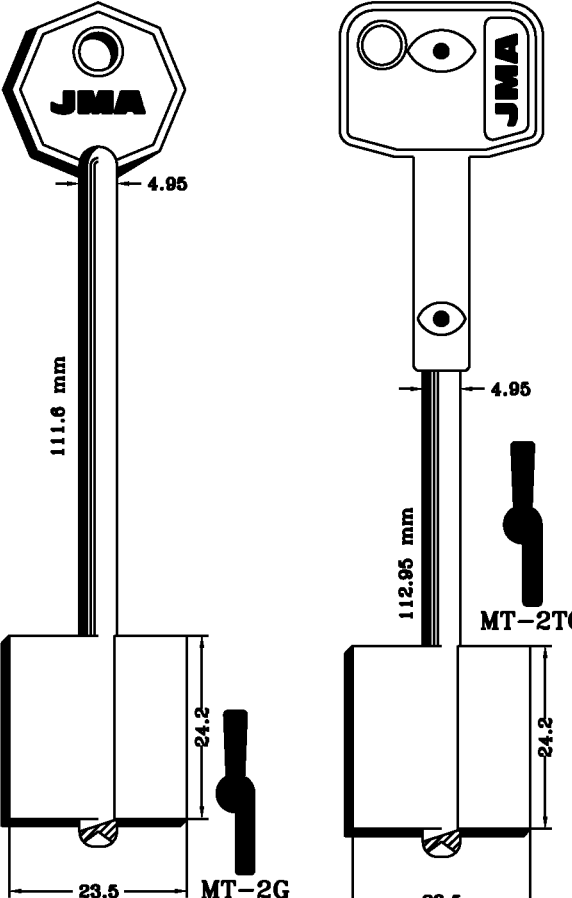
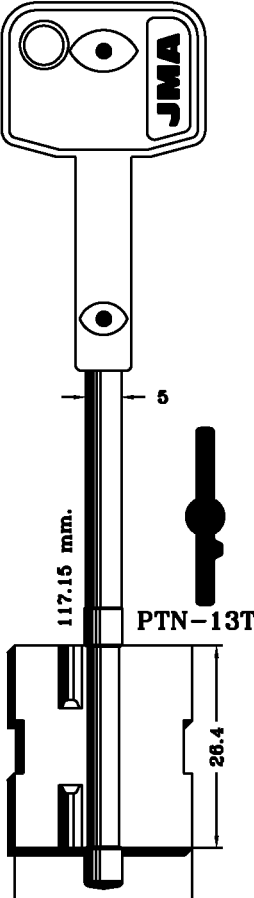
PARA: ISEO FOR:	ITAL	KALE
		
PARA: METAL FOR:	MOTTURA	POTENT
		

PARA-FOR:
ISEO (I)
ITAL (I)
KALE (TR)
METAL (BG)
MOTTURA (I)
POTENT (I)

Copyright by
Alejandro Altuna S.A.
2009

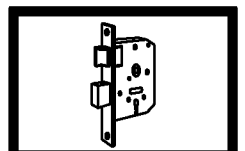
JMA

29

PARA-FOR:

PARA:
FOR:

RUBEN

SAM

RUBEN (RUS)

SAM (RUS)

SIAS (I)

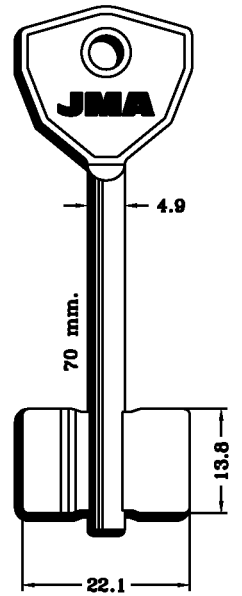
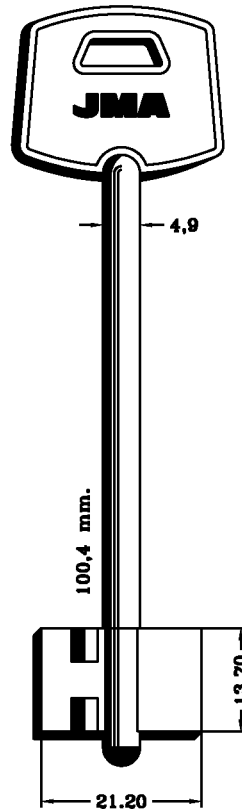
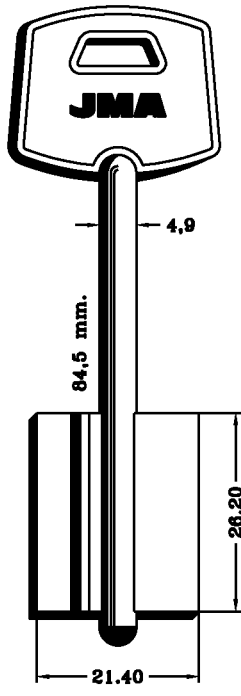
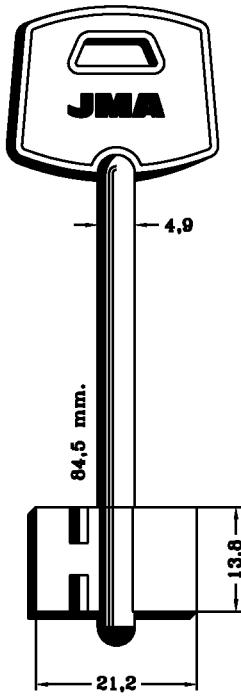

PARA:
FOR:

SIAS

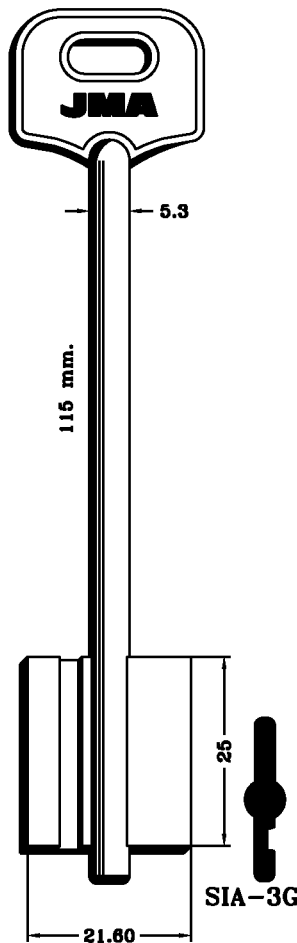
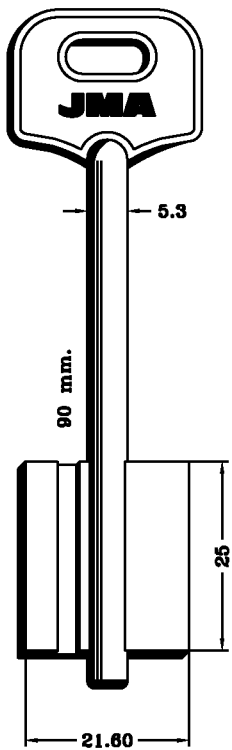

Copyright by
Alejandro Altuna S.A.
2009

JMA

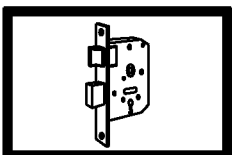

30

MARCA	MODELO						
FORD (AUSTRALIA)	EXPLORER TAURUS TAURUS WAGON	96-97 96-97 96-97	FO-15D FO-15DP	FO-15D FO-15DP	FO-15D FO-15DP	FO-15D FO-15DP	FO-15D FO-15DP
GM (CHEVROLET)	SPARK	-	DAE-3P2	DAE-3P2	DAE-3P2	DAE-3P2	DAE-3P2
GM (OLDS MOBILE)	ALERO INTRIGUE	00-04 00-03	GM-14 GM-14P	GM-14 GM-14P	GM-14 GM-14P		
GM (PONTIAC)	GRAND AM	00-05	GM-14 GM-14P	GM-14 GM-14P	GM-14 GM-14P		
	SUNFIRE	00-05	GM-25 GM-25P	GM-25 GM-25P	GM-25 GM-25P		
HOLDEN	BELMOND CALAIS COMMODORE KINGSWOOD STATESMAN	-1979 1978- 1978- 1979- 1978-	GM-42	GM-42	GM-42		
HUMMER	H2	2005-				RE-1D	
	H3	2005-				BL-2	
HYUNDAI	ELANTRA LANTRA	91-96 91-96	HY-4P3	HY-4P3	HY-4P3	HY-4P3	
	TIBURON	2001	HY-4 HY-4P HY-4P2 HY-4P3	HY-4 HY-4P HY-4P2 HY-4P3	HY-4 HY-4P HY-4P2 HY-4P3	HY-4 HY-4P HY-4P2 HY-4P3	HY-4 HY-4P HY-4P2 HY-4P3
ISUZU	D-MAX	02-06	ISU-3DP	ISU-3DP	ISU-3DP	ISU-3DP	
	VEHY-CROSS	98-02	SUZU-10P	SUZU-10P	SUZU-10P	SUZU-10P	SUZU-10P
KIA	CLARENCE CLARUS PRIDE RIO SORENTO	2001- 98-01 1999- 2001- 1998-	KI-3DP	KI-3DP	KI-3DP	KI-3DP	KI-3DP
MAZDA	ARTIS	-	MAZ-21DP1	MAZ-21DP1	MAZ-21DP1	MAZ-21DP1	MAZ-21DP1
MITSUBISHI	L 400	1997-	MIT-7P	MIT-7P	MIT-7P	MIT-7P	MIT-7P
PEUGEOT	PARTNER	1997	SIX-3P1 SIX-3P2	SIX-3P1 SIX-3P2	SIX-3P1 SIX-3P2		SIX-3P1 SIX-3P2
SSANGYONG	KORANDO	2000-	HY-5 HY-5P	HY-5 HY-5P	HY-5 HY-5P	HY-5 HY-5P	HY-5 HY-5P
TATA	INDICA	2000-	TAT-1D TAT-1DP	TAT-1D TAT-1DP	TAT-1D TAT-1DP	TAT-1D TAT-1DP	TAT-1D TAT-1DP

MARCA	MODELO						
ISUZU	NKR NPR NQR	- - -	MIT-15P	MIT-15P			

MARCA	MODELO						
DERBY	MULHACEN	2006-	ZA-9P1	ZA-9P1		ZA-9P1	
GILERA	NCR 50 NEXUS RUNNER	2006- 2006- 2006-	ZA-9P1	ZA-9P1		ZA-9P1	
HONDA	CBF 500 CBF 600 FORZA	2004- 2004- 2005-	HOND-24P	HOND-24P	HOND-24P	HOND-24P	HOND-24P
	DYLAN 125 PS 125I PS 150I SH 125I SH 150I	2004- 2006- 2006- 2005- 2006-	ZA-9P1	ZA-9P1	ZA-9P1	ZA-9P1	ZA-9P1
KAWASAKI	KLX 1000	2004-	SUZU-12DP	SUZU-12DP			
	Z 750	2004-	KAW-9P	KAW-9P	KAW-9P	KAW-9P	
PGO	COMET PMS PMX RODOSHOW TREX	2000- 2000- 2000- 2000- 2000-	PGO-2P				
SUZUKI	GS 500 F GSF BANDIT GSX R1300 GZ 250 LR GSX 600 SV 650 SV 750 VL 800 VZ 1600 V-STROM 650 V-STROM 1000	2004- 2004- 2004- 2004- 2004- 2004- 2004- 2004- 2004- 2004- 2004- 2004-	SUZU-12DP	SUZU-12DP			
	KATANA R	2004-	ZA-9P1	ZA-9P1			
TRIUMPH	AMERICA BONNEVILLE DAYTONA ROCKET III SCRAMBLER SPEEDMASTER SPRINT ST THRUXTON TIGER	2006- 2006- 2006- 2006- 2006- 2006- 2006- 2006- 2006-	ZA-9P1			ZA-9P1	
YAMAHA	MAJESTY 250	2005-	ZA-9P1	ZA-9P1	ZA-9P1	ZA-9P1	

SIMBOLOGÍA

	<p>Accesorio a pedido especial <i>Accessory on specific request</i> <i>Accessoire sur demande spécifique</i> <i>Zubehör auf spezifischen Wunsch</i> <i>Accessorio su richiesta specifica</i></p>		<p>Fresa a cortes laterales <i>Miling cutter with side cuts</i> <i>Fraise à découpes latérales</i> <i>Fräser mit Seiteneinschnitten</i> <i>Fresa a tagli laterali</i></p>
	<p>Máquina duplicadora fuera de producción <i>Discontinued machine</i> <i>Machine à reproduire les clés hors production</i> <i>Schlüsselkopiermaschine ausser Produktion</i> <i>Duplicatrice fuori produzione</i></p>	<p>W</p>	<p>Fresa en acero duro <i>Carbide cutter</i> <i>Fraise au carbure</i> <i>Hartmetall Fräser</i> <i>Fresa in metallo duro</i></p>
	<p>Diámetro externo <i>External diameter</i> <i>Diamètre extérieur</i> <i>Aussen-Durchmesser</i> <i>Diamtro esterno</i></p>	<p>FP ...</p>	<p>Fresa opcional <i>Optional cutter</i> <i>Fraise optional</i> <i>Fakultative fräser</i></p>
	<p>Diámetro interior <i>Internal diameter</i> <i>Alésage</i> <i>Innen-Durchmesser</i> <i>Diamtro foro</i></p>		<p>Fresa standard <i>Standard cutter</i> <i>Fraise standard</i> <i>Standard fräser</i></p>
	<p>Espesor <i>Cutter thickness</i> <i>Épaisseur</i> <i>Stärke</i> <i>Spessore</i></p>		<p>Distancia corte <i>Thread size</i> <i>Dimension taraudage</i> <i>Gewindeschneiden</i> <i>Filettatura</i></p>
	<p>Ángulo de corte <i>Cutting angle</i> <i>Angle de coupe</i> <i>Einschnittwinkel</i> <i>Angolo di taglio</i></p>		<p>Largo <i>Length</i> <i>Longueur</i> <i>Länge</i> <i>Lunghezza</i></p>
	<p>Parte llana ángulo de corte <i>Cutter tip width</i> <i>Partie plate angle de coupe</i> <i>Flach-Einschnitt</i> <i>Piano di cifratura</i></p>	<p>MAT.</p>	<p>Material <i>Material</i> <i>Matériel</i> <i>Material</i> <i>Materiale</i></p>
	<p>Fresa a ángulo puntiagudo <i>Double angle cutter</i> <i>Fraise à foret</i> <i>Spitzen-Einschnitt</i> <i>Fresa a punta</i></p>	<p>HSS</p>	<p>Acero super rápido <i>High Speed Steel</i> <i>Acier super rapide</i> <i>Hochleistung-Schenellstahl</i> <i>Acciaio Super rápido</i></p>
	<p>La llave puede ser reproducida utilizando los utensilios standar suministrados con la máquina. <i>This Key can be cut using the accessories supplied as standard with the machine.</i> <i>Le clé peut être reproduite en utilisant les outils standard fournis avec la machine.</i> <i>Der Schlüssel kann mit dem Zubehör der Maschine werden geschnitten.</i> <i>Chiave eseguibile a copia con accessori in dotazione alla macchina.</i></p>		
	<p>Utilización de los accesorios opcionales para la reproducción de la llave. <i>To duplicate this key, the necessary accessories are available as an optional extra.</i> <i>La clé peut être reproduite en utilisant les outils en option.</i> <i>Der Schlüssel kann mit Optional-Zubehören geschnitten werden.</i> <i>Chiave eseguibile a copia con accessori opzionali.</i></p>		

Fresas

Miling cutters

Fraises

Fräse

Frese

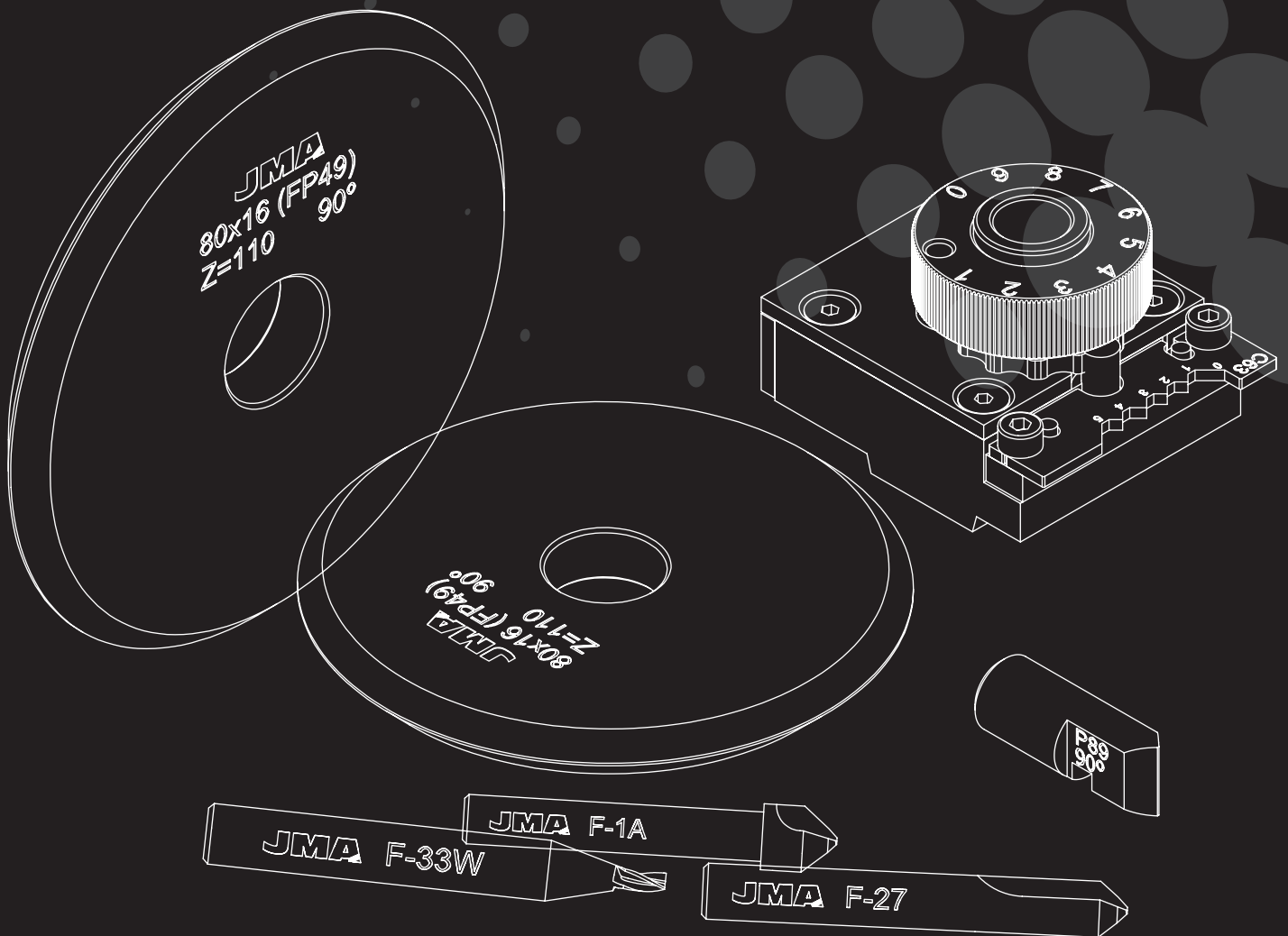

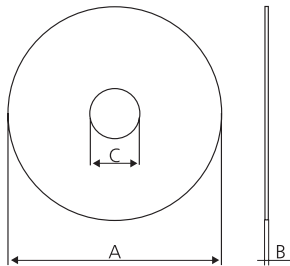

CODE	AxBxC	MAT.	PARA-FOR
FP7	63x1,25x16	HSS	ECCO BIT-DETROIT
FP8*	63x1,4x16	HSS	ECCO BIT-DETROIT
FP9	63x1x16	HSS	ECCO BIT
FP10	63x2,4x16	HSS	ECCO FORD-ECCO ABLOY-PASADENA-NEBRASKA
FP17	80x1,25x16	HSS	SARATOGA-YAKARTA-DAKOTA-TITAN BIT
FP18	80x1,25x22	HSS	ATLANTA-TOPEKA
FP19*	80x1,4x16	HSS	SARATOGA-YAKARTA-DAKOTA G
FP20	80x1,4x22	HSS	ATLANTA-TOPEKA
FP21	80x1,5x22	HSS	DUPLEX-ATLANTA-TOPEKA-KANSAS
FP21W	80x1,5x22	W	DUPLEX-ATLANTA-TOPEKA-KANSAS
FP22	80x1x16	HSS	SARATOGA-DAKOTA G-TITAN BIT
FP23	80x1x22	HSS	DUPLEX-ATLANTA-TOPEKA
FP26	80x1,5x16	HSS	SARATOGA-YAKARTA-DAKOTA-G-SENA
FP26W	80x1,5x16	W	SARATOGA-YAKARTA-DAKOTA-G-SENA

* STANDAR

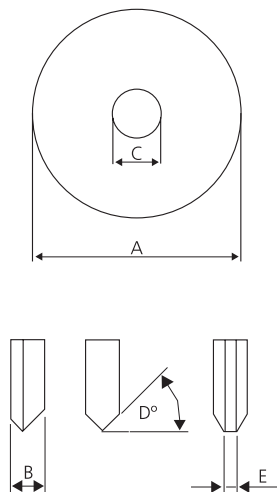

CODE	AxBxC	D	E	MAT.	PARA-FOR
FP1	25x10x10	50	0	HSS	OREGON
FP2W	40x6x10	35	0,1	W	VIRGINIA
FP3	50x6x12	45	0,15	HSS	KIS
FP4	53x6,3x12	45	0,1	HSS	KIS
FP5	57x5x12,7	45	0,15	HSS	JMA
FP6	60x5x12,7	42	0,1	HSS	SPRINT
FP11	63x5x16	42	0	HSS	ECCO/ECCO PLUS/ECCO AUTOMATIC
FP12	63x5x16	40	0,1	HSS	TUCSON
FP13	63x5x16-150D	42	0,1	HSS	DALLAS
FP14	70x13x7	45	0	HSS	LINCE CE-2
FP15	70x13x7-110	55	0	HSS	LINCE CM-1
FP16	70x5,25x16	40	0,1	HSS	PROCEDURE
FP16W	70x5,25x16	40	0,1	W	PROCEDURE
FP24	80x5x16	42	0,15	HSS	DAKOTA EXTRA/SARATOGA/NEVADA DENVER/TITAN/TITAN MASTER
FP25	80x5x16, 30	42,3	0,15	HSS	DAKOTA EXTRA/SARATOGA/TITAN/TITAN MASTER
FP41	80x8x16	50	12	HSS	CODE-ADAPTER DAKOTA/TITAN/SARATOGA
FP42	80x8x16	45	0,85	HSS	CODE-ADAPTER DAKOTA/TITAN/SARATOGA
FP43	80x8x16	45	1,55	HSS	CODE-ADAPTER DAKOTA/TITAN/SARATOGA
FP44	80x8x16	52,5	0,15	HSS	CODE-ADAPTER DAKOTA/TITAN/SARATOGA
FP49	80x8x16	45	0,4	HSS	CODE-ADAPTER DAKOTA/TITAN/SARATOGA
FP50	80x8x16	50	0,4	HSS	CODE-ADAPTER DAKOTA/TITAN/SARATOGA

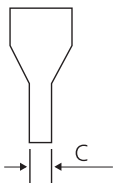
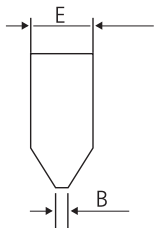
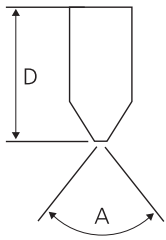

CODE	A	B	C	D	E	MAT.	PARA-FOR
F1	90	0,8		45	6	HSS	DAKAR / DAKAR EXPRESS / DAKKI / DAYTONA / COLUMBIA- ALBANY / ARIZONA / X-CODE
F1W	90	0,8		45	6	W	
F1A	90	0,8		45	8	HSS	
F3			1,5	45	6	HSS	
F3W			1,5	45	6	W	
F4	90	0,4		45	6	HSS	
F5	90	0,9		45	6	HSS	
F5W	90	0,9		45	6	W	
F6	106	1		45	6	HSS	
F7	70	0,8		45	6	HSS	
F8			4	45	6	HSS	
F8W			4	45	6	W	
F11			2,5	45	6	HSS	
F11W			2,5	45	6	W	
F12A	100	0,6		45	6	HSS	
F12B	100-90	2,1-2,9		45	6	HSS	
F13	100	0,8		45	6	HSS	
F13W	100	0,8		45	6	W	
F14	100	1,45		45	6	HSS	
F15 CON PLANTILLAS		2	5	45	6	HSS	
F16	130	0,6		45	6	HSS	
F17			3	45	6	HSS	
F17W			3	45	6	W	
F19	90	1,2		45	6	HSS	
F21	85	0,72		45	6	HSS	
F22			2,4	45	6	HSS	
F23W	90	0,8	3,3	45	6	W	
F24	95	1		45	6	HSS	
F24W	95	1		45	6	W	
F25	95	1,1		45	6	HSS	
F25W	95	1,1		45	6	W	
F26	90	0,6		45	6	HSS	
F27	90	0,7		45	6	HSS	
F27W	90	0,7		45	6	W	
F30	90	3	3	45	6	HSS	
F32	90	0,6	3	45	6	HSS	
F32W	90	0,6	3	45	6	W	
F33			2	45	6	HSS	
F33W			2	45	6	W	
F34	90	1,4		45	6	HSS	
F43	90	0,7		45	6	HSS	
FB	90-90	2,7-3,3		45	6	HSS	
FC	80-80			45	6	HSS	

F9			5,95	45	6	HSS	CHICAGO
F9W			5,95	45	6	HSS	

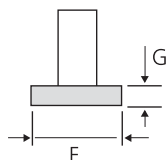

CODE	A	B	C	D	E	MAT.	PARA-FOR
F18	10	1		45	6	HSS	DAKAR-DAKAR EXPRESS- DAKKI-DAYTONA-COLUMBIA- ALBANY-ARIZONA
F20	16	1,25		45	6	HSS	

• Catálogo especialista de máquinas duplicadoras

• Key cutting specialist's guide

• Spécialiste catalogue de machines duplicatrices

• Spezialistkatalog

• Guida alla duplicazione

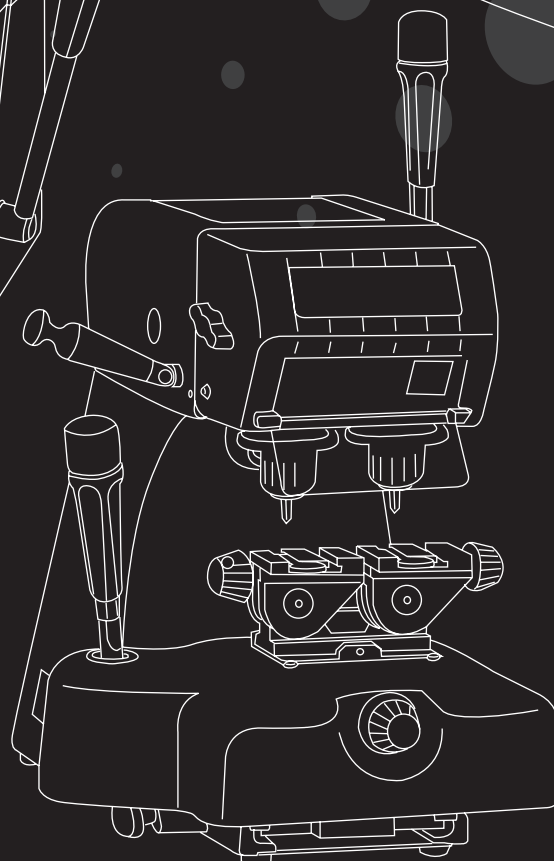
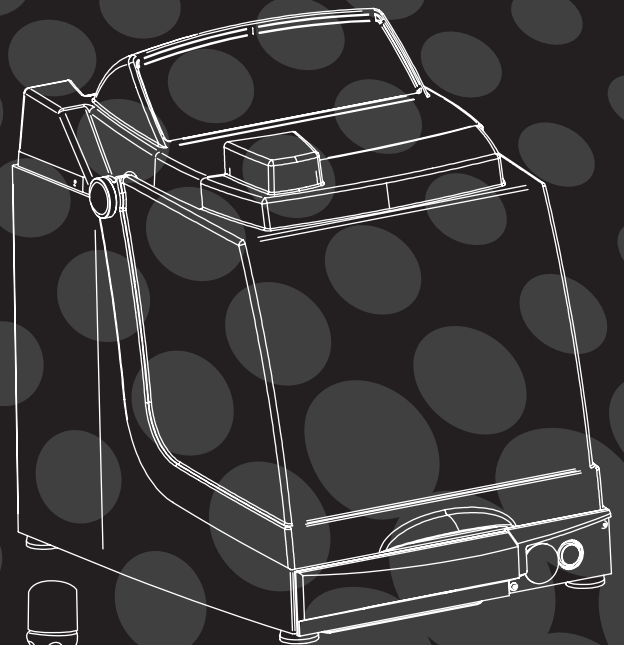
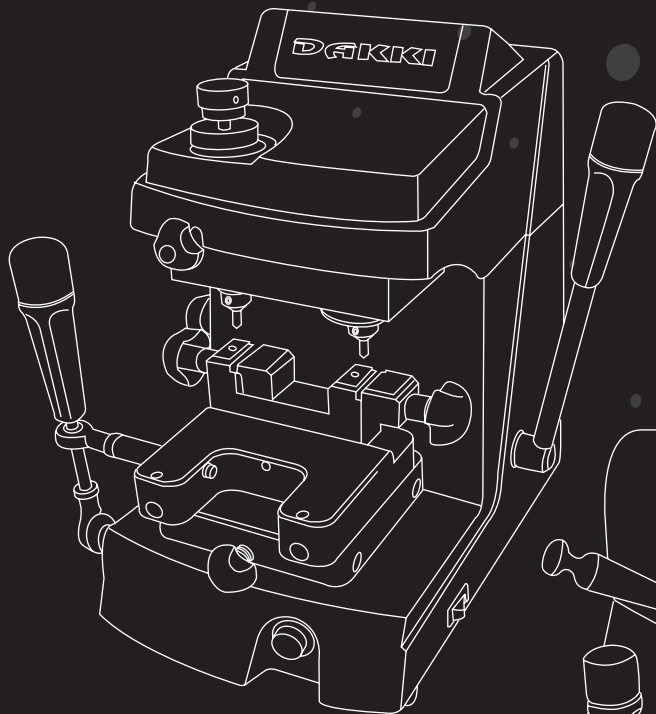

E Las ilustraciones y los datos técnicos de los productos en ese catálogo son indicativos. J.M.A. se reserva el derecho, quedando invariables las características principales de los productos, de modificar, sin advertencia previa, todo lo que considere necesario para mejorar la calidad de sus artículos o por exigencias productivas y comerciales. Todos los dibujos y las fotografías pertenecen a J.M.A.; según determina la Ley, se prohíbe toda reproducción aunque parcial, sin autorización por escrito de J.M.A. En caso de disputas la competencia es de las autoridades judiciales donde está domiciliada la firma, excluyendo cualquier otro fuero.

.....

EN All information and illustrations in this catalogue are for guidance only. J.M.A. reserve the right to alter designs, dimensions or prices without prior notice. The contents of this catalogue are fully protected by copyright and may not be copied or reproduced in any form without written permission from J.M.A. Any infringements will be dealt with under law.

.....

F Les illustrations et les caractéristiques techniques des produits présentés dans ce catalogue sont données à titre indicatif. Bien que les caractéristiques essentielles des produits soient invariables. J.M.A. se réserve le droit d'apporter toutes les modifications qu'elle retiendra nécessaires afin d'améliorer la qualité de ses produits dans le cas d'exigences de fabrication et commerciales. Tous les dessins et photos sont propriété J.M.A. et toute reproduction, même partielle, sans l'autorisation écrite préalable de J.M.A. est interdite conformément prescriptions légales. Tout litige est du ressort exclusif des Tribunaux de la circonscription où se trouve le Siège de la Société.

.....

D Die Abbildungen und technischen Daten des Katalogs sind nur zur Information. J.M.A. behält sich vor, etwaige Änderungen am Produkt, die zur Verbesserung desselben beitragen, ohne vorhergehende Ankündigung vorzunehmen. Alle Zeichnungen und Fotos sind Besitz der Firma J.M.A., jede Reproduktion, auch teilweise, ist ohne schriftliche Erlaubnis der Firma J.M.A. gesetzlich untersagt. Im Falle von Streitfragen ist der Gerichtshof des Firmensitzes zuständig; jeder andere Gerichtshof ist ausgeschlossen.

.....

I Le illustrazioni e i dati tecnici dei prodotti contenuti nel catalogo debbono considerarsi indicativi. J.M.A. si riserva il diritto, ferme restando le caratteristiche essenziali dei prodotti, di apportare tutte le modifiche che ritiene opportune, senza preavviso, al fine di migliorare la qualità dei prodotti o per esigenze produttive e commerciali. Tutti i disegni e le fotografie sono di proprietà di J.M.A., ogni riproduzione anche parziale, senza autorizzazione scritta della J.M.A. è vietata secondo termini di legge. Per qualsiasi controversia competenti sono gli Uffici Giudiziari dove ha sede l'Azienda, con espressa esclusione di qualsiasi altro foro.

.....

ABUS



 ABU-61

 ABU-63

 ABU-66

DAKAR – DAKAR EXPRESS

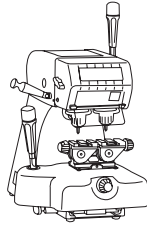

 OPTIONAL COPY

DAKKI

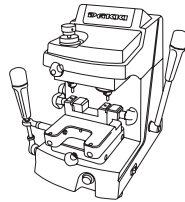

 OPTIONAL COPY



F1



P1

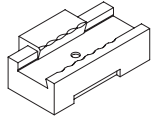

AD-CI

COLUMBIA

DAYTONA

AGA

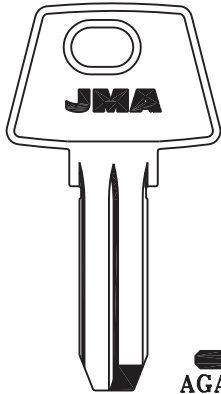

 AGA-25

DAKAR – DAKAR EXPRESS

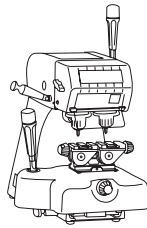

 STANDARD COPY

 OPTIONAL COPY
DAKAR EXPRESS

DAKKI

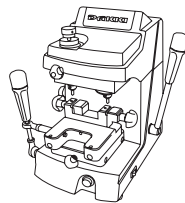

 OPTIONAL COPY



F13



P13

COLUMBIA

DAYTONA

DAKAR – DAKAR EXPRESS

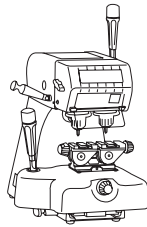

 OPTIONAL COPY

DAKKI

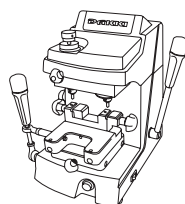

 OPTIONAL COPY



F5



P5

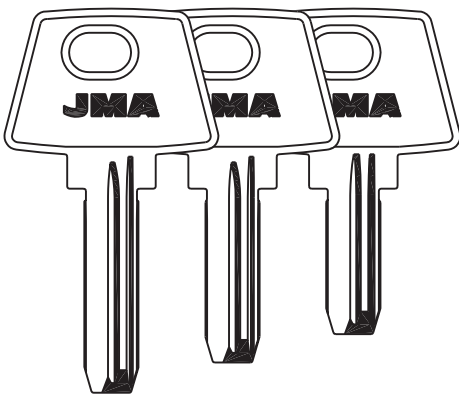

 AGA-42  AGA-43  AGA-44

COLUMBIA

DAYTONA

AGB

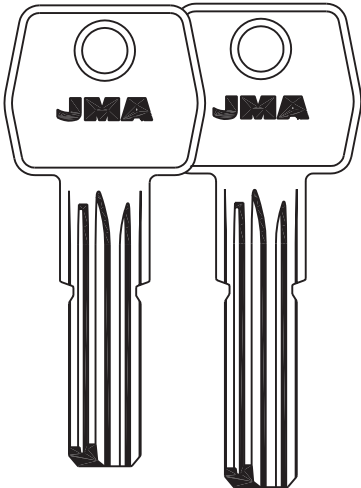

JMA
AGB-4

JMA
AGB-5

DAKAR – DAKAR EXPRESS

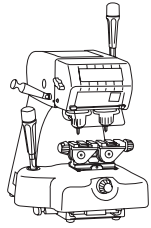

DAKKI

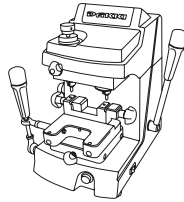

COLUMBIA

DAYTONA



F1



P1

AMIG

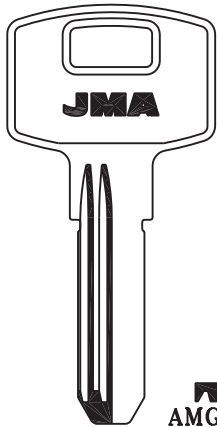

JMA
AMG-10D

DAKAR – DAKAR EXPRESS

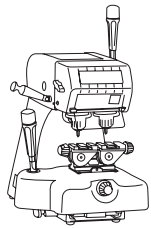

DAKKI

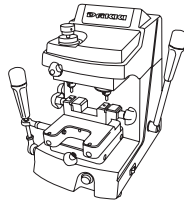

COLUMBIA

DAYTONA



F5



P5

APEX

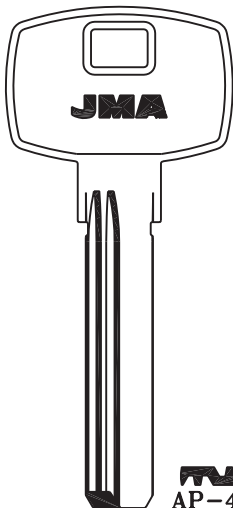

JMA
AP-4D

DAKAR – DAKAR EXPRESS

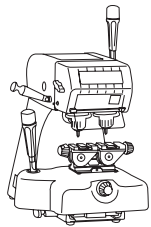

DAKKI

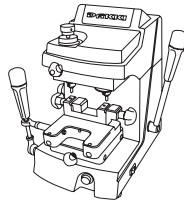

COLUMBIA

DAYTONA



F13



P13

AXA

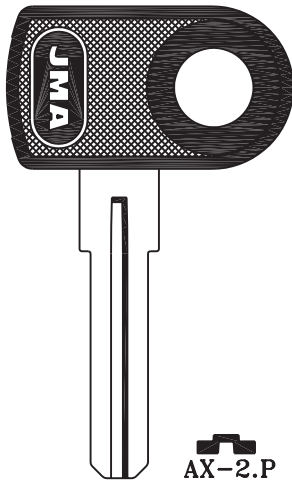

AX-2.P

DAKAR – DAKAR EXPRESS

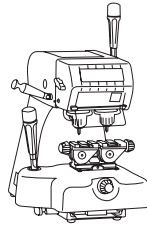

DAKKI

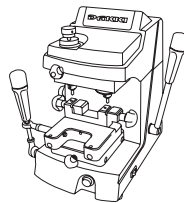

F1



P1

COLUMBIA

DAYTONA

AZBE

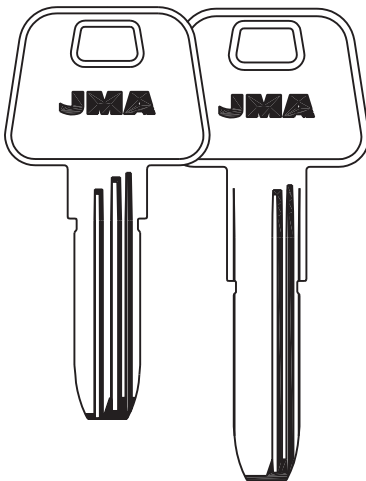

AZ-29

AZ-32

DAKAR – DAKAR EXPRESS

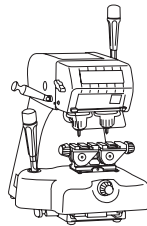

DAKKI

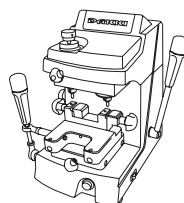

F13



P13

COLUMBIA

DAYTONA

BEY

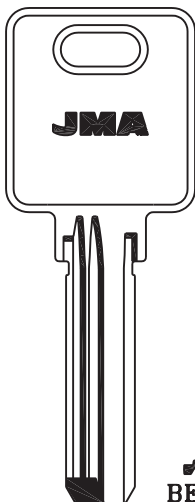

BEY-2D

DAKAR – DAKAR EXPRESS

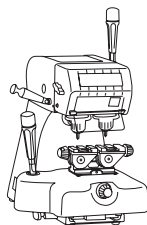

DAKKI

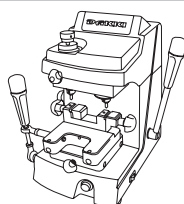

F19

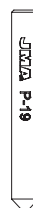

P19

COLUMBIA

DAYTONA

BRICARD

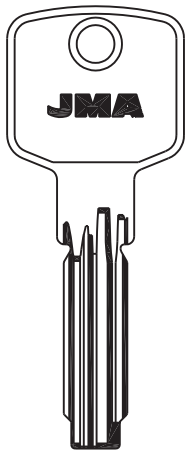

JMA
BRI-26

JMA
BRI-28

JMA
BRI-29

JMA
BRI-31

JMA
BRI-33

DAKAR – DAKAR EXPRESS

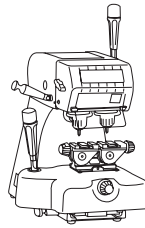

DAKKI

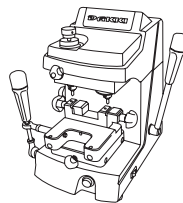

F1



P1

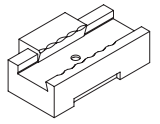

AD-CI

COLUMBIA

DAYTONA

BULAT

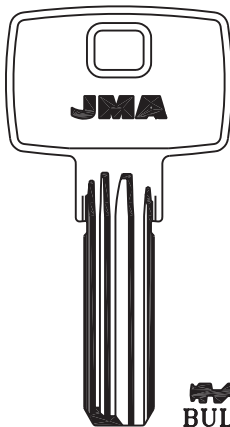

JMA
BUL-1

DAKAR – DAKAR EXPRESS

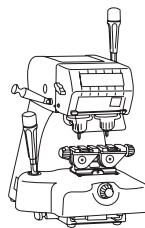

DAKKI

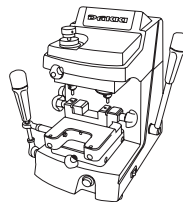

F1



P1

COLUMBIA

DAYTONA

BYP

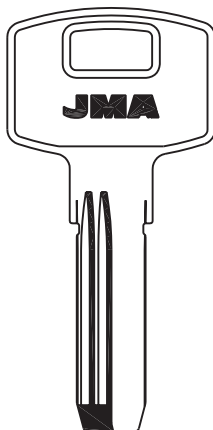

JMA
BYP-1D

DAKAR – DAKAR EXPRESS

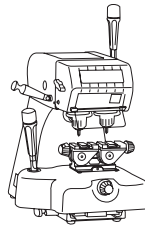

DAKKI

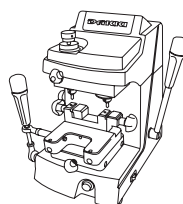

F19



P19

COLUMBIA

DAYTONA

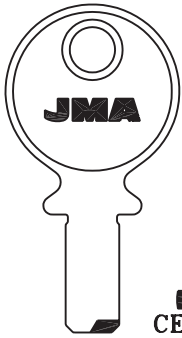

CE-114

DAKAR – DAKAR EXPRESS

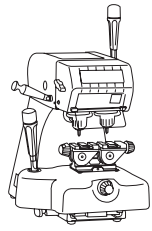

DAKKI

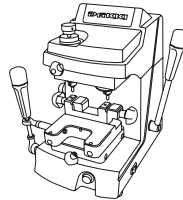

COLUMBIA

DAYTONA

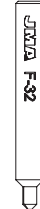

F32

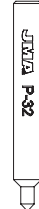

P32

XCODE

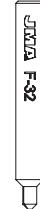
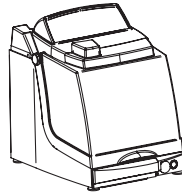

F32

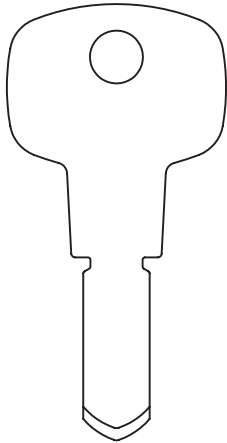

WSM

DAKAR – DAKAR EXPRESS

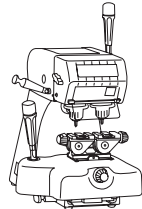

DAKKI

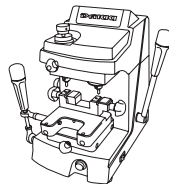

COLUMBIA

DAYTONA



F32



P32



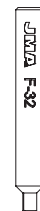





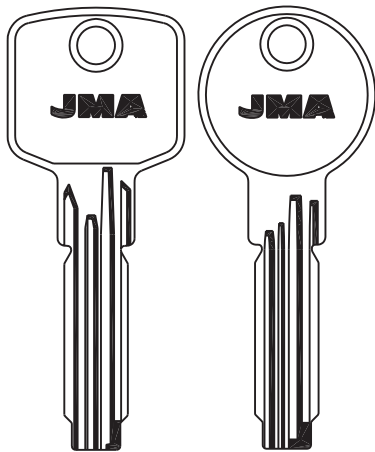



XCODE (Password Protected– CES authorization)



F32

CISA



-  CI-21
-  CI-32
-  CI-57
-  CI-25
-  CI-33
-  CI-26
-  CI-35
-  CI-30
-  CI-56
-  CI-31
-  CI-59
-  CI-60

DAKAR – DAKAR EXPRESS

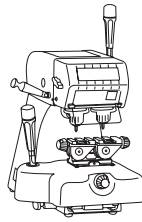

DAKKI

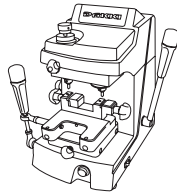

COLUMBIA

DAYTONA



F1



P1

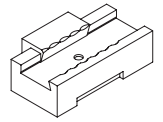

AD-CI

XCODE

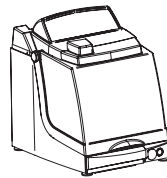

F1

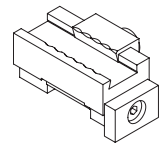

AD-X03

CORBIN

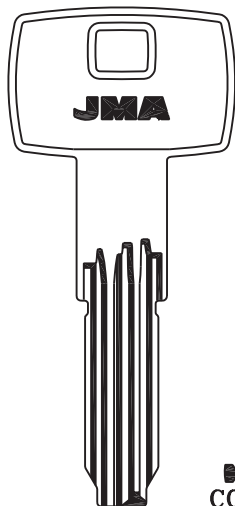

 COR-77

DAKAR – DAKAR EXPRESS

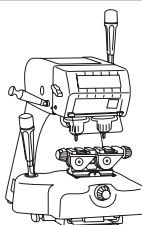

DAKKI

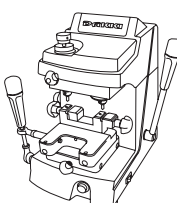

COLUMBIA

DAYTONA



F5



P5

DAF

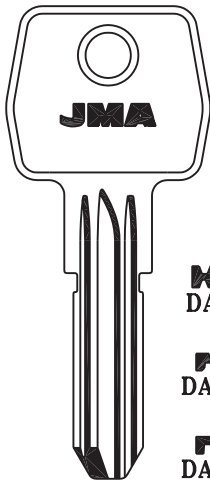

DAF-2

DAF-3D

DAF-4D

DAKAR – DAKAR EXPRESS

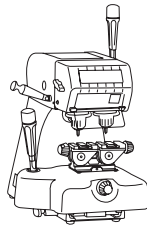

STANDARD COPY

OPTIONAL COPY
DAKAR EXPRESS

DAKKI

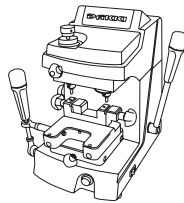

OPTIONAL COPY

COLUMBIA

DAYTONA



F13



P13

DEKABA

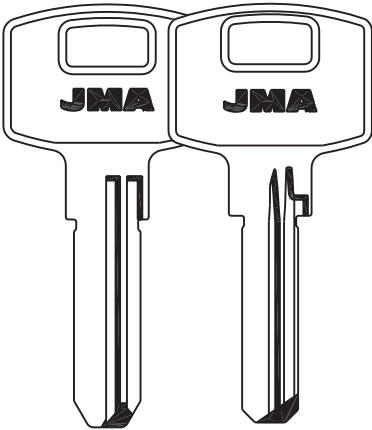

DEK-3

DEK-4

DEK-8

DAKAR – DAKAR EXPRESS

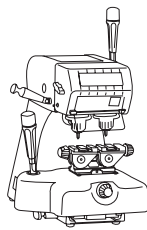

STANDARD COPY

DAKKI

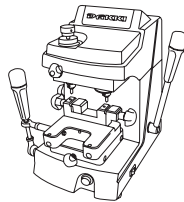

STANDARD COPY

COLUMBIA

DAYTONA



F1



P1

DELCA

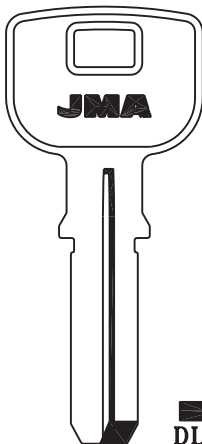

DLC-3

DAKAR – DAKAR EXPRESS

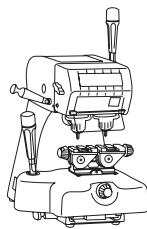

STANDARD COPY

DAKKI

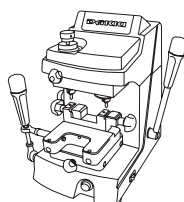

STANDARD COPY

COLUMBIA

DAYTONA



F1



P1

DOM

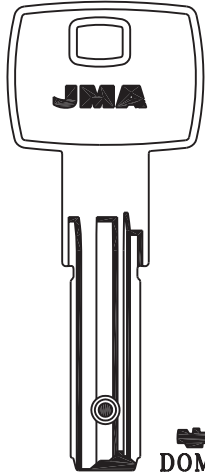

DOM-B1

DAKAR – DAKAR EXPRESS

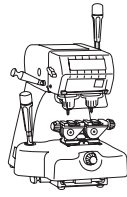

DAKKI

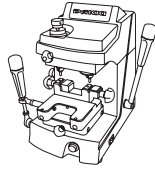

COLUMBIA

DAYTONA



F1



P1

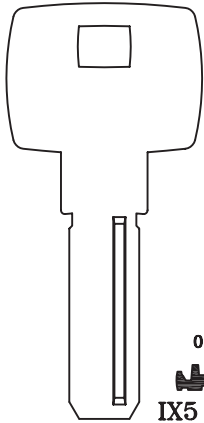

038
IX5 DAS

DAKAR – DAKAR EXPRESS

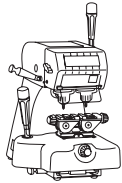

DAKKI

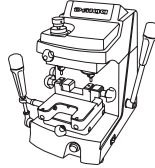

COLUMBIA

DAYTONA



F1



P1

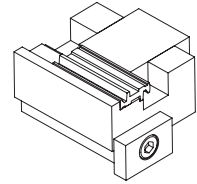

AD-DO

XCODE (Password Protected– DOM authorization)



F1

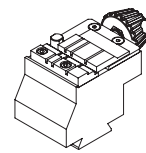

M4

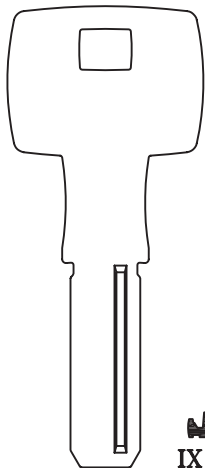

138
IX DAS

DAKAR – DAKAR EXPRESS



DAKKI

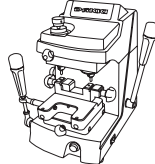

COLUMBIA

DAYTONA



F23



P23

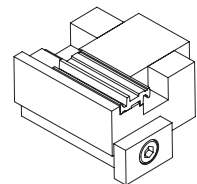

AD-DO

XCODE (Password Protected– DOM authorization)



F23

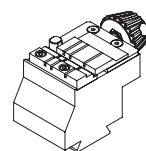

M4

DOM

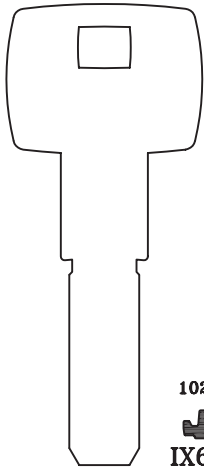

102/121
IX6 KG



DAKAR – DAKAR EXPRESS

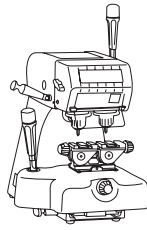

DAKKI

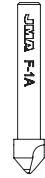
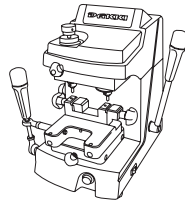

F1A



P1

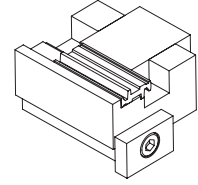

AD-DO

COLUMBIA

DAYTONA

XCODE (Password Protected– DOM authorization)

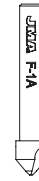
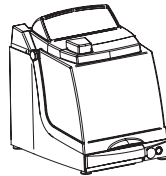

F1A

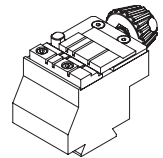

M4

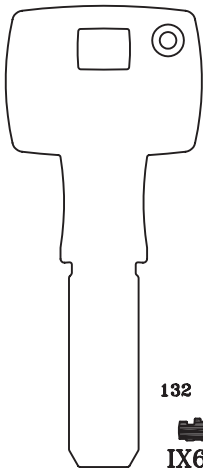

132 / 232
IX6 SR



DAKAR – DAKAR EXPRESS



DAKKI

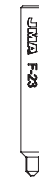
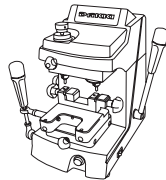

F23

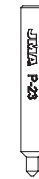

P23

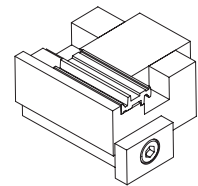

AD-DO

COLUMBIA

DAYTONA

XCODE (Password Protected– DOM authorization)



F23

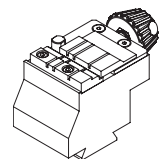

M4

FAYN

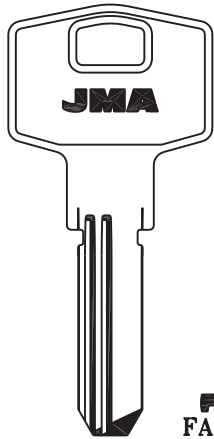

FAY-1D

DAKAR – DAKAR EXPRESS

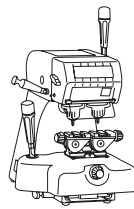

DAKKI

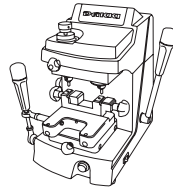

COLUMBIA

DAYTONA



F5



P5

FICHET

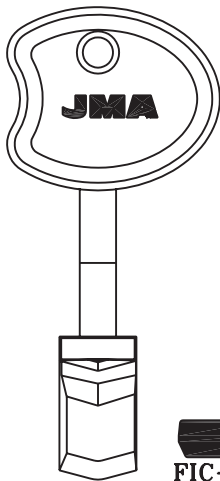

FIC-18

DAKAR – DAKAR EXPRESS

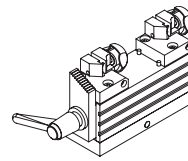
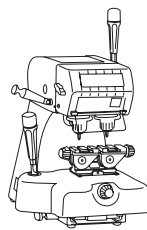

FIC 18-DA

COLUMBIA

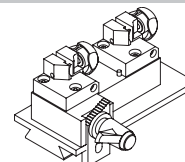

FIC 18-CO

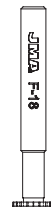

F18

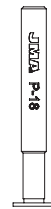

P18

FTH

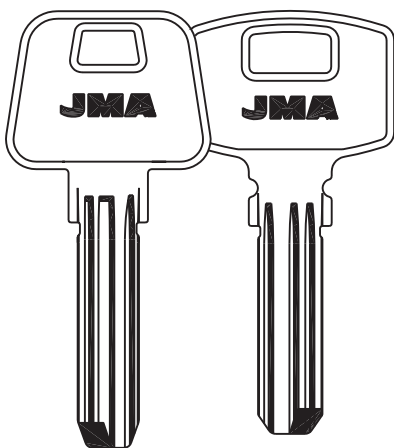

FTH-23

FTH-24

DAKAR – DAKAR EXPRESS

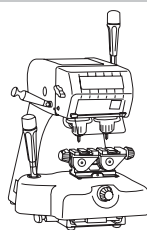

DAKKI

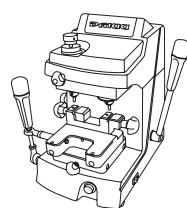

COLUMBIA

DAYTONA



F5



P5

FTH

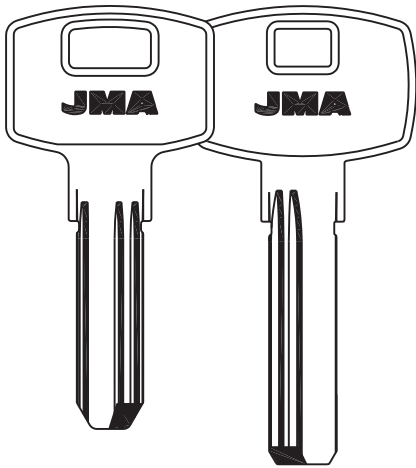

FTH-25

FTH-26D

DAKAR – DAKAR EXPRESS

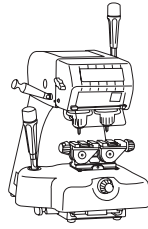

DAKKI

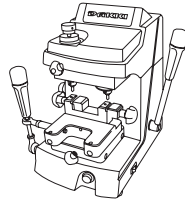

COLUMBIA

DAYTONA



F5



P5

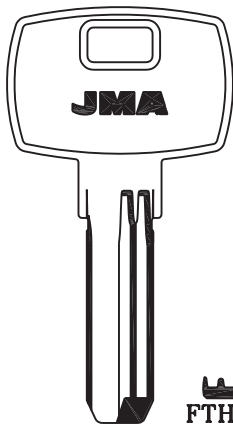

FTH-29

DAKAR – DAKAR EXPRESS

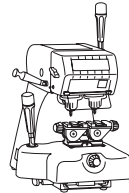

DAKKI

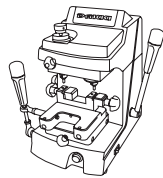

COLUMBIA

DAYTONA



F5



P5

GERDA

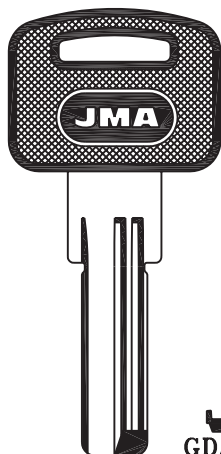

GDA-1.P

DAKAR – DAKAR EXPRESS

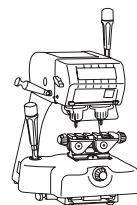

DAKKI

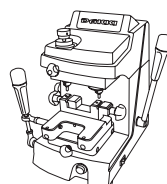

COLUMBIA

DAYTONA



F1



P1

HUF

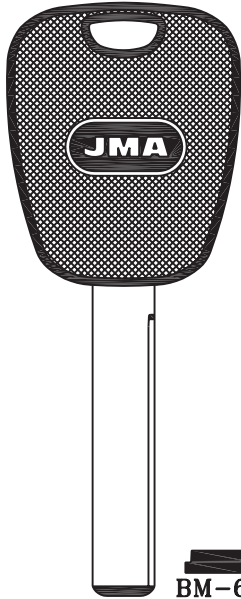

BM-6.P

DAKAR – DAKAR EXPRESS

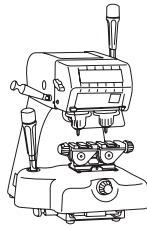

DAKKI

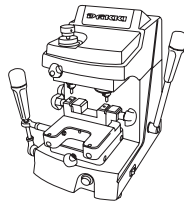

COLUMBIA

DAYTONA

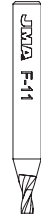

F11



P11

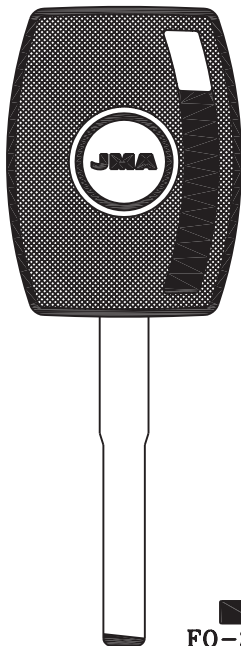

FO-24.P

DAKAR – DAKAR EXPRESS

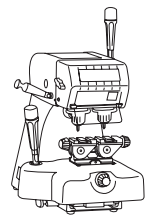

DAKKI

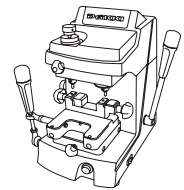

COLUMBIA

DAYTONA

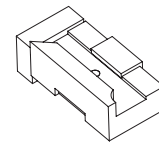

AD-FO24

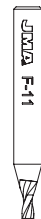

F11

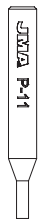

P11



FO-24C1



FO-24C2

XCODE

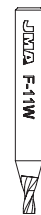
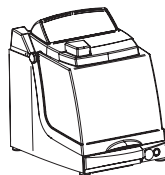

F11W

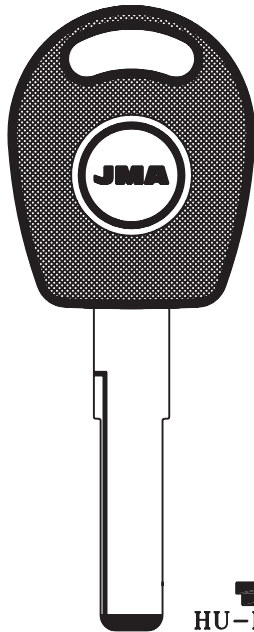

HU-HAA.P1

DAKAR – DAKAR EXPRESS

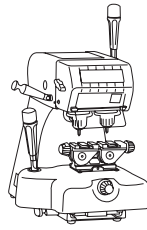

DAKKI

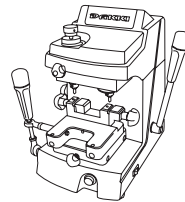

COLUMBIA

DAYTONA

XCODE

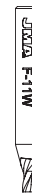
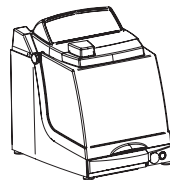

F11W

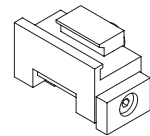

AD-AU

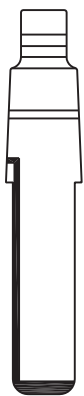

HU-HAAC1



HU-HAAC2

HU-NAAC2

DAKAR – DAKAR EXPRESS

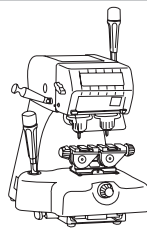

DAKKI

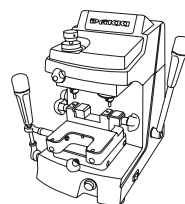

COLUMBIA

DAYTONA



F11



P11

HUF

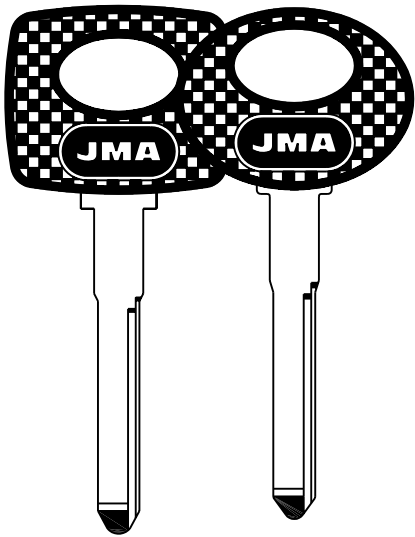

ME-4.P

ME-5.P

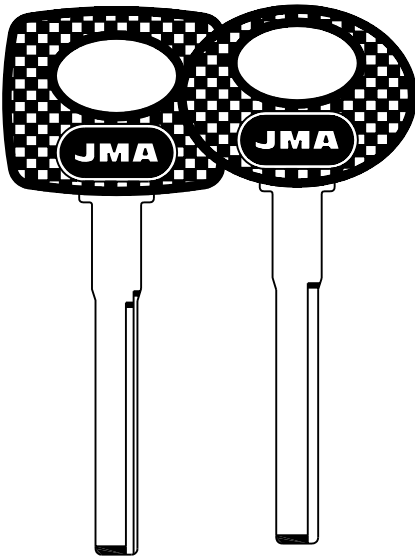

ME-10.P

ME-12.P

ME-11.P

DAKAR – DAKAR EXPRESS

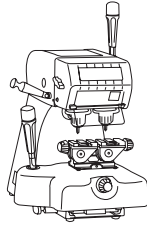

DAKKI

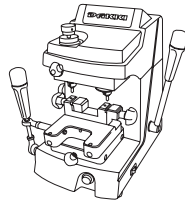

F11



P11

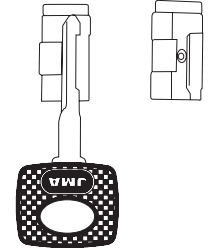

AD-MM

COLUMBIA

DAYTONA

XCODE

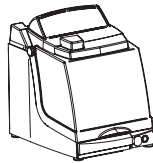

F11W

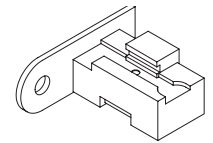

AD-X04

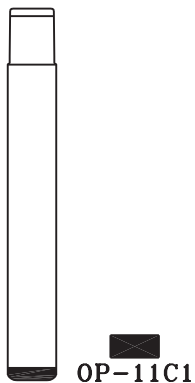

OP-11C1

DAKAR – DAKAR EXPRESS

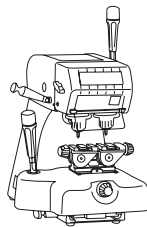

DAKKI

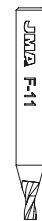
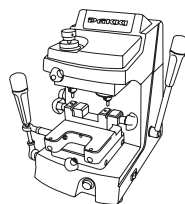

F11

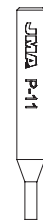

P11

COLUMBIA

DAYTONA

HUF



OP-WHC1

DAKAR – DAKAR EXPRESS

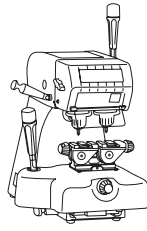

DAKKI

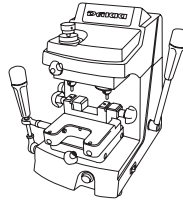

F11

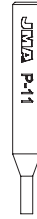

P11

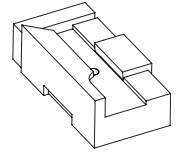

AD-OP

COLUMBIA

DAYTONA

IFAM

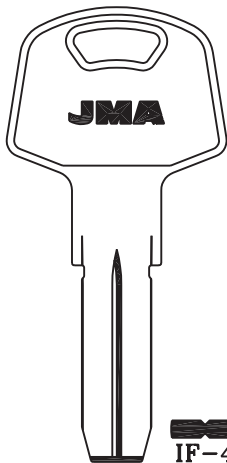

IF-4

DAKAR – DAKAR EXPRESS

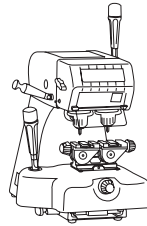

DAKKI

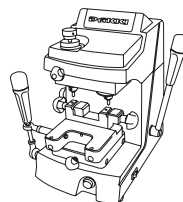

F1



P1

COLUMBIA

DAYTONA

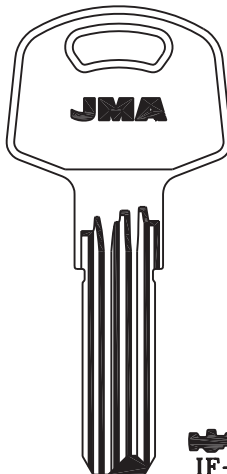

IF-6

DAKAR – DAKAR EXPRESS

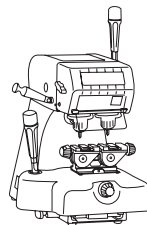

DAKKI

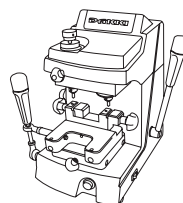

F19



P19

COLUMBIA

DAYTONA

ISEO

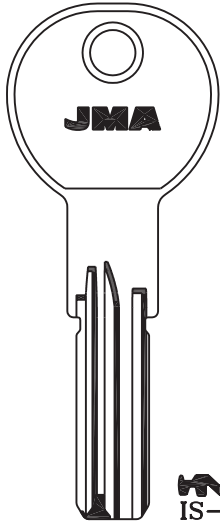

DAKAR – DAKAR EXPRESS

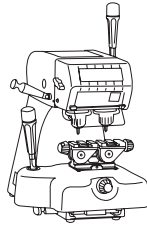

DAKKI

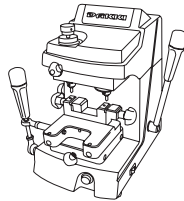

COLUMBIA

DAYTONA



F1



P1

KALE

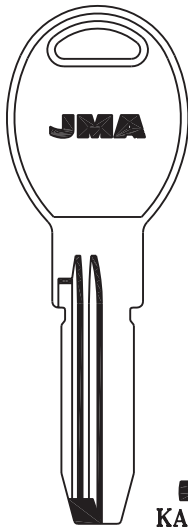

DAKAR – DAKAR EXPRESS

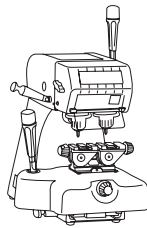

DAKKI

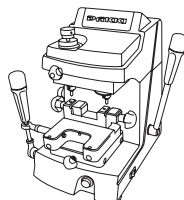

COLUMBIA

DAYTONA



F1



P1

MASTER LOCK

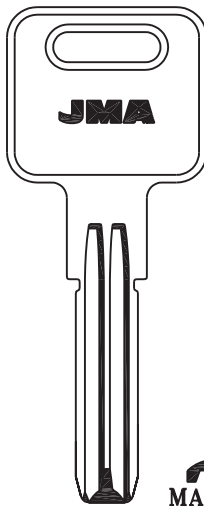

DAKAR – DAKAR EXPRESS

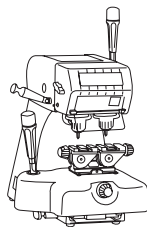

DAKKI

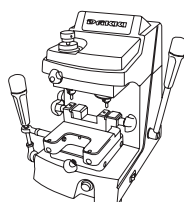

COLUMBIA

DAYTONA



F1



P1

MCM

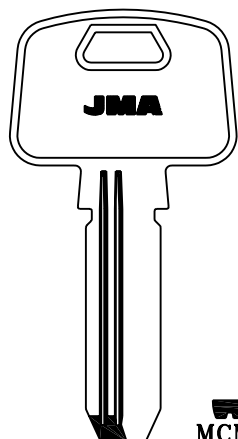

MCM-10

DAKAR – DAKAR EXPRESS

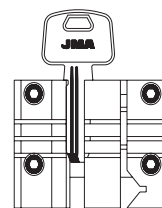
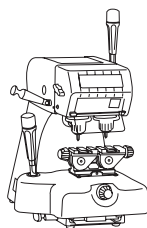

F13



P13

DAKKI

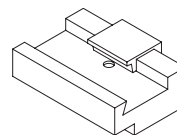
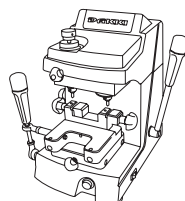

AD-MCM

COLUMBIA

DAYTONA

XCODE



F13

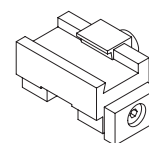

AD-X05

MSM

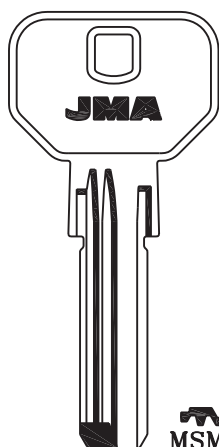

MSM-1

DAKAR – DAKAR EXPRESS

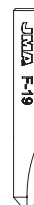
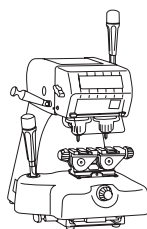

F19

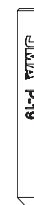

P19

DAKKI

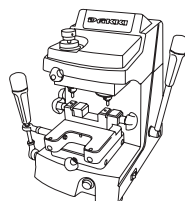

COLUMBIA

DAYTONA

MUL.T.LOCK

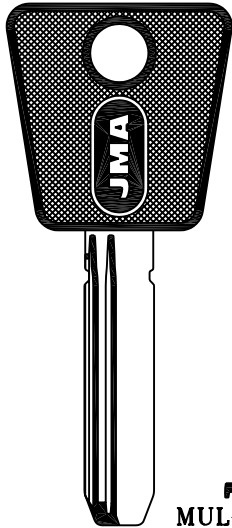

MUL-T10.P

DAKKI

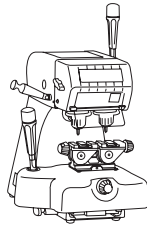

DAKKI

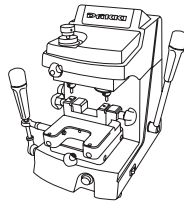

COLUMBIA

DAYTONA



F12A



F12B



P12A



P12B

POTENT

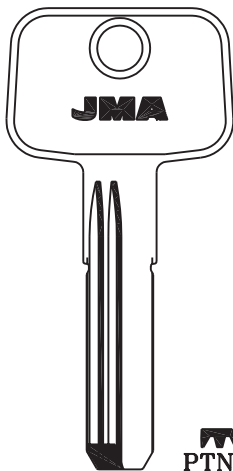

PTN-1D

DAKAR – DAKAR EXPRESS

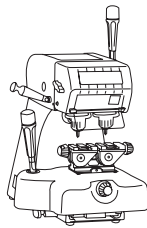

DAKKI

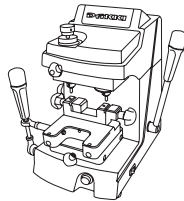

COLUMBIA

DAYTONA

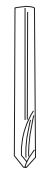

F5
F19

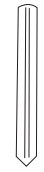

P5
P19

ROSSETTI

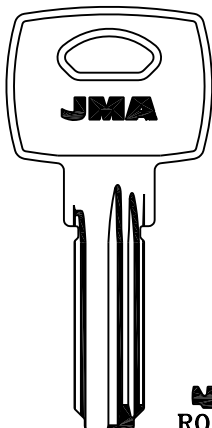

ROSE-1

DAKAR – DAKAR EXPRESS

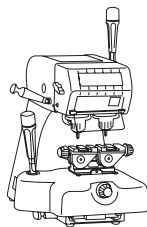

DAKKI

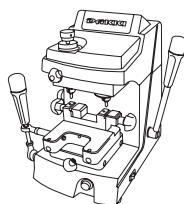

COLUMBIA

DAYTONA



F1

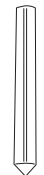

P1

STS

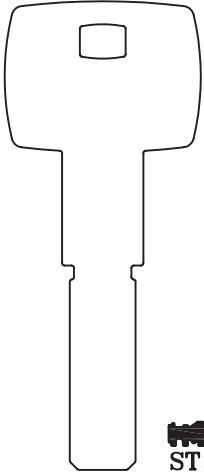

ST15

XCODE (Password Protected- STS authorization)

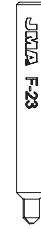
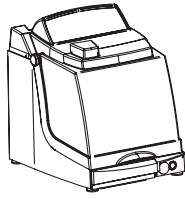

F23

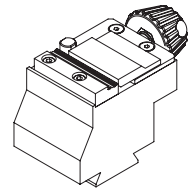

M5

SUBARU

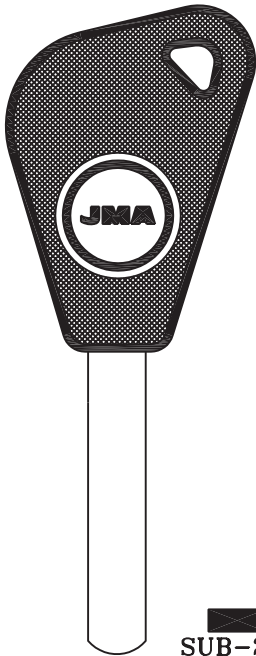

SUB-2.P

DAKAR – DAKAR EXPRESS

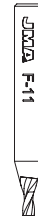
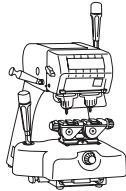

F11

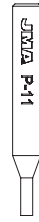

P11

DAKKI

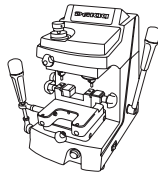

COLUMBIA

DAYTONA

XCODE



F11W

TARONI

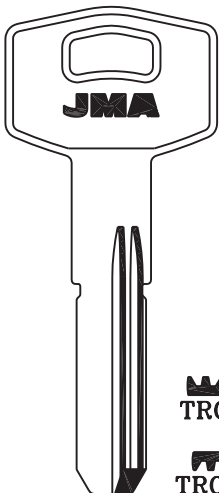

TRO-1

TRO-1D

DAKAR – DAKAR EXPRESS

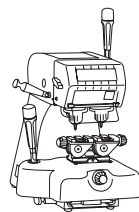

F1



P1

DAKKI

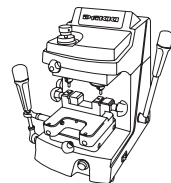

COLUMBIA

DAYTONA

TESA

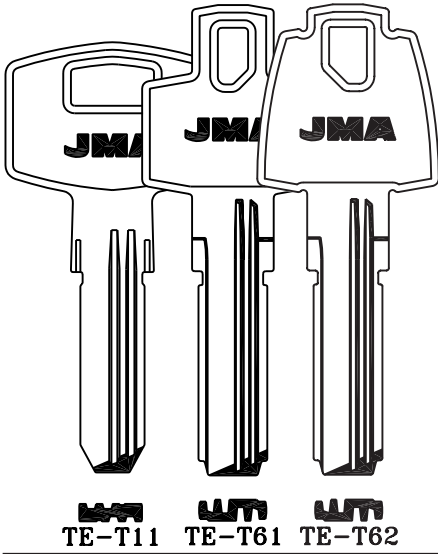

DAKAR – DAKAR EXPRESS

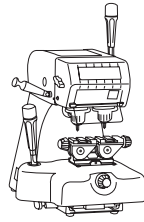

OPTIONAL COPY

DAKKI

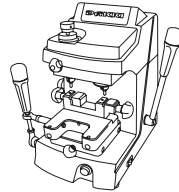

OPTIONAL COPY

COLUMBIA

DAYTONA



F5



P5

TOYOTA



TOYO-30.P1

DAKAR – DAKAR EXPRESS

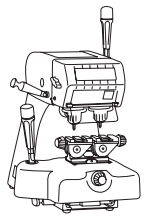

OPTIONAL COPY

DAKKI

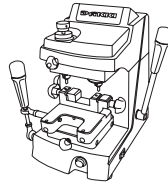

OPTIONAL COPY

COLUMBIA

DAYTONA

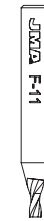

F11

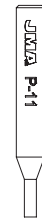

P11

TRW-SIPEA

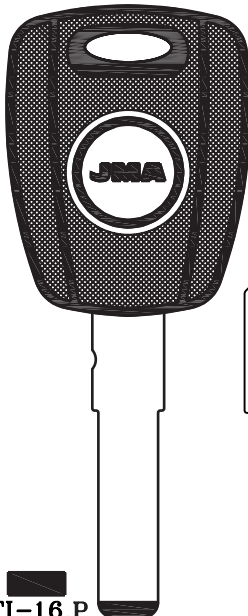

FI-16.P



FI-16C1

DAKAR – DAKAR EXPRESS

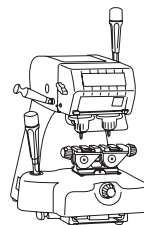

OPTIONAL COPY

DAKKI

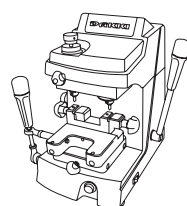

OPTIONAL COPY

COLUMBIA

DAYTONA

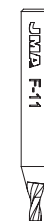

F11

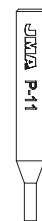

P11

URBIS

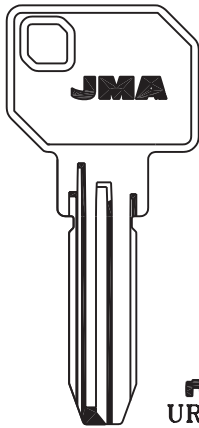

URB-3D

DAKAR – DAKAR EXPRESS

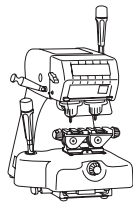

DAKKI

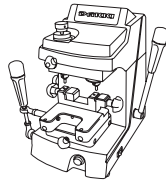

COLUMBIA

DAYTONA



F1



P1

VALEO



HU-HAAC3



HU-HAAC4

DAKAR – DAKAR EXPRESS

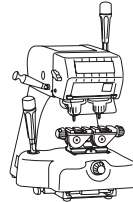

DAKKI

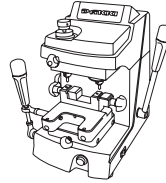

COLUMBIA

DAYTONA



F11



P11

XCODE

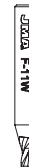

F11W

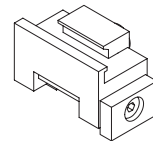

AD-AU



PEU-1C1

DAKAR – DAKAR EXPRESS

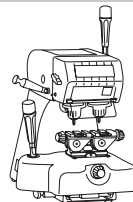

DAKKI

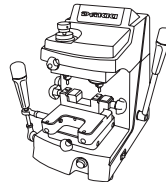

COLUMBIA

DAYTONA

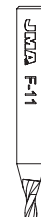

F11

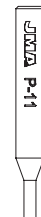

P11

VALEO

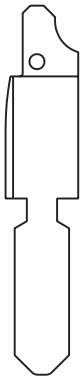

PEU-2C1

DAKAR – DAKAR EXPRESS

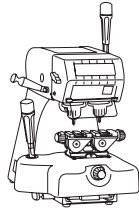

DAKKI

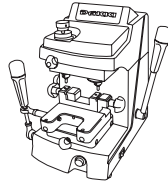

F11

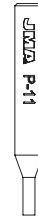

P11

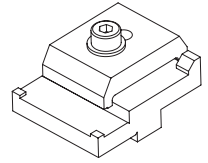

AD-MJ

COLUMBIA

DAYTONA

VIRO

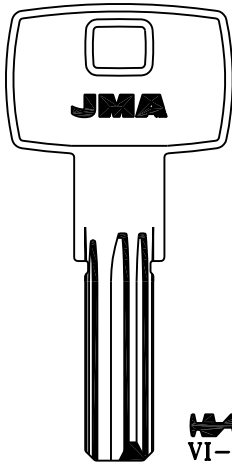

VI-14

DAKAR – DAKAR EXPRESS

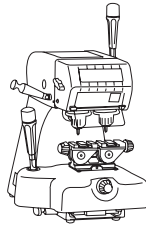

DAKKI

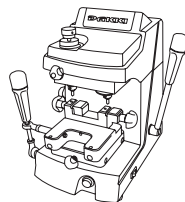

F1



P1

COLUMBIA

DAYTONA

YALE

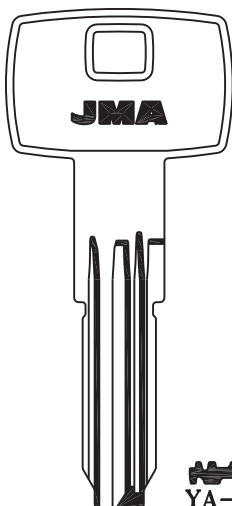

YA-81

DAKAR – DAKAR EXPRESS

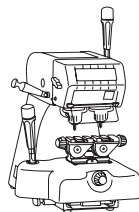

DAKKI

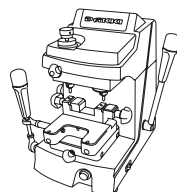

F1



P1

COLUMBIA

DAYTONA

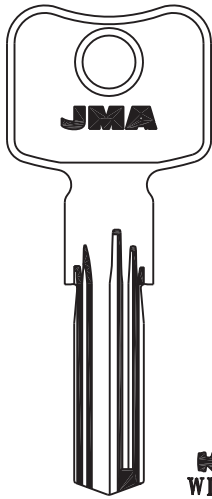

DAKAR – DAKAR EXPRESS

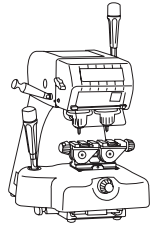

DAKKI

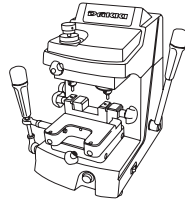

F1



P1

COLUMBIA

DAYTONA

XCODE



F1

MORDAZA A CÓDIGO – CODE CLAMP – ETAUX À CODE – KODE VORRICHTUNG – MORSETTO A CODICE

DAKOTA EXTRA - TITAN - TITAN MASTER

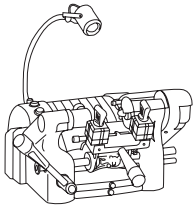

CODE → B

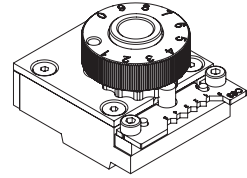

CODE → A

SARATOGA

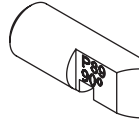
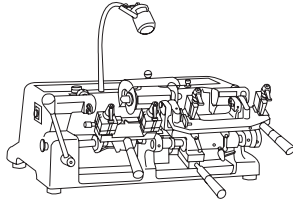

CODE → C

MARCA	LLAVE	MORDAZA (A)	FRESA (B)		PALPADOR (C)	
			SPECIAL	UNIVERSAL	SPECIAL	UNIVERSAL
ABUS	Original XP	AB-744	FP44		P84	
AZBE	AZ-1D AZ-11 AZ-17D	AZ-507		FP49		P89
FAB	FB-2D FB-2I FB-4 FB-5 FB-6 FB-7 FB-8 FB-9 FB-10 FB-11 FB-12 FB-13 FB-14 FB-15 FB-16 FB-17 FB-18 FB-26 FB-27 FB-28 FB-29 FB-30 FB-32	FB-489	FP41	FP50	P81	P90
GEGE	Pextra FLEX	RU-808		FP49		P89
RUKO	RU-5D RU-5I RU-6I RU-9D RU-9I RU-11D RU-12D RU-14D	RU-488	FP42	FP49	P82	P89
TESA	TE-8I	TE-476	FP43	FP49	P83	P89

UNIVERSAL:

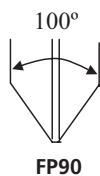
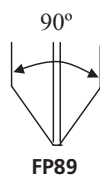

SPECIAL: Palpador y fresas con el perfil de corte.

Milling cutter and tester with the profile of the bitting.

JMA 
ALEJANDRO ALTUNA, S.A.

Bidekurtzeta, 6 Apdo. 70
20500 ARRASATE-MONDRAGÓN
(Gipuzkoa) ESPAÑA
Tel. + 34 943 79 30 00 / 79 33 32
Fax. + 34 943 79 72 43
<http://www.jma.es>
e-mail: jma@jma.es



Tél. 04 73 84 84 94