

SUPLEMENTO-SUPPLEMENT

JMA 

2009

PARA: ABLOY
FOR:

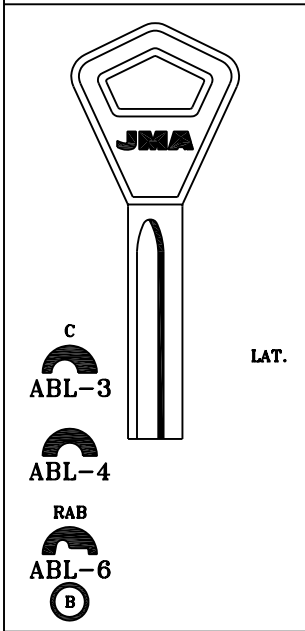

ABUS

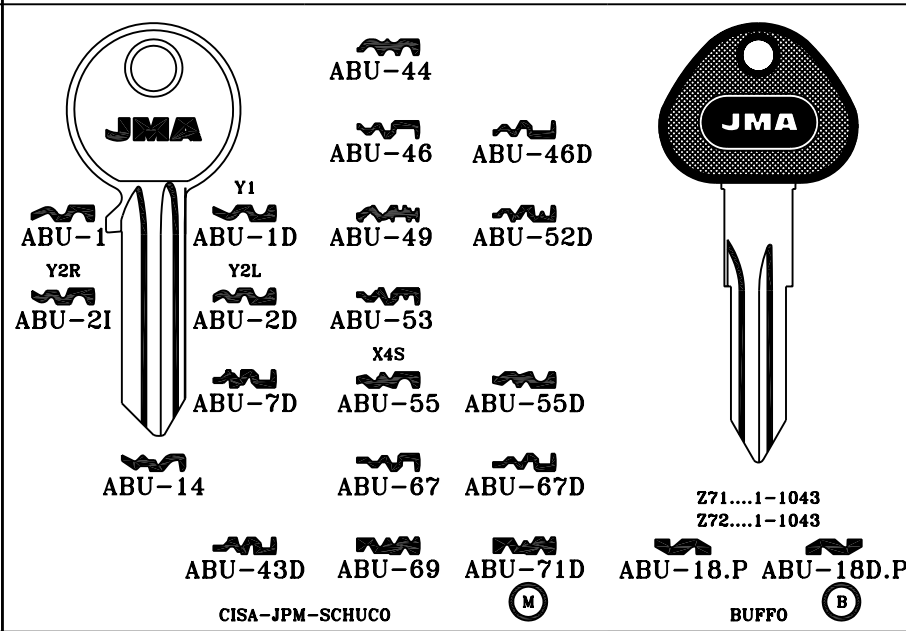

PARA-FOR:

ABLOY (SF)
ABUS (D)
BASI (D)
BKS (D)
BRABANTIA (E)
BSS (YU)
BYP
CLARK FORK L.
(USA)
DOM (D)

PARA: ABUS
FOR:

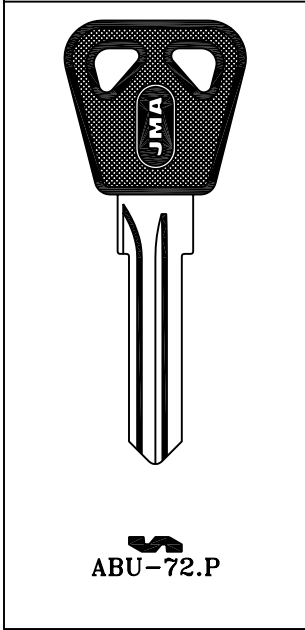

BASI

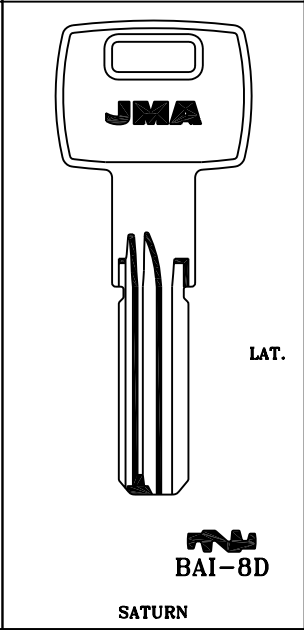

BKS

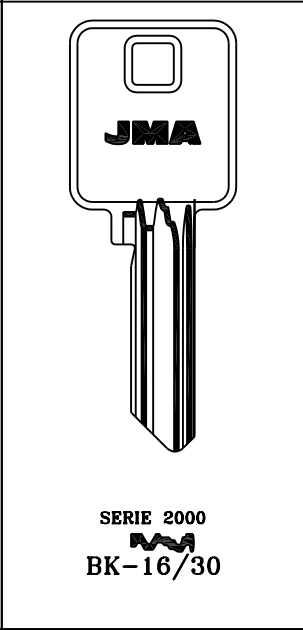

BRABANTIA

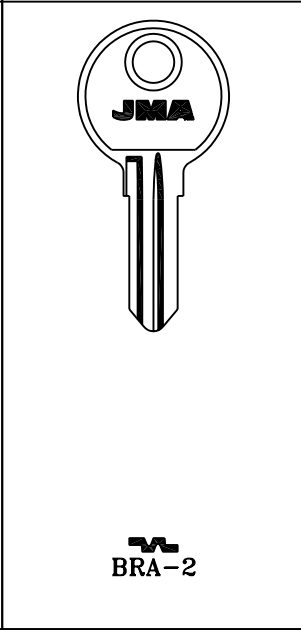

PARA: BSS
FOR:

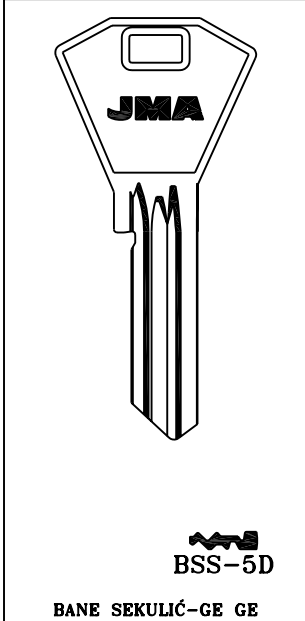

BYP

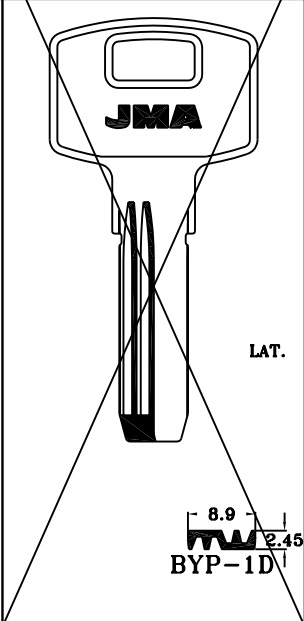

CLARK FORK L.

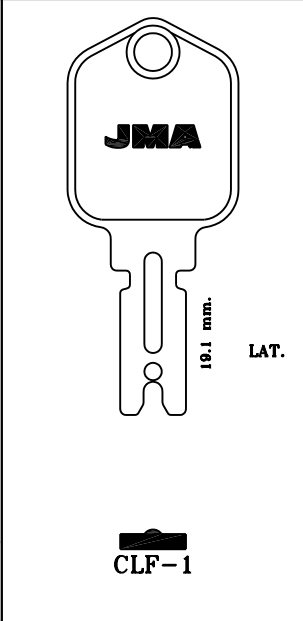

DOM

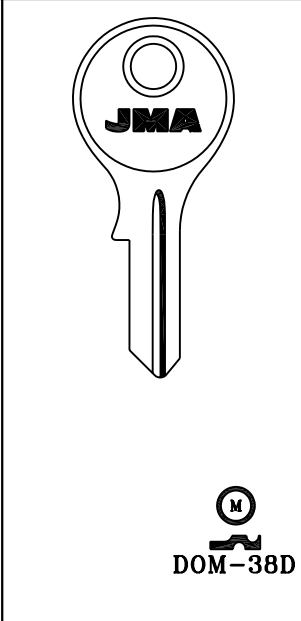

Copyright by
Alejandro Altuna S.A.
2009

JMA

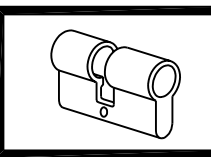

1

ATENCION:Concerniente a las marcas y denominaciones comerciales ver nota en indice.ATTENTION:Concerning the marks and commercial denominations see note in index.
ATTENTION:Concernant les marques et denominations commerciales voir la note dans l'index.ACHTUNG:Beziehen auf die marke und handelsname sehen sie die notiz im index.

PARA-FOR:

DOMUS (I-GR)





ESLA (GB)



GE GE (A)

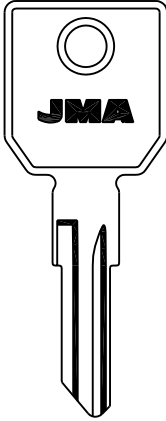
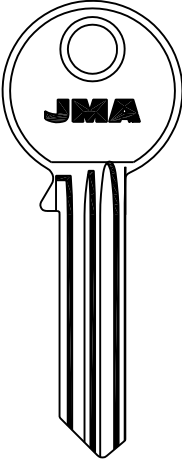
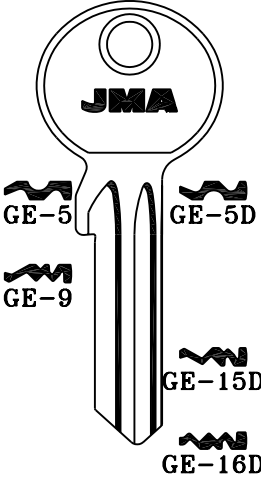
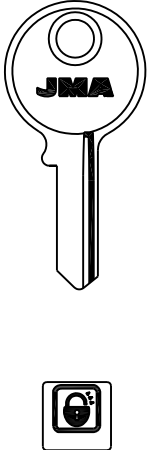

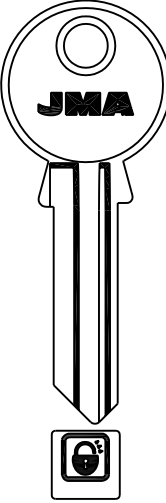
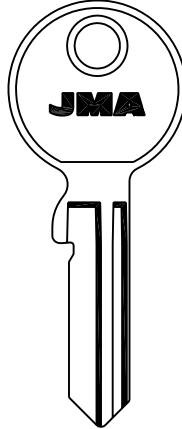
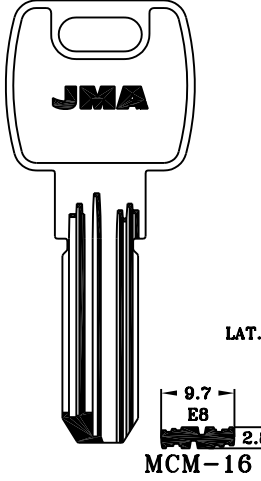
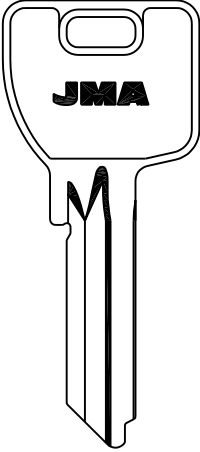
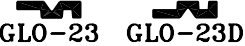

GLOBE (RC)

**JUNKUNC
(USA)**

MCM (E)

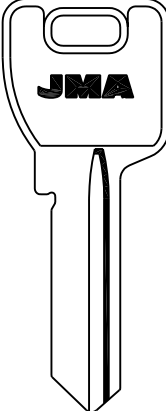
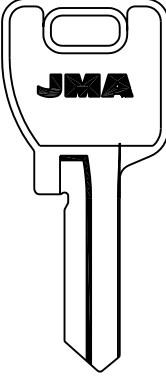
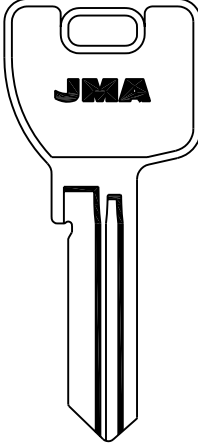
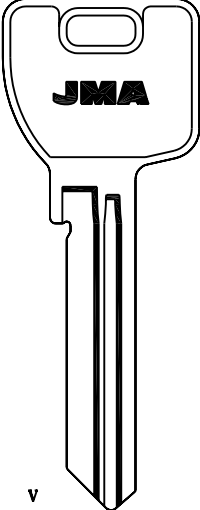
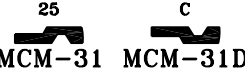
PARA: FOR:	DOMUS	ESLA	GE GE	GLOBE
				
	 DO-7	 ESL-1 ESL-1D ⓑ	 GE-19 GE-16D ⓑ	 GLO-22 GLO-22D GOLD DOOR

PARA: FOR:	GLOBE	JUNKUNC	MCM	
				
	 GLO-23 GLO-23D ANLO-LUCO	 JU-2 JU-2D 1 AL 8 ⓑ ALSO-A.MOTORS-BULIT-LION	 MCM-21D MCM-30D ⓑ	







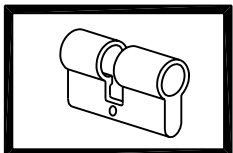



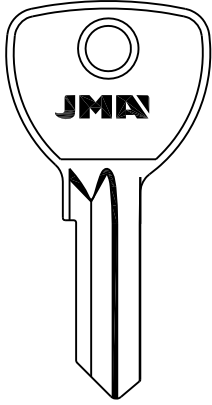

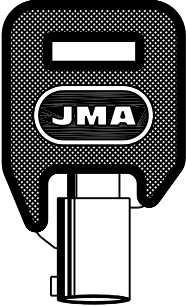

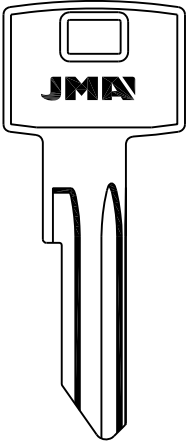









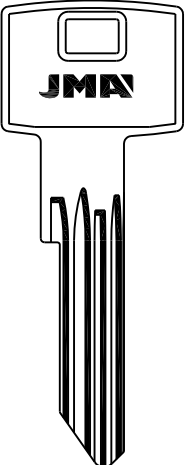



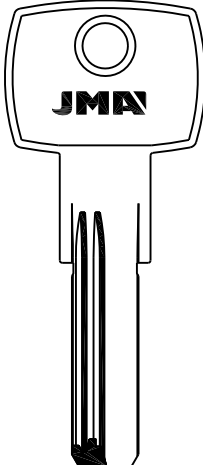

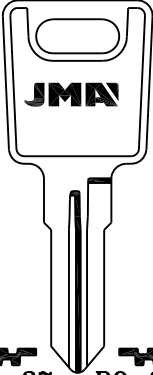



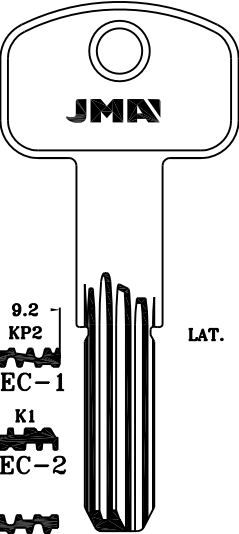
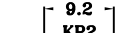

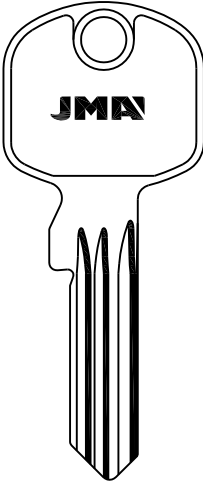

PARA: FOR:	MCM			
				
	 MCM-31 MCM-31D	 MCM-32D	 MCM-33	 MCM-35

Copyright by
Alejandro Alfuna S.A.
2009

JMA

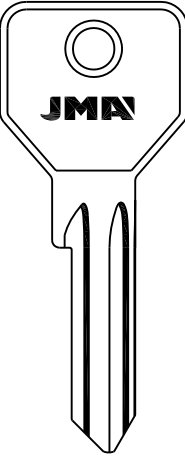

2

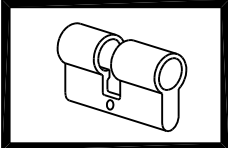

PARA: FOR:	OMEC	P.C.	PFAFFENHAIN		PARA-FOR:
	  OMC-6D	  PC-3T.P	  PFA-4  EA PFA-13D  EB PFA-14D  EH PFA-15D  A21 PFA-10D  A22 PFA-11D  A23 PFA-12D  EN PFA-16D  RF PFA-17D  RG PFA-18D (B)	OMEC (I) P.C. (I) PFAFFENHAIN (D) POTENT (I) RONIS (F) SECUREMME (I) STEM (D) STUBLINA (SCG)	
PARA: FOR:	PFAFFENHAIN	POTENT	RONIS		
	  A21 PFA-7D  A22 PFA-8D  A23 PFA-9D (B)	  P04..... 1-2-3-4-5-6 PTN-2D	  RO-37  RO-38  RO-41 (B)		
PARA: FOR:	STEM		STUBLINA		
  9.2 KP2 SEC-1  2.85 K1 SEC-2  2.37 SEC-3 LAT.	  STE-1	 STE-7  STE-6  STE-5D  STE-4  STE-3  STE-2D	  STB-1  STB-1D	<p>Copyright by Alejandro Altuna S.A. 2009</p>   <div style="border: 2px solid black; padding: 5px; text-align: center; font-size: 24px; font-weight: bold;">3</div>	

PARA-FOR:

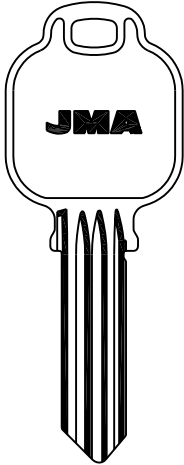
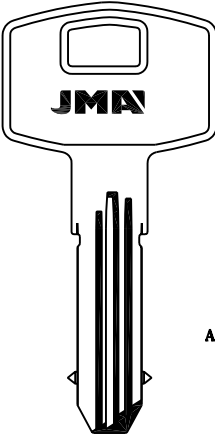
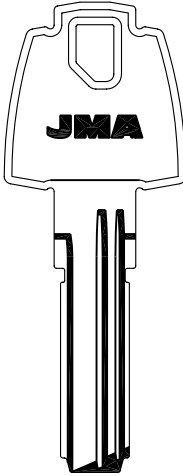
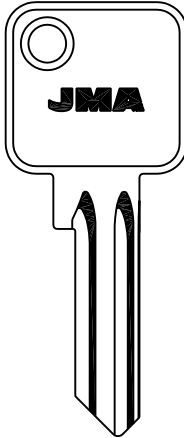
- T-KEY**
- TESA (E)**
- UNIVERSAL**
- URBIS (R)**
- VBH (D)**
- WINKHAUS (D)**
- YALE (D-GB-USA)**

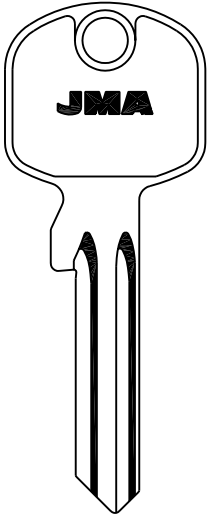
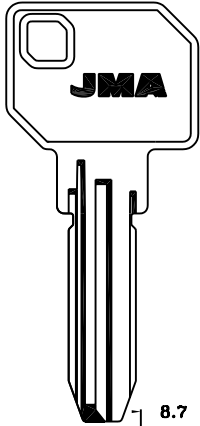
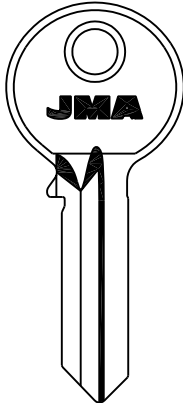
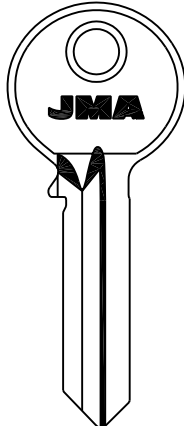
<p>PARA: T-KEY FOR:</p>  <p>TKY-1</p>	<p>TESA</p>  <p>ALP.</p> <p>TE-T12PLUS</p>	 <p>ALP.</p> <p>TE-T82</p> <p>8.8 2.8</p>	<p>UNIVERSAL</p>  <p>U-5BI</p> <p>U-5BD</p> <p>Ⓟ</p>
--	---	---	---

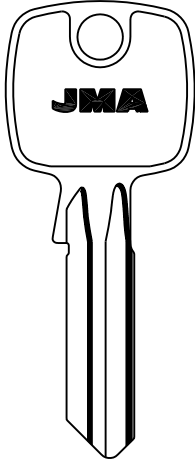
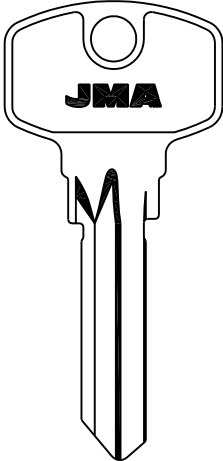
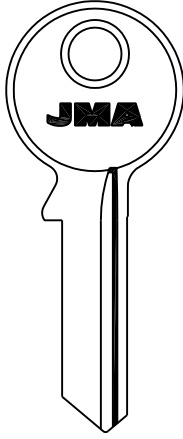
<p>PARA: UNIVERSAL FOR:</p>  <p>U-6GD</p>	<p>URBIS</p>  <p>LAT.</p> <p>URB-3D</p> <p>8.7 2.45</p> <p>Ⓟ URB-4D</p> <p>BANE SEKULIC</p>	<p>VBH</p>  <p>VB-1D</p>	 <p>VB-2D</p>
---	---	---	---

<p>PARA: WINKHAUS FOR:</p>  <p>WIN-21</p>	<p>YALE</p>  <p>YA-85D</p>	 <p>RSA</p> <p>YA-88</p> <p>ASSA ABLOY</p>	 <p>RSA</p> <p>YA-89</p> <p>ASSA ABLOY</p>
--	---	--	---

Copyright by
Alejandro Altuna S.A.
2009

JMA

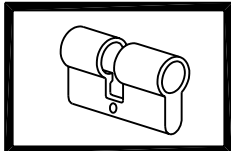

4

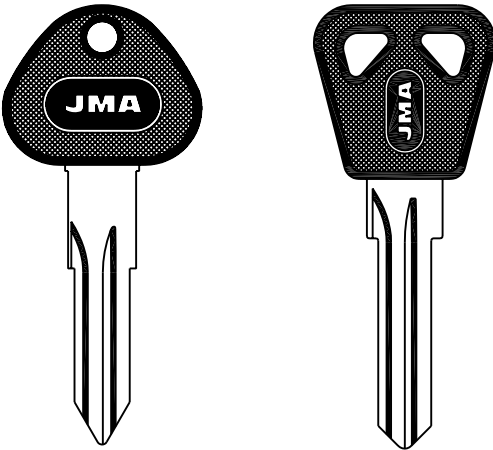
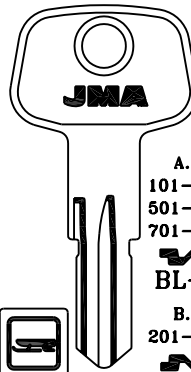
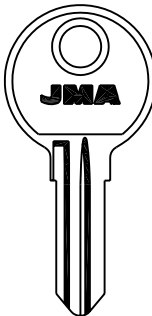
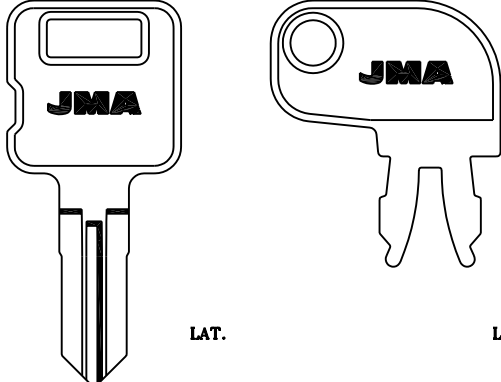
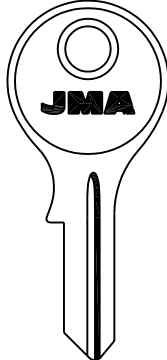
<p>PARA: ABUS FOR:</p>  <p>Z71....1-1043 Z72....1-1043</p> <p>ABU-18.P ABU-18D.P ABU-72.P</p> <p>BUFFO (B)</p>	<p>BLAU</p>  <p>A... 101-125 501-598 701-790</p> <p>BL-2</p> <p>B... 201-225</p> <p>BL-3</p> <p>A BL-4</p> <p>A 201-225 B 101-125</p> <p>BL-6 (B) BL-6D</p> <p>FORT-HK-WASO</p>	<p>BRABANTIA</p>  <p>BRA-2</p>
<p>PARA: CATERPILLAR FOR:</p>  <p>LAT. LAT.</p> <p>CAT-2 CAT-3</p>	<p>DOM</p>  <p>DOM-38D (M)</p>	

PARA-FOR:

- ABUS (D)
- BLAU (D)
- BRABANTIA (E)
- CATERPILLAR (USA)
- DOM (D)

Copyright by Alejandro Altuna S.A. 2009

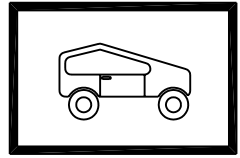

ATENCION:Concerniente a las marcas y denominaciones comerciales ver nota en indice.ATTENTION:Concerning the marks and commercial denominations see note in index. ATTENTION:Concernant les marques et denominations commerciales voir la note dans l'index.ACHTUNG:Beziehen auf die marke und handelsname sehen sie die notiz im index.

PARA-FOR:



ADPLE-11

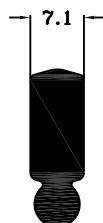
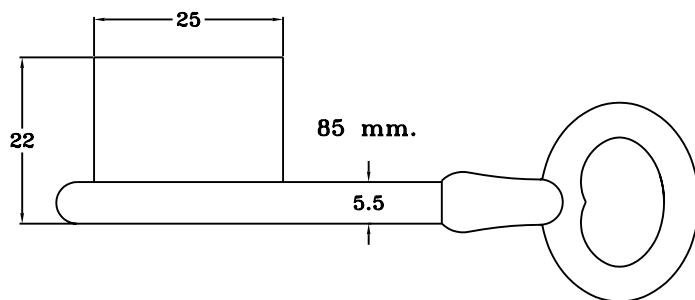

ADPLE-22

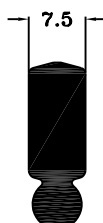
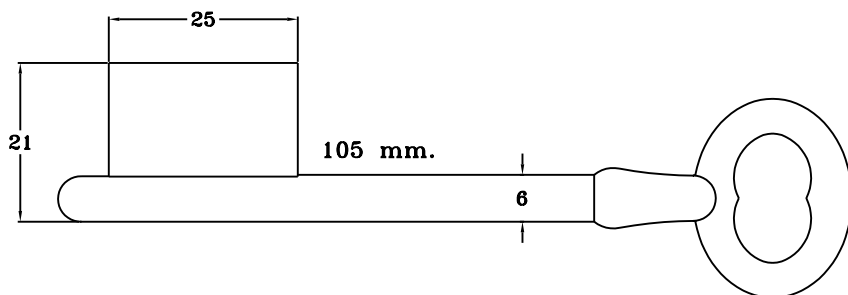

ADPLE-33

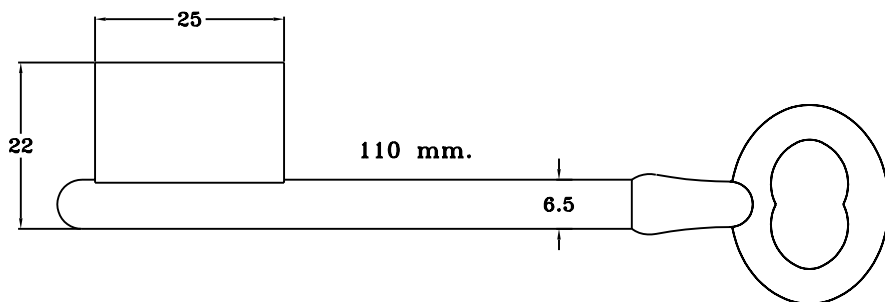

ADPLE-55

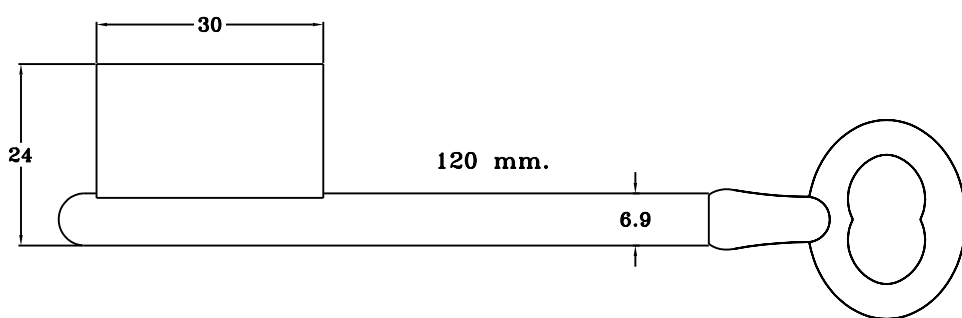





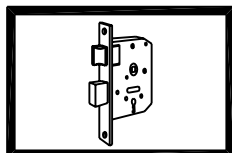

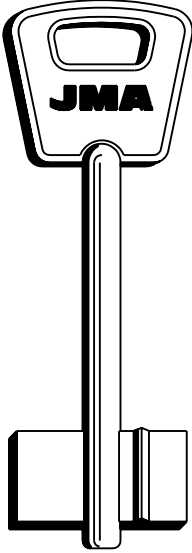

Copyright by
Alejandro Altuna S.A.
2009

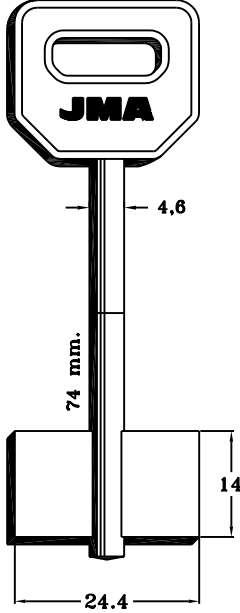
JMA

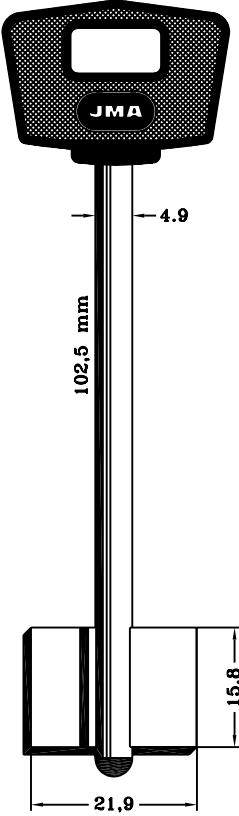

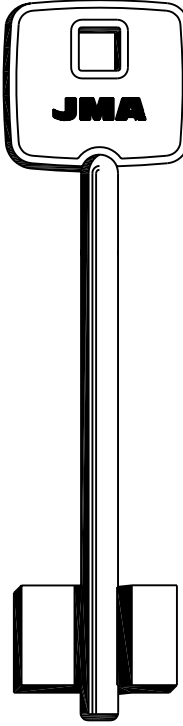
6

PARA: FOR:	BETA	FIAM	MOTTURA	POTENT
	 	 	 	 

PARA-FOR:



BETA (I)

FIAM (I)

MOTTURA (I)

POTENT (I)

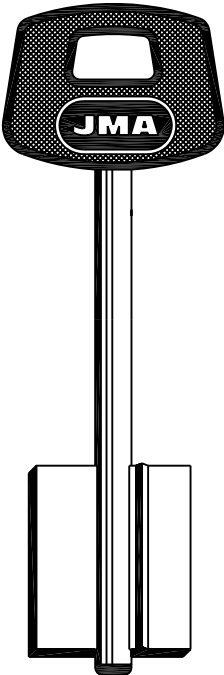
SAB (I)





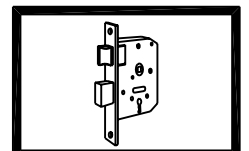

PARA: FOR:	SAB
	 

Copyright by
Alejandro Altuna S.A.
2009

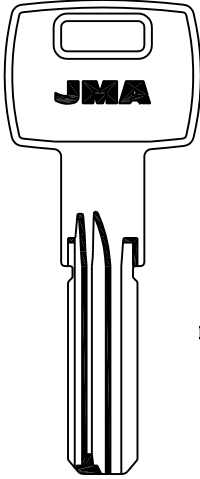
JMA

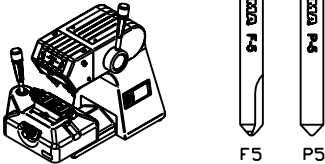
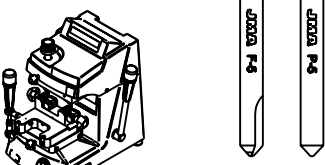
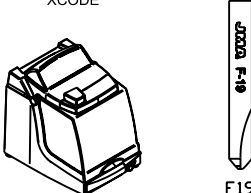
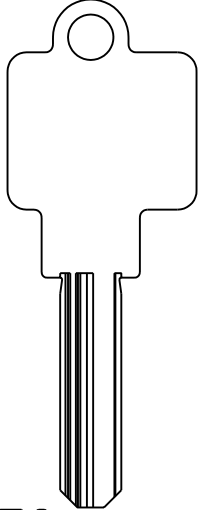
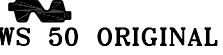
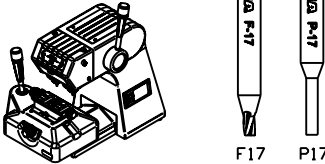
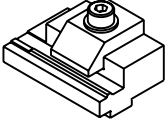
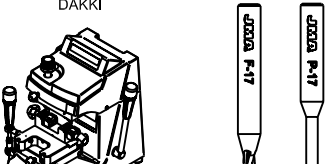
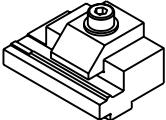
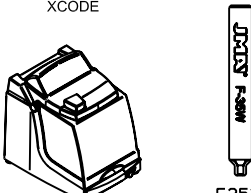
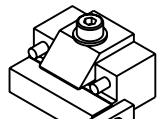
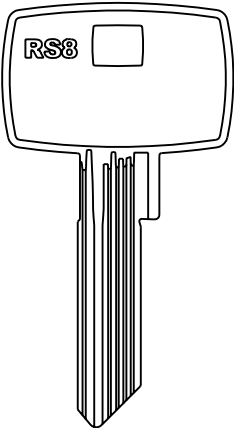

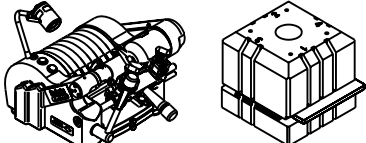
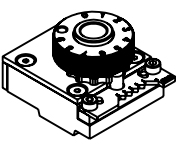
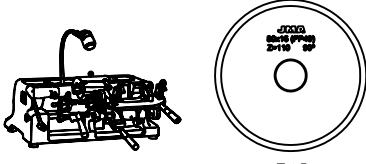
7

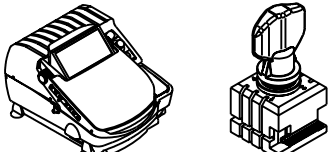
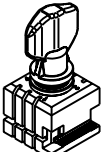
<p style="text-align: center;">BASI</p>  <p style="text-align: right;">LAT.</p>  <p style="text-align: center;">BASI-8D</p> <p style="text-align: center;">SATURN</p>		<p>DAKAR - DAKAR EXPRESS</p> 	<p>DAKKI</p> 	<p>XCODE</p> 			
<p style="text-align: center;">BKS</p>   <p style="text-align: center;">WS 50 ORIGINAL</p>		<p>DAKAR - DAKAR EXPRESS</p> 	<p>AD-BKS</p> 	<p>DAKKI</p> 	<p>AD-BKS</p> 	<p>XCODE</p> 	<p>AD-X08</p> 
<p style="text-align: center;">DOM-DORMA</p>   <p style="text-align: center;">RS8 ORIGINAL</p>	<p style="text-align: center;">PASSWORD PROTECTED DOM AUTHORIZATION</p>	<p>DAKOTA EXTRA-TITAN TITAN MASTER</p> 	<p>CODE CLAMP DO-716</p> 	<p>SARATOGA</p> 	 <p style="text-align: center;">P89</p>	<p>PROCEDURE</p> 	<p>MP2</p> 

LINCE

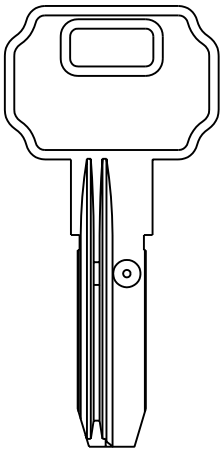

TM
C2/C3/C4 ORIGINAL

PASSWORD PROTECTED
LINCE AUTHORIZATION

XCODE

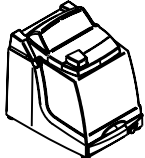

F5w

M7

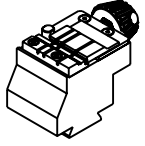

LINCE

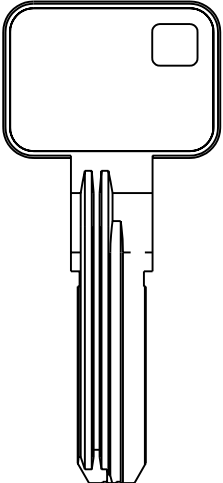

TM
C5 ORIGINAL

PASSWORD PROTECTED
LINCE AUTHORIZATION

XCODE

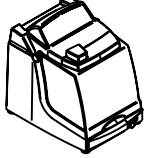

F28w

M7

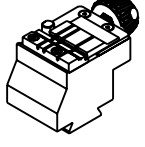

MCM

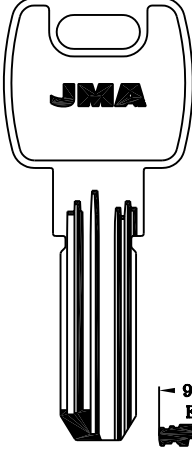

JMA

LAT.

9.7
E8
2.8

MCM-16

TM
MCM-21D

PASSWORD PROTECTED
LINCE AUTHORIZATION

DAKAR - DAKAR EXPRESS

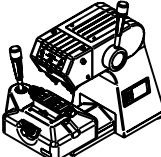

F1

P1

DAKKI

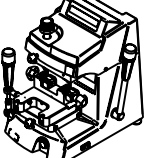

F1

P1

XCODE

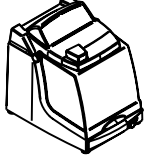

F1w

PFAFFENHAIN

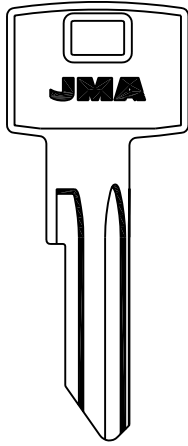

PFA-4

- EA
PFA-13D
- EB
PFA-14D
- EH
PFA-15D
- A21
PFA-10D
- EN
PFA-16D
- A22
PFA-11D
- RF
PFA-17D
- A23
PFA-12D
- RG
PFA-18D

DAKAR - DAKAR EXPRESS

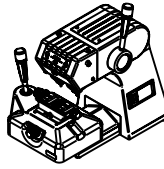

AD-PFA
Puntos laterales
Lateral dimples

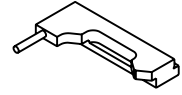

DAKKI

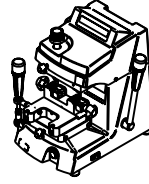

AD-PFA
Puntos laterales
Lateral dimples

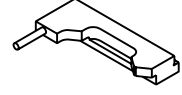

POTENT

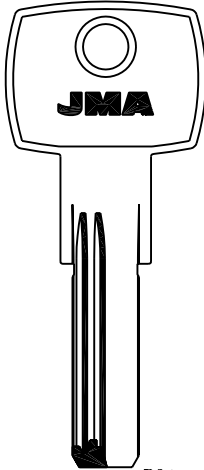

P04.....
1-2-3-4-5-6
PTN-2D

DAKAR - DAKAR EXPRESS

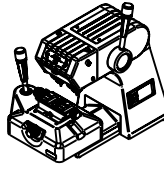

DAKKI

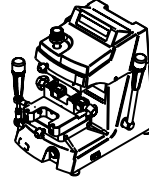

XCODE

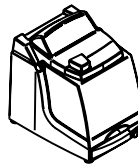

SECUREMME

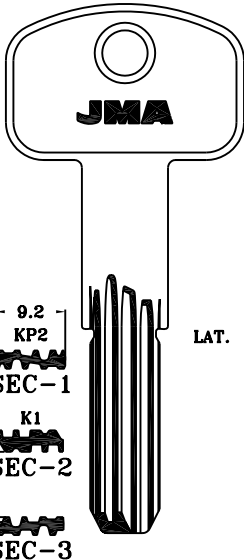

LAT.

- 9.2
KP2
2.4
SEC-1
- K1
2.85
SEC-2
- 2.37
SEC-3

DAKAR - DAKAR EXPRESS

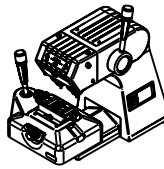

DAKKI

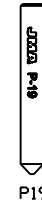
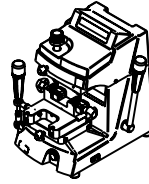

TESA

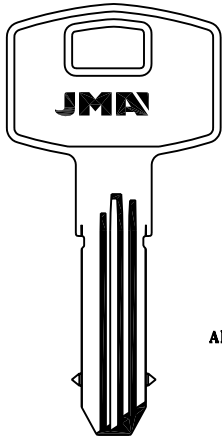

TESA
TE-T12PLUS

ALP.

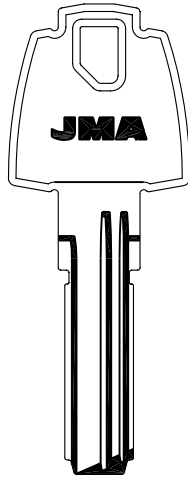

8.8 2.8
TE-T82

ALP.

DAKAR - DAKAR EXPRESS

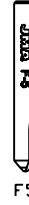
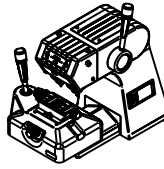

F5



P5

DAKKI

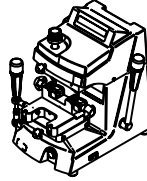

F5



P5

URBIS

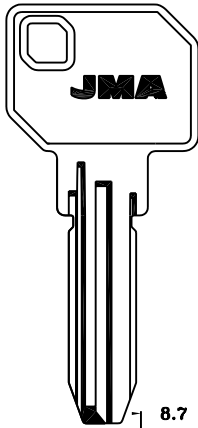

LAT.

8.7 2.45
URB-3D

URB-4D

BANE SEKULIC

DAKAR - DAKAR EXPRESS

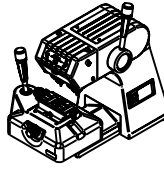

F1



P1

DAKKI

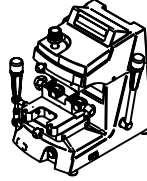

F1



P1

WINKHAUS

PASSWORD PROTECTED
WINKHAUS AUTHORIZATION

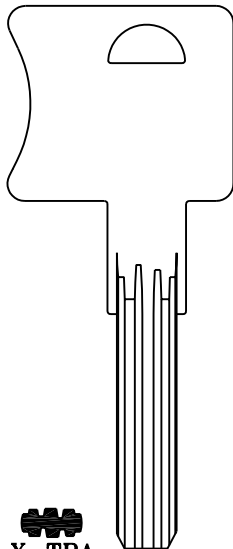

X-TRA ORIGINAL

XCODE

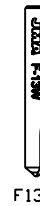
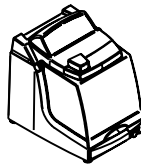

F13W

M8

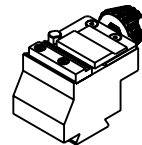

AD-X09
Puntos laterales
Lateral dimples

