



Tél. 04 73 84 84 94

CATALOGUE GENERAL N° 9

**JMA**  **2005**

Les ébauches de clés reportées sur ce catalogue sont des ébauches JMA fabriquées par Alejandro ALTUNA S.A. ou un de ses sous-traitants. Elles sont destinées aux cylindres et serrures des fabricants dont les marques sont indiquées dans ce catalogue.

Conformément aux dispositions légales en vigueur relatives à la propriété industrielle, les marques ou les dénominations commerciales citées dans ce catalogue sont la propriété exclusive des fabricants de cylindres et de serrures ainsi que des constructeurs de voitures, autres constructeurs, distributeurs et utilisateurs.

Ces marques ou dénominations commerciales sont indiquées à titre de simple information afin de connaître rapidement à quelle serrure nos ébauches sont destinées.

Ce catalogue est exclusivement réservé aux professionnels de la reproduction de clés, utilisant des ébauches JMA.

Les renseignements sur les produits de ce catalogue sont donnés à titre indicatif. Tout en gardant les caractéristiques de base, nous nous réservons le droit d'apporter, sans préavis, des modifications techniques, esthétiques ou autres, dues à l'évolution des produits en question.

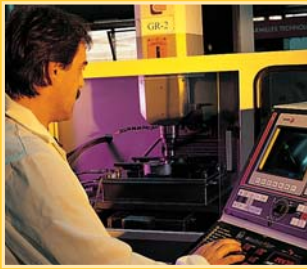

## Premier fabricant Européen de Clés Originales

### LEADER EN QUALITÉ

La qualité constitue l'un des facteurs stratégiques de JMA qui dispose du certificat ISO-9002 ainsi que de l'homologation de la part des principaux fabricants de serrures aussi bien pour le secteur de la construction que pour le secteur automobile.

Des ébauches de, cet catalogue pourront être livrées soit avec la marque et référence JMA soit avec une autre marque du groupe ALTUNA.



### LEADER EN SERVICE

La réalité d'une entreprise se démontre par sa capacité de réponse, avec le maximum de rapidité et d'efficacité, aux besoins et exigences des clients. N'importe où ils puissent se trouver.

JMA met à votre disposition trois usines productives stratégiquement réparties en Espagne, en Italie et au Mexique. En outre, grâce à son ample réseau de filiales et entreprise distributrices réparties dans le monde entier, il lui est possible d'atteindre n'importe quel client, quel que soit son emplacement.



Tél. 04 73 84 84 94

### LEADER DANS L'ENGAGEMENT ENVERS L'ENVIRONNEMENT

Premier fabricant de clés avant a obtenu le certificat ISO-14001. JMA accueille un collectif engagé pour l'écologie et l'environnement, orientant cet engagement vers l'amélioration des coûts et vers la compétitivité à long terme.

Imprimé sur papier 100% recyclé



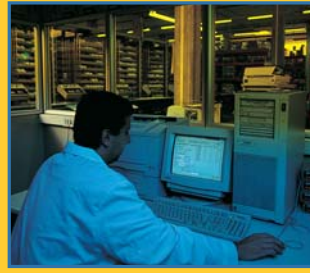

## LEADER EN PRODUCTIVITÉ

Un produit entièrement personnalisé, répondant aux besoins concrets de chaque client, où chaque procédé de travail a été étudié pour optimiser au maximum le produit final, peut seulement être obtenu par une entreprise leader. C'est pour cette raison que JMA est l'entreprise Européenne leader en productivité.

En outre, grâce à son haut degré d'automatisation et à une efficace gestion de ses processus de planification et de stockage, JMA est capable de produire plus de 1.000.000 de clés par jour, avec une garantie de qualité absolue.

Sa large gamme de clés, avec plus de 20.000 références différentes, lui permet de se trouver à l'avant-garde du secteur de fabrication de clés.

**ALTUNA  
GROUP**

11 sociedades en 11 países: 350 personas y más de 320 millones de llaves al año. Con ventas en los 5 continentes.

11 sozietate 11 herrialdetan: 350 pertsona lanean eta 320 milioi giltza baino gehiago urtean. 5 kontinenteetan saltzen ditu bere produktuak.

11 companies in 11 countries: 350 people and more than 320 million keys a year. With sales on 5 continents.

11 sociétés dans 11 pays: 350 personnes et plus de 320 millions de clefs par an. Ventes dans les 5 continents.

11 Unternehmen in 11 Ländern: 350 Mitarbeiter und über 320 Millionen Schlüssel pro Jahr. Mit Verkauf in allen fünf Kontinenten.

11 società in 11 paesi: 350 addetti e oltre 320 milioni di chiavi all'anno. Con vendite nei 5 continenti.

sede central  
egoitza nagusia  
central seat

siège central  
zentraler Sitz  
sede centrale

**ESPAÑA**

fabricación  
produkzioa  
manufacture

fabrication  
herstellung  
produzione

**ESPAÑA**

**ITALIA**

**MÉXICO**

**ARGENTINA**

comercialización, tecnología y logística  
merkatizatzea, teknologia eta logistika  
marketing, technology and logistics

commercialisation, technologie et logistique  
vermarktung, technologie und logistik  
comercialización, tecnología y logística

**INGLATERRA**

**FRANCIA**

**POLONIA**

**USA**





**ALEMANIA**

**PORTUGAL**

**ARGENTINA**

• sommaires •

A1  
A27

- 
- 
- 
-  Index generale
- 
- 

A28  
A48

- 
- 
- 
-  Index marque
- 
- 

1  
122

- 
- 
- 
-  Clés pour cylindres
- 
- 







125  
199

- 
- 
- 
-  Clés pour véhicules
- 
- 

203  
204

- 
- 
- 
-  Clés de bouche d'eau
- 
- 

207  
215

- 
- 
- 
-  Clés cruciformes
- 
- 

219  
238

- 
- 
- 
-  Clés à gorges en acier doux
- 
- 

241  
294

- 
- 
- 
-  Clés à gorges en laiton
- 
- 

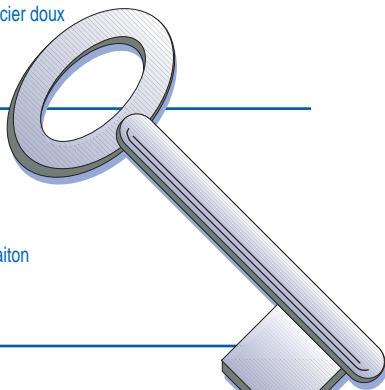
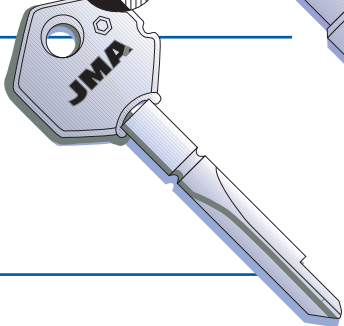
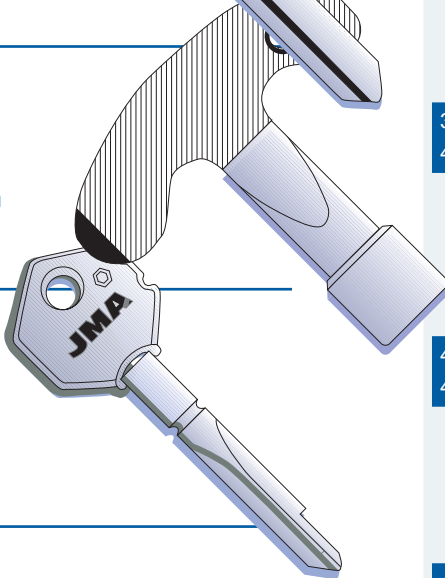
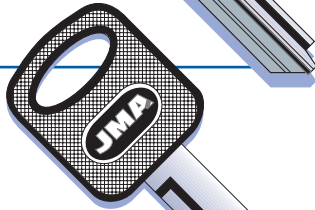
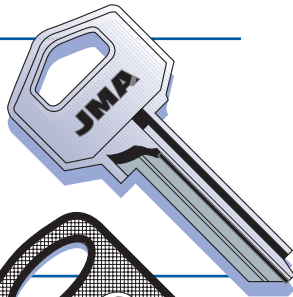

297

- 
- 
- 
-  Clés à gorges en zamak
- 
- 







301  
304

- 
- 
- 
-  Clés pour meubles en laiton
- 
- 

307

- 
- 
- 
-  Clés pour meubles en zamak
- 
- 

311

- 
- 
- 
-  Clés pour ascenseurs et boites a lettres
- 
- 

315  
409

- 
- 
- 
-  Voiture-Camionnette
- 
- 







413  
423

- 
- 
- 
-  Camion
- 
- 

427  
465

- 
- 
- 
-  Motocyclette
- 
- 

469  
470

- 
- 
- 
-  Alarme-Avion-Bicyclette-Caravane-Bouchon reservoir-Moteur de bateau-Porte ski-Traktor-Machine por déplacement-De terre-Clark-Tondeuse
- 
- 

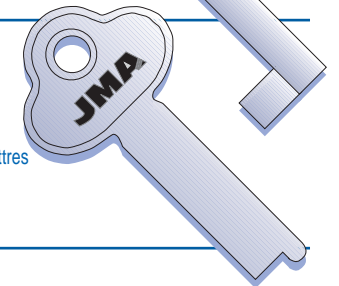
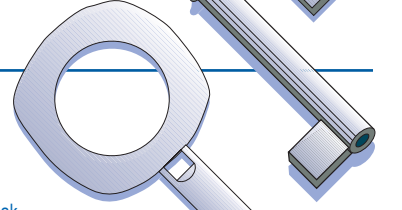
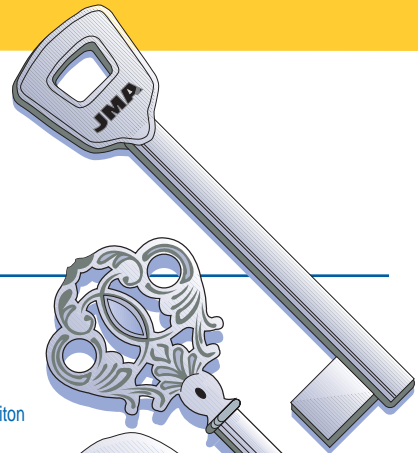

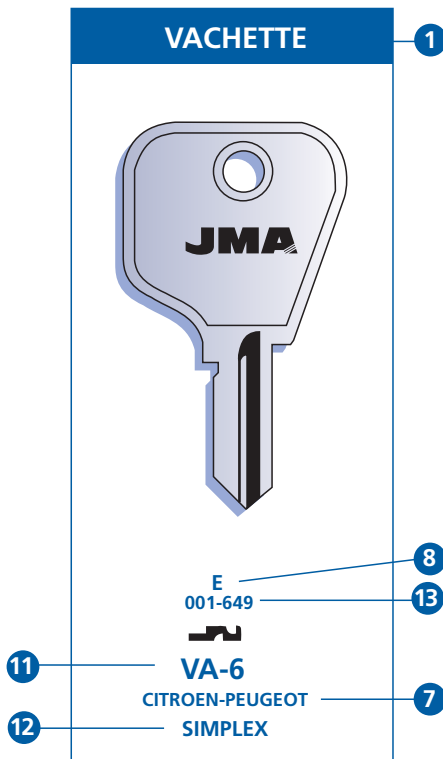
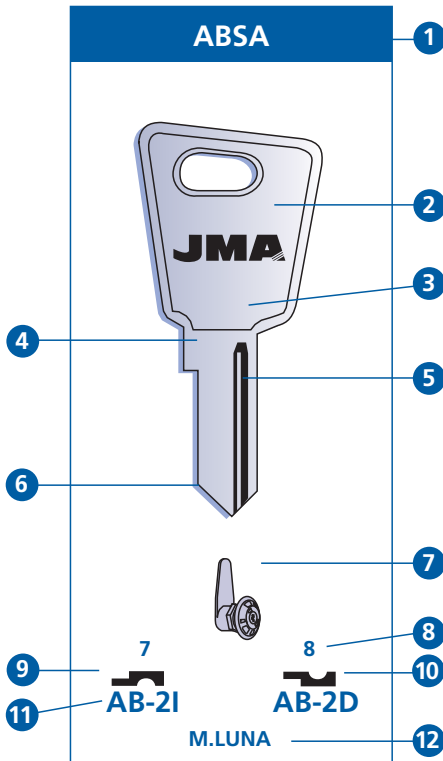

15 ABSA (E)  
FROSER  
M.LUNA

1	MARCA PRINCIPAL Marka nagusia Main brand	Marque principale Hauptprägung Marca principale
2	CABEZA Burua Head	Tete Kopf Testa
3	CUELLO Lepoa Neck	Cou Hals Collo
4	TOPE Topea Shoulder	Arret Anschlag Fermo
5	PALETON Belarria Blade	Canon Schaft Canna
6	PUNTA Punta Tip	Pointe Spitze Punta
7	UTILIZACIÓN Erabilera Use	Utilisation Verwendung Utilizzo
8	NOMENCLATURA DEL PERFIL ORIGINAL Jatorrizko profilaren izendegia Original profile	Profil original Original-profil Profilo originale
9	PERFIL IZQUIERDO Ezkerreko profila Left profile	Profil gauche Links profil Profilo sinistro
10	PERFIL DERECHO Eskuineko profila Right profile	Profil droit Rechts profil Profilo destro
11	REFERENCIA Erreferentzia Reference	Reference Bezeichnung Referenza
12	MARCAS SECUNDARIAS Bigarren mailako markak Secondary brand	Marque secondaire 2. Prägung Marca secundaria
13	SERIES Serieak Series	Code Serie Serie
14	MARCA PRINCIPAL Marka nagusia eta jatorrizkoa Main brand and nationality	Marque principale et nationalité Auptprägung und nationalität Marca principale e nationalita
15	MARCAS SECUNDARIAS DE LA PRINCIPAL (ABSA) Marka nagusiaren bigarren mailako markak (ABSA) Secondary brands of the main one (ABSA)	Marques secondaires de la principale (ABSA) 2. Prägung für Hauptprägung (ABSA) Marca secundaria de la principale (ABSA)

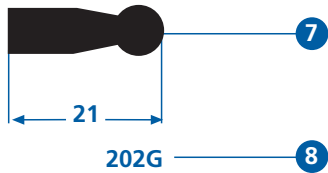
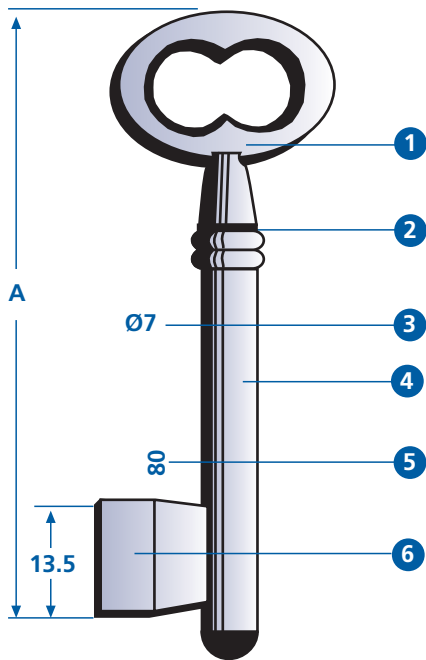

202G — 8



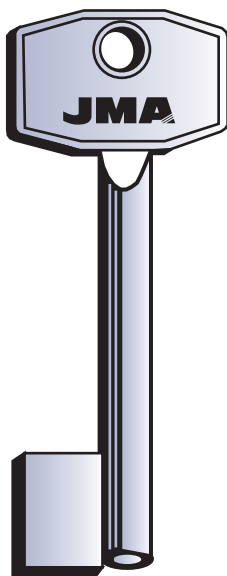





ORENGO — 9



OR-1G — 8

1	CABEZA Burua Head	Tete Kopf Testa
2	CUELLO Lepoa Neck	Cou Hals Collo
3	DIAMETRO DE LA CAÑA Ziriaren diametroa Shank diameter	Diametre du canon Halm-Durchmesser Diametro della canna
4	CAÑA Ziria Shank	Canon Halm Canna
5	LONGITUD A A Luzera Length A	Longueur A Länge A Longitudine A
6	PALETON Belarria Bit	Panneton Bart Mappa
7	PERFIL MACHO Profil Arra Pin bit profile	Profil male Chubbschlüssel profil Profilo maschio
8	REFERENCIA Erreferentzia Reference	Reference Bezeichnung Referenza/home
9	MARCA ORIGINAL Jatorrizko marka Original brand	Marque originale Original-Prägung Marca originale
10	PERFIL HEMBRA Profil emea Pipe bit profile	Profil femelle Rohr chubbschlüssel profil Profilo femmina

## • signes conventionels •

ALP.	<p>LLAVE FABRICADA EN ALPACA Alpakaz egindako giltza Key available in nickel silver</p>	<p>Cle fabrique en maillechort Schlüssel auch in Neusilber Chiave fabbricata in alpaca</p>
LAT.	<p>LLAVE DISPONIBLE TAMBIÉN EN LATÓN Giltza, letoizkoa ere eskuragarria Key also available in brass</p>	<p>Cle aussi disponible en laiton Schlüssel auch in messing lieferbar Chiave disponibile anche in ottone</p>
COL.	<p>LLAVE DISPONIBLE TAMBIÉN CON CABEZA DE PLÁSTICO EN COLORES Giltza hau koloretako plastikozko buruarekin ere eskuragarria Key also available with coloured plastic head</p>	<p>Cle aussi disponible avec tete plastifiée en couleurs Schlüssel auch mit Farbigem Plastik-kopf lieferbar Chiave disponibile anche con la testa di plastica colorata</p>
ALU.	<p>LLAVE DISPONIBLE TAMBIÉN EN ALUMINIO Giltza, aluminioan ere eskuragarria Key also available in aluminium</p>	<p>Cle aussi disponible en aluminium Schlüssel auch in aluminium lieferbar Chiave disponibile anche in alluminio</p>
ZAM.	<p>LLAVE FABRICADA SOLAMENTE EN ZAMAK Zamakez soilik egindako giltza Key only available in zamak</p>	<p>Cle aussi disponible en zamak Schlüssel nur aus zamak lieferbar Chiave fabbricato solo in zama</p>
 35	<p>LLAVE DE UTILIZACION EN CANDADOS Giltzarrapoetan erabiltzeko giltzak Key for padlocks</p>	<p>Cle pour cadenas Schlüssel für hangschlosser Chiave per lucchetto</p>
	<p>LLAVE DE UTILIZACIÓN EN CERRADURAS AUXILIAR Sarraila osagarrietan erabiltzeko giltzak Key for cam locks</p>	<p>Cle pour petite serrurie Schlüssel für Habelschlosser Chiave per serratura ausiliarie</p>
	<p>LLAVES PARA MOTOCICLETAS Motozikleta giltzak Key for motorcycles</p>	<p>Cle pour motocyclettes Schlüssel für Motorräder Chiave per motocicletta</p>
	<p>LLAVE PARA TAPÓN DE GASOLINA Gasolina-tapoiarako giltza Key for fuel cap</p>	<p>Cle pour bouchon d'essence Schlüssel für Tankdeckel Chiave per tappi benzina</p>
	<p>LLAVE PARA CAMIÓN Kamioiko giltza Key for lorries</p>	<p>Cle pour camion Schlüssel für Lastwagen Chiave per camion</p>
	<p>ALARMA Alarma Alarm</p>	<p>Alarme Alarm Alarme</p>
	<p>LLAVES GORJA CON ACABADO EN COLOR NATURAL Gorja giltzak berezko kolorezko akaberarekin Bit key blank with natural colour finishing</p>	<p>Cle a gorges avec finition en couleur naturel Chubbschlüssel in naturfarben ausführung Chiave a mappa in colore naturale</p>
	<p>LLAVES GORJA CON ACABADO EN NEGRO ANTIGUO Gorja giltza, beltz zaharkitu akaberarekin Bit key blank with old black finishing</p>	<p>Cle a gorges avec finition en vieux noir Chubbschlüssel in Alt-schwarzer ausführung Chiave a mappa in colore nero antico</p>



Calendario  
Egutegia  
Calendar  
Calendrier  
Kalender  
Calendario



Contacto auto  
Autoko kontaktua  
Engine ignition  
Contact auto  
Anlasskontakt auto  
Contatto machina



Puerta  
Atea  
Door lock  
Portière  
Türe  
Portiera



Maletero/Puerta trasera  
Maletategia/Atzeko atea  
Boot/Hatchback  
Coffre/Portière postérieure  
Kofferraum/Hecktür  
Bagagliaio/Portiera posteriore



Tapón de gasolina  
Gasolina-tapoa  
Petrol cap  
Bouchon réservoir  
Benzintankverschluss  
Tappo benzina

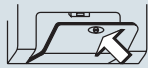

Guantera  
Eskularru-kutxa  
Drawer  
Tiroir  
Schublade  
Cassetto



Contacto moto  
Moto-kontaktua  
Motorbike ignition  
Contact moto  
Anlasskontakt motorrad  
Contatto moto



Bloqueo moto  
Moto-blokeoa  
Motorbike blocking  
Bloquage moto  
Blockierung motorrad  
Blocco moto



Sillin  
Zela  
Cycle seat  
Selle  
Sattel  
Sella



Casco  
Kaskoa  
Helmet  
Casque  
Helm  
Casco



Automovil / camioneta  
Automobila / kamioneta  
Car / Pick-up trucks  
Voiture / Camionnette  
Auto / Kleintransporte  
Auto / Camioncino

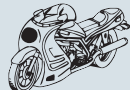

Motocicleta  
Motozikleta  
Motorcycle  
Motocyclette  
Motorrad  
Motocicletta



Camión  
Kamioia  
Trucks  
Camion  
Lkw  
Camion



Avión  
Hegazkina  
Airplain  
Avion  
Flugzeuge  
Aerei



Caravana  
Karabana  
Caravans  
Caravane  
Wohnwagen  
Caravan



Motor marino  
Itsas motorra  
Boat engines  
Moteur de bateau  
Schiffsmotoren  
Motori marini



Bicideta  
Bizikleta  
Bicycle  
Bicyclette  
Fahrräder  
Biciclette



Alarma  
Alarma  
Alarm  
Alarme  
Alarm  
Alarme



Portaesquis  
Eski-euskarria  
Ski holder  
Porte ski  
Skiträger  
Portasci



Tractor  
Traktorea  
Tractor  
Traktor  
Landmaschinen  
Trattori



Escavadora  
Hondeatzailea  
Earth moving machin  
Machine déplacement de terre  
Baumaschinen  
Machine movimento terra



Carretilla elevadora  
Orga jasotzailea  
Froklift  
Clark  
Gabelstapler  
Muletti



Corta cesped  
Belarra mozteko makina  
Lawn-mower  
Tondeuse  
Rasenmäher  
Rasaerba



Alarma - llave  
Alarma - giltza  
Alarm - key  
Alarme - cief  
Alarm - schlüssel  
Allarme - chiave

## NACIONALIDAD

### NAZIONALITATEA - NATIONALITY - NATIONALITAT - NACIONALIDAD - NATIONALITE

PAIS	SIGNO	PAIS	SIGNO	PAIS	SIGNO
AUSTRIA	A	HONG KONG	HK	TAIWAN	RC
AUSTRALIA	AUS	CROATIA	HR	CHILE	RCH
BELGIUM	B	ITALY	I	CHEKIA	RCZ
BRAZIL	BR	ISRAEL	IL	RUMANIA	RU
CANADA	CDN	INDIA	IND	SWEDEN	S
SWITZERLAND	CH	EIRE	IRL	FINLAND	SF
GERMANY	D	JAPAN	J	SLOVENIA	SLO
DENMARK	DK	KOREA	K	RUSIA	RUS
ALGERIA	DZ	KUWAIT	KW	CHINA	TJ
SPAIN	E	MEXICO	MEX	TUNISIA	TN
ESLOVAKIA	ES	NORWAY	N	UNITED STATES OF AMERICA	USA
EGYPT	ET	THE NETHERLANDS	NL	YUGOSLAVIA	YU
FRANCE	F	PORTUGAL	P	VENEZUELA	YV
GREAT BRITAIN	GB	PERU	PE	ZAMBIA	Z
GREECE	GR	POLAND	PL		
HUNGARY	H	ARGENTINA	RA		

# ALUMINIO

color



ALU.

# fashion



FSH.

# Color matic



MTIC.

# INDICE GENERAL

AURKIBIDE OROKORRA • GENERAL INDEX • INDEX GENERALE • GESAMTVERZEICHNIS • INDICE GENERALE

## LLAVES PARA CERRADURAS A CILINDRO Y VEHICULOS

SARRAILA ZILINDRIKO ETA IBILGAILUENTZAKO GILTZAK • KEYS FOR CYLINDERS AND VEHICLES • CLES CYLINDERS ET VEHICLES •

SCHLÜSSEL FÜR ZYLINDER UND AUTO SCHLOSSER • CHIAVI PER SERRATURE A CILINDRO E PER VEICOLI

TEXTO	PAG.	PAG.	TEXTO	PAG.	PAG.	TEXTO	PAG.	PAG.
5-L	104		ABC-3D	1		ABU-27D	4	
6-C	113		ABC-5D	1		ABU-28	4	
6-L	113		ABC-5I	1		ABU-29P	5	
7-S	92		ABC-6	1		ABU-30	5	
8M-1D	80		ABC-7	1		ABU-30D	5	
15-D	183		ABL-1	2		ABU-32D	5	
15-I	183		ABL-2	2		ABU-34	5	
16-D	183		ABL-3	2		ABU-35P	5	
16-I	183		ABL-4	2		ABU-36P	5	
26-M	86		ABL-5	2		ABU-37D	3	
28-D	126		ABU- 1	3		ABU-38D	5	
35-D	113		ABU- 1D	3		ABU-39P	5	
35-I	113		ABU- 2D	3		ABU-40	5	
38-D	113		ABU- 2I	3		ABU-41	5	
38-I	113		ABU- 3	3		ABU-41D	5	
41-4/4	169		ABU- 4D	3		ABU-42	5	
45-1	1		ABU- 4I	3		ABU-42D	5	
45-1D	1		ABU- 5D	3		ABU-43D	3	
45-2	1		ABU- 6D	3		ABU-44	3	
45-2D	1		ABU- 6I	3		ABU-45	5	
48-D	148		ABU- 7D	3		ABU-46	3	
48-I	148		ABU- 8D	3		ABU-46D	3	
303-1	1		ABU- 8I	3		ABU-47	3	
303-1D	1		ABU- 9D	3		ABU-48	4	
333-1D	1		ABU- 9I	3		ABU-49	3	
333-2D	1		ABU-10D	3		ABU-50	5	
			ABU-10I	3		ABU-51D	5	
<b>A</b>			ABU-11	3		ABU-52D	3	
AB- 1D	2	125	ABU-11D	3		ABU-53	3	
AB- 1I	2	125	ABU-12D	3		ABU-54	6	
AB- 1T	2		ABU-12I	3		ABU-54D	6	
AB- 2D	2	125	ABU-13	3		ABU-55	3	
AB- 2I	2	125	ABU-13D	3		ABU-55D	3	
AB- 2T	2		ABU-14	3		ABU-60	5	
AB- 3I	2		ABU-15	3		ABU-61	6	
AB- 3T	2		ABU-15D	3		ADS-1D	6	
AB- 4D	125		ABU-16	4		AEP-1D	6	
AB- 4T	2		ABU-17	4		AEP-2D	6	
AB- 5D	2	125	ABU-17D	4		AF- 1D	183	
AB- 5I	2	125	ABU-18P	4	125	AF- 1I	183	
AB- 6D	2	125	ABU-19D	4	125	AF- 2D	183	
AB- 6I	2	125	ABU-19DP	4	125	AF- 2I	183	
AB- 7I	125		ABU-19P	4	125	AF- 3D	183	
AB- 8D	2	125	ABU-20	3		AF- 3I	183	
AB- 8I	2	125	ABU-21	3		AF- 4D	183	
AB- 9D	3		ABU-22D	4		AF- 4I	183	
AB-10I	125		ABU-23D	4		AF- 5D	183	
AB-11	3		ABU-24D	4		AF- 5I	183	
ABC-1	1		ABU-25D	4		AF- 6D	183	
ABC-2	1		ABU-26D	4		AF- 6I	183	
			ABU-27	4		AF- 7D	185	

TEXTO	PAG.	PAG.	TEXTO	PAG.	PAG.	TEXTO	PAG.	PAG.
AF- 7I	185		AGA-29	7		ARR-8	12	
AF- 7IP	185		AGA-38	7		ARS-1D	12	
AF- 7IP1	185		AGA-39	8		AS - 1D	126	
AF- 8D	185		AGB-1	8		AS - 1I	126	
AF- 8DP	185		AGB-1D	8		AS - 2D	126	
AF- 8I	185		AGB-2	8		AS - 2I	126	
AF- 8IP	185		AGB-3	8		AS - 3D	12	
AF- 9D	185		AGD-1	8		AS - 3I	12	
AF- 9DP	185		AGE-1I	8		AS - 4D	12	
AF- 9I	185		AGE-2D	8		AS - 5D	12	
AF- 9IP	185		AGU-1D	8		AS - 6D	12	
AF-10	183		AHR-2	8		AS - 7D	12	
AF-11	183		AHR-3	8		AS - 8D	12	
AF-12	183		AIZ-1	9		AS - 9D	12	
AF-13	141		AIZ-2D	9		AS -10D	12	
AF-13P	141		AKS-1	125		AS -11D	12	
AF-14	142		AL-1I	9		AS -12D	12	
AF-14P	142		AL-2	9		AS -13D	12	
AF-19	183		AL-3	9		AS -14D	12	
AF-19P	183		ALC-1D	9		AS -15D	12	
AF-21	183		ALE-1	9		AS -16D	12	
AF-21P	183		ALE-1D	9		AS -17D	126	
AG- 1D	8		ALI-1	29		AS -18D	12	
AG- 1I	8		ALP-1D	9	125	AS -19D	126	
AG- 3D	8		ALP-1I	9	125	AS -20D	13	
AG- 3I	8		ALP-2	9	125	AS -21	126	
AG- 4D	8		ALP-2D	9	125	AS -21D	126	
AG- 4I	8		ALP-3	9		AS -21DP	126	
AG- 5D	8		ALP-4D	9		AS -21P	126	
AG- 5I	8		ALP-5D	9		AS -22	13	
AG- 6D	8		AMB-1	1		AS -23D	13	
AG- 6I	8		AMB-1D	1		AS -24	126	
AG- 8D	8		AMG- 1	9		AS -24D	126	
AG- 8I	8		AMG- 2D	10		AS -A5	13	
AG- 9D	8		AMG- 3D	10		AS -A7	13	
AG- 9I	8		AMG- 4D	10		AS -AK5	13	
AG-10D	8		AMG- 5D	10		AS -AK7	14	
AG-10I	8		AMG- 8D	10		AS -AL5	13	
AG-11	8		AMG- 9D	10		AS -AL7	14	
AG-11D	8		AMG-10D	10		AS -AM5	13	
AGA- 1I	6		AMM-1	126		AS -AM7	14	
AGA- 1T	6		AMM-2	126		AS -B5	13	
AGA- 2T	6		ANA-1	11		AS -B7	13	
AGA- 3I	6		ANA-1D	11		AS -BK5	13	
AGA- 4D	6		ANC-1D	10		AS -BK7	14	
AGA- 4I	6		ANC-2	10		AS -BL7	14	
AGA- 5D	6		ANK- 1	10		AS -BM7	14	
AGA- 5I	6		ANK- 2	10		AS -D7	14	
AGA- 6D	6		ANK- 3	10		AS -DD7	14	
AGA- 6I	6		ANK- 4	11		AS -DK5	13	
AGA- 7	7		ANK- 6	11		AS -DK7	14	
AGA- 8D	7		ANK-17	11		AS -DL5	13	
AGA- 9I	7		ANK-47D	11		AS -DL7	14	
AGA-10	7		AP-1D	11		AS -DM5	13	
AGA-11	7		AP-2D	11		AS -DM7	14	
AGA-12	7		AP-3D	11		AS -E5	13	
AGA-13I	7		AR-4DP	12		AS -E7	13	
AGA-14D	7		AR-4IP	12		AS -EK5	13	
AGA-15	7		ARC-17DP	11		AS -EK7	14	
AGA-16I	7		ARC-17P	11		AS -EL5	13	
AGA-18D	6		ARE-1D	11		AS -EL7	14	
AGA-18I	6		ARFE-1D	11		AS -EM5	13	
AGA-19D	6		ARFE-1I	11		AS -EM7	14	
AGA-19I	6		ARFE-2	11		AS -F5	13	
AGA-20	7		ARFE-3D	12		AS -F7	13	
AGA-22	7		ARO-1D	12		AS -FK5	13	
AGA-23	7		ARR-1	12		AS -FK7	14	
AGA-24D	7		ARR-2	12		AS -FL7	14	
AGA-24I	7		ARR-3	12		AS -FM7	14	

TEXTO	PAG.	PAG.	TEXTO	PAG.	PAG.	TEXTO	PAG.	PAG.
AS -G5	13		AS -UU7	14		BAG-1	16	
AS -G7	13		AS -V5	13		BAI-1D	17	
AS -GG7	14		AS -V7	14		BAI-6	21	
AS -GK5	13		AS -VV7	14		BAI-7	21	
AS -GK7	14		AS -W5	13		BAN-1D	17	
AS -GL5	13		AS -W7	14		BAN-1I	17	
AS -GL7	14		AS -WWW7	14		BAN-2D	17	
AS -GM5	13		AS -X7	14		BAN-3D	17	
AS -GM7	14		AS -XX7	14		BAS-1D	126	
AS -H7	14		AS -Z7	14		BAS-1I	126	
AS -HH7	14		ASH-2	12		BAS-2D	127	
AS -K7	13		ASI-1	12		BAS-2I	127	
AS -KA7	14		ATA-1	9		BAS-3	127	
AS -KD7	14		ATA-1D	9		BAS-4	17	127
AS -KE5	14		AU -1	148		BAST-1I	17	
AS -KE7	14		AU -AH	148		BAST-2D	17	
AS -KF7	14		AU -AHP	148		BAST-3D	18	
AS -KG7	14		AU -AHP1	148		BATU-1I	18	
AS -KK7	14		AU -AN	148	156	BCZ-1	17	
AS -L7	13		AU -ANP	148	156	BCZ-2	17	
AS -LA7	14		AU -C	148		BD-1	16	
AS -LD7	14		AU -HV	149		BE-1	18	
AS -LE7	14		AU -HVP	149		BE-4D	18	
AS -LF7	14		AU -HVP1	149		BE-4I	18	
AS -LG7	14		AU -W	149		BE-5D	18	
AS -M5	13		AUM-2D	14		BE-5I	18	
AS -M7	13		AV-1	14		BES-1D	18	
AS -MA7	14		AV-1D	14		BEY-1D	18	
AS -MD7	14		AV-2D	14		BH-1	127	
AS -ME5	14		AX-1	126		BH-1P	127	
AS -ME7	14		AX-1D	126		BH-2	127	
AS -MF7	14		AX-1DP	126		BH-3	127	
AS -MG7	14		AX-1P	126		BH-4	127	
AS -MM5	13		AZ- 1D	14		BH-5	127	
AS -MM7	14		AZ- 1I	14		BH-6	128	
AS -N5	13		AZ- 2D	15		BI-1D	18	
AS -N7	13		AZ- 2I	15		BI-2	18	
AS -NN5	13		AZ- 3D	15		BI-3D	18	
AS -NN7	14		AZ- 3I	15		BIE-1	18	
AS -P5	13		AZ- 4	15		BIF-1	18	101
AS -P7	13		AZ- 6	15		BIL-1T	18	
AS -PA7	14		AZ- 7	15		BK-1D	19	
AS -PB7	14		AZ- 8D	15		BK-1I	19	
AS -PF7	14		AZ- 9	15		BK-2D	19	
AS -PG7	14		AZ- 9D	15		BK-3D	19	
AS -PH7	14		AZ-10	15		BK-4	19	
AS -PN7	14		AZ-12	15		BK-4D	19	
AS -PP7	14		AZ-14	15		BK-5D	19	
AS -PR7	14		AZ-17	15		BK-5I	19	
AS -PT7	14		AZ-17D	15		BK-6D	19	
AS -R7	13		AZ-18	15		BK-6I	19	
AS -RA7	13		AZ-18D	15		BK-7D	19	
AS -RB7	13		AZKO-1I	16		BK-8D	19	
AS -RC7	13					BK-9	19	
AS -RD7	13		<b>B</b>			BKY-1	19	
AS -RE7	13					BKY-2	20	
AS -RF7	13		BAB- 1I	16		BL-1D	127	
AS -RG7	13		BAB- 2I	16		BL-1I	127	
AS -RH7	13		BAB- 3	16		BL-2	127	
AS -RK7	13		BAB- 3D	16		BL-3	127	
AS -RN7	13		BAB- 4D	16		BL-4	127	
AS -RR7	14		BAB- 5	16		BL-4D	127	
AS -S7	13		BAB- 5D	16		BL-5	127	
AS -SS7	14		BAB- 6	16		BL-5D	127	
AS -T5	13		BAB- 7	16		BLT-1	16	
AS -T7	14		BAB- 8D	16		BM-1P	149	
AS -TT7	14		BAB- 9D	16		BM-2	149	
AS -U5	13		BAB-11	16		BM-2P	149	
AS -U7	14		BAB-12D	16		BM-3	149	

TEXTO	PAG.	PAG.	TEXTO	PAG.	PAG.	TEXTO	PAG.	PAG.
BM-3P	149		BS-9D	128		CE- 1D	25	
BM-4	149		BSh-1	17		CE- 1I	25	
BM-5P	149		BSh-1D	17		CE- 2D	25	
BM-B	149		BSh-2	17		CE- 2I	25	
BM-HB	150		BSS-1D	21		CE- 3D	25	
BM-HBP	150		BSS-2	21		CE- 3I	25	
BM-HBP1	150		BSS-2D	21		CE- 4D	25	
BM-NB	150		BTV-1D	21		CE- 5	26	
BM-NBP	150		BTV-1I	21		CE- 5D	26	
BM-W	150		BTV-2D	21		CE- 6D	26	
BOD-1	19		BTV-2I	21		CE- 6I	26	
BOM-1	19		BU-1D	23		CE- 7D	26	
BOM-1D	19		BU-1I	23		CE- 7I	26	
BOM-2	19	127	BUR- 1D	21		CE- 8D	26	
BOM-2D	19	127	BUR- 1I	21		CE- 9D	26	
BRA-1	76		BUR- 2D	21		CE- 10D	26	
BRAS-1	20		BUR- 2I	21		CE- 11D	26	
BRI- 1D	20		BUR- 3D	21		CE- 12D	26	
BRI- 1I	20		BUR- 4	22		CE- 13D	26	
BRI- 2D	20		BUR- 4D	22		CE- 14D	26	
BRI- 2I	20		BUR- 5	22		CE- 15D	26	
BRI- 3D	20		BUR- 5D	22		CE- 16D	26	
BRI- 3I	20		BUR- 6	22	128	CE- 17D	26	
BRI- 4D	20		BUR- 7	22		CE- 18D	26	
BRI- 4I	20		BUR- 8D	22		CE- 19D	26	
BRI- 6D	20		BUR- 9D	22		CE- 20D	26	
BRI- 6I	20		BUR-10D	22		CE- 21D	26	
BRI- 7D	20		BUR-11D	22		CE- 22D	26	
BRI- 8I	20		BUR-12	22		CE- 23D	26	
BRI- 9D	20		BUR-13D	22		CE- 24D	26	
BRI-10	20		BUR-14D	22		CE- 25D	26	
BRI-12	20		BUR-15	22		CE- 26D	26	
BRI-13	20		BUR-16	23		CE- 27D	26	
BRI-14	20		BUR-17D	23		CE- 28D	26	
BRI-14D	20		BUR-18D	23		CE- 29D	26	
BRI-15	20		BUR-19D	22		CE- 30D	26	
BRI-16	20		BUR-20D	23		CE- 31D	26	
BRI-17	20		BUR-21D	23		CE- 32D	26	
BRI-18	20		BUR-22D	23		CE- 33D	26	
BRI-18D	20		BUS-1	23		CE- 34D	26	
BRI-19	20					CE- 35D	26	
BRI-20	20		<b>C</b>			CE- 36D	26	
BRI-21	20		C			CE- 37D	26	
BRI-22	20		CA- 1I	23		CE- 38D	26	
BRI-23	20		CA- 1I	24		CE- 39D	26	
BRI-24	20		CA- 2I	24		CE- 40D	26	
BRI-25	20		CA- 3I	24		CE- 41D	26	
BRI-26	21		CA- 4D	24		CE- 42D	26	
BRI-27	20		CA- 4I	24		CE- 43D	26	
BRI-28	21		CA- 5I	24		CE- 44D	26	
BRI-29	21		CA- 6D	24		CE- 45D	26	
BRI-30	21		CA- 7	24		CE- 46D	26	
BRI-31	21		CA- 7D	24		CE- 47D	26	
BRI-32D	21		CA- 8D	24		CE- 48D	26	
BRR-1	17		CA- 8I	24		CE- 49	26	
BRS-1	20		CA- 9I	24		CE- 49D	26	
BRU-1	21		CA-10I	24		CE- 50	26	
BRU-1D	21		CA-11I	24		CE- 51	26	
BS-1I	128		CA-12I	24		CE- 51D	26	
BS-2	128		CA-13D	24		CE- 52	26	
BS-3D	128		CA-14D	24		CE- 53D	27	
BS-4D	128		CA-15I	24		CE- 54	26	
BS-5	128		CAM-1D	128		CE- 55	26	
BS-6	128		CAS-1D	128		CE- 56	26	
BS-7	128		CASAS-1T	23		CE- 57	26	
BS-7D	128		CAT-1P	128		CE- 58	26	
BS-8	128		CAY-1D	24		CE- 59	26	
BS-8D	128		CAY-1I	24		CE- 60	26	
BS-9	128		CAY-2	25		CE- 61	26	

TEXTO	PAG.	PAG.	TEXTO	PAG.	PAG.	TEXTO	PAG.	PAG.
CE- 62	26		CHI- 9D	28		CI -30	30	
CE- 63	26		CHI-10D	28		CI -31	30	
CE- 64	26		CHR- 1	129		CI -32	30	
CE- 65	26		CHR- 2	129		CI -33	30	
CE- 66	26		CHR- 3	129		CI -34	31	
CE- 67	26		CHR- 3P	129		CI -35	30	
CE- 68	26		CHR- 4D	181		CI -36	31	
CE- 69	26		CHR- 4I	181		CI -38D	31	
CE- 70	26		CHR- 5	129		CI -39D	29	
CE- 71	26		CHR- 6	129		CI -41	30	
CE- 72	26		CHR- 6D	129		CI -42	31	
CE- 73	26		CHR- 7	129		CI -43D	30	
CE- 74	26		CHR- 7P	129		CI -44D	29	
CE- 75	26		CHR- 8	129		CI -45D	30	
CE- 76	26		CHR- 8P	129		CI -46D	30	
CE- 77	26		CHR- 9	129		CI -48	30	
CE- 78	26		CHR- 9P	129		CI -49	30	
CE- 79	26		CHR-10	130		CI -DL	31	
CE- 80	26		CHR-10P	130		CI -IL	31	
CE- 81	26		CHR-11	130		CIE-1D	28	
CE- 82	26		CHR-11P	130		CIF-1D	28	
CE- 83	26		CHR-12	130		CIF-2D	28	
CE- 84	26		CHR-13D	130		CIF-3	28	
CE- 85	26		CHR-14	130		CIF-4	28	
CE- 86	26		CHR-14P	130		CIL-1	29	
CE- 87	26		CHR-15	130		CIL-1D	29	
CE- 88	26		CHR-15P	130		CIL-2D	29	
CE- 89	27		CHR-17	130		CIL-3D	29	
CE- 89D	27		CHTZ-1	27		CIL-4	29	
CE- 90D	26		CHU- 1D	28		CIL-4D	29	
CE- 94	27		CHU-10	28		CIL-5D	29	
CE- 96	27		CI - 1D	29		CIS-1D	23	
CE- 97	27		CI - 1I	29		CIS-1I	23	
CE- 98D	27		CI - 2	31		CIS-2	23	
CE- 99D	25		CI - 2I	31		CIS-3	23	
CE-100D	25		CI - 3D	29		CIS-4	23	
CE-101D	25		CI - 4D	29		CIS-5	23	
CE-102	27		CI - 4DP	29		CL-1I	31	130
CE-103	27		CI - 4I	29		CL-2D	130	
CE-104D	27		CI - 4IP	29		CL-2I	130	
CE-105	27		CI - 5DP	29		CL-3I	131	
CE-106	27		CI - 5IP	29		CL-4I	131	
CE-107	27		CI - 6D	29		CL-5D	131	
CE-108	25		CI - 6I	29		CL-6	131	
CE-109D	27		CI - 7D	29		CL-6P	131	
CE-110	25		CI - 8D	31		CL-7P	131	
CE-111D	27		CI - 9D	31		CL-8P	131	
CEM-BP	128		CI -10D	31		CL-9P	131	
CEM-JC	129		CI -11D	31		CLI-1D	131	
CENT-1D	25		CI -12	31		CLU-1D	131	
CENT-1I	25		CI -13	31		CLU-1I	131	
CENT-2D	25		CI -14	29		CLU-2	131	
CENT-2I	25		CI -15	31		CLU-3	131	
CENT-3D	25		CI -15D	31		CLU-4	131	
CER-1	25		CI -16D	31		CLU-5	131	
CF-1D	28		CI -17	29		CMA-1	25	
CF-1I	28		CI -18	31		CMA-1D	25	
CHA-2	27		CI -19D	29		CMA-2	25	
CHA-2D	27		CI -20	29		CMA-2D	25	
CHEK-1	27		CI -20D	29		CN-1D	129	
CHI- 1	28		CI -21	30		CO -1D	33	
CHI- 1T	28		CI -22D	30		CO -M	33	
CHI- 2	28		CI -23D	30		COB-1P	131	
CHI- 3	28		CI -24	30		COB-2	132	
CHI- 4	28		CI -25	30		COM-1D	31	
CHI- 5	28		CI -26	30		COR- 1D	31	
CHI- 6	28		CI -27	31		COR- 1I	31	
CHI- 7D	28		CI -28D	30		COR- 2D	31	
CHI- 8D	28		CI -29	31		COR- 2I	31	

TEXTO	PAG.	PAG.	TEXTO	PAG.	PAG.	TEXTO	PAG.	PAG.
COR- 3	31		<b>D</b>			DAT-17D	180	
COR- 3D	31		DAC-1DP	132		DAT-18	180	
COR- 7	31		DAC-2D	132		DAT-19	180	
COR- 8	31		DAD-1D	34		DAT-19P	180	
COR- 9	32		DAD-1I	34		DAT-20	180	
COR-10	32		DAD-2D	34		DAT-20P	180	
COR-11	32		DAD-2I	34		DAV-1	133	
COR-11D	32		DAD-3D	34		DAV-1P	133	
COR-12	32		DAD-4D	34		DC-1D	40	
COR-13	32		DAD-5D	34		DC-2D	40	
COR-13D	32		DAD-6D	34		DC-3	40	
COR-15D	32		DAE-1P	132		DC-4D	40	
COR-16D	31		DAE-2DP	132		DEF-1D	34	
COR-17D	32		DAE-3DP1	132		DEK-2	34	
COR-18D	31		DAE-3DP2	132		DEK-3	35	
COR-19D	31		DAE-4DP1	132		DIA-1	35	
COR-20	32		DAE-4P1	132		DIA-2	35	
COR-20/25	32		DAE-5P	132		DIA-3	35	
COR-20D	32		DAI-1P	132		DIE-1	35	
COR-21D	31		DAI-2D	132		DLC-1	35	
COR-22D	31		DAL-1P	132		DLC-2	35	
COR-23D	32		DAR-1	133		DLP-1	35	
COR-24	32		DAT- 1D	178		DLP-2	35	
COR-25	32		DAT- 1DP	178		DM-1	35	
COR-25I	32		DAT- 1I	178		DO-2I	39	
COR-26	32		DAT- 1IP	178		DO-3	40	
COR-27D	32		DAT- 2D	178		DO-4	40	
COR-28	33		DAT- 2DP	178		DO-5	40	
COR-29D	33		DAT- 2I	178		DO-5D	40	
COR-30	33		DAT- 2IP	178		DOB-1	133	
COR-31	33		DAT- 3D	178		DOB-1D	133	
COR-32	33		DAT- 3I	178		DOB-2	133	
COR-33	33		DAT- 4D	178		DOB-2D	133	
COR-34	33		DAT- 4I	178		DOB-3	133	
COR-35	33		DAT- 5D	178		DOB-3D	133	
COR-36D	31		DAT- 6	178		DOI-1	39	
COR-37	33		DAT- 6D	178		DOM- 1D	35	
COR-40	33		DAT- 6DP	178		DOM- 1DP	36	
COR-48	31		DAT- 6DP1	178		DOM- 1I	35	
COR-49	31		DAT- 6P	178		DOM- 2D	36	
COR-50/60	33		DAT- 6P1	178		DOM- 3D	36	
COR-50/60I	33		DAT- 7	178		DOM- 3I	36	
COT-1D	34		DAT- 7P	178		DOM- 4	36	
CSB-1D	24		DAT- 7P1	178		DOM- 4D	36	
CSB-2D	24		DAT- 8	179		DOM- 5D	36	
CT-1	184		DAT- 8I	179		DOM- 6D	36	
CT-1P	184		DAT- 8IP	179		DOM- 6I	36	
CT-2	184		DAT- 8IP1	179		DOM- 7D	36	
CT-2P	184		DAT- 8P	179		DOM- 7I	36	
CT-2P1	184		DAT- 9D	179		DOM- 8D	36	
CT-3	184		DAT- 9DP	179		DOM- 9	36	133
CT-3P	184		DAT- 9I	179		DOM- 9D	36	133
CT-4P	184		DAT- 9IP	179		DOM-10D	36	
CUB-1	34		DAT-10	179		DOM-11D	36	
CVL-1D	34		DAT-10P	179		DOM-11I	36	
CVL-1I	34		DAT-11	179		DOM-12	36	
CVL-2D	34		DAT-11D	179		DOM-12D	36	
CVL-2I	34		DAT-11DP	179		DOM-13D	36	
CVL-3D	34		DAT-11P	179		DOM-14D	36	133
CVL-3I	34		DAT-12	179		DOM-15D	37	
CVL-4	34		DAT-13	179		DOM-16D	37	
CVL-5D	34		DAT-13P	180		DOM-17I	37	
CVL-5I	34		DAT-14	179		DOM-18D	37	
CVL-6	34		DAT-14P	180		DOM-20D	37	
CVL-8D	34		DAT-15	180		DOM-21D	37	
CVL-9D	34		DAT-15P	180		DOM-22	37	
			DAT-16	180		DOM-25D	37	
			DAT-17	180		DOM-26	37	
						DOM-26D	37	

TEXTO	PAG.	PAG.	TEXTO	PAG.	PAG.	TEXTO	PAG.	PAG.
DOM-27D/ 1	38		DOM-35D	39		EV- 3D	42	
DOM-27D/ 2	38		DOM-36	39		EV- 3I	42	
DOM-27D/ 3	38		DOM-36D	39		EV- 4D	42	
DOM-27D/ 4	38		DOM-37	39		EV- 6D	42	
DOM-27D/ 5	38		DOM-37D	39		EV- 7D	42	
DOM-27D/ 6	38		DOM-38D	36	133	EV- 8D	42	
DOM-27D/ 7	38		DOM-39	39		EV- 9D	42	
DOM-27D/ 8	38		DOM-40D	39		EV-10	42	
DOM-27D/ 9	38		DOM-41D	37		EV-11	42	
DOM-27D/10	38		DOM-42	39		EV-11D	42	
DOM-27D/11	38		DOM-43	39		EV-12D	43	
DOM-27D/12	38		DOM-44D	37		EV-13D	42	
DOM-27D/13	38		DOM-45	37		EVE-1	42	
DOM-27D/14	38		DOM-46D	37		EVE-1D	42	
DOM-27D/15	38		DOM-48	36		EVE-2D	42	
DOM-27D/16	38		DU-1	133		EVE-3D	42	
DOM-27D/17	38		DUR-1D	40		EX-1D	43	
DOM-27D/18	38		DX-5	35		EZ-1D	43	
DOM-27D/19	38		DX-5D	35		EZ-1I	43	
DOM-27D/20	38		DX-6	35		EZ-2I	43	
DOM-27D/21	38		DX-6D	35		EZ-3D	43	
DOM-27D/22	38					EZ-3I	43	
DOM-27D/23	38					EZ-4D	43	
DOM-27D/24	38					EZ-4I	43	
DOM-27D/25	38					EZ-DS10	43	
DOM-27D/26	38					EZ-DS10E	43	
DOM-27D/27	38					EZ-DS15	43	
DOM-27D/28	38					EZ-DS15R	43	
DOM-27D/29	38							
DOM-27D/30	38							
DOM-27D/31	38							
DOM-27D/32	38							
DOM-27D/33	38							
DOM-27D/34	38							
DOM-27D/35	38							
DOM-27D/36	38							
DOM-27D/37	38							
DOM-27D/38	38							
DOM-27D/39	38							
DOM-27D/40	38							
DOM-27D/41	38							
DOM-27D/42	38							
DOM-27D/43	38							
DOM-27D/44	38							
DOM-27D/45	38							
DOM-27D/46	38							
DOM-27D/47	38							
DOM-27D/48	38							
DOM-27D/49	38							
DOM-27D/50	38							
DOM-27D/51	38							
DOM-27D/52	38							
DOM-27D/53	38							
DOM-27D/54	38							
DOM-27D/55	38							
DOM-27D/56	38							
DOM-27D/57	38							
DOM-27D/58	38							
DOM-27D/59	38							
DOM-27D/60	38							
DOM-27D/61	38							
DOM-28	38							
DOM-29	38							
DOM-30	38							
DOM-31	38							
DOM-32	39							
DOM-33	39							
DOM-34	39							
DOM-35	39							
			<b>E</b>					
			EC-1	40				
			EC-1D	40				
			ECH-1	133				
			EG-1	40				
			EG-2	40				
			EI-1D	40				
			EI-2D	40				
			ELZ- 1D	40				
			ELZ- 2	40				
			ELZ- 3D	40				
			ELZ- 4	40				
			ELZ- 4D	40				
			ELZ- 5D	40				
			ELZ- 6D	41				
			ELZ- 8D	41				
			ELZ- 9	41				
			ELZ-10	41				
			ELZ-10D	41				
			ELZ-11D	41				
			ELZ-12D	41				
			EMK-1	41				
			ER-1D	41				
			ES-1D	41				
			ES-1I	41				
			ESL-1D	41				
			ESS-1	41				
			ESS-2	41				
			ESS-3	41				
			ESS-4	41				
			ETS-1D	41				
			EU- 1	42				
			EU- 2	42				
			EU- 3	42				
			EU- 4	42				
			EU- 4D	42				
			EU- 6	42				
			EU- 7	42				
			EU- 7D	42				
			EU- 8D	42				
			EU- 9	42				
			EU-10D	42				
			EUR-1D	42				
			EV- 1	42				
			EV- 2	42				
			EV- 2I	42				
						<b>F</b>		
						FA-1	45	
						FA-1D	45	
						FAB-1	133	
						FAB-2	133	
						FAC- 1D	44	
						FAC- 1I	44	
						FAC- 2D	44	
						FAC- 2I	44	
						FAC- 3D	44	
						FAC- 3I	44	
						FAC- 4D	44	
						FAC- 5D	44	
						FAC- 6D	44	
						FAC- 7D	44	
						FAC- 8D	44	
						FAC- 9D	44	
						FAC-10D	44	
						FAC-11D	44	
						FAC-12D	44	
						FAC-13D	44	
						FAC-14D	44	
						FAC-15	44	
						FAC-18	44	
						FAC-19	45	
						FAC-20D	45	
						FAC-21	45	
						FAC-21D	45	
						FAC-22D	45	
						FAC-23	45	
						FAI-A	134	
						FAI-B	134	
						FAI-C	134	
						FAI-D	134	
						FAIN-1I	45	
						FAM-1	45	
						FAM-2	45	
						FAN-1	45	
						FAN-1D	45	

TEXTO	PAG.	PAG.	TEXTO	PAG.	PAG.	TEXTO	PAG.	PAG.
FAR-1D	134		FF-11	46		FO - 8DP1	135	
FAR-1I	134		FI- 1	142		FO - 9D	136	
FAR-2D	134		FI- 1P	142		FO - 9DP	136	
FAR-2I	134		FI- 1P8	142		FO -10P	136	
FAR-3	134		FI- 2D	142		FO -11D	136	
FAR-3D	134		FI- 2DP3	142		FO -12	136	
FAR-4D	134		FI- 3	142		FO -12P	136	
FAS-1	45		FI- 3D	142		FO -13DP	136	
FAV-1	45		FI- 3DP	142		FO -14DP	136	
FAV-2	45		FI- 3DP1	142		FO -15D	136	
FB- 1	43		FI- 3DP2	142		FO -15DP	136	
FB- 2D	43		FI- 3DP3	142		FO -17P	136	
FB- 2I	43		FI- 3DP4	142		FO -18D	136	
FB- 3	43		FI- 3DP5	142		FO -20D	137	
FB- 4	43		FI- 4D	143		FO -22P	137	
FB- 5	43		FI- 5D	143		FO -ANP	137	
FB- 6	43		FI- 5I	143		FO -D	137	
FB- 7	43		FI- 6I	143		FO -E/TC	137	
FB- 8	43		FI- 6IP	143		FO -E/TCP	137	
FB- 9	43		FI- 6IP1	143		FO -FHP	137	
FB-10	43		FI- 6IP2	143		FO -FK	137	
FB-11	43		FI- 6IP3	143		FO -FKP	137	
FB-12	43		FI- 6IP4	142		FO -FR	137	
FB-13	44		FI- 7I	143		FO -FRP	137	
FB-14	44		FI- 8I	143		FO -OA	137	
FB-15	44		FI- 8IP	143		FO -OL	137	
FB-16	44		FI- 8IP1	143		FO -OR	137	
FB-17	44		FI- 9I	143		FO -PN	137	
FB-18	44		FI- 9IP	143		FO -PRL	137	
FB-19	43		FI-10	142		FO -PRR	137	
FB-20	43		FI-10P	142		FO -SR	150	
FB-21	43		FI-11	144		FO -TC	138	
FB-22	43		FI-11KP	144		FO -TX	138	
FB-23	43		FI-11P	144		FO -TX1	138	
FB-24	43		FI-12	142		FO -TX1P	138	
FB-25	43		FI-12P	142		FO -TX2	138	
FB-26	43		FI-12P1	142		FO -TX2P	138	
FB-27	44		FI-12P3	142		FO -TXKP	138	
FB-28	44		FI-13	144		FO -TXP	138	
FB-29	43		FI-13P	144		FO -XL	137	
FB-31	43		FI-13P1	144		FO -XR	137	
FB-32	44		FI-13P7	144		FON-1E	47	
FB-33	44		FI-14P	144		FON-2E	48	
FB-34	44		FI-15	144		FON-3E	48	
FB-35	44		FIA-1	135		FON-4E	48	
FEC-1D	46		FIA-2	135		FON-5E	48	
FEC-2	46		FIC- 1	47		FON-6E	47	
FEC-3D	46		FIC- 2	47		FORTIS -2I	48	
FED-1	46		FIC- 5	47		FR- 1D	48	
FED-2	46		FIC- 7	47		FR- 2	48	
FED-3	46		FIC- 8	47		FR- 4	48	
FEM-1D	134		FIC- 9	47		FR- 7D	48	
FEM-1I	134		FIC-18	47		FR- 8	48	
FEM-2D	134		FIS-1D	47	135	FR- 9D	48	
FEM-2I	134		FLO-1	47		FR-11D	48	
FEM-3D	134		FLO-1D	47		FTE-1	48	
FEM-3I	134		FO - 1	135		FTE-1D	48	
FER-1	46		FO - 2	135		FTH- 1	48	
FF- 1	46		FO - 3	135		FTH- 1D	48	
FF- 1D	46		FO - 3D	135		FTH- 2	48	
FF- 2	46		FO - 3DP	135		FTH- 3	48	
FF- 2D	46		FO - 3P	135		FTH- 4	49	
FF- 3	46		FO - 4P	135		FTH- 5	49	
FF- 5D	46		FO - 5	129		FTH- 6	49	
FF- 6	46		FO - 6P	135		FTH- 7	49	
FF- 7D	46		FO - 7P	135		FTH- 8	48	
FF- 8D	47		FO - 8	135		FTH- 8D	48	
FF- 9D	47		FO - 8D	135		FTH- 9	49	
FF-10D	46		FO - 8DP	135		FTH-10	49	

TEXTO	PAG.	PAG.	TEXTO	PAG.	PAG.	TEXTO	PAG.	PAG.
FTH-11D	49		GLO- 6	52		GM-K	141	
FTH-12D	49		GLO- 6D	52		GM-KP	141	
FTH-13D	49		GLO- 7	52		GR-1D	53	
FTH-14D	49		GLO- 7D	52		GR-1I	53	
FTH-15	49		GLO- 8	52		GR-2D	53	
FTH-16	49		GLO- 8D	52		GR-2I	53	
FTH-17D	50		GLO- 9D	52		GR-3D	53	
FTH-18	50		GLO-10	52		GR-3I	53	
FTH-19	50		GLO-11	52		GR-4D	53	
FTH-20D	50		GLO-12D	53		GR-4I	53	
FTH-21	49		GM- 1P	138		GR-5D	53	
FTH-22	49		GM- 2	138		GR-5I	53	
FV-1D	45		GM- 2P	138		GR-6	53	
<b>G</b>			GM- 3P	139		GR-6D	53	
GAB-1D	50		GM- 4	139		GR-7	53	
GAB-1I	50		GM- 4P	139		GR-7D	53	
GAB-2	50		GM- 4P1	139		GR-8	53	
GAS-1	138		GM- 5	139		GTV-1D	53	
GAS-1D	138		GM- 5P	139		GTV-2	53	
GAT-1	50		GM- 6	139		GTV-2D	53	
GAT-2D	50		GM- 6P	139		GTV-3D	53	
GAT-3D	50		GM- 7	139		GTV-4D	53	
GBZ-1	50		GM- 7P	139		GUA-1	53	
GE-1D	50		GM- 8	139		GUA-1D	53	
GE-2	50		GM- 8P	139		GUA-2	53	
GE-3D	50		GM- 9	139		GUA-2D	53	
GE-4D	51		GM- 9P	139		GUA-3	53	
GE-5	51		GM-10	139		GUA-3D	53	
GE-5D	51		GM-10P	139		<b>H</b>		
GE-6	51		GM-11	139		HA-1D	145	
GE-6D	51		GM-11P	139		HA-1I	145	
GE-7	51		GM-12	139		HAF-1	53	
GE-8	51		GM-12P	139		HAF-1D	53	
GE-9	51		GM-13	139		HAF-2D	53	
GE-10D	51		GM-13P	139		HAF-3D	54	
GE-11	51		GM-14	139		HAF-4	53	
GEA-1	51		GM-14P	139		HAG-1D	54	
GEA-2D	51		GM-15D	140		HAK-1D	54	
GEA-3	51		GM-15DP	140		HAK-2D	54	
GEA-4D	51		GM-16P	140		HAK-3	54	
GEB-1D	51		GM-17P	140		HAK-4	54	
GH-1	141		GM-18P	140		HAK-5	54	
GH-GX	141		GM-19P	140		HAR-1I	54	
GH-HX	141		GM-20P	140		HB-1	54	
GH-PS	141		GM-21	140		HD-1	145	
GIB-1D	51		GM-21P	140		HD-1D	145	
GIOB-1D	144		GM-22	140		HD-2	145	
GIOB-1DP	144		GM-22P	140		HD-2D	145	
GIOB-2I	144		GM-23	140		HD-3	145	
GIOB-2IP	144		GM-23P	140		HD-3D	145	
GIOB-3P	144		GM-24	140		HEC-1	54	
GIU-1	51		GM-24P	140		HEK-1	54	
GIU-1D	51		GM-25	141		HEK-2	54	
GIU-2	51		GM-25P	141		HEK-3	54	
GIU-2D	51		GM-26	141		HEK-4	54	
GIU-3D	51		GM-A	141		HEN-1	54	
GIU-4	51		GM-AP	141		HEN-1D	54	
GLA-1D	52		GM-B	141		HOND- 1	145	
GLO- 1D	52		GM-BP	141		HOND- 1P	145	
GLO- 1I	52		GM-C	141		HOND- 2	145	
GLO- 2	52		GM-CP	141		HOND- 2P	145	
GLO- 2D	52		GM-D	141		HOND- 3D	145	
GLO- 3	52		GM-DP	141		HOND- 3I	145	
GLO- 3D	52		GM-E	141		HOND- 4D	145	
GLO- 4D	52		GM-EP	141		HOND- 4DP	145	
GLO- 4I	52		GM-H	141		HOND- 4DP1	145	
GLO- 5I	52		GM-HP	141		HOND- 4DP2	145	
			GM-J	141				
			GM-JP	141				

TEXTO	PAG.	PAG.	TEXTO	PAG.	PAG.	TEXTO	PAG.	PAG.
HOND- 4I	145		HU -SR	151		IMB-1D	58	
HOND- 4IP	145		HU -SU	151		IMS- 3	183	
HOND- 4IP1	145		HU -SX	151		IMS- 3C	159	
HOND- 5D	145		HU -SY	151		IMS- 3P	183	
HOND- 5I	145		HU -SZ	151		IMS- 5	183	
HOND- 6D	145		HUD-1	148		IMS- 5C	159	
HOND- 6I	145		HUD-1D	148		IMS- 5P	183	
HOND- 7D	145		HUD-2D	55	148	IMS- 6D	159	
HOND- 7I	145		HUW-1	55	157	IMS- 6I	159	
HOND- 8D	146		HUW-1D	55	157	IMS- 7	159	
HOND- 8I	146		HUW-N	55	157	IMS- 7P	159	
HOND- 9D	146		HY-1	157		IMS- 8	159	
HOND- 9I	146		HY-2	157		IMS- 9	159	
HOND-10	146		HY-2P	158		IMS-10	159	
HOND-10P	146		HY-3	158		IMS-11P	159	
HOND-11	146		HY-3D	158		IMS-12	160	
HOND-11P	146		HY-3DP	158		IMS-MER	160	
HOND-12	146		HY-3DP1	158		IN-1	192	
HOND-12P	146		HY-3P2	158		IN-4	192	
HOND-13	146		HY-3P3	158		IN-5	192	
HOND-13P	146		HY-4	158		INCE-1E	58	
HOND-14	146		HY-4P	158		INCE-2E	58	
HOND-14P	146		HY-4P2	158		ING-6	58	
HOND-15	146		HY-5	158		ING-A	58	
HOND-15P	146		HY-5P	158		ING-D	58	
HOND-16D	146		HY-6D	158		ING-N	58	
HOND-16DP	146		HY-6DP	159		ING-S	58	
HOND-16DP1	147		HY-7P	159		ING-W	58	
HOND-17P	147		HY-8	159		INT-1	58	
HOND-18DP	145		HY-8P	159		INT-1D	58	
HOND-18P	145		HY-9P2	159		IR-1P	58	
HOND-19	147					IS- 1D	58	
HOND-19D	147		<b>I</b>			IS- 1I	58	
HOND-19DP	147					IS- 2D	58	
HOND-19P	147		IB-1	55		IS- 2I	58	
HOND-20	147		IB-2	55		IS- 3D	58	
HOND-20D	147		ICA-1	55		IS- 3I	58	
HOND-20DP	147		ICA-4IP	55		IS- 4	58	
HOND-20P	147		ICA-5IP	55		IS- 5D	58	
HOND-21	147		ICS-1D	55		IS- 6D	58	
HOND-22DP	147		ICS-2D	55		IS- 7D	58	
HOND-23	147		IF- 1I	55		IS- 8	58	
HOND-24P	147		IF- 2	55		IS- 8D	58	
HOND-25P2	145		IF- 3P	56		IS-10P	59	
HOND-26DP1	147		IF-15	56		IS-14D	59	
HOND-26P1	147		IF-35	56		ISU-1	160	
HOND-27D	147		IF-45/55	56		ISU-2	160	
HOND-28DP	148		IF-60/70	56		ITO-1D	59	
HOND-28P	148		IF-D20	56		ITO-2D	59	
HOND-29DP	148		IF-D25	56		IV-1	59	
HOND-29P	148		IF-D30	56		IV-2D	59	
HOND-30DP2	145		IF-I20	56				
HOND-30P2	145		IF-I25	56		<b>J</b>		
HOR-1	54		IF-I30	56		JAR-1D	59	
HOR-2	55		IF-I40	56		JAR-1E	59	
HOR-2D	55		IF-I40L	56		JAR-1I	59	
HU -1	150		IF-I50	56		JAR-2D	59	
HU -2P	150		IF-I60/70	56		JAR-2I	59	
HU -AN	150		ICS-1	56		JAR-3	59	
HU -DF	150		IL-1D	57		JAR-4D	59	
HU -DFP	150		IL-1I	57		JAR-5D	59	
HU -DFP1	150		IL-2	57		JAR-5I	59	
HU -DHP	150		ILC-1D	57		JAR-6	59	
HU -DNP	151		ILC-2D	57		JAR-6D	59	
HU -HAAP1	151		ILC-3	57		JAU-1P	188	
HU -MN	151		ILL-1	57		JIN-1D	59	
HU -MNP	151		ILL-2	57		JIP-1D	60	
HU -P	151		ILL-2D	57		JIP-1I	60	
HU -SC	151		IMB-1	58				

TEXTO	PAG.	PAG.	TEXTO	PAG.	PAG.	TEXTO	PAG.	PAG.
JIS-1D	60		KA- 2	62		KIR-2	65	
JIS-2I	60		KA- 3	62		KP-1	65	
JIS-3D	60		KA- 4	62		KRA-1D	65	
JIS-3I	60		KA- 5	62		KRA-2	65	
JIS-4P	60		KA- 6	62		KRE-1D	65	
JMA-1D	114		KA- 7	62		KWI-1	65	
JMA-1I	114		KA- 8	62		KWI-2D	65	
JMA-2D	114		KA-10	62		KYM-1DP	161	
JMA-2I	114		KA-11	62		KYM-1P	161	
JMA-3D	114		KAE- 1	63				
JMA-3I	114		KAE- 2	63		<b>L</b>		
JMA-4D	114		KAE- 3	63		LA-1D	161	
JMA-4I	114		KAE- 3D	63		LA-1DP	161	
JMA-9D	114		KAE- 4	63		LA-2	161	
JMA-9I	114		KAE- 5	63		LA-2P	162	
JNG-1	61		KAE- 6	63		LA-3D	162	
JNG-1D	61		KAE- 6D	63		LA-3DP	162	
JNG-2D	61		KAE- 7	63		LA-4D	162	
JNG-3	61		KAE- 7D	63		LA-4DP	162	
JO-1	60		KAE- 8	63		LAF-1D	65	
JOM-1D	60		KAE- 8D	63		LAP- 1	65	
JPM-1D	61		KAE- 9	63		LAP- 1E	65	
JPM-1E	61		KAE- 9D	63		LAP- 2D	65	
JPM-1I	61		KAE-10D	63		LAP- 2E	65	
JPM-2D	61		KAL-1	63		LAP- 3D	65	
JPM-2E	61		KAL-2D	63		LAP- 3I	65	
JPM-2I	61		KAM-1	160		LAP- 4	66	
JPM-3D	61		KAM-1D	160		LAP- 5D	66	
JPM-4	61		KAP-1D	63		LAP- 6	65	
JPM-4D	61		KAP-2D	63		LAP- 7D	65	
JTF-1I	61		KAW-1D	160		LAP- 8D	66	
JTF-2I	61		KAW-1I	160		LAP- 9	66	
JTF-3	61		KAW-2D	160		LAP- 9D	66	
JTF-4	61		KAW-2I	160		LAP-10D	66	
JU-1	62		KAW-3	160		LAP-11D	66	
JU-2	62		KAW-4	160		LAP-13P	66	
JUNI-1	61		KAW-5	160		LAP-17P	66	
JUNI-1D	61		KAW-5P	160		LAP-20P	66	
JUNI-2	61		KAW-6DP	160		LAP-21P	66	
JUNI-2D	61		KAW-6P	160		LAP-22P	66	
JUNI-3D	61		KAW-7P	160		LAP-23P	66	
JUNI-4D	61		KAW-8	161		LAP-28D	66	
JUNI-5D	61		KAW-8D	161		LAP-29D	66	
JUNI-6D	61		KAW-9P	161		LAP-30D	66	
JUNI-7D	61		KAZ-1	63		LAP-34D	66	
JUNI-8D	61		KAZ-2	63		LAP-42D	66	
JUNI-9D	61		KAZ-3	64		LAP-43D	66	
JUZU-1	62		KAZ-4	64		LAP-44D	66	
JV-1D	62		KAZ-5	64		LAP-45D	66	
JV-1I	62		KAZ-5D	64		LAP-46D	66	
JV-2	62		KAZ-6	64		LAP-96D	66	
JV-3D	62		KAZ-7	64		LAR-1I	67	
JV-3I	62		KE-1	64		LAS - 1D	67	162
JV-4I	62		KE-3	64		LAS - 2	67	162
JV-5I	62		KE-4	64		LAS - 3	67	162
JV-6	62		KEN-1	161		LAS - 4	67	162
JV-7	62		KEN-1D	161		LAS - 4D	67	162
JV-7D	62		KFV-1	64		LAS - 5	67	162
JWL-1D	60		KI-1D	161		LAS - 5D	67	162
JWL-2D	60		KI-1DP	161		LAS - 6	67	162
JWL-3D	60		KI-1DP1	161		LAS - 6D	67	162
JWL-4D	60		KI-2D	161		LAS - 7	67	
JWL-5	60		KI-3DP	161		LAS - 7	67	
JWL-6	60		KI-3P	161		LAS - 8	67	
JWL-7D	61		KIC-1	64		LAS - 9	67	
			KIF-1	64		LAS -10	67	
			KIF-1D	64		LAS -11	67	
			KIF-2D	64		LAS -11D	67	
			KIR-1D	64		LAS -12D	67	
<b>K</b>								
KA- 1	62							

TEXTO	PAG.	PAG.	TEXTO	PAG.	PAG.	TEXTO	PAG.	PAG.
LAS -AX	67	162	LF-32	71	164	LMP-4P1	163	
LAS -AX/L	67		LF-33D	72		LMP-5	163	
LAS -BT	162		LF-34	72		LMP-5P	163	
LAS -CR	162		LF-35	73		LMP-5P1	163	
LAS -FH	67	162	LF-BL	164		LO-1D	70	
LAS -KT	67	162	LF-RO	164		LO-1I	70	
LAS -P	162		LF-ROP	164		LO-2D	70	
LAS -R	67	162	LF-SL	164		LO-2I	70	
LAS -RC	162		LF-SLP	164		LO-3D	70	
LAS -SX	68	163	LF-WB	165		LO-4D	70	
LAS -TB	162		LF-WBP	165		LOC-1D	70	
LAS -TK	67	162	LF-WR	165		LPO-1	66	
LAS -TX	68	163	LIN- 1D	68		LPO-2	66	
LAS -U	67	162	LIN- 1I	68		LUC-1D	73	
LAS -V	67	162	LIN- 2	68		LUC-2	73	
LAS -X	67	162	LIN- 3D	68		LUMA-1D	73	
LAS -XS	68	163	LIN- 3I	68		LUMA-1I	73	
LAS -XY	68	163	LIN- 4D	68		LUMA-2D	73	
LAS -Y	67	162	LIN- 4I	68		LUMA-2I	73	
LASB-1	68		LIN- 5D	68		LUMA-3D	73	
LASB-1D	68		LIN- 5I	68		LUMA-3I	73	
LASB-2	68		LIN- 6D	68		LUMA-4D	73	
LASB-2D	68		LIN- 6I	68		LUMA-4I	73	
LASB-3D	68		LIN- 7D	68		LWO-1	70	
LB-1	70		LIN- 7I	68		LWO-1D	70	
LB-1D	70		LIN- 8D	68		LWO-2D	70	
LB-2D	70		LIN- 8I	68		LYF-1T	73	
LB-3	70		LIN- 9	68		LYF-2T	73	
LB-3D	70		LIN-10D	68				
LEG-1D	68		LIN-10I	68				
LF- 1D	70	163	LIN-11D	69		<b>M</b>		
LF- 1I	70	163	LIN-11I	69		MA-5D	73	
LF- 2	70	163	LIN-12D	68		MAR- 1P	165	
LF- 3	163		LIN-12I	68		MAS- 1	73	
LF- 4I	70	163	LIN-13	69		MAS- 1D	73	
LF- 5	71	164	LIN-14D	68		MAS- 2D	73	
LF- 5D	71	164	LIN-14I	68		MAS- 3D	74	
LF- 6	164		LIN-15D	68		MAS- 4D	74	
LF- 7	71	164	LIN-15I	68		MAS- 5D	74	
LF- 7D	71	164	LIN-16	68		MAS- 6	74	
LF- 8	71	164	LIN-16D	68		MAS- 7	74	
LF- 8D	71	164	LIN-17	68		MAS- 7D	74	
LF- 9	164		LIN-17D	68		MAS- 8	74	
LF-10	71		LIN-18	68		MAS- 9	74	
LF-11	71	164	LIN-18D	68		MAS- 9D	74	
LF-11D	71	164	LIN-19D	68		MAS-10	74	
LF-12	70	163	LIN-20D	68		MAS-10D	74	
LF-12D	70	163	LIN-21D	68		MAS-11	74	
LF-13	71		LIP- 1D	69		MAS-11D	74	
LF-13D	71		LIP- 1I	69		MAS-12D	74	
LF-14D	71		LIP- 2	69		MAS-13D	74	
LF-15	71	164	LIP- 2D	69		MAS-15P	74	
LF-15D	71	164	LIP- 3	69		MAZ- 1D	165	
LF-16	71		LIP- 4	69		MAZ- 1I	165	
LF-17	71	164	LIP-28D	69		MAZ- 2D	165	
LF-18D	71		LIP-33	69		MAZ- 2DP	165	
LF-19	71		LIT-1I	69		MAZ- 2I	165	
LF-20	71		LIT-2D	69		MAZ- 2IP	165	
LF-21	72		LIT-3D	69		MAZ- 3D	165	
LF-22	72		LIT-5D	70		MAZ- 3DP	165	
LF-23	72		LIT-5I	70		MAZ- 3I	165	
LF-24	72		LMP-1	163		MAZ- 3IP	165	
LF-25	72		LMP-1P	163		MAZ- 4	165	
LF-26	72		LMP-2	163		MAZ- 4P	165	
LF-27	72		LMP-2P	163		MAZ- 5D	165	
LF-28	72	164	LMP-3	163		MAZ- 5DP	166	
LF-29D	72		LMP-3P	163		MAZ- 6	166	
LF-30	72		LMP-4	163		MAZ- 6D	166	
LF-31	72		LMP-4P	163		MAZ- 6DP	166	

TEXTO	PAG.	PAG.	TEXTO	PAG.	PAG.	TEXTO	PAG.	PAG.
MAZ- 6P	166		ME -HY	153		MIT- 6	168	
MAZ- 7D	166		ME -HYP	153		MIT- 6P	168	
MAZ- 7DP	166		ME -HZ	152		MIT- 7	168	
MAZ- 7DP1	166		ME -HZP	152		MIT- 7P	168	
MAZ- 8D	166		ME -L	153		MIT- 8D	168	
MAZ- 8DP	166		ME -NU	153		MIT- 8DP	168	
MAZ-11D	166		ME -NUP	153		MIT- 9	168	
MAZ-11DP1	166		ME -NY	153		MIT-10	168	
MAZ-13D	166		ME -NYP	153		MIT-11D	168	
MAZ-13DP	166		ME -S	153		MIT-12	169	
MAZ-13DP1	167		ME -SP	153		MIT-13D	169	
MAZ-14D	167		ME -VA	153		MIT-14D	169	
MAZ-15D	167		MEC-5D	76		MIT-15P	168	
MAZ-16	167		MEL-1	76		MIW-1	78	
MBL-1	79		MEL-2D	76		MIW-2	78	
MBL-1D	79		MEL-3	76		MIW-3	78	
MCH-1	77		MEL-4	76		MIW-4	78	
MCH-1D	77		MEL-4D	76		MLM-1D	78	
MCH-2	77		MEL-5P	76		MLM-2	78	
MCH-2D	77		MER- 1D	76		MLM-3	78	
MCL-1D	74		MER- 1T	76		MLM-4	78	
MCM- 1	74		MER- 2I	76		MLM-5	78	
MCM- 2D	74		MER- 3I	76		MNO-1D	79	
MCM- 2I	74		MER- 4I	76		MOG-1D	79	
MCM- 3D	75		MER- 5I	76		MON-1D	79	
MCM- 3I	75		MER- 6I	76		MON-1I	79	
MCM- 4D	75		MER- 7I	76		MON-2D	79	
MCM- 4I	75		MER- 8I	76		MON-2I	79	
MCM- 4SS	75		MER- 9I	76		MOS-1	169	
MCM- 5D	75		MER-10I	76		MP-1D	79	
MCM- 5I	75		MER-11I	76		MP-1I	79	
MCM- 6	75		MER-12I	76		MQ-1D	73	
MCM- 7	75		MER-13I	76		MQ-1I	73	
MCM- 8	75		MER-14I	76		MR-1	79	
MCM-10	75		MER-15	76		MR-2	79	
MCM-11S	75		MER-16	77		MR-3	79	
MCM-12D	75		MER-16D	77		MSV-1	80	
MCM-13D	75		MER-17	77		MSV-2	80	
MCM-16	75		MER-18	77		MT-AG	79	
MCM-18D	75		MER-18	77		MT-AGP	79	
MCM-24B	76		MERI-1DP	167		MT-CG	79	
MCM-24C	76		MET-2D	77		MT-CGP	79	
MCM-24D	76		MEZ-1D	77		MT-DGP	79	
MCM-24E	76		MG-6D	31		MT-EG	79	
MCM-24F	76		MG-6I	31		MT-EGP	79	
ME - 1	151		MG-6S	31		MT-GG	79	
ME - 1P	151		MG-9	31		MT-GGP	79	
ME - 2P	151		MGA-1	77		MTL-1	77	
ME - 3P	151		MGA-1D	77		MTO-1	77	
ME - 4P	151		MI-1D	77		MUL-T2P	80	
ME - 5P	152		MI-2D	77		MUL-T3P1	80	
ME - 6P	152		MI-3D	78		MUL-T3PL	80	
ME - 7P	152		MI-4D	78		MUL-T4P	80	
ME - 8P	152		MIL-1	78		MUL-T5P	80	
ME - 9P	152		MIL-2	78		MUL-T6	80	
ME - 10P	152		MIN-1D	78		MUL-T6D	80	
ME - 11P	152		MIT- 1D	167				
ME - 12P	152		MIT- 1DP	167		<b>N</b>		
ME - 13DP	152		MIT- 1I	167		NE- 1	169	
ME - 14P	152		MIT- 1IP	167		NE- 1D	169	
ME -HD	152		MIT- 2D	167		NE- 1DP	169	
ME -HDP	152		MIT- 2DP	167		NE- 1P	169	
ME -HF	152		MIT- 2I	167		NE- 2	169	
ME -HFP	152		MIT- 2IP	167		NE- 3	169	
ME -HM	152		MIT- 3	167		NE- 3D	169	
ME -HMLP	153		MIT- 3P	167		NE- 3P	169	
ME -HMP	152		MIT- 4	167		NE- 3P1	169	
ME -HU	153		MIT- 4P	168		NE- 3P2	169	
ME -HUP	153		MIT- 5	168				
			MIT- 5P	168				



TEXTO	PAG.	PAG.	TEXTO	PAG.	PAG.	TEXTO	PAG.	PAG.
PFA-5	84		RI-3I	86		RU- 3D	88	
PGO-1	180		RIG-1D	86		RU- 4D	88	
PHI-52	84		RIO-1D	86		RU- 5D	88	
PIC-1E	84		RO- 1D	86	181	RU- 5I	88	
PIC-8D	84		RO- 1DS	181		RU- 6I	88	
PJ-1	180		RO- 1I	86	181	RU- 7D	88	
PJ-2	181		RO- 1IS	181		RU- 8D	88	
PJ-2P	181		RO- 2D	86	181	RU- 9D	88	
PJ-3	181		RO- 2I	86	181	RU- 9I	88	
PJ-K	181		RO- 3	181		RU-10D	88	
PJ-KP	181		RO- 4D	86	181	RU-11D	88	
PLL-1	181		RO- 4I	86	181	RU-12D	88	
PO -1P	155		RO- 5D	86	182	RU-13D	88	
PO -2P	155		RO- 5I	86	182	RU-14D	88	
PO -HC	155		RO- 6D	86	181	RU-15	88	
PO -HCP	155		RO- 6I	86	181	RU-16D	89	
PO -NC	155		RO- 7D	87	182	RU-GC	89	
PO -NCP	155		RO- 7I	87	182	RU-GK	89	
POL-3TEC	84		RO- 8D	87	182	RU-GK7	88	
POL-4E	84		RO- 8I	87	182	RU-GL	89	
POL-5TEC	84		RO- 9D	87		RU-GL7	88	
POS-1DP	181		RO- 9I	87		RU-GM	89	
PR- 1	84		RO-10D	87		RU-GM7	88	
PR- 1D	84		RO-10I	87		RU-GS	89	
PR- 2	84		RO-11D	87	182	RU-GS7	88	
PR- 3	84		RO-11I	87	182	RU-K	88	
PR- 4D	84		RO-12D	87	182	RU-KD	88	
PR- 4I	84		RO-12I	87	182	RU-L	88	
PR- 5D	85		RO-14	182		RU-M	88	
PR- 5I	85		RO-15	182		RUS-1	89	
PR- 6	85		RO-16D	87	182	RUS-2	89	
PR- 7	85		RO-16I	87	182			
PR- 8	85		RO-17	182		<b>S</b>		
PR- 9	85		RO-18I	87		SA-1	89	
PR- 9D	85		RO-19D	87		SA-1D	89	
PR-10	84		RO-19I	87		SA-2	89	
PR-11	84		RO-20D	87		SA-3D	89	
PR-12	85		RO-20I	87		SA-3I	89	
PR-13	85		RO-21D	87		SA-4	89	
PR-14	85		RO-21I	87		SAA-1P1	182	
PR-15D	85		RO-22I	87		SAA-2P	182	
PR-16	85		RO-23D	87		SAA-AC	183	
PR-16D	85		RO-24D	87		SAA-ACP	183	
PR-17D	85		RO-24I	87		SABT-1	89	
PR-18	85		RO-25D	87		SAG-1T	104	
PR-19	85		RO-25I	87		SAM-1D	89	
PR-20	85		RO-26D	87		SAM-2D	89	
PR-20D	85		RO-26I	87		SAR-1	90	
PRE-1I	181		RO-27D	87		SAR-1D	90	
PRE-2I	181		RO-27I	87		SAR-2D	90	
PRE-3	181		RO-28D	87		SAR-3D	90	
<b>R</b>			RO-28I	87		SAR-4	90	
RAZ-1D	86		RO-29D	87		SAR-4D	90	
RE-1	85		RO-30	87	182	SAR-5D	90	
RE-1D	85		RO-30D	87	182	SAR-6	90	
RE-2D	85		RO-31D	87		SAR-6D	90	
RE-3D	86		RO-32D	87	182	SAT-1D	90	
REG-1D	85		RO-33	87	182	SAT-2	90	
REX-1D	86		RO-34D	88		SCH-1D	91	
RGM-1D	86		RO-36D	88		SCO-1	15	
RGM-II	86		RO-37	88		SCR-1	91	
RGM-2	86		RO-37D	88		SEA-1	91	
RI-1D	86		ROS-1D	182		SEA-2	91	
RI-1I	86		ROS-2	182		SE-AHP	155	
RI-2D	86		RSS-1	89		SE-AN	155	
RI-2I	86		RSS-2D	89		SEL-1D	91	
RI-3D	86		RU- 1D	88		SEL-1I	91	
			RU- 2D	88		SEL-2D	91	
			RU- 2I	88				

TEXTO	PAG.	PAG.	TEXTO	PAG.	PAG.	TEXTO	PAG.	PAG.
SEL-2I	91		SLG-11	90		STR-1	95	
SEL-3D	91		SLG-12	90		STR-2	95	
SEL-4D	91		SLG-13	90		STR-3	186	
SH-1I	92		SLG-14	90		STR-4	95	186
SHA-1	92		SLG-15	90		STS- 1D	95	
SHI-1	92		SLG-16	91		STS- 1DP	95	
SHI-1D	92		SLG-17	91		STS- 1I	95	
SHI-2D	92		SLG-18	91		STS- 2D	186	
SHR-1	90		SLG-19	91		STS- 2DP	186	
SI-1D	185		SLG-20	91		STS- 3D	96	
SI-2D	186		SLG-21	90		STS- 3I	96	
SI-3	186		SLG-22	90		STS- 4D	96	
SI-3D	186		SLG-23	90		STS- 4DP	96	
SI-4	186		SLG-24	90		STS- 5D	186	
SI-4D	186		SLG-25	90		STS- 5DP	186	
SI-5D	186		SM-1	92		STS- 6D	96	
SIM- 900	131		SM-2	92		STS- 7D	96	
SIM-1200	125		SM-3	92		STS-11	186	
SIP-1	185		SM-3D	92		STS-12D	96	
SIP-2	185		SM-4	92		STS-13D	96	
SIP-3	185		SM-4D	92		STS-21D	96	
SIS-1	92		SOF-1	93		STS-28	95	
SIS-2	92		SOF-2	93		STS-35	96	
SIS-3	92		SOFI-1D	93		STS-38	96	
SIS-4D	92		SOFI-1I	93		STS-B1	96	
SIS-5D	93		SOFI-2D	93		STS-T14	96	
SIS-6	92		SOFI-2I	93		STS-TV3	96	
SIS-6D	92		SOFI-3I	93		STS-TV5	96	
SIS-7D	92		SOFI-4	93		STS-TV8	96	
SIS-8	93		SOFI-4D	93		STS-TV9	96	
SIS-8D	93		SOFI-5	93		STS-X5	96	
SIS-9	93		SOFI-6	93		STS-X6	97	
SIS-9D	93		SOL-1	93		STUV-1D	97	
SIX-1	184		SOP-1D	94		STUV-1I	97	
SIX-1KP	185		SOS-1D	94		STUV-2	97	
SIX-1P	184		SOS-2D	94		SUZU- 1D	186	
SIX-1P1	184		SOS-3	94		SUZU- 1I	186	
SIX-1P2	184		SOS-4D	94		SUZU- 2D	186	
SIX-2	184		SOS-5	94		SUZU- 2I	186	
SIX-2P	184		SPI-1	94		SUZU- 3I	186	
SIX-2P2	184		SPI-1D	94		SUZU- 4D	186	
SIX-3P	185		SQ-1	94		SUZU- 4DP	187	
SIX-3P1	185		SQ-2	94		SUZU- 4I	186	
SIX-3P2	185		SQ-3D	94		SUZU- 4IP	187	
SIX-4	184		SQ-4	94		SUZU- 5	187	
SIX-4P	184		SR-1I	97		SUZU- 5P	187	
SIX-5P	185		SR-2	97		SUZU- 6	187	
SJL-1	93		SR-3	97		SUZU- 7	187	
SKO-1	133		SR-4	97		SUZU- 7P	187	
SKO-1P	134		SR-5	97		SUZU- 8	187	
SKO-2	134		SSO-1	93		SUZU- 8P	187	
SKO-3I	134		SSO-2	93		SUZU- 9P	187	
SKO-3IP	134		ST-1I	95		SUZU-10	187	
SKO-4	134		ST-2	95		SUZU-10P	187	
SKO-5P	134		STA-1	94		SUZU-11D	187	
SKO-6	134		STA-1D	94		SUZU-11DP	188	
SKO-7	134		STA-2	95		SUZU-12DP	188	
SKO-8	134		STA-2D	95		SUZU-13DP	188	
SL-1	91		STA-3	95		SUZU-13P	188	
SLG- 1	90		STA-3D	95				
SLG- 2	90		STA-4	95		<b>T</b>		
SLG- 3	90		STA-4D	95		TAI-1	97	
SLG- 4	91		STA-5	95		TAL-1	97	
SLG- 5	91		STA-5D	95		TAL-1D	97	
SLG- 6	91		STF-1	97		TAL-2	97	
SLG- 7	91		STF-1D	97		TAL-3	98	
SLG- 8	91		STK-1	95		TAP-1P	188	
SLG- 9	91		STL-1D	94		TAP-2	188	
SLG-10	91		STL-2I	94				

TEXTO	PAG.	PAG.	TEXTO	PAG.	PAG.	TEXTO	PAG.	PAG.
TAY-1	98		TOK-23	101		TRI- 1I	102	
TE - 1D	98		TOK-24	101		TRI- 2D	102	
TE - 1I	98		TOK-25	100		TRI- 2I	102	
TE - 3	98		TOK-26	100		TRI- 3D	102	
TE - 4	98		TOK-27	100		TRI- 3I	102	
TE - 7D	98		TOK-28D	101		TRI- 4D	102	
TE - 8D	98		TOK-29D	101		TRI- 4I	102	
TE - 8DKT1	98		TOK-30	101		TRI- 5D	102	
TE - 8I	98		TOK-31	101		TRI- 5I	102	
TE - 9D	98		TOM-1D	101		TRI- 6D	102	
TE -10I	98		TOP-1	101		TRI- 6I	102	
TE -11D	99		TOV-1	101		TRI- 7D	102	
TE -23	99		TOV-2	101		TRI- 7I	102	
TE -T10	99		TOV-3	101		TRI- 8D	102	
TE -T10D	99		TOV-4	101		TRI- 8I	102	
TE -T60	99		TOV-5	102		TRI- 9D	102	
TE -T80	99		TOV-6	102		TRI- 9I	102	
TE -T80SC	99		TOV-7	102		TRI-10D	102	
TEC-2	98		TOYO- 2	188		TRI-10I	102	
TEM-D35	98		TOYO- 3	188		TRI-11D	102	
TEM-D55	98		TOYO- 3P	188		TRI-11I	102	
TEM-I35	98		TOYO- 4	189		TRI-12D	102	
TEM-I55	98		TOYO- 4P	189		TRI-12I	102	
TEU-1	188		TOYO- 5	189		TRI-13	102	
TH-1	99		TOYO- 5P	189		TRI-14	102	
TI-1	99		TOYO- 5P1	189		TRI-15	102	
TI-1D	99		TOYO- 6	189		TRI-16	103	
TIF-1D	99		TOYO- 8	189		TRI-17D	103	
TIF- 1D	99		TOYO- 8IP	189		TRI-18	103	
TIF- 2	99		TOYO- 8P	189		TRI-18D	103	
TIF- 2D	99		TOYO- 9	189		TRI-19	103	
TIF- 3	99		TOYO- 9P	189		TRI-19D	103	
TIF- 4	99		TOYO- 9P1	190		TRI-20	103	
TIF- 5	100		TOYO-10	190		TRL-1P	102	192
TIF- 6	100		TOYO-10P	190		TRV-1	102	
TIF- 7D	188		TOYO-10P1	190		TRV-1D	102	
TIF- 8D	100		TOYO-11	190		TST-1	103	
TIF- 9	100		TOYO-11P	190		TUL-1D	104	
TIF- 9D	100		TOYO-11P1	190		TUL-2D	104	
TIF-10	99		TOYO-12	190		TUS-1D	104	
TIF-11D	100		TOYO-12D	190		TUS-2D	104	
TIF-12D	100		TOYO-12P1	190		TV- 1D	103	
TIF-13	100		TOYO-13	190		TV- 2D	103	
TK-2D	98		TOYO-13P1	190		TV- 3D	103	
TK-2I	98		TOYO-14	189		TV- 4D	103	
TOK- 2	100		TOYO-14P	189		TV-11	103	
TOK- 2D	100		TOYO-15	190		TV-12	103	
TOK- 3	100		TOYO-15P	190		TV-13	103	
TOK- 3D	100		TOYO-16	190		TV-15D	103	
TOK- 4D	100		TOYO-16P	190		TV-16D	103	
TOK- 5D	100		TOYO-16P1	191		TV-17	104	
TOK- 6	100		TOYO-17	191		TV-17D	104	
TOK- 6D	100		TOYO-17P	191		TV-18D	104	
TOK- 7D	101		TOYO-18P	191		TV-19D	104	
TOK- 8	101		TOYO-19P	191		TV-20	104	
TOK- 9	101		TOYO-20D	191		TV-21	104	
TOK-10D	101		TOYO-22	191		TV-22	104	
TOK-11	101		TOYO-22D	191		TV-22D	104	
TOK-12	101		TOYO-23	191		TV-23	104	
TOK-13D	101		TOYO-23P	191		TV-23D	104	
TOK-14D	101		TOYO-24	191		TZ-1	104	
TOK-15	101		TOYO-25	191		TZ-1D	104	
TOK-16D	101		TOYO-26	192				
TOK-17D	101		TOYO-27	192		<b>U</b>		
TOK-18	101		TOYO-28P	192				
TOK-19	101		TOYO-29	192		U- 1D	107	
TOK-20	101		TOYO-K1	189		U- 1I	107	
TOK-21	101		TOYO-K1P	189		U- 2D	107	
TOK-22	101		TRI- 1D	102		U- 2I	107	

TEXTO	PAG.	PAG.	TEXTO	PAG.	PAG.	TEXTO	PAG.	PAG.
U- 3D	107		UCEM- 5D	105		UN-33D	106	
U- 3I	107		UCEM- 5I	105		UN-33I	106	
U- 4AD	107		UCEM- 7D	105		UN-34D	106	
U- 4AI	107		UCEM- 7I	105		UN-34I	106	
U- 4D	107		UCEM- 8D	105		UN-35D	106	
U- 4I	107		UCEM- 8DP	105		UN-35I	106	
U- 4JD	107		UCEM-12	104		UN-36D	106	
U- 4JI	107		UCEM-13D	105		UN-36I	106	
U- 4TD	108		UCEM-17D	105		UN-37D	106	
U- 4TI	108		UL-1	105		UN-37I	106	
U- 5AD	108		UL-2D	105		UN-38D	106	
U- 5AI	108		UL-3	105		UN-38I	106	
U- 5CD	108		UL-4	105		UN-39D	106	
U- 5CI	108		UMF-1	105		UN-39I	106	
U- 5D	108		UN- 1FS	106	192	UN-40D	106	
U- 5DD	108		UN- 2	106	192	UN-40I	106	
U- 5DI	108		UN- 3	106	192	UN-41D	106	
U- 5DSP	108		UN- 4	192		UN-41I	106	
U- 5ED	108		UN- 5D	106		UN-42D	106	
U- 5EI	108		UN- 6D	106		UN-42I	106	
U- 5FD	108		UN- 7D	106		UN-43D	106	
U- 5FI	108		UN- 7I	106		UN-43I	106	
U- 5I	108		UN- 8D	106		UN-44	106	192
U- 5JD	108		UN- 8I	106		UN-44D	106	192
U- 5JI	108		UN- 9D	107		UN-45D	107	
U- 5MD	108		UN- 9I	107		UN-46D	107	192
U- 5MI	108		UN-10D	107		UN-47	107	
U- 5PD	108		UN-10I	107		UN-FFE	106	192
U- 5PI	108		UN-11	107		UN-FK	107	192
U- 5TD	108		UN-12I	106		UN-FP	106	192
U- 5TI	108		UN-13D	106		UN-FR	106	192
U- 5VD	109		UN-13I	106		UN-FS	107	192
U- 5VI	109		UN-14D	106		UN-FT	192	
U- 5XD	109		UN-14I	106		UN-MRN	106	192
U- 5XI	109		UN-15D	106		UN-NC	192	
U- 5YD	109		UN-15I	106		UN-NG	106	192
U- 5YI	109		UN-16D	106		UN-NH	193	
U- 6D	109		UN-16I	106		UN-NHP	193	
U- 6I	109		UN-17D	106		UN-TF	192	
U- 7	109		UN-17I	106		URB-1	110	
U- 7D	109		UN-18D	106		URB-1D	110	
U- 8	109		UN-18I	106		URB-2	110	
U- 8D	109		UN-19D	106		URKO-1D	110	
U- 8PD	109		UN-19I	106		URKO-1I	110	
U- 8TD	109		UN-20D	106		URKO-2D	110	
U- 9	109		UN-20I	106		URKO-2I	110	
U- 9D	109		UN-21D	106		URKO-3D	110	
U-10D	109		UN-21I	106		URKO-3I	110	
U-10I	109		UN-22D	106		URKO-4	110	
U-13D	109		UN-22I	106				
U-13I	109		UN-23D	106		<b>V</b>		
U-14D	109		UN-23I	106				
U-14I	109		UN-24D	106		VA- 1	110	
U-15	110		UN-24I	106		VA- 2	111	
U-15D	110		UN-25D	106		VA- 3	111	193
U-16	110		UN-25I	106		VA- 3I	111	193
U-16D	110		UN-26D	106		VA- 4	111	
U-17D	110		UN-26I	106		VA- 4D	111	
U-18D	110		UN-27D	106		VA- 5	111	
U-19	110		UN-27I	106		VA- 6	193	
U-19D	110		UN-28I	106		VA- 6P	193	
U-21	110		UN-29D	106		VA- 7	193	
U-21D	110		UN-29I	106		VA- 8D	111	
UCEM- 1D	104		UN-30D	106		VA- 9D	111	
UCEM- 1I	104		UN-30I	106		VA-10	193	
UCEM- 2D	104		UN-31D	106		VA-11	113	
UCEM- 2I	104		UN-31I	106		VA-12D	111	
UCEM- 3	104		UN-32D	106		VA-13D	111	
UCEM- 4I	105		UN-32I	106		VA-13I	111	

TEXTO	PAG.	PAG.	TEXTO	PAG.	PAG.	TEXTO	PAG.	PAG.
VA-14D	111		VA-RB	111		VO -K	157	
VA-15	111		VA-RC	111		VO -L	157	
VA-16	193		VA-RD	111		VO -M	157	
VA-17P	193		VA-RDH	111		VO -MP	157	
VA-18	193		VA-RDM	111		VO -N	156	
VA-19	111		VA-RE	111		VO -NP	156	
VA-20	111		VA-RF	111		VO -R	157	
VA-21	111		VA-RG	111		VO -RP	157	
VA-22	111		VA-RH	111		VO -VA	157	
VA-23	111		VA-RHM	111		VO -VAP	157	
VA-24D	112		VA-RJ	111		VO -VB	156	
VA-24I	112		VA-RK	111		VO -VBP	156	
VA-25	112		VA-RL	111		VO -VBP1	157	
VA-26	112		VA-RM	111		VOL-1	194	
VA-27	112		VA-RN	111		VOL-1P	194	
VA-28	112		VA-ROK	111		VOL-2	194	
VA-29	112		VE-1D	114		VOL-2D	194	
VA-29D	112		VG-1D	115		VOL-3	194	
VA-30	112		VG-4D	114		VOL-4	194	
VA-31D	112		VG-4I	114		VOL-5P	194	
VA-32D	112		VG-5D	114		VV-K70	157	
VA-33D	112		VG-5I	114				
VA-34	193		VI- 1D	114		<b>W</b>		
VA-34P	193		VI- 1I	114		WA-1D	115	
VA-34P1	194		VI- 2D	114		WA-4D	115	
VA-35	112		VI- 2I	114		WA-4I	115	
VA-35D	112		VI- 4D	115		WA-5D	116	
VA-36	113		VI- 4DP	115		WA-5DP	116	
VA-37	113		VI- 4I	115		WA-5I	116	
VA-38	113		VI- 4IP	115		WA-5IP	116	
VA-39	113		VI- 5D	115		WAL-1D	116	
VA-40	113		VI- 6D	115		WAL-2D	116	
VA-41	113		VI- 7	114		WAS- 1	194	
VA-42	113		VI- 8	115		WAS- 2P	194	
VA-43	113		VI- 8D	115		WAS- 3	194	
VA-44	113		VI- 9D	114		WAS- 3P	194	
VA-45	113		VI-10	115		WAS- 4	194	
VA-46	113		VI-11	115		WAS- 4P	194	
VA-47	113		VI-11D	115		WAS- 5	195	
VA-48	113		VI-12	114		WAS- 5P	195	
VA-49	113		VIN-1D	114		WAS- 6	195	
VA-50	113		VLK-1	115		WAS- 6P	195	
VA-51	113		VLK-2	115		WAS- 7D	195	
VA-52	113		VND-1	114		WAS- 7I	195	
VA-53	113		VND-1D	114		WAS- 8	195	
VA-54	113		VND-2	114		WAS- 8D	195	
VA-55	113		VND-2D	114		WAS- 9	195	
VA-56	112		VND-3	114		WAS- 9D	195	
VA-57	113		VO -1	155		WAS-10DP	195	
VA-58	113		VO -2	156		WAS-10P	195	
VA-59	113		VO -2DP	156		WBS-1	116	
VA-60	113		VO -2DP1	156		WE-4D	116	
VA-61C1	194		VO -2KP	156		WE-4I	116	
VA-61C2	194		VO -2P	156		WE-5D	117	
VA-62	112		VO -2P1	156		WE-5I	117	
VA-62D	112		VO -3KP	156		WEB-1	116	
VA-70	113		VO -4KP	156		WEB-2	116	
VA-75D	110		VO -5P	156		WEB-3	116	
VA-DHP	111		VO -6D	156		WEI-1	116	
VA-LA	111		VO -7	137		WEI-2	116	
VA-LB	111		VO -8P	156		WEI-3	16	
VA-LC	111		VO -8P1	156		WEI-4	116	
VA-LD	111		VO -AH	156		WEI-5	116	
VA-LE	111		VO -AHP	156		WEI-6	116	
VA-LF	111		VO -FH	156		WES-1D	117	
VA-LG	111		VO -FHP	156		WIL- 1D	117	
VA-LH	111		VO -FHP1	157		WIL- 2D	117	
VA-LN	111		VO -HV	156		WIL- 3D	117	
VA-RA	111		VO -HVP	156				

TEXTO	PAG.	PAG.	TEXTO	PAG.	PAG.	TEXTO	PAG.	PAG.
WIL- 4D	117		YA-21D	195		YAMA-18I	197	
WIL- 5	117		YA-21I	195		YAMA-18IP	197	
WIL- 5D	117		YA-22D	119		YAMA-19D	197	
WIL- 7	117		YA-22I	119		YAMA-19DP	197	
WIL- 8	117		YA-23	120		YAMA-19I	197	
WIL- 9	117		YA-24D	120		YAMA-19IP	197	
WIL-10	117		YA-24I	120		YAMA-20D	197	
WIL-11	117		YA-25D	120		YAMA-20DP	197	
WIL-12	117		YA-25I	120		YAMA-20I	197	
WIL-13	117		YA-26I	119		YAMA-20IP	197	
WIL-14	117		YA-27	120		YAMA-21I	197	
WIL-15	117		YA-27D	120		YAMA-21IP	197	
WIL-16	118		YA-28	120		YAMA-22DP	197	
WIL-17D	118		YA-28D	120		YAMA-22IP	197	
WIL-18	117		YA-29	119		YAMA-23DP	197	
WIL-19D	117		YA-30	120		YAMA-23IP	197	
WIL-20	118		YA-31D	120		YAMA-24DP	197	
WIN-1D	118		YA-32D	118		YAMA-24IP	197	
WIN-1I	118		YA-33D	120		YAMA-25DP	197	
WIN-2D	118		YA-34D	120		YAMA-26	197	
WIN-3D	118		YA-36D	120		YAMA-26D	197	
WIN-4D	118		YA-37	120	196	YAMA-26DP	197	
WIN-5	118		YA-37D	120	196	YAMA-26P	197	
WIN-5D	118		YA-38D	120		YAMA-27	197	
WIN-6D	118		YA-39	119		YAMA-27D	197	
WIT-1	195		YA-39D	119		YAMA-27DP	198	
WM-1D	118		YA-46D	121		YAMA-27P	198	
WM-2D	118		YA-50	121		YAMA-28P	198	
WM-3D	118		YA-50D	121		YAMA-29P	198	
WM-4D	118		YA-51	121		YAMA-30P	198	
WST-1D	117		YA-51D	121		YAR-1	121	
WST-2D	117	195	YA-52D	121		YAR-2	121	
			YA-53	120		YET- 1	121	
			YA-53D	120		YET- 1D	121	
<b>Y</b>			YAMA- 1D	196		YET- 2	121	
YA- 1D	118		YAMA- 1I	196		YET- 2D	121	
YA- 1I	118		YAMA- 2D	196		YET- 3D	121	
YA- 2D	118		YAMA- 2I	196		YET- 4	121	
YA- 2I	118		YAMA- 3D	196		YET- 4D	121	
YA- 3D	118		YAMA- 3I	196		YET- 5	121	
YA- 3I	118		YAMA- 4D	196		YET- 5D	121	
YA- 5D	119		YAMA- 5D	196		YET- 6	121	
YA- 5I	119		YAMA- 5I	196		YET- 6D	121	
YA- 6D	119		YAMA- 6D	196		YET- 7	121	
YA- 6I	119		YAMA- 6I	196		YET- 7D	121	
YA- 7D	119		YAMA- 7D	196		YET- 8	121	
YA- 7I	119		YAMA- 7I	196		YET- 8D	121	
YA- 8D	119		YAMA- 8D	196		YET- 9	121	
YA- 8I	119		YAMA- 8I	196		YET- 9D	121	
YA- 9I	119		YAMA- 9D	196		YET-10	122	
YA-10	119		YAMA- 9I	196		YET-10D	122	
YA-10D	119		YAMA-10D	196		YET-11	122	
YA-11D	119		YAMA-10I	196		YET-11D	122	
YA-11I	119		YAMA-11D	196		YET-12	122	
YA-12D	119		YAMA-11I	196		YET-13	121	
YA-12I	119		YAMA-12D	196		YET-14	121	
YA-13D	119		YAMA-12I	196		YET-14D	121	
YA-13I	119		YAMA-13D	196		YET-15	121	
YA-14D	119		YAMA-13I	196		YET-16	121	
YA-14I	119		YAMA-14D	196		YU-1D	198	
YA-15D	119		YAMA-14I	196				
YA-15I	119		YAMA-15D	196		<b>Z</b>		
YA-16D	119		YAMA-15I	196		ZA- 1	122	198
YA-17D	119		YAMA-16D	196		ZA- 1P	122	198
YA-17I	119		YAMA-16I	196		ZA- 2P	198	
YA-18D	195		YAMA-17D	196		ZA- 3D	198	
YA-19D	195		YAMA-17I	196		ZA- 4DP	198	
YA-20D	195		YAMA-18D	197		ZA- 5P	198	
YA-20I	195		YAMA-18DP	197				

TEXTO	PAG.	PAG.	TEXTO	PAG.	PAG.	TEXTO	PAG.	PAG.
ZA- 6DP	198		ZE- 1D	56		ZE-10D	57	
ZA- 6DP1	198		ZE- 2	56		ZE-11D	57	
ZA- 7DP	198		ZE- 2D	56		ZE-K1	57	
ZA- 8P	198		ZE- 5D	57		ZE-K2	57	
ZA- 9P	199		ZE- 5I	57		ZE-K5	57	
ZA- 9P1	199		ZE- 6	56		ZE-K6	57	
ZA-10	199		ZE- 6D	56		ZE-N1	57	
ZA-12	122		ZE- 7D	57		ZEN-1D	122	
ZA-13.P	199		ZE- 8	57		ZI-1	199	
ZE- 1	56		ZE- 9D	56				

## LLAVES DE CIERRE

IXTEGO GILTZAK • SNAP LOCK KEY BLANKS • CLES DE BOUCHE D'EAU • DORNSSCHLÜESSEL • CHIAVI PER CAMINO

TEXTO	PAG.	TEXTO	PAG.	TEXTO	PAG.
500	203	505	203	510	204
501	203	506	203	511	204
502	203	507	203	512	204
503	203	508	203	513	204
504	203	509	203		

## LLAVES EN CRUZ

GURUTZE-GILTZAK • CRUCIFORM KEYS • CLES CRUCIFORMES • KREUZBARTSCHLÜESSEL • CHIAVI A CROCE

TEXTO	PAG.	TEXTO	PAG.	TEXTO	PAG.
<b>A</b>		FRI-1X	209	<b>P</b>	
AGD-1X	207	FRI-2X	209	PAP-1X	213
AGD-2X	207	<b>G</b>		PAP-2X	213
ALA-1X	207	GEA-1X	210	<b>R</b>	
<b>B</b>		<b>K</b>		RO-1X	212
BLU-1X	207	KFV-1X	210	<b>T</b>	
BRI-1X	207	KFV-2X	210	TUF-1X	213
BRI-2X	207	KFV-3X	210	TUF-2X	213
BRI-3X	207	KR- 1X	210	TUF-3X	213
BUR-1X	207	KR- 2X	210	<b>U</b>	
BUR-2X	207	KR- 3X	210	U-1X	214
BUR-3X	208	KR- 4X	210	YA-1X	214
BUR-4X	208	KR- 5X	211	YA-2X	214
BUR-5X	208	KR- 6X	211	YA-3X	214
<b>C</b>		KR- 7X	211	YA-4X	214
CCF- 1X	208	KR- 8X	211	YA-5X	214
CCF- 5X	208	KR- 9X	211	YA-6X	214
CCF- 8X	208	KR-10X	211	<b>Z</b>	
CCF- 9X	208	KR-11X	211	ZE-1X	214
CCF-10X	208	KR-12X	211	ZE-2X	214
CIF-1X	209	KR-13X	212	ZE-3X	215
CRC-1X	209	KR-14X	212	ZE-4X	215
<b>D</b>		KR-15X	212	ZE-5X	215
DEB-1X	209	KR-16X	212	ZE-6X	215
<b>E</b>		KR-17X	212	ZE-7X	215
DOL-1X	209	<b>M</b>		ZE-8X	215
<b>F</b>		MM-1X	212	ZE-9X	215
FM-1X	209	MOR-1X	212		
FM-2X	209	MOR-2X	213		
		<b>N</b>			
		NAB-1X	213		
		NEF-1X	213		

# LLAVES DE GORJA DE ACERO DULCE

ALTZAIRU GOZOZKO GORJA GILTZAK • MILD STEEL BIT AND DUBLE BIT KEYS • CLES A GORGES EN ACIER DOUX

• WEICHSTAHL CHUBBSCHLÜSSEL • CHIAVI A MAPPA DI ACCIAIO

TEXTO	PAG.	TEXTO	PAG.	TEXTO	PAG.
200G	219	605G	225	1244G	233
201G	219	606G	225	1245G	233
202G	219	607G	225	1246G	233
203G	219	608G	226	1247G	233
204G	219	609G	226	1248G	233
205G	219	610G	226	1249G	233
206G	219	611G	226	1250G	234
207G	220	612G	226	1251G	234
208G	220	613G	226	1252G	234
209G	220	614G	227	1253G	234
210G	220	615G	227	1254G	234
211G	220	616G	227	1255G	234
212G	221	618G	227	1256G	234
213G	221	619G	227	1600G	235
214G	221	620G	227	1601G	235
215G	221	622G	228	1602G	235
216G	221	623G	228	1603G	235
217G	221	624G	228	1604G	235
218G	222	625G	228	1605G	235
219G	222	626G	228	1606G	235
220G	222	1200G	229	1607G	235
221G	222	1201G	229	1608G	236
222G	222	1202G	229	1609G	236
223G	222	1203G	229	1610G	236
224G	222	1204G	229	1611G	236
225G	222	1205G	229	1612G	236
226G	223	1206G	229	1613G	236
227G	223	1207G	230	1614G	237
228G	223	1208G	230	1615G	237
229G	223	1209G	230	1616G	237
230G	223	1210G	230	1617G	237
231G	223	1211G	230	1618G	237
232G	223	1212G	231	1619G	237
233G	223	1213G	231	1620G	237
234G	224	1214G	231	1621G	238
235G	224	1215G	231	1622G	238
236G	224	1216G	231	1623G	238
237G	224	1217G	231	1624G	238
238G	224	1218G	232	1625G	238
239G	224	1219G	232	1626G	238
600G	225	1220G	232		
601G	225	1221G	232	<b>B</b>	
602G	225	1241G	232		
603G	225	1242G	232	BON-2G	224
604G	225	1243G	232	BON-3G	224

# LLAVES DE GORJA DE LATON

LETOIZKO GORJA GILTZAK • BRASS BIT AND DOUBLE BIT KEYS • CLES A GORGES EN LAITON

• MESSING CHUBBSCHLÜSSEL • CHIAVI A MAPPA DI OTTONE

TEXTO	PAG.	TEXTO	PAG.	TEXTO	PAG.
1G	241	AD-25	244	AS-2G	246
2G	241	AD-26	244	AS-3G	246
3G	241	AD-27	244	AS-4G	255
4G	241	AD-28	244	AS-5G	289
5G	241	AD-29	244	AS-6G/1	246
6G	241	AD-33T	287	AS-6G/2	247
7G	241	AD-44/1	244	ATR-1G	255
8G	241	AD-44/2	244	ATR-2G	255
11G	242	AD-44/3	244	ATR-2TG	256
12G	242	AD-44/4	244	AYP-1G	289
13G	242	AD-44/5	244		
14G	242	AD-44/6	244		
15G	242	AD-46	291		
16G	242	AD-47	291	<b>B</b>	
17G	242	ADPLE-1	245	BE-1G	256
19G	243	ADPLE-2	245	BE-2G	256
21G	243	ADPLE-3	245	BE-3G	256
23G	243	ADPLE-4	245	BE-4G	256
24G	243	AGA-1G	246	BE-5G	256
25G	243	AGA-2G	287	BE-6G	256
51G	285	AGA-3G	287	BE-7G	256
52G	285	AGA-4G	291	BMC-1G	256
52GPC	285	AGA-5G	287	BOD-1G	257
53G	285	AGA-6G	291	BOD-2G	257
54G	285	AGA-7G	291	BOD-3G	257
55G	285	AGA-8G	291	BOD-4G	247
56G	285	AGA-9G	291	BOD-5G	247
57G	285	ALE-1G	287	BOG-1G	257
66G	286	ANT-1G	255	BOX-1G	257
68G	286	ANT-2G	255	BRI-6L 1	247
72G	286	ANT-3G	255	BRI-6L 2	247
73G	286	ANT-4G	255	BRI-6L 7	247
74G	286	ANT-5G	255	BRI-6L 8	247
126H-60G	246	APEC-1G	292	BRI-6L11	247
126N-60G	246	APEC-2G	292	BRI-6L12	247
126PP-60G	246	ARC- 1G	287	BRI-6L17	247
		ARC- 2G	287	BRI-6L18	247
<b>A</b>		ARC- 3G	288	BRI-6L21	247
ABU-2G	287	ARC- 4G	288	BRI-6L22	247
AD- 1	243	ARC- 5G	288	BRI-6L29	247
AD- 2	243	ARC- 6G	288	BRI-6L30	247
AD- 3	243	ARC- 7G	288	BUR-1G	292
AD- 4	243	ARC- 8G	288		
AD- 5	243	ARC-10G	288	<b>C</b>	
AD- 6	243	ARC-11G	288	CAF-1G	257
AD- 7	243	ARC-12G	288	CAF-2G	257
AD- 8	243	ARC-13G	288	CER-1G	274
AD- 9	243	ARC-14G	288	CER-2G	274
AD-10	243	ARC-15G	288	CER-3G	274
AD-11	243	ARC-16G	288	CER-4G	274
AD-12	243	ARC-18PG	288	CHU-1G	247
AD-13	243	ARC-19PG	288	CHU-2G	247
AD-16	244	ARC-20PG	289	CHU-4G	259
AD-17	244	ARC-21PG	289	CHU-5G	259
AD-18	244	ARC-22PG	289	CI- 1G	259
AD-19	244	ARC-23PG	289	CI- 1PG	259
AD-20	244	ARC-24G	289	CI- 2G	259
AD-21	244	ARC-25G	289	CI- 3G	260
AD-23	244	ARC-26G	288	CI- 4G	260
AD-24	244	ARC-27PG	289	CI- 5PG	260
		AS-1G	246	CI- 6G	260

<b>TEXTO</b>	<b>PAG.</b>	<b>TEXTO</b>	<b>PAG.</b>	<b>TEXTO</b>	<b>PAG.</b>
CI- 6PG	260	ELZ-3G	248	GMG-2G	270
CI- 7TG	260	ELZ-4G	265	GPS-1G	270
CI- 8G	260	ELZ-5G	248	GPS-2G	270
CI- 9PG	261	ELZ-6G	248	GPZ-1G	249
CI-10G	260	ELZ-7G	265	GUR-1G	249
CI-12TG	260	ER-1G	248		
CLA-3G	261	ER-4G	248	<b>H</b>	
COR-1G	261	ERV-1G	265	HEN-1GP	250
CR- 1G	261	ERV-2G	265		
CR- 2G	261	ERV-3G	265	<b>I</b>	
CR- 3G	261	ERV-3G/A	293	IDM-1G	270
CR- 4G	261	ES-1G	248	IDM-2G	271
CR- 5G	262	EST- 1G	265	IDM-3G	271
CR- 7G	262	EST- 2G	265	IDM-4G	271
CR- 8G	262	EST- 3G	265	IDM-5G	271
CR- 9G	262	EST- 4G	266	IS-1G	271
CR-10G	262	EST- 5G	266	IS-2G	271
CR-11G	262	EST- 6G	266	IS-3G	271
CR-12G	262	EST- 7G	266	IS-4G	271
CR-13TG	262	EST-10G	266	IS-5G	272
CR-14G	262	EUT-1G	266	IT-1G	272
CRN-1G	261	EUT-2G	266	IT-2G	272
CRT- 1G	257	EUT-3G	266	IT-3G	272
CRT- 2G	258	EZ-1G	267		
CRT- 3G	258	EZ-2G	267	<b>J</b>	
CRT- 4G	258	EZ-3G	267	JW-20G	272
CRT- 6G	258	EZ-4G	267	JW-30G	272
CRT- 7G	258	EZ-5G	267	JW-40G	272
CRT- 8G	258	EZ-6G	267	JW-45G	272
CRT-10G	289	EZ-7G	267	JW-50G	273
CRT-11G	258	EZ-8G	267	JW-70G	273
CRT-12G	258			JW-90G	273
CRT-13G	259	<b>F</b>			
CRT-14G	259	FA-1G	249	<b>K</b>	
CRT-15G	259	FA-2G	249	KAS-1G	273
CRT-17G	259	FA-3G	249	KAS-2G	273
CRT-18G	259	FA-4G	249	KAS-3G	273
		FA-5G	249	KAS-4G	273
<b>D</b>		FA-6G	249	KAS-6G	273
DEB-12L	248	FA-7G	249	KRP-1G	274
DUP-1G	292	FAC-1G	267	KUR-1G	274
DV- 1G	263	FAC-2G	267		
DV- 2G	292	FAC-3G	267	<b>L</b>	
DV- 3G	263	FAC-4G	268	LAR-2G	289
DV- 4G	292	FCF-1G	268	LAR-3G	290
DV- 5G	263	FEB-1G	268	LAR-4G	250
DV- 6G	263	FEB-2G	268	LASB-1G	250
DV- 7G	263	FET-1G	268	LASB-2G	250
DV- 8G	263	FIC-200	270	LASB-3G	250
DV- 9G	263	FIC-401G	249	LASB-4G	250
DV-10G	263	FM- 1G	268	LIN-1G	250
DV-10G/A	292	FM- 2G	268	LIN-2G	274
DV-11G	292	FM- 3G	268	LIN-3G	274
DV-12G	264	FM- 4G	269		
DV-13G	264	FM- 5G	269	<b>M</b>	
DV-13G/A	293	FM- 6G	269	MAC-1G	293
DV-14G	264	FM- 7G	269	MAX-1G	293
DV-15G	264	FM- 8G	269	MAX-2G	293
DV-16G	264	FM-13G	269	MCM-1G	251
DV-17G	293	FM-14G	269	MCM-2G	275
DV-18G	264	FM-15G	269	MCM-3G	275
DV-19G	264	FM-16G	270	MCM-4G	251
		FM-17G	270	MCM-5G	275
<b>E</b>					
ELB-1G	264	<b>G</b>			
ELZ-1G	264	GED-1G	289		
ELZ-2G	248	GMG-1G	270		

TEXTO	PAG.	TEXTO	PAG.	TEXTO	PAG.
MOI-1G	275	PTN-14G	278	TUS-1G	283
MOI-2G	275	PTN-15G	278	TV- 1G	252
MOI-3G	275			TV- 2G	252
MOK-1G	251	<b>R</b>		TV- 3G	253
MT- 1G	275			TV- 5G	253
MT- 2G	275	REN-1G	251	TV- 7G	253
MT- 3G	276	REN-2G	251	TV- 8G	253
MT- 3PG	276	REVI-1G	279	TV- 9G	253
MT- 4G	276	REX-1G	252	TV-10G	253
MT- 5G	276	REX-2G	252	TV-11G	253
MT- 6G	276	RGL-1G	280	TV-12G	253
MT- 6PG	276	RUB-1G	280	TV-13G	253
MT- 8G	277	RUB-2G	280	TV-14G	253
MT- 8PG	277	RUB-3G	293	TV-15G	253
MT- 9G	277	RUB-4G	280	TV-16G	253
MT- 9PG	277	RUB-5G	280	TV-17G	253
MT-10G	276	RUB-6G	290	TV-18G	253
MT-10PG	276	RUE-2G	290	TV-19G	253
MT-11G	277			TV-20G	253
MT-14G	277	<b>S</b>		TV-21G	253
MT-15G	277			TV-22G	254
MT-16G	277	SAF-1G	280	TV-23G	254
MT-17PG	277	SAF-2G	280	TV-24G	254
		SAM-1G	280	TV-25G	254
<b>O</b>		SAM-2G	281	TV-26G	254
OMC-1G	277	SAM-4G	281	TV-27G	254
OR-0G	290	SDR-1G	282		
OR-1G	290	SDR-2G	282	<b>U</b>	
OR-2G	278	SDR-3G	282		
OR-3G	251	SEC-1G	281	UCEM-1G	254
OR-4G	290	SEC-2G	281	UCEM-2G	254
OR-5G	290	SEC-3G	281	UCEM-3G	254
OR-6G	251	SEC-4G	281	UN-1G	254
OST-1G	251	SEC-7G	281		
OST-2G	251	SER-1G	294	<b>V</b>	
		SIB-1G	294		
<b>P</b>		SIB-2G	282	VILL-1G	290
		SIB-3G	282		
PAT-1G	278	SIB-4G	282	<b>W</b>	
PR-1G	279	SIB-5G	282		
PR-2G	293	SRM-1G	281	WE-1G	283
PR-3G	279			WE-2G	284
PR-4G	279	<b>T</b>		WM-1G	254
PTN- 1G	278				
PTN- 2G	278	TE-1G	252	<b>Y</b>	
PTN- 3G	278	TE-2G	252		
PTN- 4G	278	TE-3G	252	YA-1G	284
PTN- 5G	278	TEC-1G	282	YA-2G	284
PTN- 6G	278	TOV-1G	283	YA-3G	284
PTN- 7G	278	TR-1G	283	YA-4G	284
PTN-11G	278	TSI-1G	283	YA-5G	254
PTN-13G	278	TTN-1G	283		
		TTN-2G	283		

## LLAVES DE GORJA DE ZAMAK

ZAMAKEZKO GORJA GILTZAK • ZAMAK FURNITURE KEYS • CLES POUR MEUBLES EN ZAMAK

• ZAMAK MÖBELSCHLÜSSEL • CHIAVI ARTISTICHE E PER MOBILI IN ZAMA

TEXTO	PAG.	TEXTO	PAG.	TEXTO	PAG.
<b>C</b>		<b>N</b>		NEF-2Z 7	297
CIS-803/1	297	NEF-2Z 1	297	NEF-2Z 8	297
CIS-803/2	297	NEF-2Z 2	297	NEF-2Z 9	297
CIS-803/3	297	NEF-2Z 3	297	NEF-2Z10	297
CIS-803/4	297	NEF-2Z 4	297		
CIS-803/5	297	NEF-2Z 5	297		
CIS-803/6	297	NEF-2Z 6	297		

## LLAVES ARTISTICAS Y DE ARMARIO EN LATON

LETOIZKO GILTZAK: ARMAIRUETARAKO ETA ARTISTIKOAK • BRASS FURNITURE KEYS • CLES POUR MEUBLES EN LAITON

• MESSING MÖBELSCHLÜSSEL • CHIAVI ARTISTICHE E PER MOBILI IN OTTONE

TEXTO	PAG.	TEXTO	PAG.	TEXTO	PAG.
<b>A</b>		C-3G(CV)	302	<b>L</b>	
A-0G	301	<b>D</b>		L-3G	303
A-0G(CV)	301	D-3G	302	L-3G(CV)	303
A-1G	301	D-3G(CV)	302	<b>N</b>	
A-1G(CV)	301	<b>E</b>		N-1G	304
A-1G/1	301	E-0G	302	N-1G NIQ	304
A-1G/2	301	E-0G(CV)	302	<b>U</b>	
A-1G/3	301	E-1G	302	U-1G	304
A-1G/4	301	E-1G(CV)	302	U-1G NIQ	304
A-1G/5	301	E-2G	303	<b>V</b>	
A-1G/6	301	E-2G(CV)	303	V-1G	304
A-2G	301	E-3G	303	V-1G(CV)	304
A-2G(CV)	301	E-3G(CV)	303	V-2G	304
A-2G/1	301	<b>H</b>		V-2G(CV)	304
A-3G	301	H-3G	303	V-3G	304
A-3G(CV)	301	H-3G(CV)	303	V-3G(CV)	304
A-4G	301	<b>I</b>		V-4G(CV)	304
A-5G	301	I-1G	303	V-5G(CV)	304
AA-1G	302	I-1G NIQ	303		
AA-1G(CV)	302	<b>J</b>			
AA-2G	302	J-1G(CV)	303		
AA-2G(CV)	302	J-2G(CV)	303		
AA-3G	302	J-3G	303		
AA-3G(CV)	302	J-3G(CV)	303		
<b>B</b>					
B-3G	302				
B-3G(CV)	302				
<b>C</b>					
C-3G	302				

## LLAVES ARTISTICAS Y DE ARMARIO EN ZAMAK

ZAMAKEZKO GILTZAK: ARMAIRUETARAKO ETA ARTISTIKOAK • ZAMAK FURNITURE KEYS • CLES POUR MEUBLES EN ZAMAK

• ZAMAK MÖBELSCHLÜSSEL • CHIAVI ARTISTICHE E PER MOBILI IN ZAMA

TEXTTO	PAG.	TEXTTO	PAG.
<b>A</b>		<b>E</b>	
A1(L)	307	E1(L)	307
A1(N)	307	E1(N)	307
<b>D</b>		<b>F</b>	
D1(L)	307	F1(L)	307
D1(N)	307	F1(N)	307

## LLAVES PLANAS

GILTZA ZAPALAK • ZAMAK FURNITURE KEYS • CLES POUR MEUBLES EN ZAMAK

• ZAMAK MÖBELSCHLÜSSEL • CHIAVI ARTISTICHE E PER MOBILI IN ZAMA

TEXTTO	PAG.	TEXTTO	PAG.
7-S	311	<b>D</b>	
26-M	311	DIE-1	311
<b>A</b>		<b>U</b>	
AC-9	311	URKO-4	311
AC-12	311	<b>Y</b>	
AC-14	311	YA-30	311
AC-15	311		

# INDICE GENERAL

AURKIBIDE OROKORRA • GENERAL INDEX • INDEX GENERALE • GESAMTVERZEICHNIS • INDICE GENERALE

MARCA • MARKA • MAIN • MARQUE • HAUPTMARKE • MARCA	PAG.	PAG.	PAG.	PAG.	PAG.	PAG.	PAG.	PAG.	PAG.	PAG.	PAG.	PAG.	PAG.	PAG.	PAG.	PAG.	PAG.	PAG.	PAG.	PAG.
45	1																			
126	246																			
303	1																			
333	1																			
<b>A</b>																				
A.M. BARAS	1																			
ABBES	67	162																		
ABC	1																			
ABLOY	2																			
ABSA	2	3	86	87	125	181	182													
ABT	115																			
ABUS	3	4	5	6	20	29	30	31	50	56	61	80	86	101	114	115	119	120	125	287
ACE	28																			
ADAMSRITE	6																			
ADEMCO	28	120	196																	
AEP	6																			
AGA	6	7	8	16	23	28	246	287	291											
ACB	8																			
ACC	8	207																		
AGE	8																			
ACUEDA	98																			
ACUIA	8																			
AGUT	8																			
AHRAM	8																			
AIZPUTE	9																			
AKIRA	121	122																		
AKS	125	148	149	150	151	155	156	157												
ALA	207																			
ALDRIDGE	9																			
ALE	9																			
ALEDAL	287																			
ALFA	7	50																		
ALIANCA	9																			
ALLGOOD	25																			
ALPHA	9	28	125																	
ALSO	62																			
ALTAY	9																			
ALUNORM	31																			
AM	77																			
AMERICAN MOTORS	17	62	126	127																
AMIG	9	10	11																	
ANA	212																			
ANCHOR	3	5	10																	
ANKE	22																			
ANKER	10	11																		
ANKERSLOT	10	69																		
ANTAR	11	87																		
ANTONIOLI	255																			
APEX	11																			
APRI	77																			
ARCU	11	287	288	289																
AREL	11																			
APES	292																			
ARFE	11	12	85	291	294															
ARMAN	137	142	143	194																
ARMOR	87	182																		
ARMSTRONG	4																			
ARNOU	24																			
AROUCA	12																			
ARREGUI	7	12	24																	

MARCA • MARKA • MAIN • MARQUE • HAUPTMARKE • MARCA	PAG.	PAG.	PAG.	PAG.	PAG.	PAG.	PAG.	PAG.	PAG.	PAG.	PAG.	PAG.	PAG.	PAG.	PAG.	PAG.	PAG.	PAG.	PAG.	PAG.
ARROW	12																			
ARSENEVSK	12																			
ARTEB	185																			
ASEC	9																			
ASHICO	12																			
ASIA	12	121	122																	
ASPA	36																			
ASSA	12	13	14	88	98	126	246	247	255	289										
ASTRAL	29	30																		
ATAL	67	68	111	162	163															
ATL	22																			
ATLAS	97																			
ATP	24																			
ATRA	59	255	256																	
AUMON	14	34																		
AUNO	255																			
AUTOBLOCK	185	186																		
AVA-CHUBB	28																			
AVANGARD	14																			
AXA	126																			
AXIS	30																			
AYPE	289																			
AZBE	14	15	118																	
AZKOYEN	16																			
AZU	126																			
<b>B</b>																				
B+D	16																			
BAB	16	33	87																	
BAGEM	1	16																		
BALTIKA	16																			
BANE SEKULIC	21																			
BANHAM	17																			
BARCZ	17																			
BARIER	17																			
BARRO	36																			
BASCO	17	126	127	161																
BASH	17																			
BASI	17																			
BASTA	17	18	73	173	174															
BATU	18	29	56																	
BAU	110																			
BELL	121	122																		
BENCO	98																			
BENDIX	119	120	196																	
BERAM	114																			
BERRY	19	26																		
BERTOLOTTI	99																			
BEST	18																			
BETA	18	256																		
BEY	18																			
BIBERING	18																			
BIELLE	18																			
BIFFAR	18	101																		
BILMA	18																			
BIRD	49	119																		
BKS	19	49	70	119	214															
BLAU	127	145																		
BLOCK	186																			
BLOCTOUT	20																			
BLOCUS	84	85	87																	
BLOSTER	183																			
BLUMA	207																			
BMC	256																			
BMH	297																			
BODA	19	25	26	247	257	281														
BOGATIR	257																			

	PAG.	PAG.	PAG.	PAG.	PAG.	PAG.	PAG.	PAG.	PAG.	PAG.	PAG.	PAG.	PAG.	PAG.	PAG.	PAG.	PAG.	PAG.	PAG.	PAG.
BOINATTI	224																			
BOMORO	19	114	127	177																
BORKEY	19	20																		
BOSCH	127	128	177																	
BOXAFE	257																			
BRABANTIA	31	76	130																	
BRAS	20																			
BRASIL	20																			
BRETER	122	199																		
BRICARD	4	20	21	29	65	70	90	207	247											
BRIGGS & STRATTON	17	127	128	130	138	139	140	141												
BRITAX	137	164																		
BRUMME	21	56	57																	
BSS	21																			
BTV	21	35	36	96	275															
BUFFO	4	5	125																	
BUGA	21																			
BULIT	3	62																		
BURG WACHTER	3	5	21	22	23	33	57	81	87	115	128	182	207	208	272	273	292			
BURGHOWT	98																			
BUS	23																			
BUVA	22	23																		
BY	23																			
BYP	58																			

**C**

C.A.R.S.	81																			
C.V.C.	11																			
CAB	23	119	120																	
CAF	257																			
CAMA	128																			
CAMBOA	31	209																		
CAP	24	84	85																	
CARAT	49	119																		
CARTERO	23																			
CAS CISMA	23	77	297																	
CASAS	7	23																		
CASELLAS	128																			
CASH BOX	24																			
CASI	91	137	138	148	149	150	153	155	156	157										
CASMA	25	27																		
CATERPILLAR	128																			
CATOR	88																			
CAVERS	15	24	94																	
CAYS	24	25	34	96																
CAZORLA	34																			
CC	98																			
CCF	208																			
CCL	33																			
CEM	70	71	128	129	137	138	163	164	172	192	193									
CEMA	25																			
CENTURION	15																			
CENTURY	25																			
CERRAMARC	25																			
CERUTTI	257	258	259	289																
CES	25	26	27																	
CESSNA	129																			
CF	49	278																		
CFP	117																			
CHANGE-O-MATIC	32																			
CHAVO	5	27	29	31																
CHELIABINSK	27																			
CHEYLOCK	27																			
CHC	50																			
CHICAGO	17	28	119	120	127	196														
CHRIST	36																			
CHRYSLER	129	130																		

MARCA • MARKA • MAIN • MARQUE • HAUPTMARKE • MARCA	PAG.	PAG.	PAG.	PAG.	PAG.	PAG.	PAG.	PAG.	PAG.	PAG.	PAG.	PAG.	PAG.	PAG.	PAG.	PAG.	PAG.	PAG.	PAG.	PAG.
CHUBB	28	247	259																	
CIB	49	82	84	85	104															
CIBC	49																			
CIBOX	22																			
CIEF	28																			
CIELS	28																			
CIFIAL	28	209																		
CILA GENTILI	29																			
CINA	12	29	40	92																
CISA	3	4	5	29	30	31	70	259	260	261										
CITY	24	49																		
CLASS	261																			
CLAUSOR	31	76	129	130	131	137	138	142	151	169	170	171	172	173	174	176	177	185	187	
CLEMSA	31																			
CLICK	131																			
CLUM	131																			
COBRA	131																			
CODEM	49																			
CODKEY	94																			
COFER	75																			
COLE HERSEE	119	120																		
COLOMENCA	7																			
COM	31																			
COMBA	26	64	100	132																
CORBIN	31	32	33	37	38	39	126	127	261											
CORNI	99	261																		
CORONA	33	57																		
CORSA	98																			
COTICO	34																			
COUILLET	86																			
CR	214	261	262																	
CRC	31	209																		
CROMODORA	183																			
CUBELLS	34																			
CVL	34																			
CWS	36																			
<b>D</b>																				
DACIA	132																			
DAD	34	35	36	48	96	112														
DAELIM	132																			
DAEWOO	132																			
DAIHATSU	132																			
DAMM	19																			
DARMIX	133																			
DATSUN	173	178	179																	
DAV	133																			
DC	87																			
DEBEAURAIN	53	87	105	209	248															
DECAYEUX	34	82	86																	
DEFA	34																			
DEHA	121	122																		
DEKABA	34	35																		
DELAPORTE	35																			
DELCA	35																			
DELTA	87																			
DERLOCHE	87																			
DESAL	22																			
DESPREZ	87																			
DEXTER	35	128																		
DIAMOND	35																			
DIEBOLD	35	311																		
DIFA	88																			
DIMITROVGRAD	35																			
DJC	98																			
DNS	54																			
DOBLE SAFE	70	72	163																	

DOBLINA	133																			
DOCO	33																			
DOM	31	35	36	37	38	39	78	96	97	133	137	155	186	194						
DOMINION LOCK	12	39																		
DOMUS	23	39	40	271																
DONNER	98																			
DOOR LOCK	209																			
DOUBLE CIRCLE	40																			
DUBOIS	67	133	162																	
DUPLEX	292																			
DURABLE	22																			
DURALOCK	40																			
DVERNIK	263	264	292	293																

**E**

EAG	40																			
EAGLE	54																			
EAO	38																			
ECHO	133																			
ECM	40																			
EFER	28																			
EIKO	40																			
ELBOR	264																			
ELCA	42	99																		
ELEPHANT	102																			
ELFIN	25																			
ELMO	17	127																		
ELZETT	25	40	41	248	264	265														
EMGE	87																			
EMHART	37	38	39	87	182															
EMKA	41																			
EMOH	127																			
ENA OQ	104																			
EPO	90																			
EQUIBATIR	87																			
ERA	41	248																		
EREVAN	265	293																		
ERINRUDE	181																			
ERMEX	98																			
ESA	41	248																		
ESAFE	28	35	36	75	96	98	99	105	108											
ESCO	5	29	31	32	98															
ESETY	265	266																		
ESLA	41																			
ESS	41																			
ESSENDIA	5	29	31																	
ESZ	60																			
ETAS	41																			
ETNA	23	83																		
EUREKA	42																			
EURO	34																			
EURO LOCKS	18	28	42	70	71	72	163	164												
EURONORM	31	32																		
EUROP	97																			
EUROPARTNER	32																			
EUROTEMPLE	266																			
EVERGOOD	42	93																		
EVVA	42	43																		
EXCEL	43																			
EXPRES	70																			
EZCURRA	43	91	267																	
EZSET	65																			

**F**

FAAB	133																			
FAB	43	44	53	133	134															

MARCA • MARKA • MAIN • MARQUE • HAUPTMARKE • MARCA	PAG.	PAG.	PAG.	PAG.	PAG.	PAG.	PAG.	PAG.	PAG.	PAG.	PAG.	PAG.	PAG.	PAG.	PAG.	PAG.	PAG.	PAG.	PAG.	PAG.	
FAC	6	23	44	45	96	99	267	268													
FACEF	268	271																			
FADE	56	86																			
FAICA	134																				
FAINER	45																				
FALCON	18	116																			
FAMA	45																				
FANA	21	45																			
FARMA	134																				
FAS	45																				
FAS - YALE	248	249																			
FASEM	18	45																			
FASTEX	172																				
FAVOUR	45																				
FB	7																				
FCV	45	64																			
FEB	9	28	62	83	125	268															
FECHADURA	46																				
FECOR	35	36	291																		
FEDERAL	46	50																			
FEFI	26																				
FEL	92																				
FEMSA	134																				
FERMABLOCK	81																				
FERMOD	34																				
FERONERIA	46																				
FETIS	268																				
FF	46	47																			
FH	297																				
FHUR	60																				
FIAM	209	214	268	269	270																
FIAT	135																				
FICHET	18	47	101	116	249	270															
FISAM	134																				
FIST	47	128	135	142	183																
FLAMBO	39	133																			
FLIETHER	64																				
FLIK	50																				
FLOHR	47																				
FLORA	47	127																			
FO	24	79																			
FONTAINE	47	48	87	110																	
FORCE	52																				
FORD	135	136	137	138																	
FORINDEX	87	182																			
FORT	12	28	48	57	120	127	196														
FORTE	48																				
FORTIS	48																				
FORTRESS	98																				
FOUR CIRCLE	121	122																			
FPB	83																				
FRAL	83																				
FREA	183																				
FRECOV	25																				
FRIPA	209																				
FROSER	2	86	125	181																	
FT	53																				
PTH	3	48	49	50	99																
FUHR	26																				
FULLEX	50																				
<b>G</b>																					
GABON	50																				
GAINSBOROUGH	70	98																			
GALLUS	50																				
GAMMA	80																				
GARI	7																				

GAS	138																		
GATO	50																		
GAZ	194																		
GBS	117																		
GBZ	50																		
GE GE	50	51																	
GEBA	19	51																	
GEBRO	33																		
GEDASA	289																		
GEFI	5	29	31																
GELBAU	98																		
GELBON	163																		
GEM	28																		
GEMINI	62																		
GEMM	65	66																	
GENERAL MOTORS	138	139	140	141															
GERA	51	210																	
GETE	5	29	31																
GEVY	35																		
CHE	141																		
GIBBONS	51																		
GIESCHE	26	64																	
GIMN	87																		
GIOBERT	131	141	142	143	144	183													
GIPIS	270																		
GIUSSANI	51																		
GLAZIEV	52																		
GLOBE	52	53																	
GLOSTAL	50																		
GMC	270																		
GOLD DOOR	52																		
GOLLOT	87																		
GOTZ	64																		
GOYAL	7																		
GPZ	249																		
GRAF	64																		
GRAYHILL	57																		
GRUNDMANN	50																		
CSA	23																		
GTV	5	29	31	53	60														
GUARD	53	56																	
GUARDIAN	23	46	249																
GUERVILLE R.	53																		
GUIDOTTI	87																		
GUTTTEL	3	5																	
GUTLER	92																		

### H

HÄFELE	25	35	36	53	54	67	162												
HAGA	54																		
HAIDE	121	122																	
HAMA	145																		
HANNO	25																		
HARKOV	54																		
HARLEY DAV.	145																		
HARLOC	54	98																	
HASLER	91																		
HB	54																		
HBC	76																		
HEAD	121	122																	
HECTOR	54																		
HEGO	31																		
HEKNA	35	36	39	54															
HELCO-KFV	210																		
HEMA	110																		
HEMY	22	121	122																
HENDERSON	54	250																	

MARCA • MARKA • MAIN • MARQUE • HAUPTMARKE • MARCA	PAG.	PAG.	PAG.	PAG.	PAG.	PAG.	PAG.	PAG.	PAG.	PAG.	PAG.	PAG.	PAG.	PAG.	PAG.	PAG.	PAG.	PAG.	PAG.	PAG.
HERACLES	50																			
HERMES	121	122																		
HERO	81																			
HERPE	98																			
HERSEE	17	127																		
HESTE	31																			
HEWY	22																			
HILLMANN	99																			
HINO	192																			
HK	127																			
HOHRMANN	19	26	36	50																
HONDA	145	146	147	148																
HOPPE	22																			
HORSE	54	55																		
HRC	81																			
HSA	64																			
HTV	92																			
HUDSON	55	148																		
HUF	135	137	148	149	150	151	152	153	154	155	156	157								
HUTRA	91																			
HUWIL	35	36	55	157																
HYUNDAI	157	158	159																	
<b>I</b>																				
IACAM	143																			
IBEAR	55																			
ICA	55																			
ICSA	55																			
IDEAL	36																			
IDEAL SECURITY	116																			
IDM	270	271																		
IFAM	15	49	55	56	58	96														
IPOS	98																			
ICS	56																			
IKON	33	56	57	214	215															
ILARGI	57																			
ILCO	57																			
ILLINOIS	17	28	57	120	127	196														
IMB	58																			
IMBAC	85																			
IMP	3	5																		
IMSA	153	159	160	183																
INCECA	58																			
INDAK	188																			
INDAUX	12																			
INGERSOLL	58																			
INLOC	20																			
INSTALL	98																			
INT	58																			
IR	58																			
ISEO	25	58	59	84	105	111	193	271	272											
ISKU	81																			
ISSERSTEDT	31																			
ISUZU	160																			
ITAL	272																			
ITEM	22																			
ITO	5	29	31	59																
IVANA	59																			
<b>J</b>																				
JARDI	59																			
JD	9	88	125																	
JET	3																			
JINLONG	59																			
JIP	60	84	85	87																
JIS	60	63																		

JJ	34
JL	49
JMP	3 5
JOMA	55 56 60
JOE	117
JOSTA	25
JOVI	7 60
JOWIL	60 61
JPM	3 29 61
JTF	61
JU JUNGINGER	61 68 112 163
JUGODENT	137
JUNGST	60
JUNIE	61
JUNKUNC	62
JUVEL	272 273
JUZU	62
JVAL	62

**K**

K+K	75
KABA	62
KALE	3 63
KALUCA	63
KAMAZ	160
KAP	63
KARDEX	25 87 182
KARO	49
KASSEL	273
KATE	92
KAWASAKI	160 161
KAWE	31 32 98 116
KAZAN	63 64
KEMEN	6 7 81
KENWORTH	161
KERBEROS	274
KESO	64
KEYA	2 3 125
KFV	64
KIA	161
KICHINEV	64
KIFER	6
KIFERM	64 67 68 86 129 162 163 180 181
KIMA	26
KIND	22 25
KIROVSMACH	64 65
KITTY	2
KLIT	111 193
KN	127
KNAPP	25
KOLB	127 135 137 138
KP	65
KRAMATORSK	65
KREMENCHUG	65
KREPISH	274
KRESTI	210 211 212
KROST	23
KRV	24
KUNERT	29
KURZEME	274
KWIKSET	65
KYMCO	161
KYR	91

**L**

LABOFA	51
--------	----

MARCA • MARKA • MAIN • MARQUE • HAUPTMARKE • MARCA	PAG.	PAG.	PAG.	PAG.	PAG.	PAG.	PAG.	PAG.	PAG.	PAG.	PAG.	PAG.	PAG.	PAG.	PAG.	PAG.	PAG.	PAG.	PAG.
LADA BAKONY	161	162																	
LAFONTE	65																		
LAGRANDE	57																		
LAMA	77	100																	
LAMPA	25																		
LANE	33																		
LAPERCHE	23	65	66	87	110														
LAPORTE	19	66	127	181															
LAR	250	289	290																
LAREDO	49	119																	
LARK	52	67																	
LAS	67	68	86	162															
LASBOLAGET	62	68	92	250															
LEFEBURU	28																		
LEGGE	68																		
LG	12																		
LINCE	9	68	69	125	205	274													
LINDE	127																		
LION	62																		
LIONA LIOX	87																		
LIPS	69	85																	
LISTA	36																		
LITTO	10	31	69	70															
LM	98																		
LMP	163																		
LOB	70	75																	
LOCK	70																		
LOCKSYS	94																		
LOCKWOOD	70																		
LOGO	70																		
LORI	54																		
LOTUS	121	122																	
LOWE & FLETCHER	28	42	70	71	72	73	163	164	165										
LUCKY	73																		
LUMA	73																		
LUME	51																		
LUXOR	98																		
LYF	73																		
<b>M</b>																			
M.LUNA	2	125																	
MACOR	293																		
MAFOR	87	212																	
MAGNETI MARELLI	142	183	185																
MARCADET	67	162																	
MARIANI	73																		
MARK	102																		
MARQUES	73																		
MARUTI	165																		
MASTER	32	73	74																
MASTERCRAFT	98																		
MATTEY	97																		
MAUSER	25																		
MAXIGARD	50																		
MAXIM	293																		
MAZDA	165	166	167																
MBB	26																		
MCL	74																		
MCM	74	75	76	251	275														
ME FA	76																		
MECALUX	6	35	36																
MECO	76																		
MELSMETALL	21	22	76																
MENOVA	36																		
MERCURY	131																		
MERIT LINDE	167																		
MERKUR	60																		

MARCA • MARKA • MAIN • MARQUE • HAUPTMARKE • MARCA	PAG.	PAG.	PAG.	PAG.	PAG.	PAG.	PAG.	PAG.	PAG.	PAG.	PAG.	PAG.	PAG.	PAG.	PAG.	PAG.	PAG.	PAG.	PAG.	PAG.			
MERMIER	31	33																					
MERONI	76	77																					
METAL	77																						
METALCASTELLI	54	85																					
METALCHIMEX	98																						
METALUX	77	98	110																				
METEOR	19	35	36	68	77	163																	
METIZ	77																						
METTEM	264																						
MG MONTI	77																						
MIAN	52																						
MIBRA	71	164																					
MICHEL SEAT	77	82																					
MIGNON	119																						
MILA	77	78																					
MILES	78																						
MING TAY	78																						
MINI MOLA	212																						
MIRAGLIO	183																						
MITSUBISHI	167	168	169																				
MIWA	78																						
MLM	35	36	78	87	97	182																	
MOBELLA	79																						
MODERN	110																						
MOFLEX	81																						
MOGILEV	79																						
MOIA	275																						
MON	79																						
MONACOR	9	125																					
MONDIAL	53	87																					
MONOBLOC	24	79																					
MOREAUX	36	38	87	116	212	213																	
MOSKVA	251																						
MOSKVITCH	169																						
MOSRENTGUEN	79																						
MOTTURA	79	275	276	277																			
MP PLODARI	79																						
MR	98																						
MST	23																						
MSV	80																						
MUKRA	31	32																					
MULTLOCK	80																						
<b>N</b>																							
NABOB	213																						
NB	5	29	31	47																			
ND	104	105																					
NEIMAN	127	129	137	138	142	143	148	149	150	155	157	169	170	171	172	173	174	175	176	177	184	185	193
NEMEF	25	26	31	87	182	213	297																
NEWMAN TONKS	98																						
NICO	49	64																					
NISSAN	178	179	180																				
NOBO	36	39	133																				
NORDWEST	47	91																					
NOVA	80	101																					
NOVOFERM	31																						
NUMIDIA	41	87																					
<b>O</b>																							
OAL	33	51																					
OCTAVO M.	80																						
ODA	10	28																					
OFTTA	80																						
OIAUS	8																						
OJMAR	25	80	81																				
OLIVA	81																						

MARCA • MARKA • MAIN • MARQUE • HAUPTMARKE • MARCA	PAG.	PAG.	PAG.	PAG.	PAG.	PAG.	PAG.	PAG.	PAG.	PAG.	PAG.	PAG.	PAG.	PAG.	PAG.	PAG.	PAG.	PAG.	PAG.	PAG.
OLIVETTI	81																			
OMA	81																			
OMEC	82	277																		
OMIV	18																			
OMR	77	82																		
ONIUM	107																			
ORBA	92																			
ORDO	67	82	162																	
ORENGO	7	251	278	290																
ORION	98																			
ORION NOVOX	82																			
ORO	82																			
ORONA	204																			
ORSHA	82																			
OSKO	60																			
OSTMARK	251																			
OTIS	56	57																		
<b>P</b>																				
P&C I.	82																			
PADO	82	83																		
PANTHER	60																			
PAPAIZ	83	213																		
PAS	85																			
PASSY	86																			
PASTORE	84	85																		
PATRONE	278																			
PAYKAN	99																			
PB	81																			
PC	18	62	83																	
PEBRA	149																			
PENT	105																			
PENZMASH	83	84																		
PEROHAUS	39	50	51	61	141															
PERRIER	53																			
PETERBORO	39																			
PETROZAVODSK	84																			
PFÄFFENHAIN	84																			
PGO	180																			
PH	105																			
PHILLIPS	19	20	84																	
PICARD	18	84																		
PICARDIE	50	100																		
PJ	67	86	129	162	180	181														
PK	67	162																		
PLUS	5																			
PM	87																			
POLAR	127																			
POLLAK	181																			
POLLUX	84																			
POS	127	181																		
POTENT	77	278	279																	
PP	34																			
PRAZIS	214																			
PREFER	81	84	85	279	293															
PREMI	77																			
PRESTA	19	127	181																	
PROAUTO	2	125																		
PROBAT	49																			
PROGRES	48																			
PROMO	84	85																		
PROTEC	24																			
PZ	19																			
<b>Q</b>																				
QCM	34	104																		

QCP 24

**R**

RADIAL 112 113  
 RAM 121 122  
 RAUCO 54  
 REDY 70  
 REGAL 85  
 REGENT 54  
 RENAG 251  
 RENZ 35 36 42 67 68 85 86 162 163  
 REVI 279  
 REX 86 252  
 RGM 86  
 RIAZIAN 86  
 RICOUARD 86  
 RIGA 86  
 RIGAL 280  
 RIL 86 311  
 RIPA 56 86  
 RITTAL 22  
 RIV 104  
 ROC 49 119  
 RONEO 6 87 114 182  
 RONIS 65 66 67 86 87 88 162 181 182 212  
 ROOL A DOOR 16  
 ROOTES 164 165  
 ROS 163  
 ROSS 129 182  
 ROTO 22  
 ROYAL 3 5 114 115 121 122  
 RS 81  
 RUBEN 280 290 293  
 RUE 290  
 RUFFINI 183  
 RUKA 35 36 111  
 RUKO 88 89  
 RUSSIA 89  
 RUSSWIN 89  
 RUTALCHI 7

**S**

SAAB 182 183  
 SABT 89  
 SADV 21 86 87 181 182  
 SAFE 144 159 160 183 185 280  
 SAM 89 280 281  
 SAMSONITE 89  
 SANCHUN 121 122  
 SANEL 87 182  
 SANPEUR 113  
 SANTIS 25 26  
 SANTOS 82 83  
 SANY 9 125  
 SARGENT 90  
 SATURN 90  
 SCHAFER 87 182  
 SCHARER 90  
 SCHLAGE 15 90 91  
 SCHLECHTENDAHL 91  
 SCHLEGEL 35 36  
 SCHRITT 57  
 SCHUCO 3 5 29 31 64  
 SCOVILL 15  
 SCUDO 8  
 SE 53 98

MARCA • MARKA • MAIN • MARQUE • HAUPTMARKE • MARCA	PAG.	PAG.	PAG.	PAG.	PAG.	PAG.	PAG.	PAG.	PAG.	PAG.	PAG.	PAG.	PAG.	PAG.	PAG.	PAG.	PAG.	PAG.	PAG.	PAG.
SEA	91																			
SECURE	94																			
SECUREMME	281																			
SECURITAL	91																			
SEEBURG	57																			
SEIMA	163																			
SELECT	91																			
SELIVANOVSK	91																			
SEMEL	60	96																		
SEN	64																			
SERMEC	281																			
SERRALLER	7	34	55	96	294															
SERRETA	92	311																		
SES	98																			
SESA	87																			
SEZAN	121	122																		
SHANGAI	92																			
SHAW	92																			
SHILUTE	92																			
SHOWA	90																			
SIAM	24	92																		
SIBI	282	294																		
SIDERAL	282																			
SIDLEEN	43																			
SIEBAU	26	100																		
SIL	45	93	108																	
SIMATIC	92																			
SIMECA	51	92																		
SIMPLEX	87	182	184	185	193															
SINJET	36																			
SIPEA	142	143	144	183	185															
SIS	92	93																		
SISO	23	81	93																	
SISPA	181	185	186																	
SJL	93																			
SKILMANN	32																			
SOFER	93																			
SOFI SONAFI	93																			
SOLER	93																			
SOLID	26																			
SOLOR	87																			
SOPRANO	94																			
SOS	24	50	94	98	212															
SPEEDAL	25	27																		
SPIDER	94																			
SQUIRE & S.	94																			
SS	26																			
STA LOCK	94																			
STAM	46																			
STANDARD	5	29	31																	
STAR	94	95																		
STARLET	95																			
STEELCASE	28	55	157																	
STEIGA	36																			
STEKLOMASH	95																			
STIQAM	23	105																		
STRAFOR	55	67	87	157	162	182														
STRATTEC	136																			
STREBOR	95	163	186																	
STREMLER	20	23	31	87	110															
STS	23	35	36	95	96	97	99	186												
STUMPF METALL	81	97																		
STUV	25	26	36	78	87	97														
STV	82																			
SUF	49																			
SUKI	47																			
SUL	31																			
SUREX	97																			

SURFINOR	47			
SUYOKA	6			
SUZUKI	186	187	188	
SWAN	121	122		
SWEDA	85			

**T**

TAITO	97			
TALLINN	97	98		
TANLOCKS	68			
TAP-AGIS	188			
TAS	18			
TAYLOR	98			
TAYMOR	98			
TECHNAL	98			
TECNO	107			
TECNOLAR	96			
TECNOR	47			
TECSESA	96	98	282	
TECUMSEH	188			
TEICOCIL	98	101		
TEKA	13	98		
TELFORD	71	164		
TEM	56	98		
TERCA	7			
TESA	58	98	99	252
TESIO	283			
TESTA	23			
TH	99			
THOMAS LAIDLAW	99			
THONE	31			
TIBBE	149	188		
TICINO	99			
TIEFENTHAL	40	53	60	
TIFON	99			
TITAN	65	99	100	188
TITANO	283			
TM	36			
TOK WINKHAUS	18	100	101	195
TOKAJ RIKA	140	188	189	190 191 192
TOMSK	101			
TOP	80	101		
TOVER	49	101	102	283
TOYOTA	188	189	190	191 192
TR	283			
TRAMA	183			
TRAVEX	102			
TRELOCK	100	101	102	111 192 195
TRI CIRCLE	40	102	103	
TRI STAR	103			
TRIO-VING	103	104	207	252 253 254
TRITON	26	60		
TROMER	75	101		
TRUMPH	99			
TSAG	104			
TUFF	213			
TULA	104			
TURSCHLOSS	18			
TUSHINO	104	283		
TUTIS	40			
TZAFRER	29	50	104	

**U**

UBE	148	149	150	155	156
UCEM	34	104	105	114	254
ULIANOVSK	105				

MARCA • MARKA • MAIN • MARQUE • HAUPTMARKE • MARCA	PAG.	PAG.	PAG.	PAG.	PAG.	PAG.	PAG.	PAG.	PAG.	PAG.	PAG.	PAG.	PAG.	PAG.	PAG.	PAG.	PAG.	PAG.	PAG.	PAG.
ULTRA	71	72	164																	
UMF	105																			
UNIFOR	84																			
UNION	70	71	106	107	163	164	186	192	193	254										
UNIPART	195																			
UNIVERSAL	107	108	109	110	214															
URBIS	110																			
URKO	110	311																		
US	61																			
UTZ	71	92	164																	
<b>V</b>																				
VACHETTE	65	66	99	100	110	111	112	113	114	184	193	194	297							
VAGO	85																			
VALEO	176	191																		
VARIOS	113	114																		
VAUGHN	92																			
VDO	151																			
VEGA	11	87	114																	
VELO	121	122																		
VENDI	114																			
VENLOCK	98																			
VERSCO	31																			
VEGFVILLATORE	114																			
VIDMAR	91																			
VIKI	36																			
VILLFER	290																			
VINCO	111	112																		
VING	114																			
VIP	24																			
VIRO	2	114	115																	
VISO	121	122																		
VISONIC	9	125																		
VOKO	25	60																		
VOLGA	194																			
VOLGOGRAD	115																			
VOLKOVYSK	115																			
<b>W</b>																				
WALE	118																			
WALLY	115	116																		
WALRUS	116																			
WASO	25	127	137	178	179	194	195													
WEBER	116																			
WEBSTER	116																			
WECO	19	25	116	119	141															
WEISER	116																			
WELKA	116	117	283	284																
WEPA	60																			
WESCO	127																			
WESLOCK	117																			
WEST LOCK	117	195																		
WIGRO	117																			
WILKA	117	118																		
WILLENHALL	51																			
WILMOT BREEDEN	165																			
WINFIELD	121	122																		
WINKHAUS	118																			
WINNER	50	53																		
WITTE	148	149	150	155	156	157	195													
WMS	118	254																		
WOC	49	119																		
WSM	22																			

**Y**

YAC	87	182																		
YALE	17	19	49	92	118	119	120	121	127	129	130	195	196	214	254	284	311			
YALTRES	19	20	49																	
YAMAHA	196	197	198																	
YANEDIS	41																			
YARDENI	121																			
YEMAR	99	105																		
YETI	70	75	121	122																
YMOS	137	141	148	149	150	151	152	153	154	155	175	182	183							
YUGO	198																			
YVEL	86	133																		

**Z**

ZADI	122	198	199																	
ZAIN	14	15																		
ZANI	55																			
ZAZ	194																			
ZECE	31																			
ZEISS IKON	214	215																		
ZENI	24	122																		
ZENICA	24																			
ZENITH	24	92																		
ZIL	160	199																		

# AUTOMOVIL / CAMIONETA

AUTOMOBILA/KAMIONETA • CAR/PICK-UP TRUCKS • VOITURE/CAMIONNETTE • AUTO/KLEINTRANSPORTER • AUTO/CAMIONCINO

MARCA • MARKA MAIN • MARQUE HAUPTMARKE • MARCA	PAG.	PAG.	PAG.	PAG.	PAG.	PAG.
<b>A</b>						
ABT	315					
ACM	315					
ACURA (HONDA)	315					
ALFA ROMEO	315	316	317	318		
AMERICAN MOTORS	318	319				
ARO DACIA	319					
ASTON MARTIN	319					
AUDI	319	320				
AUSTIN	320					
AUTOBIANCHI	320	321				
<b>B</b>						
BEDFORD	321					
BENTLEY	321					
BERTONE	321	322				
BMA	322					
BMW	322					
<b>C</b>						
CARBODIES	322					
CITROEN	322	323	324	325		
CHRYSLER	325	326				
CHRYSLER (DODGE)	326	327				
CHRYSLER (EAGLE)	327	328				
CHRYSLER (PLYMOUTH)	328					
<b>D</b>						
DAEWOO	328	329				
DAF	329					
DAIHATSU	329	330				
DAIMLER	330					
DE LOREAN	330					
DELTA MOTOR	330					
DISALCAR	330					
<b>E</b>						
EBRO	330					
<b>F</b>						
FERRARI	330	331				
FIAT	331	332	333	334	335	336
FIAT IVECO	336	337				
FIAT (ARGENTINA)	337	338				
FIAT (BRASIL)	338					
FIAT (TURQUIA)	338	339				
FORD	339	340	341			
FORD (ARGENTINA)	341	342				
FORD (AUSTRALIA)	342					
FORD (BRASIL)	342	343				
FORD (SOUTH AFRICA)	343					
FORD (USA)	343	344				
FORD (USA) (LINCOLN)	344					
FORD (USA) (MERCURY)	344	345				
FREIGHTLINER	345					

MARCA • MARKA MAIN • MARQUE HAUPTMARKE • MARCA	PAG.	PAG.	PAG.	PAG.	PAG.	PAG.
<b>G</b>						
GM (BUICK)	345	346	347			
GM (CADILLAC)	347	348	349			
GM (CHEVROLET BRA.)	349	350				
GM (CHEVROLET)	350	351	352	353		
GM (GEO)	353					
GM (GMC)	353	354				
GM (OLDS MOBILE)	354	355	356			
GM (PONTIAC)	356	357	358			
GM (SATURN)	358					
<b>H</b>						
HAMOMAG HENSCHEL	358					
HOLDEN	358	359				
HONDA	359	360				
HYUNDAI	360	361				
<b>I</b>						
INFINITI (NISSAN)	361					
INNOCENTI	361	362				
INTER. HARVESTER	362					
IRMSCHER	362					
ISUZU	362					
<b>J</b>						
JAGUAR	362	363				
JEEP	363	364				
JENSEN	364					
<b>K</b>						
KENWORTH	364					
KIA	364					
<b>L</b>						
LA FORZA	364					
LADA VAZ	364	365				
LAMBORGHINI	365					
LANCIA	365	366				
LAND-RANGE ROVER	366	367				
LEXUS (TOYOTA)	367					
LOTUS	367					
<b>M</b>						
MACK	367					
MARUTI	367					
MASERATI	367	368				
MAZDA	368	369	370	371		
MERCEDES	371	372	373			
MG	373					
MITSUBISHI	373	374	375			
MOSKVITCH	375					
<b>N</b>						
NISSAN	375	376	377			

MARCA • MARKA MAIN • MARQUE HAUPTMARKE • MARCA	PAG.	PAG.	PAG.	PAG.	PAG.	PAG.
NISSAN (AUSTRALIA)	377					
NISSAN (USA)	377	378				
NSU	378					
<b>O</b>						
OM IVECO	378	379				
OPEL-VAUXHALL	379	380	381			
<b>P</b>						
PEUGEOT	381	382	383			
PEUGEOT (ARGEN.)	383	384				
PIAGGIO	384					
PORSCHE	384					
PREMIER	384					
<b>R</b>						
RAYTON FISSORE	384					
RENAULT	384	385	386	387		
RENAULT SAVIEM	387	388				
RENAULT (ARGEN.)	389					
ROLLS ROYCE	389					
ROVER	389	390	391	392		
<b>S</b>						
SAAB	392					
SEAT	392	393				
SKODA	393	394				
SSANGYONG	394					
STERLING	394					
STEYR-PUCH	394					
SUBARU	395					
SULKY	396					

MARCA • MARKA MAIN • MARQUE HAUPTMARKE • MARCA	PAG.	PAG.	PAG.	PAG.	PAG.	PAG.
SUNBEAM	396					
SUZUKI	396	397				
<b>T</b>						
TALBOT SIMCA	397	398				
TOYOTA	398	399	400	401		
TRABANT	401					
TRIUMPH	401					
<b>U</b>						
UAZ	401	402				
<b>V</b>						
VAUXHALL	402					
VOLGA	402	403				
VOLKSWAGEN	403	404	405			
VOLKSWAGEN (ARGEN.)	405					
VOLKSWAGEN (BRASIL)	405	406				
VOLKSWAGEN (CHINA)	406	407				
VOLKSWAGEN (MEXICO)	407					
VOLVO	407	408				
<b>W</b>						
WARTBURG	408					
<b>Y</b>						
YUGO-ZASTAVA	408	409				
<b>Z</b>						
ZAZ	409					

## CAMION

KAMIOIA • TRUCKS • CAMION • LKW • CAMION

MARCA • MARKA MAIN • MARQUE HAUPTMARKE • MARCA	PAG.	PAG.	PAG.	PAG.
<b>A</b>				
ASTRA	413			
<b>B</b>				
BEDFORD	413			
BROCKWAY	413			
<b>D</b>				
DAF	413	414		
DIAMOND REO	414			
<b>F</b>				
FIAT IVECO	414	415	416	417
FORD	417			
FORD (USA)	417			
FREIGHTLINER	417			

MARCA • MARKA MAIN • MARQUE HAUPTMARKE • MARCA	PAG.	PAG.	PAG.	PAG.
<b>G</b>				
GM (CHEVROLET)	417			
GM (GMC)	417	418		
<b>H</b>				
HINO	418			
<b>I</b>				
ISUZU	418			
<b>K</b>				
KENWORTH	418			
<b>M</b>				
MACK	418			

MARCA • MARKA MAIN • MARQUE HAUPTMARKE • MARCA	PAG.	PAG.	PAG.	PAG.
MAGIRUS DEUTZ	418			
MAN	418	419		
MERCEDES (ARGENTINA)	419			
MITSUBISHI	419			
<b>N</b>				
NISSAN	419			
<b>P</b>				
PEGASO	419	420		
PIAGGIO	420			
<b>R</b>				
RENAULT SAVIEM	420	421		
ROVER	421			

MARCA • MARKA MAIN • MARQUE HAUPTMARKE • MARCA	PAG.	PAG.	PAG.	PAG.
<b>S</b>				
SCANIA	422			
STEYR PUCH	422			
<b>T</b>				
TRUCK (USA)	422			
<b>V</b>				
VOLKSWAGEN	422			
VOLVO	422	423		
<b>W</b>				
WHITE	423			

## MOTO

### MOTORRA • MOTOR • MOTO • MOTO • MOTO

MARCA • MARKA MAIN • MARQUE HAUPTMARKE • MARCA	PAG.	PAG.	PAG.	PAG.	PAG.	PAG.	PAG.	PAG.
<b>A</b>								
APRILIA	427	428						
ATALA	428							
<b>B</b>								
BENELLI	428							
BETA	428	429						
BICICLETTA-CYCLES	429							
BIMOTA	429							
BMA	429							
BMW	429	430						
<b>C</b>								
CAGIVA	430	431	432					
CIMATTI	432							
<b>D</b>								
DEMM	432							
DERBY	432							
DKM-HERCULES	432							
DUCATI	432	433	434					
<b>F</b>								
FANTIC MOTOR	434	435						
<b>G</b>								
GARELLI	435	436						
GILERA	436	437						
<b>H</b>								
HARLEY DAVIDSON	437							
HERCULES	437							
HONDA	437	438	439	440	441	442	443	444

MARCA • MARKA MAIN • MARQUE HAUPTMARKE • MARCA	PAG.	PAG.	PAG.	PAG.	PAG.	PAG.	PAG.	PAG.
<b>I</b>								
ITALJET	444							
<b>K</b>								
KAWASAKI	444	445	446	447				
KTM	447	448						
KYMCO	448							
<b>L</b>								
LAMBRETTA	448							
LAVERDA	448							
LINCE	448							
<b>M</b>								
MAICO	448	449						
MALAGUTI	449							
MALANCA	449	450						
MBK	450							
MBM	450							
MONTESA	450							
MORINI FRANCO	450							
MOTO GUZZI	450	451	452					
MOTO MORINI	452	453						
MOTOBECANE	453							
MOTOBI	453							
MOTRON	453							
MV AUGUSTA	453							
MZ	453							
<b>N</b>								
NORTON	453							
<b>O</b>								
OMC	454							
OSSA	454							

MARCA • MARKA MAIN • MARQUE HAUPTMARKE • MARCA	PAG.	PAG.	PAG.	PAG.	PAG.	PAG.	PAG.	PAG.
<b>P</b>								
PERIPOLI	454							
PEUGEOT	454	455						
PGO	455							
PIAGGIO	455	456						
<b>R</b>								
RALEIGH	456							
RIZZATO	456	457						

MARCA • MARKA MAIN • MARQUE HAUPTMARKE • MARCA	PAG.	PAG.	PAG.	PAG.	PAG.	PAG.	PAG.	PAG.
<b>S</b>								
SULKI	457							
SUZUKI	457	458	459					
SWM	459	460						
<b>T</b>								
TESTI	460							
TRIUMPH	460							
<b>Y</b>								
YAMAHA	460	461	462	463	464	465		

## ALARMAS - AVIÓN - BICICLETA - CARAVANA - TAPÓN DE GASOLINA - MOTOR MARINO - PORTA ESQUIS - VARIOS

ALARMAK - HEGAZKINA - BIZIKLETA - KARABANA - GASOLINA TAPOIA - ITSAS MOTORRA - ESKI-EUSKARRIA - BESTE ZENBAIT •

ALARM - AIRPLAN - BICYCLE - CARAVANS - PETROL CAP - BOAT ENGINES - SKI HOLDER - OTHER •

ALARME - AVION - BICYCLETTE - CARAVANE - BOUCHON RESERVOIR - MOTEUR DE BATEAU - PORTE SKI - VARIOS •

ALARM - FLUGZEUGE - FAHRRADER - WOHNWAGEN - BENZINTANKVERSCHLUSS - SCHIFFSMOTOREN - SKITRAGER - VARIOS •

ALARME - AEREI - BICYCLETTE - CARAVAN - TAPPO BENZINA - MOTORI MARINI - PORTASCI - ALTRI

MARCA • MARKA MAIN • MARQUE HAUPTMARKE • MARCA	PAG.
ALARMA	469
AVION	469
BICICLETA	469
CARAVANA	469
CARRETILLA ELEVADORA	469
CORTA CESPED	469

MARCA • MARKA MAIN • MARQUE HAUPTMARKE • MARCA	PAG.
ESCAVADORA	470
MOTOR MARINO	470
PORTA ESQUIS	470
TAPON DE GASOLINA	470
TRACTOR	470



Tél. 04 73 84 84 94

# JMA

**LLAVES PLANAS PARA CERRADURAS  
DE CILINDRO**

**SARRAILA ZILINDRIKOTARAKO  
GILTZA ZAPALAK**









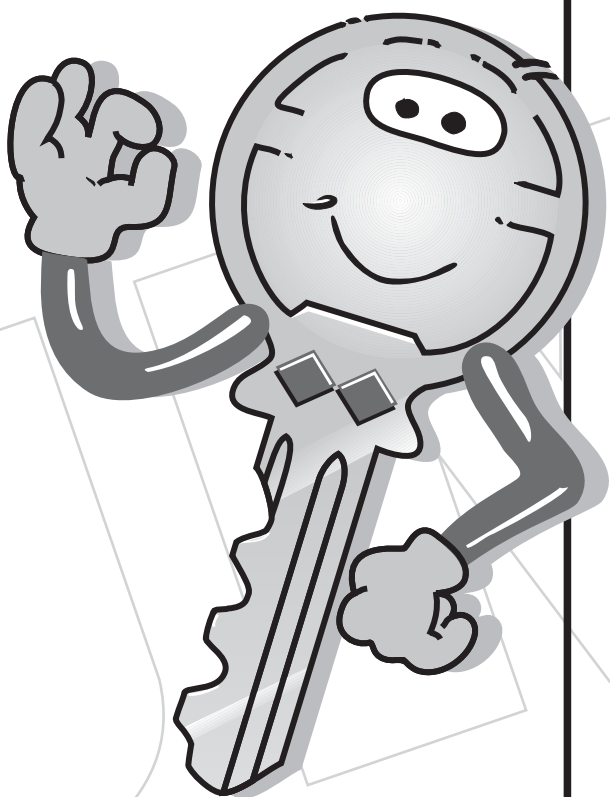

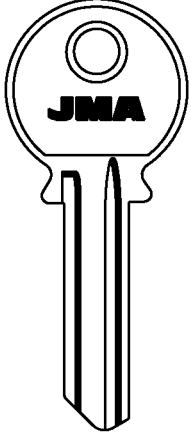
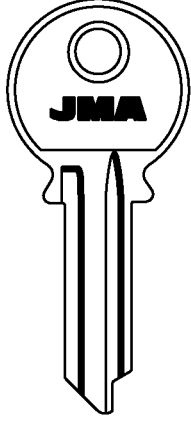
**CYLINDER KEYS**

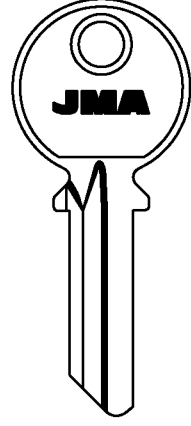
**CLÉS POUR CYLINDRES**

**ZYLINDERSCHIÜSSEL**

**CHIAVI PER SERRATURE A CILINDRO**



<b>PARA:</b> <b>FOR:</b>	45	303	333
			
			
45-1	45-1D	45-2	45-2D
			
		303-1	303-1D
			
			333-1D

**PARA-FOR:**







45 (RUS)



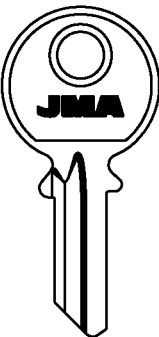
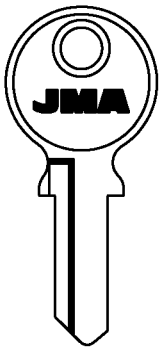
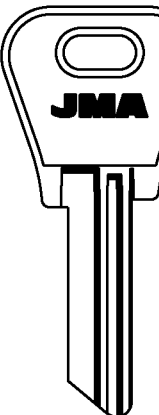
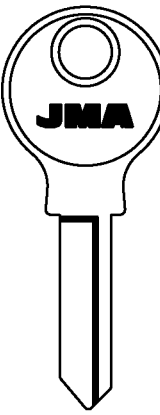

303 (RC)

333 (IL)

A.M. BARAS  
(GB)

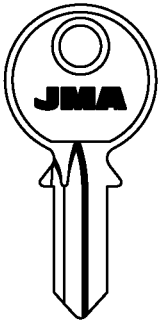
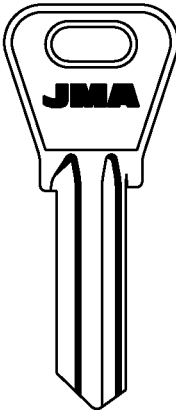
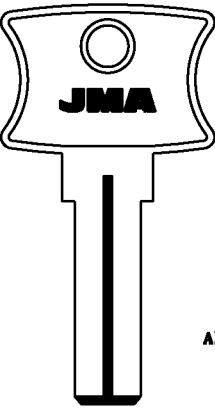
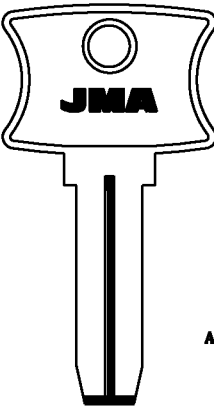
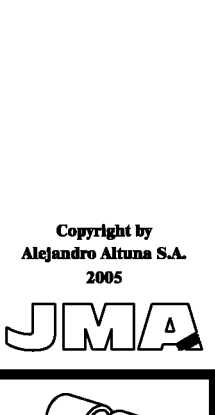
ABC (E)

<b>PARA:</b> <b>FOR:</b>	333	A.M. BARAS	ABC	
				
				
333-2D	AMB-1	AMB-1D	11A ABC-1	N ABC-2
			BAGEM	

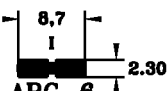
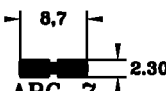
<b>PARA:</b> <b>FOR:</b>	ABC			
				
				
B2 ABC-3D	A1 ABC-5I	A2 ABC-5D	8,7 I ABC-6 2.30	8,7 I ABC-7 2.30
	BAGEM		BAGEM	BAGEM

Copyright by  
Alejandro Altuna S.A.  
2005

**JMA**

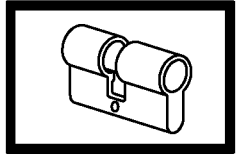

**1**

**PARA-FOR:**

**ABLOY (SF)**

**ABSA (E)**

**PARA: FOR: ABLOY**

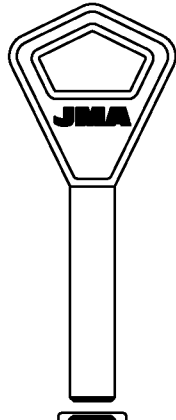

LAT.  
ACE.



0 AL 9  
ABL-1

KITTY-VIRO

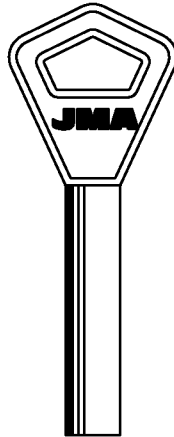

LAT.

ABL-2

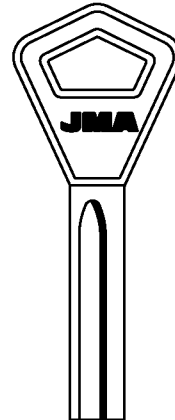

LAT.

C

ABL-3

ABL-4

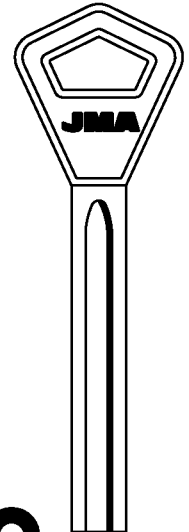

LAT.

ABL-5

**PARA: FOR: ABSA**

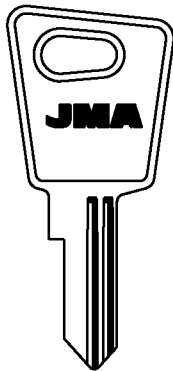

6  
AB-1I

7  
AB-2I

M.LUNA

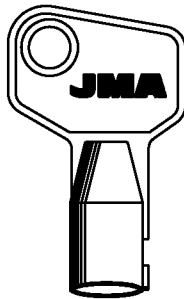

ZAM.

5  
AB-1D

AB-1T

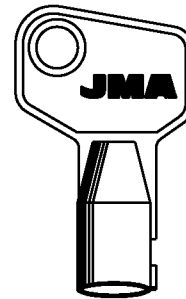

ZAM.

1  
6  
1  
AB-2T

AB-2T

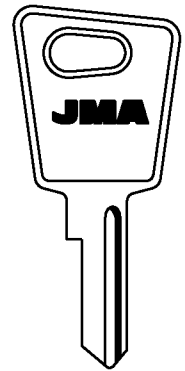

80  
AB-3I

M.LUNA

**PARA: FOR: ABSA**

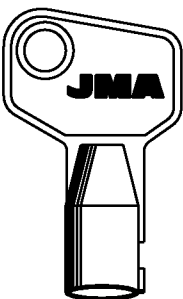

ZAM.

7  
1  
AB-3T

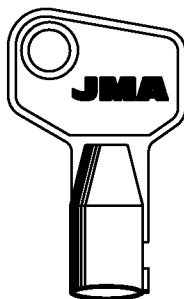

ZAM.

1.45  
6,1  
1  
AB-4T

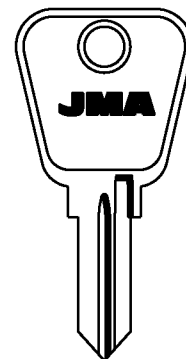

14  
AB-5I

13  
AB-5D

FROSER

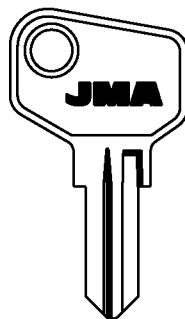

15  
AB-6I  
PROAUTO

14  
AB-8I

AB-6D

13  
AB-8D

FROSER-KEYA

Copyright by  
Alejandro Altuna S.A.  
2005

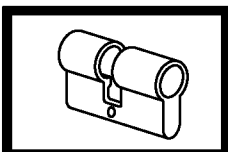

**JMA**



**2**

**PARA:**  
**FOR:**

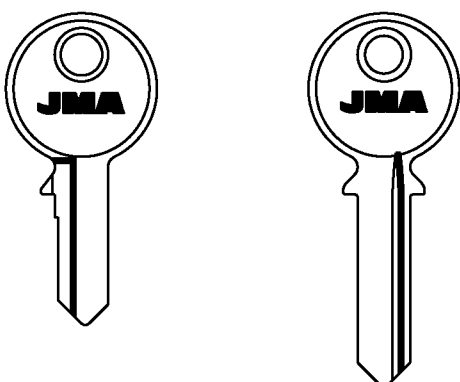







**ABSA**

**KEYA**

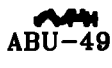
**PARA:**  
**FOR:**

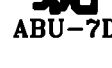
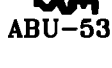
**ABUS**

**CISA-JPM-SCHUCO**











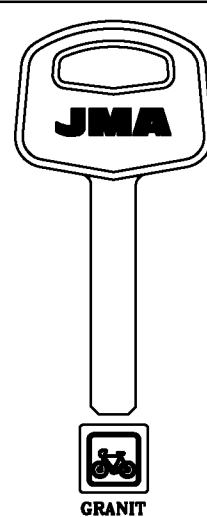

**PARA-FOR:**

**ABSA (E)**

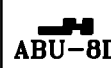
**ABUS (D)**

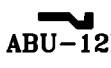
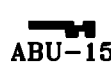
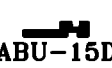
**PARA:**  
**FOR:**

**ABUS**











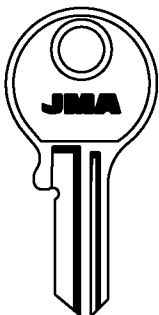

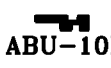
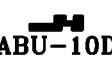









**ANCHOR-JET-JMP-KALE**

**ANCHOR-FTH-IMP**

**PARA:**  
**FOR:**

**ABUS**











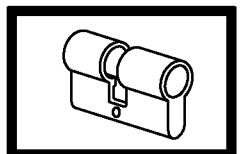

**CISA**

**ANCHOR-BURG**  
**GUITTEL-IMP-ROYAL**

Copyright by  
Alejandro Altuna S.A.  
2005

**JMA**



**3**

**PARA-FOR:**

**PARA:  
FOR:**

**ABUS**

**ABUS (D)**

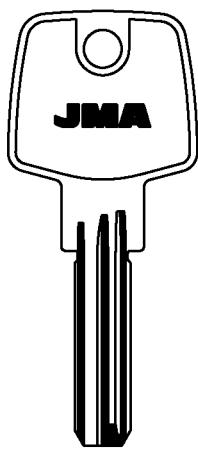

7.35  
AAL  
I  
2.35  
**ABU-16<sup>1</sup>**  
EXTRA CLASSE  
CISA-BRICARD

LAT.

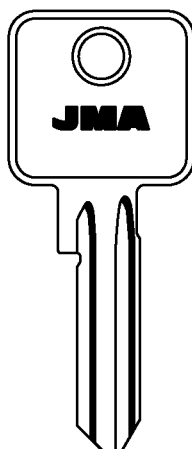

**ABU-17** **ABU-17D**  
**ABU-48**

CISA

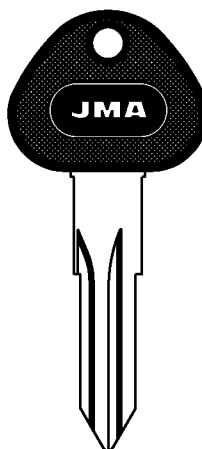

Z71....1-1043  
Z72....1-1043  
**ABU-18.P**

BUFFO

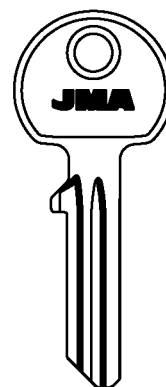

Z71....1-1043  
Z72....1-1043  
**ABU-19D**

BUFFO

**PARA:  
FOR:**

**ABUS**

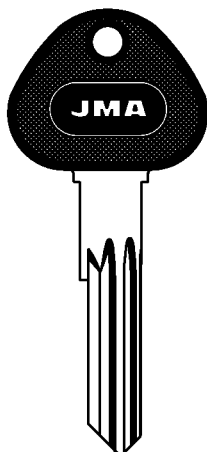

Z71....1-1043  
Z72....1-1043  
**ABU-19.P** **ABU-19D.P**  
BUFFO



  
25  
**ABU-22D**



  
20  
**ABU-23D**  
CISA

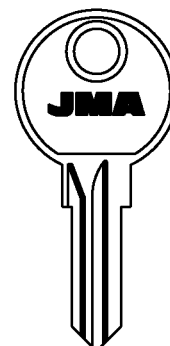

**ABU-24D**

**PARA:  
FOR:**

**ABUS**

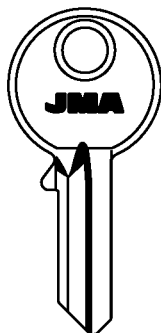

**ABU-25D**

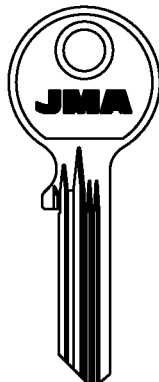

**ABU-26D**



**ABU-27** **ABU-27D**



CISA

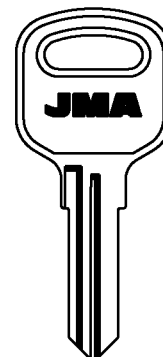

**ABU-28**

ARMSTRONG-BUFFO

Copyright by  
Alejandro Altuna S.A.  
2005

**JMA**

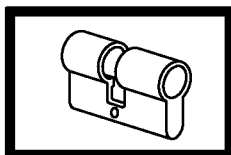

**4**

ATENCIÓN:Concerniente a las marcas y denominaciones comerciales ver nota en índice.ATTENTION:Concerning the marks and commercial denominations see note in index.  
ATTENTION:Concernant les marques et dénominations commerciales voir la note dans l'index.ACHTUNG:Beziehen auf die marke und handelsname sehen sie die notiz im index.

PARA:  
FOR:

### ABUS

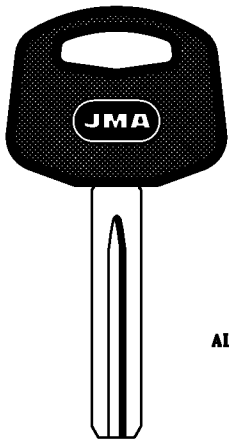

ALP.

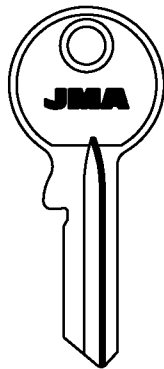
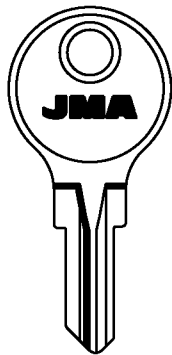

LAT.

ABU-29.P

PLUS

ABU-30 ABU-30D

ABU-32D

ANCHOR-IMP



EC 75

6.7 2.35  
ABU-34

PARA:  
FOR:

### ABUS

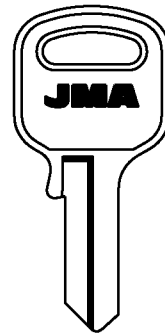
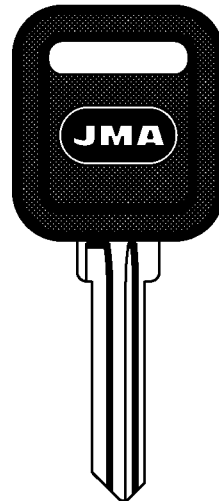
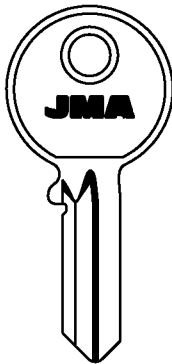
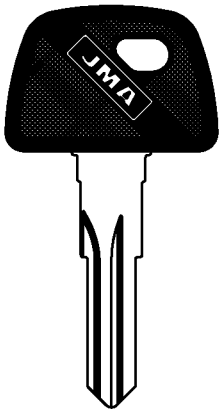

X61... 1-331 V61...  
X62... V62...

ABU-35.P ABU-36.P

BUFFO



ABU-38D

ABU-39.P



ABU-45 ABU-40  
ANCHOR-BURG-GUITTEL  
IMP-ROYAL

PARA:  
FOR:

### ABUS

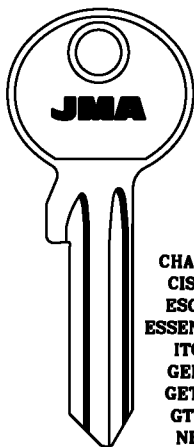

CHAVO  
CISA  
ESCO  
ESSENDIA  
ITO  
GEFI  
GETE  
GTV  
NB  
SCHUCO  
STANDARD

ABU-41 ABU-41D

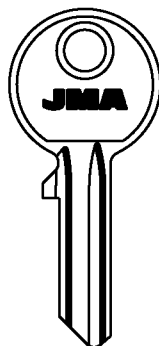

...1-342  
EF...1-724 E....  
B...1-342 ER....  
EE...1-724 801-1238

ABU-42 ABU-42D

BUFFO-CISA

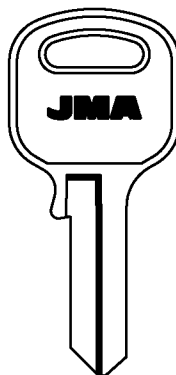

ABU-60 ABU-50

ANCHOR-JMP

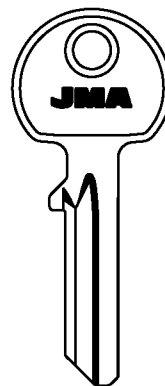

ABU-51D

**PARA-FOR:**

**ABUS (D)**

Copyright by  
Alejandro Altuna S.A.  
2005

# JMA

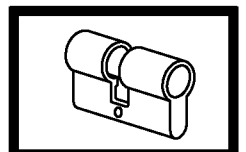

# 5

**PARA-FOR:**

**ABUS (D)**

**ADAMSRITE  
(GB)**

**AEP (RUS)**

**AGA (E)**

<b>PARA: FOR:</b>	<b>ABUS</b>	<b>ADAMSRITE</b>	<b>AEP</b>
	  <b>ABU-54 ABU-54D</b>   <b>ADS-1D</b>	 <b>ADS-1D</b>	 <b>AEP-1D</b>

<b>PARA: FOR:</b>	<b>AEP</b>	<b>AGA</b>		
	 <b>AEP-2D</b>	  <b>AGA-1I</b>	 <b>AGA-1T</b>	 <b>AGA-2T</b>

<b>PARA: FOR:</b>	<b>AGA</b>											
	  <b>AGA-3I</b>	  <b>AGA-4I AGA-4D</b>	 <b>AGA-6I</b>	 <b>AGA-5I</b>	 <b>AGA-5D</b>	 <b>AGA-18I</b>	 <b>AGA-18D</b>	 <b>AGA-19I</b>	 <b>AGA-19D</b>	 <b>AGA-18I</b>	 <b>AGA-19I</b>	

Copyright by  
Alejandro Altuna S.A.  
2005

**JMA**

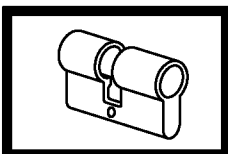

**6**

FAC-KEMEN-KIFER-RONEO

MECALUX-SUYOKA

ATENCION:Concerniente a las marcas y denominaciones comerciales ver nota en indice.ATTENTION:Concerning the marks and commercial denominations see note in index.  
ATTENTION:Concernant les marques et denominations commerciales voir la note dans l'index.ACHTUNG:Beziehen auf die marke und handelsname sehen sie die notiz im index.

PARA:  
FOR:

AGA

PARA-FOR:

AGA (E)

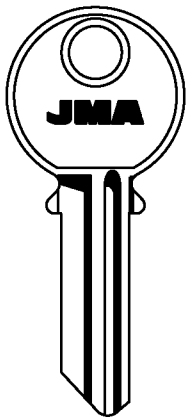

AGA-7  
JOVI

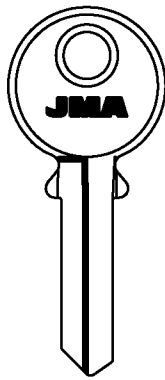

AGA-8D  
GOYAL-KEMEN

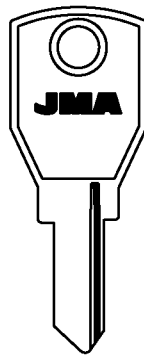

AGA-23  
ARREGUI-ALFA-GARI  
ORENGO-RUTALCHI-SERRALLER



AGA-10  
AGA-13I  
AGA-22  
GARI



AGA-9I



PARA:  
FOR:

AGA

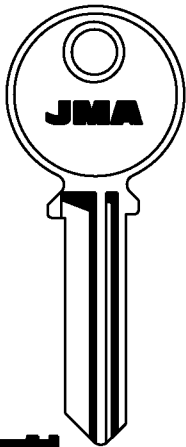

AGA-11

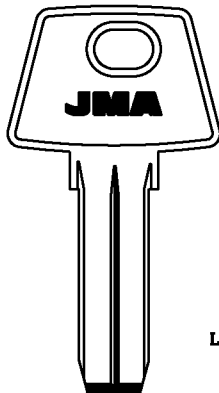

AGA-12  
COLOMENCA-FB  
SERRALLER-TERCA

LAT.

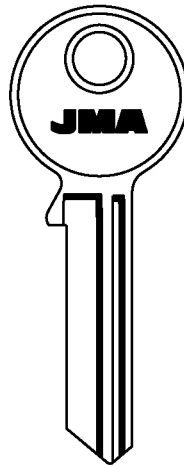

AGA-15

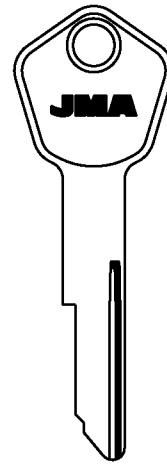

AGA-16I

PARA:  
FOR:

AGA

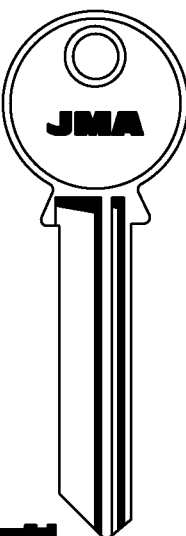

AGA-20

SERRALLER

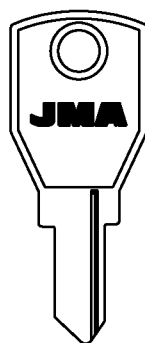

AGA-24I  
AGA-24D

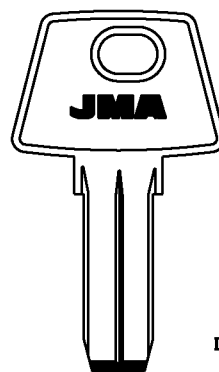

LAT.  
ALP.

AGA-29

CASAS

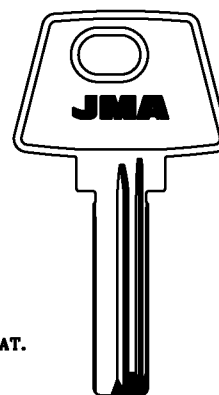

LAT.

AGA-38

Copyright by  
Alejandro Altuna S.A.  
2005

JMA

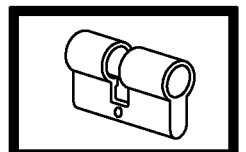

7

**PARA-FOR:**

AGA (E)

AGB (I)







AGC (P)

AGE (J)

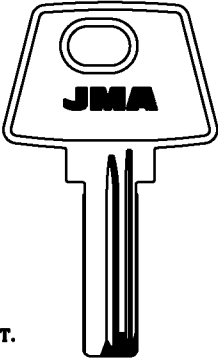
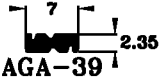
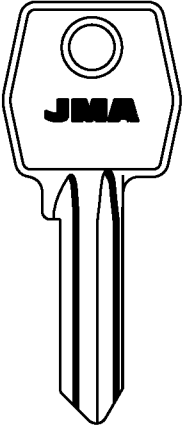
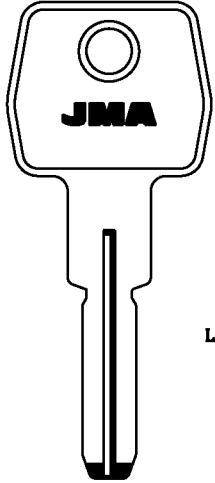
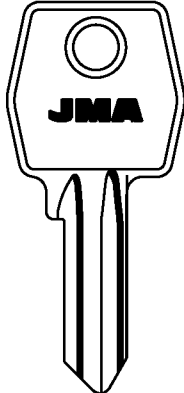
AGUIA (P)

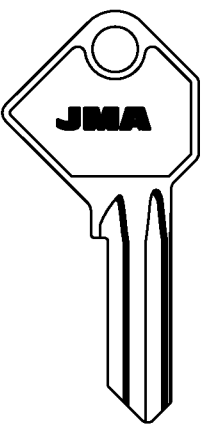
AGUT (E)

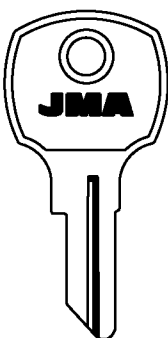
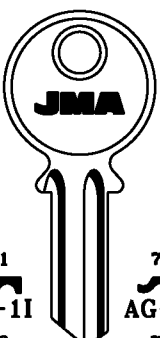
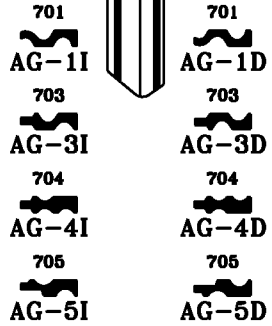
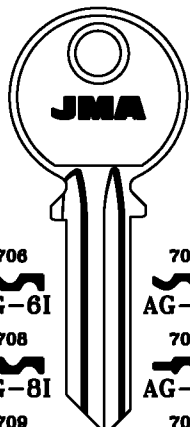
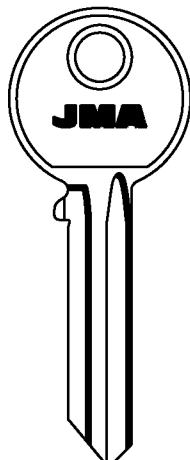
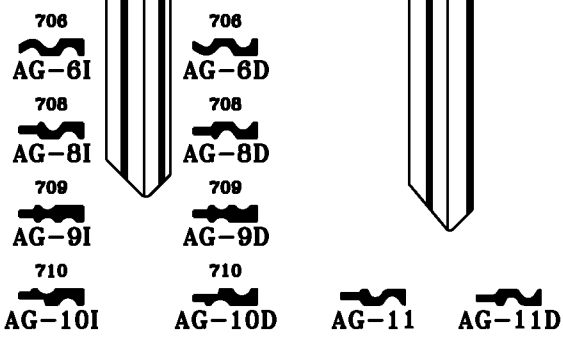
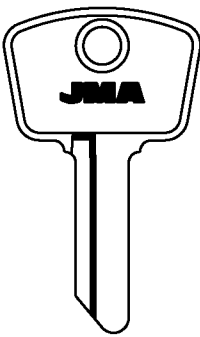
AHRAM (ET)

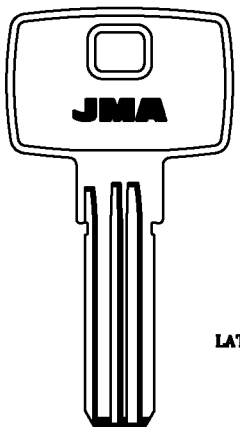
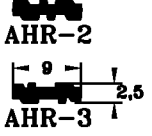
<p>PARA: FOR: AGA</p>  <p>LAT.</p>  <p>AGA-39</p>	<p>AGB</p>    <p>LAT.</p>  <p>AGB-1    AGB-1D    AGB-2    AGB-3</p> <p>OIAUS                      SCUDO                      OIAUS</p>		
<p>PARA: FOR: AGC</p>  <p>AGD-1</p>	<p>AGE</p>   <p>AGE-1I                      AGE-2D</p>		<p>AGUIA</p>   <p>AG-1I    AG-1D    AG-3I    AG-3D    AG-4I    AG-4D    AG-5I    AG-5D</p>
<p>PARA: FOR: AGUIA</p>    <p>AG-6I    AG-6D    AG-8I    AG-8D    AG-9I    AG-9D    AG-10I    AG-10D    AG-11    AG-11D</p>		<p>AGUT</p>   <p>AGU-1D</p>	<p>AHRAM</p>  <p>LAT.</p>  <p>AHR-2    AHR-3</p>

Copyright by Alejandro Altuna S.A. 2005

**JMA**

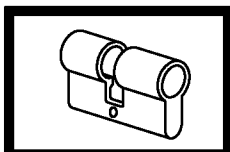

PARA:  
FOR: AIZPUTE

ALDRIDGE

ALE

PARA-FOR:

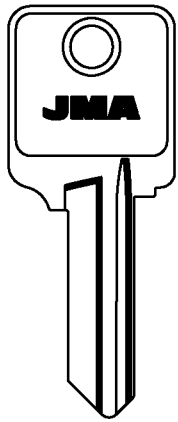

AIZ-1

AIZ-2D

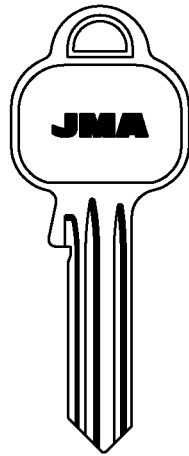

AL-11

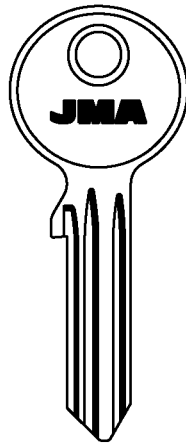

AL-2

ASEC

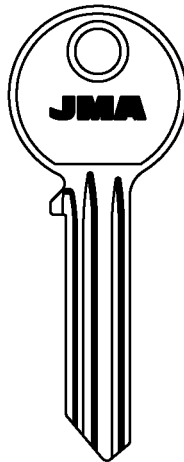

AL-3

ASEC

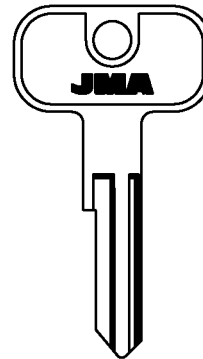

ALE-1

ALE-1D

AIZPUTE  
(RUS)

ALDRIDGE  
(GB)

ALE (ET)

ALIANCA (BR)

ALPHA (J)

ALTAY (RUS)

AMIG (E)

PARA:  
FOR: ALIANCA

ALPHA

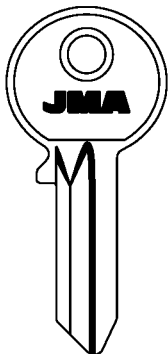

ALC-1D



ALP-11 ALP-1D

FEB

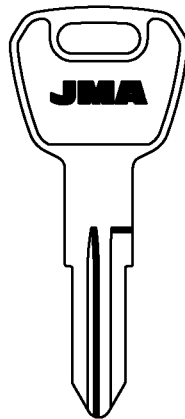

ALP-2 ALP-2D

JD-LINCE-MONACOR  
SANY-VISONIC

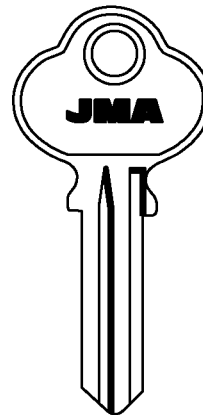

ALP-3

PARA:  
FOR:

ALPHA

ALTAY

AMIG

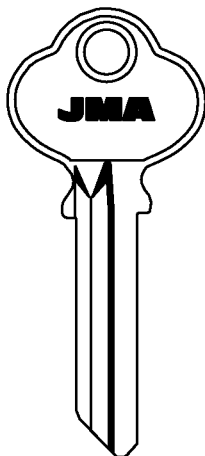

ALP-4D

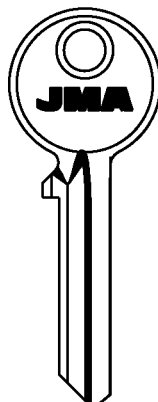

ALP-5D

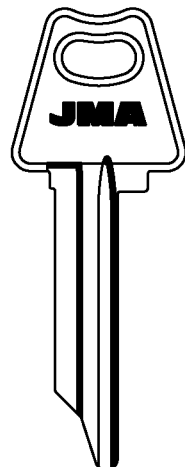

ATA-1 ATA-1D

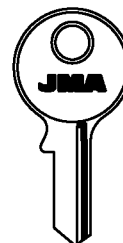

1-15 / 1-20

AMG-1

Copyright by  
Alejandro Altuna S.A.  
2005



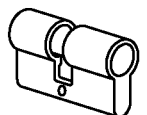



JMA





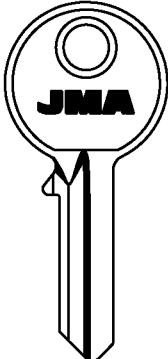
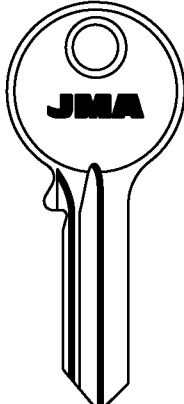





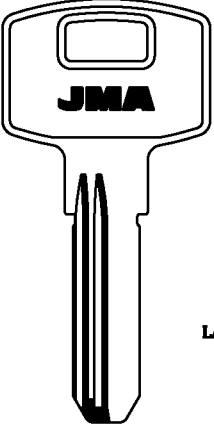
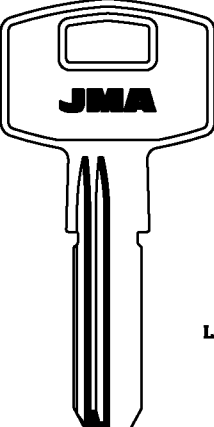
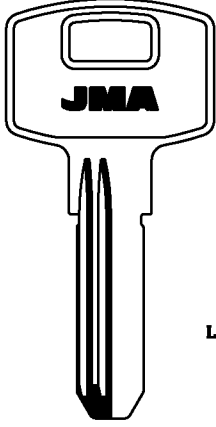
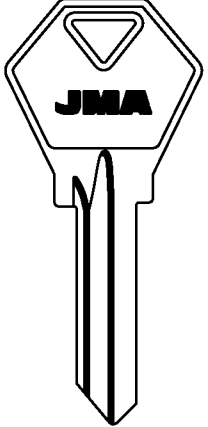

9

**PARA-FOR:**

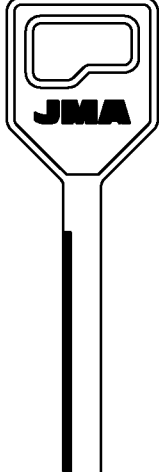
- AMIG (E)
- ANCHOR (S)
- ANKER (NL)

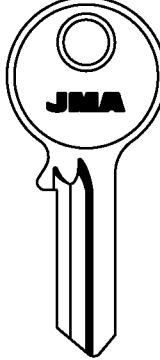
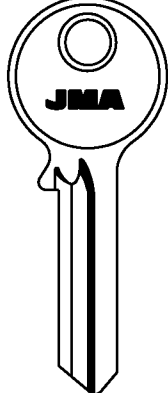
	<b>AMIG</b>			
				
1-25  AMG-2D	1-30  AMG-3D	1-40  AMG-4D	1-50  AMG-5D	

	<b>AMIG</b>			<b>ANCHOR</b>
				
LAT.	LAT.	LAT.		
 AMG-8D 5000	 AMG-9D 2500	 AMG-10D 4900	 ANC-1D ANKERSLOT	

	<b>ANCHOR</b>			<b>ANKER</b>		
						
ALP.	K...111-888 .... K.... 1011-7077 E.... F.... B.... 1-2-3-4-5-6-7 			A  ANK-2	A  ANK-3	
ANC-2	ANK-1 ANCHOR-LITTO-ODA			ODA		ODA

Copyright by  
Alejandro Altuna S.A.  
2005

**JMA**

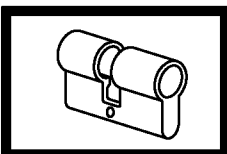

**10**

PARA:  
FOR:

### ANKER

**PARA-FOR:**

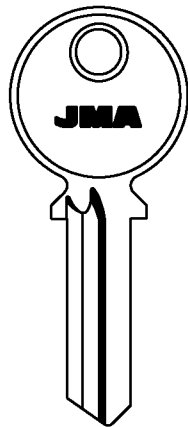

ANK-4

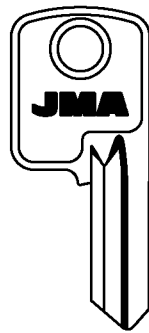

K...111-888  
....  
K...  
1011-7077  
E...  
F...  
B...  
1-2-3-4-5-6-7  
 ANK-6

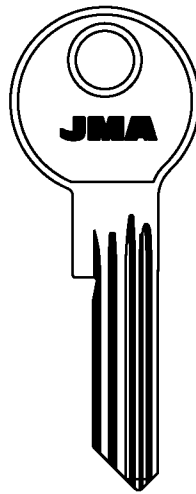

ANK-17

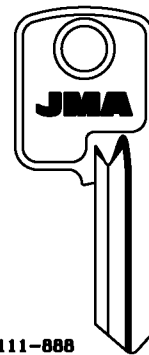

K...111-888  
....  
K...  
1011-7077  
E...  
F...  
B...  
1-2-3-4-5-6-7  
 ANK-47D

ANKER (NL)

ANTAR (F)

APEX (RUS)

ARCU (E)

AREL (GB)

ARFE (E)

PARA:  
FOR:

### ANTAR

### APEX

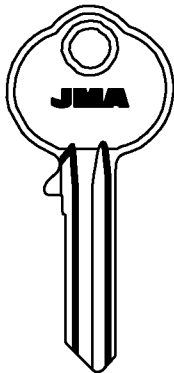

ANA-1 ANA-1D  
VEGA

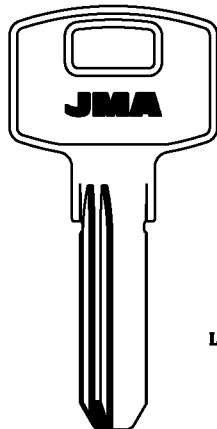

LAT.



AMIG-C.V.C.  
AP-1D

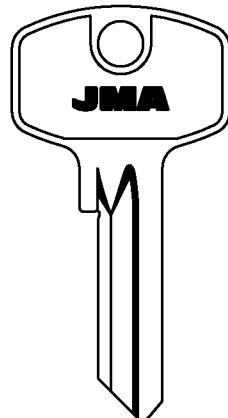

AP-2D



LAT.

AP-3D

PARA:  
FOR:

### ARCU

### AREL

### ARFE

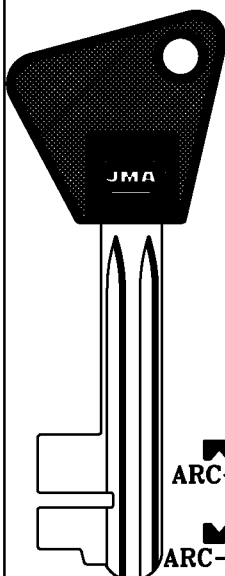

ALP.

ARC-17.P  
 ARC-17D.P

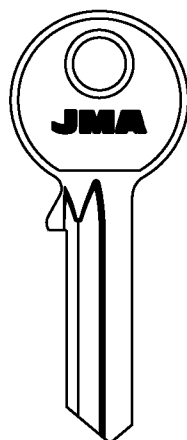

ARE-1D

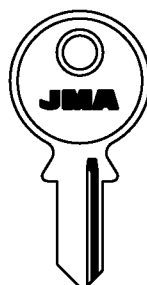

ARFE-11 ARFE-1D

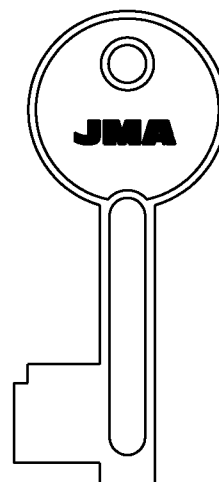

ARFE-2





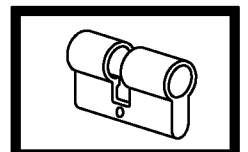



Copyright by  
Alejandro Altuna S.A.  
2005

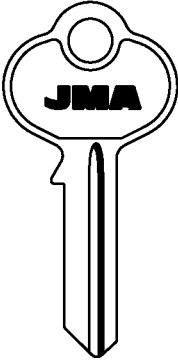
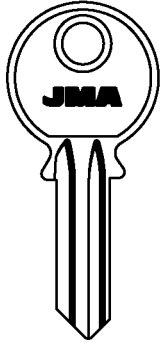
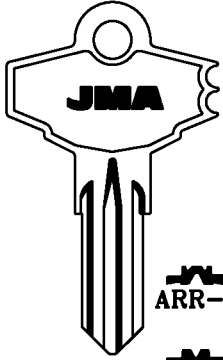



# JMA





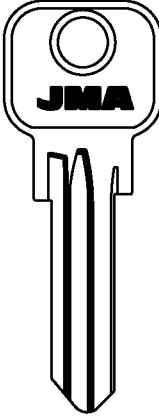
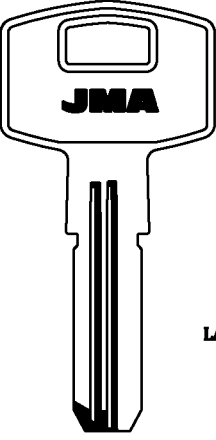
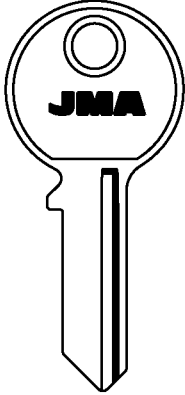

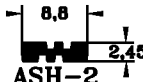



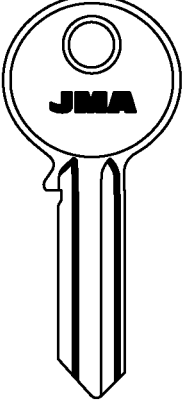
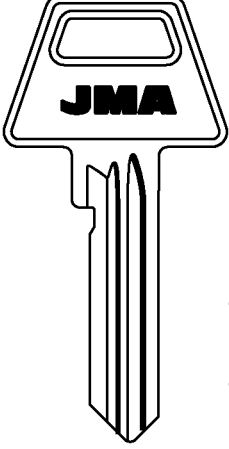







**PARA-FOR:**

- ARFE (E)
- AROUCA (BR)
- ARREGUI (E)
- ARROW (USA)
- ARSENIEVSK (RUS)
- ASHICO (TJ)
- ASIA (RC)
- ASSA (S)

<b>PARA: FOR:</b>	<b>ARFE</b>	<b>AROUCA</b>	<b>ARREGUI</b>	<b>ARROW</b>
				
	 ARFE-3D	 ARO-1D	  AR-4IP AR-4DP INDAUX	 ARR-1  ARR-2  ARR-3  ARR-8 DOMINION LOCK-FORT-LG

<b>PARA: FOR:</b>	<b>ARSENIEVSK</b>	<b>ASHICO</b>	<b>ASIA</b>
			
	 ARS-1D	LAT.  ASH-2	 45  ASI-1 CINA

<b>PARA: FOR:</b>	<b>ASSA</b>															
																
	ABC 0 AL 9  21301 AS-3I	 21201 AS-3D	TL  AS-4D	 05-04 AS-5D	 14-01 AS-6D	 05-13 AS-7D	 14-09 AS-8D	 14-25 AS-9D	 05-05 AS-10D	 AS-11D	 11-14 AS-12D	 11-01 AS-13D	 11-12 AS-14D	 11-32 AS-15D	 11-08 AS-16D	 05-14 AS-18D

Copyright by  
Alejandro Altuna S.A.  
2005

**JMA**

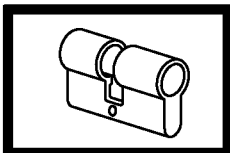

**12**

PARA:  
FOR:

ASSA

PARA-FOR:

ASSA (S)

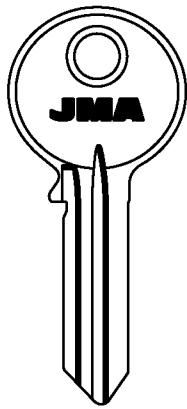

AS-20D

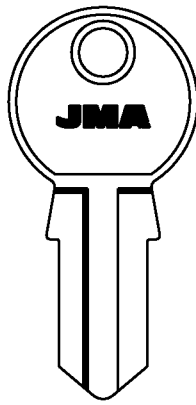

AS-22

LAT.

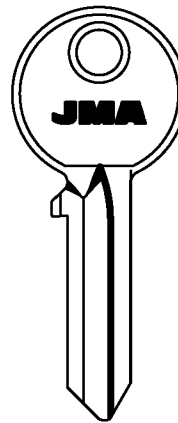

AS-23D

TEKA

PARA:  
FOR:

ASSA

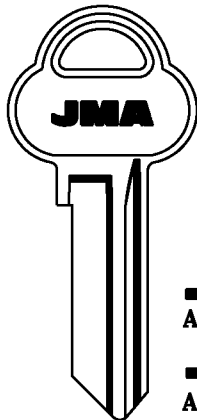

28,4 mm.

560A  
AS-A5  
560E  
AS-E5  
560M  
AS-M5  
560P  
AS-P5

560B  
AS-B5  
560F  
AS-F5  
560G  
AS-G5  
560N  
AS-N5

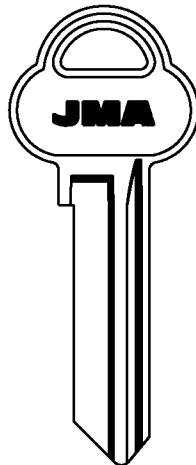

34,5 mm.

760A  
AS-A7  
760E  
AS-E7  
760L  
AS-L7  
760M  
AS-M7  
760P  
AS-P7  
760S  
AS-S7

760B  
AS-B7  
760F  
AS-F7  
760K  
AS-K7  
760G  
AS-G7  
760N  
AS-N7  
760R  
AS-R7

760RK  
AS-RK7  
760RC  
AS-RC7  
760RE  
AS-RE7  
760RG  
AS-RG7  
760RH  
AS-RH7

760RA  
AS-RA7  
760RB  
AS-RB7  
760RD  
AS-RD7  
760RF  
AS-RF7  
760RN  
AS-RN7

PARA:  
FOR:

ASSA

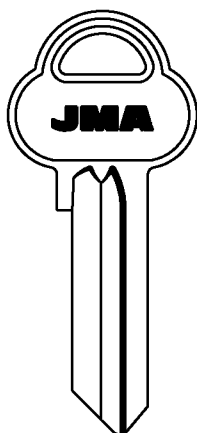

29,7 mm.

560AK  
AS-AK5  
560AL  
AS-AL5  
560AM  
AS-AM5  
560BK  
AS-BK5

560EK  
AS-EK5  
560EL  
AS-EL5  
560EM  
AS-EM5  
560FK  
AS-FK5

560DK  
AS-DK5  
560DL  
AS-DL5  
560DM  
AS-DM5

560GK  
AS-GK5  
560GL  
AS-GL5  
560GM  
AS-GM5  
560MM  
AS-MM5

560NN  
AS-NN5  
560V  
AS-V5  
560U  
AS-U5

560T  
AS-T5  
560W  
AS-W5

Copyright by  
Alejandro Altuna S.A.  
2005

JMA

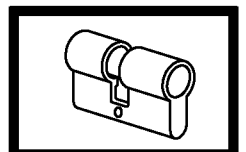

13

**PARA-FOR:**

PARA:  
FOR:

**ASSA**

**ASSA (S)**

**AUMON (E)**

**AVANGARD  
(RUS)**

**AZBE (E)**

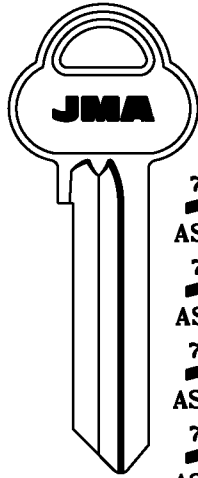

35,7 mm.

- |                 |                 |                 |                 |                 |                 |               |               |  |
|-----------------|-----------------|-----------------|-----------------|-----------------|-----------------|---------------|---------------|--|
| 760AK<br>AS-AK7 | 760EK<br>AS-EK7 | 760DK<br>AS-DK7 | 760FM<br>AS-FM7 | 760GK<br>AS-GK7 |                 |               |               |  |
| 760AL<br>AS-AL7 | 760EL<br>AS-EL7 | 760DL<br>AS-DL7 | 760GL<br>AS-GL7 |                 |                 | 760D<br>AS-D7 | 760H<br>AS-H7 |  |
| 760AM<br>AS-AM7 | 760EM<br>AS-EM7 | 760DM<br>AS-DM7 | 760GM<br>AS-GM7 |                 |                 | 760U<br>AS-U7 | 760W<br>AS-W7 |  |
| 760BK<br>AS-BK7 | 760FK<br>AS-FK7 | 760GG<br>AS-GG7 | 760MM<br>AS-MM7 | 760NN<br>AS-NN7 | 760PP<br>AS-PP7 | 760V<br>AS-V7 | 760T<br>AS-T7 |  |
| 760BL<br>AS-BL7 | 760FL<br>AS-FL7 | 760KK<br>AS-KK7 |                 | 760RR<br>AS-RR7 | 760SS<br>AS-SS7 | 760Z<br>AS-Z7 | 760X<br>AS-X7 |  |

PARA:  
FOR:

**ASSA**

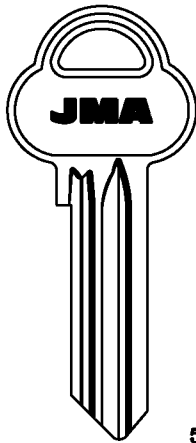

31 mm.

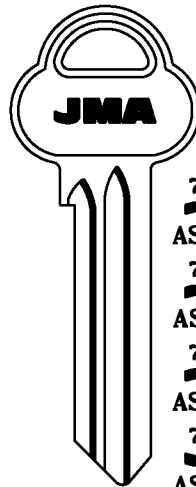

37 mm.

- |                 |                 |                 |                 |                 |                 |                 |                 |                 |                 |                 |                 |                 |                 |                 |                 |                 |                 |                 |                 |                 |                 |                 |                 |                 |                 |                 |                 |                 |                 |
|-----------------|-----------------|-----------------|-----------------|-----------------|-----------------|-----------------|-----------------|-----------------|-----------------|-----------------|-----------------|-----------------|-----------------|-----------------|-----------------|-----------------|-----------------|-----------------|-----------------|-----------------|-----------------|-----------------|-----------------|-----------------|-----------------|-----------------|-----------------|-----------------|-----------------|
| 560KE<br>AS-KE5 | 560ME<br>AS-ME5 | 760DD<br>AS-DD7 | 760HH<br>AS-HH7 | 760KA<br>AS-KA7 | 760KE<br>AS-KE7 | 760KD<br>AS-KD7 | 760KG<br>AS-KG7 | 760KF<br>AS-KF7 | 760LF<br>AS-LF7 | 760LA<br>AS-LA7 | 760LE<br>AS-LE7 | 760LD<br>AS-LD7 | 760LG<br>AS-LG7 | 760MA<br>AS-MA7 | 760ME<br>AS-ME7 | 760MD<br>AS-MD7 | 760MG<br>AS-MG7 | 760PF<br>AS-PF7 | 760PA<br>AS-PA7 | 760PH<br>AS-PH7 | 760PN<br>AS-PN7 | 760PR<br>AS-PR7 | 760PT<br>AS-PT7 | 760MF<br>AS-MF7 | 760VV<br>AS-VV7 | 760TT<br>AS-TT7 | 760UU<br>AS-UU7 | 760WW<br>AS-WW7 | 760XX<br>AS-XX7 |
|-----------------|-----------------|-----------------|-----------------|-----------------|-----------------|-----------------|-----------------|-----------------|-----------------|-----------------|-----------------|-----------------|-----------------|-----------------|-----------------|-----------------|-----------------|-----------------|-----------------|-----------------|-----------------|-----------------|-----------------|-----------------|-----------------|-----------------|-----------------|-----------------|-----------------|

PARA: **AUMON**  
FOR:

**AVANGARD**

**AZBE**

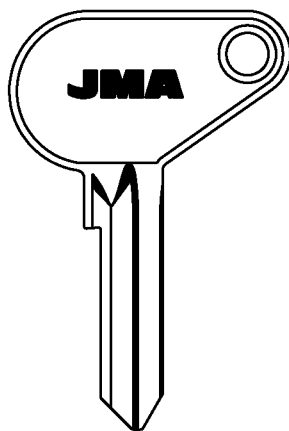

AUM-2D

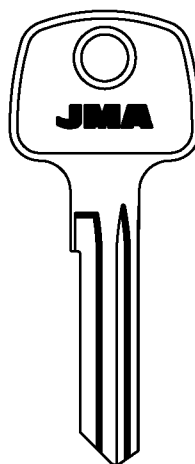

AV-1

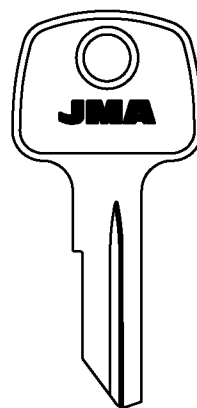

AV-1D

AV-2D

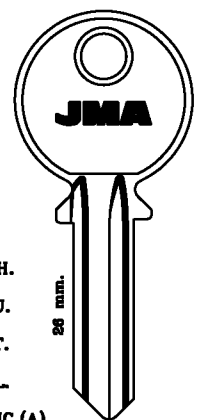

FSH.  
ALU.  
LAT.  
COL.  
• MTIC.(A)

AZ-1I

AZ-1D •

ZAIN

Copyright by  
Alejandro Altuna S.A.  
2005

**JMA**

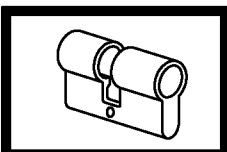

**14**

PARA:  
FOR:

### AZBE

**PARA-FOR:**

**AZBE (E)**

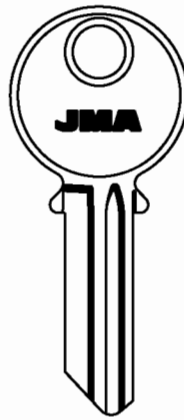
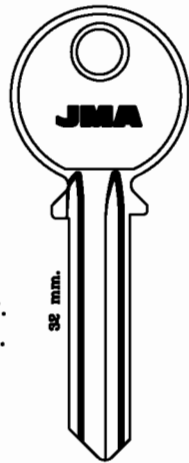
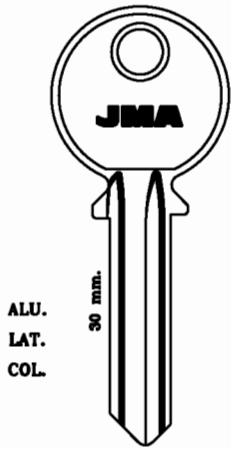

ALU.

AZ-21

AZ-2D

AZ-3I

AZ-3D

AZ-4

AZ-6

PARA:  
FOR:

### AZBE

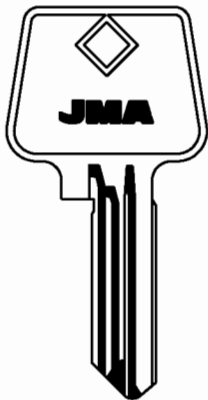

ALP.



ALP.



ALP.  
LAT.

J... I... 2.35 8.5  
AZ-9 AZ-9D

AZ-7

8.34  
2.35  
AZ-8D

2... 3...  
AZ-12

AZ-10

IFAM

CAVERS-CENTURION-ZAIN

PARA:  
FOR:

### AZBE

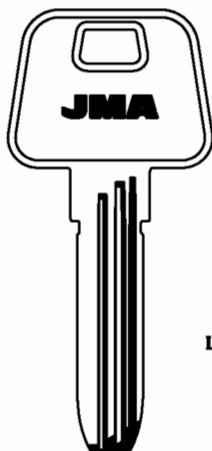

LAT.

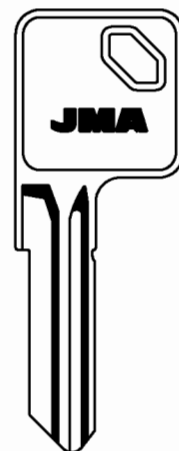
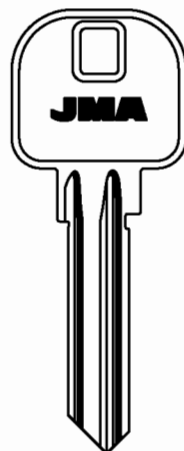

8.5  
2.35  
AZ-14

AZ-17

AZ-17D

AZ-18

AZ-18D

c  
SCO-1

SCHLAGE-SCOVILL

Copyright by  
Alejandro Altuna S.A.  
2005

**JMA**

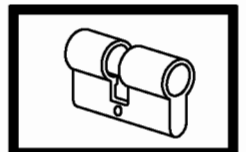

**15**

**PARA-FOR:**

**AZKOYEN (E)**







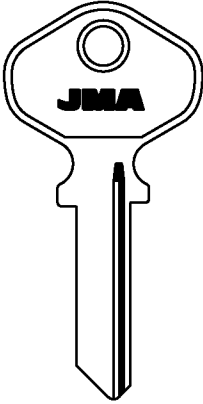
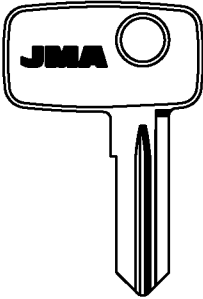
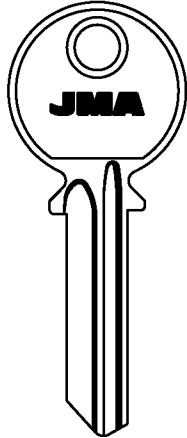
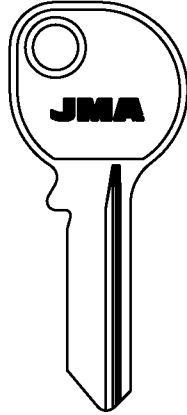

**B+D (GB)**

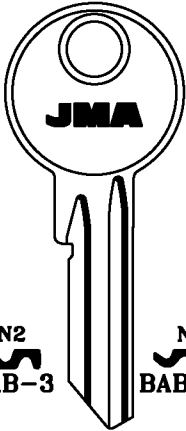
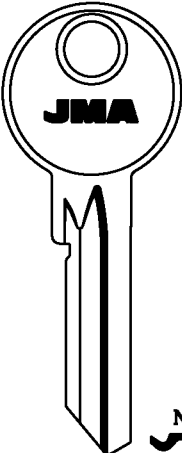
**BAB (D)**

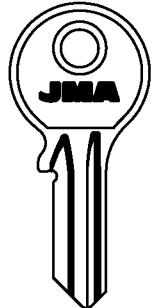
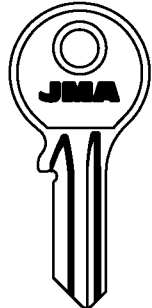
**BAGEM (E)**

**BALTIKA (RUS)**

<p>PARA: AZKOYEN FOR:</p>  <p>AZKO-11 AGA</p>	<p>B+D</p>  <p>BD-1 ROLL A DOOR</p>	<p>BAB</p>  <p>BAB-11</p>  <p>BAB-21</p>	
--	--	---	--

<p>PARA: BAB FOR:</p>				
 <p>N2 BAB-3</p> <p>N1 BAB-3D</p>	 <p>N1 BAB-4D</p>	 <p>SN2 BAB-5</p> <p>SN1 BAB-5D</p>	 <p>BAB-6</p>	 <p>BAB-7</p>
 <p>BAB-11</p>	 <p>BAB-12D</p>	 <p>BAB-5</p>	 <p>BAB-6</p>	 <p>BAB-7</p>

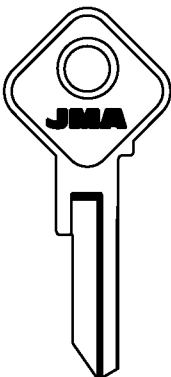
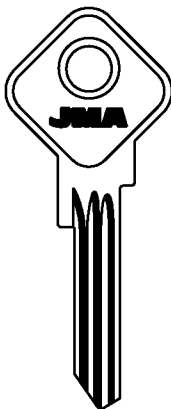
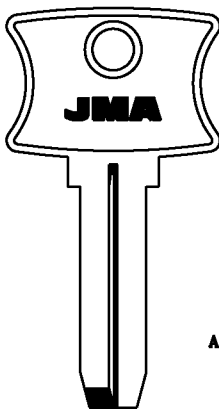
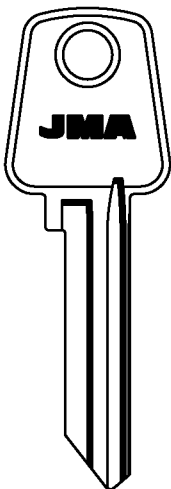
<p>PARA: BAB FOR:</p>  <p>BAB-8D</p>	 <p>BAB-9D</p>	<p>BAGEM</p>  <p>BAG-1</p> <p>ALP.</p> <p>8.7 2.3</p>	<p>BALTIKA</p>  <p>BLT-1</p>
---	---	---	---

Copyright by  
Alejandro Altuna S.A.  
2005

**JMA**

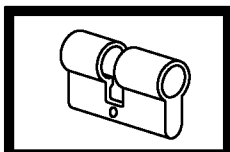

**16**

<b>PARA:</b> <b>FOR:</b>	<b>BANHAM</b>	<b>PARA-FOR:</b> <b>BANHAM (GB)</b> <b>BARCZ (PL)</b> <b>BARIER (RUS)</b> <b>BASCO (USA)</b> <b>BASH (USA)</b> <b>BASI (D)</b> <b>BASTA (IRL)</b>

<b>PARA:</b> <b>FOR:</b>	<b>BARIER</b>	<b>BASCO</b>	<b>BASH</b>
	  <b>BRR-1</b>	  <b>BAS-4</b> AMERICAN M.-B&S-CHICAGO ELMO-HERSEE-ILLINOIS-YALE	  LAT.

<b>PARA:</b> <b>FOR:</b>	<b>BASH</b>	<b>BASI</b>	<b>BASTA</b>	
	  <b>BSH-2</b>	  <b>BAI-1D</b>	  <b>BAST-1I</b>	  <b>BAST-2D</b>

Copyright by  
Alejandro Altuna S.A.  
2005



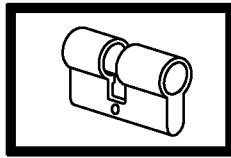

**JMA**





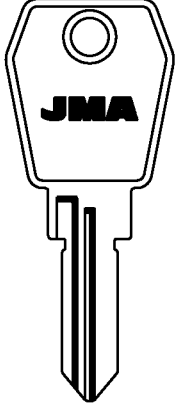
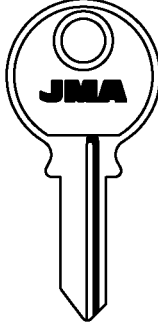
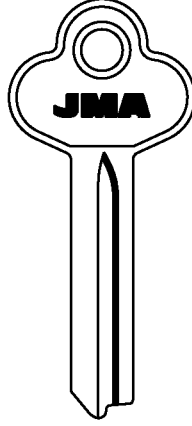
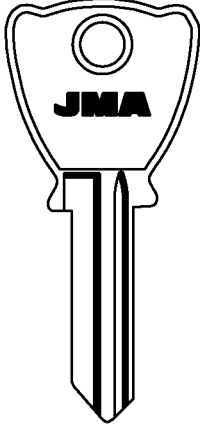



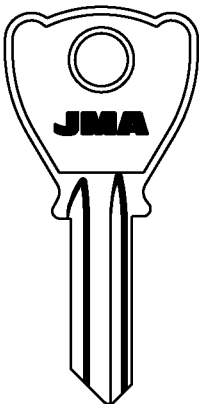
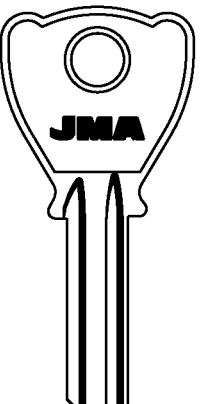
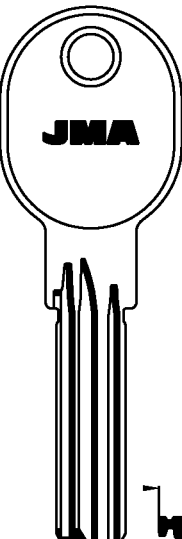
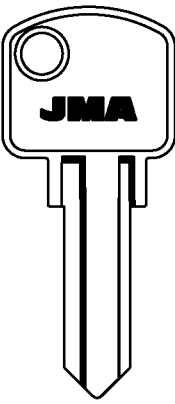
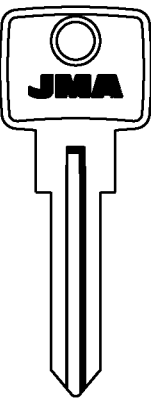

**ATENCION:**Concerniente a las marcas y denominaciones comerciales ver nota en indice.**ATTENTION:**Concerning the marks and commercial denominations see note in index.  
**ATTENTION:**Concernant les marques et denominations commerciales voir la note dans l'index.**ACHTUNG:**Beziehen auf die marke und handelsname sehen sie die notiz im index.

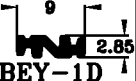
**PARA-FOR:**

- BASTA (IRL)**
- BATU (E)**
- BEST (USA)**
- BETA (I)**
- BEY (TR)**
- BIBERING (D)**
- BIELLE (I)**
- BIFFAR (D)**
- BILMA (E)**

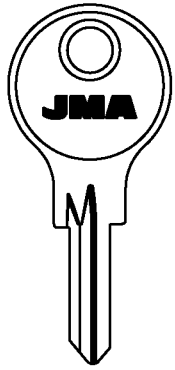
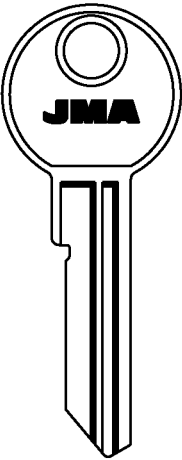
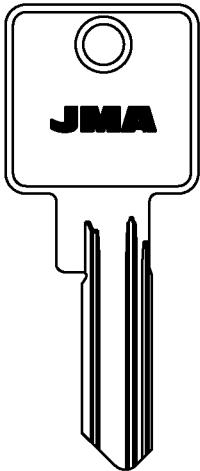
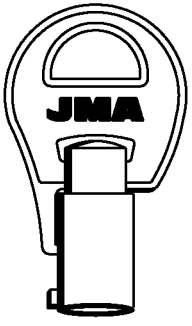
<b>PARA: FOR:</b>	<b>BASTA</b>	<b>BATU</b>	<b>BEST</b>	<b>BETA</b>
				
	 <b>BAST-3D</b>	 <b>BATU-1I</b>	 <b>BES-1D</b>	 <b>BE-1</b>
	<b>EURO LOCKS</b>		<b>FALCON</b>	

<b>PARA: FOR:</b>	<b>BETA</b>	<b>BEY</b>	<b>BIBERING</b>
	 		 
	 <b>BE-4I BE-4D BE-5I BE-5D</b>	 <b>BEY-1D</b>	 <b>BI-1D BI-2</b>
	<b>PICARD</b>		<b>TAS-TÜRSCHLOSS</b>

<b>PARA: FOR:</b>	<b>BIBERING</b>	<b>BIELLE</b>	<b>BIFFAR</b>	<b>BILMA</b>
				
	 <b>BI-3D</b>	 <b>BIE-1</b>	 <b>BFA3 BIF-1</b>	 <b>BIL-1T</b>
		<b>FASEM-OMIV-P.C.</b>	<b>FICHET-TOK</b>	

Copyright by  
Alejandro Altuna S.A.  
2005

**JMA**

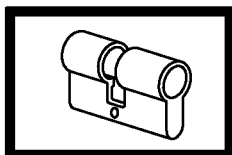

**18**

PARA:  
FOR:

### BKS

**PARA-FOR:**

**BKS (D)**

**BODA (SF)**

**BOMORO (D)**

**BÖRKEY (D)**

BERRY  
DAMM  
GEBE  
HOHRMANN  
PZ  
YALE  
38  
BK-1I  
NA  
BK-1D  
ALU.  
BK-2D  
YALE  
R  
101-105  
BK-3D  
YALE-WECO  
34  
BK-4  
T  
BK-4D  
BK-5I  
BK-5D  
METEOR-YALE

PARA:  
FOR:

### BKS

38  
BK-6I  
NA  
BK-6D  
NA  
BK-7D  
NA  
BK-8D  
BERRY  
DAMM  
GEBE  
HOHRMANN  
PZ  
YALE  
BK-9  
SERIE 0

PARA:  
FOR: BODA

### BOMORO

### BÖRKEY

BOD-1  
BOM-1  
BOM-1D  
BOM-2  
BOM-2D  
LAPORTE-PRESTA  
8,2  
1,95  
BKY-1  
PHILLIPS-YALTRES  
LAT.

Copyright by  
Alejandro Altuna S.A.  
2005

**JMA**

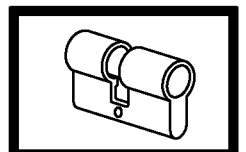

**19**





**PARA-FOR:**



**BÖRKEY (D)**

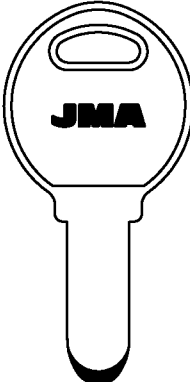
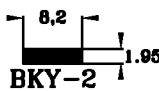
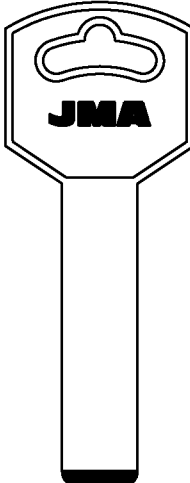

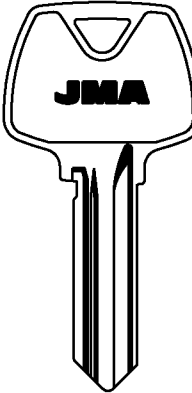

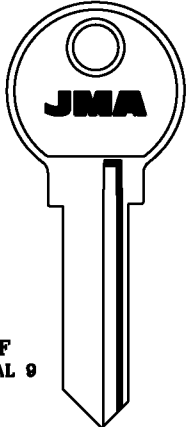
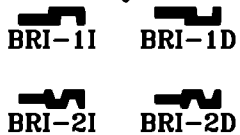

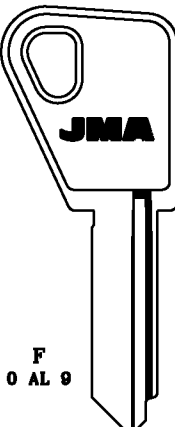
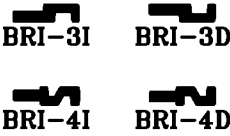
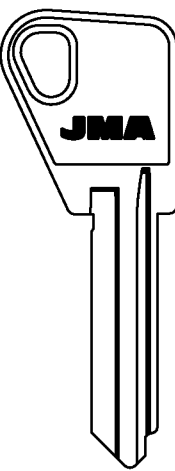
**BRAS (E)**

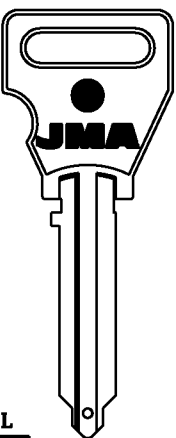
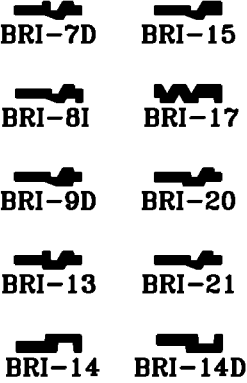
**BRASIL (BR)**

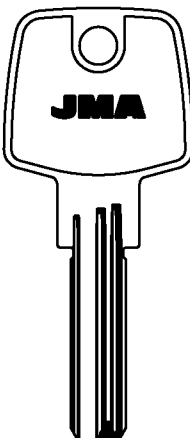
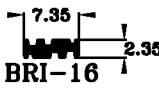
**BRICARD (F)**

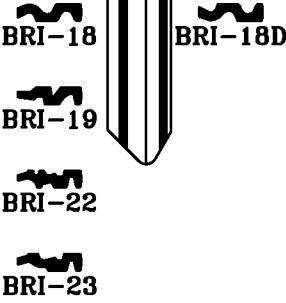
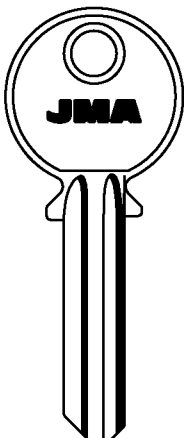
PARA: FOR:	BÖRKEY	BRAS	BRASIL	BRICARD
	 <p>LAT.</p>  <p>BKY-2</p> <p>PHILLIPS-YALTRES</p>	 <p>ALP.</p>  <p>BRAS-1</p>	  <p>BRS-1</p>	 <p>F 0 AL 9</p>  <p>BRI-11 BRI-1D BRI-2I BRI-2D</p> <p>STREMLER</p>

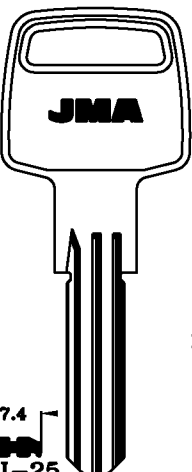
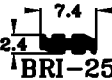
PARA: FOR:	BRICARD			
	 <p>F 0 AL 9</p>  <p>BRI-3I BRI-3D BRI-4I BRI-4D</p>	 <p>F 0 AL 9</p>  <p>BRI-6I BRI-6D</p>	 <p>BL</p>  <p>BRI-7D BRI-15 BRI-8I BRI-17 BRI-9D BRI-20 BRI-13 BRI-21 BRI-14 BRI-14D BRI-12</p>	<p>LAT.</p> <p>BLOCTOUT-INLOC</p>



PARA: FOR:	BRICARD			
	 <p>LAT.</p>  <p>BRI-16</p>	  <p>BRI-18 BRI-18D BRI-19 BRI-22 BRI-23</p> <p>ABUS</p>	  <p>BRI-24</p>	 <p>LAT.</p>  <p>BRI-25</p>  <p>BRI-27</p>

Copyright by  
Alejandro Altuna S.A.  
2005

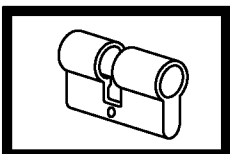
**JMA**



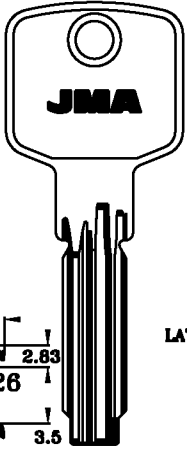
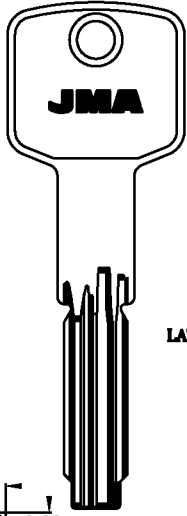
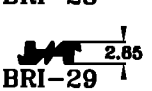
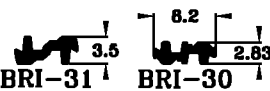
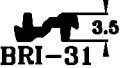
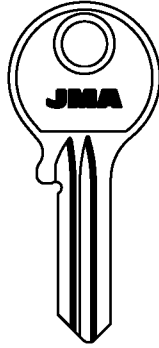
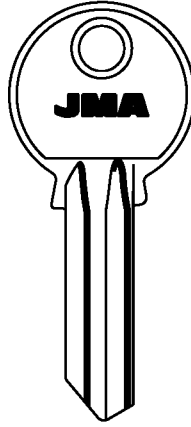





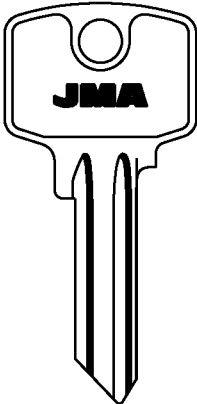
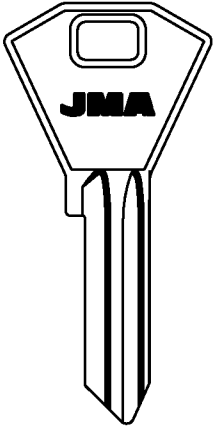

**20**

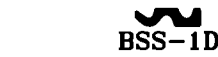
<b>PARA: FOR:</b>	<b>BRICARD</b>			<b>BRUMME</b>
				
				
				
				
				FANA

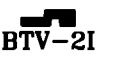
**PARA-FOR:**

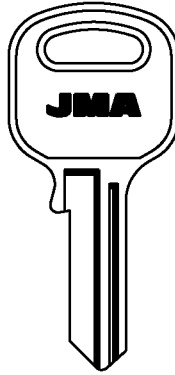
- BRICARD (F)**
- BRUMME (D)**
- BSS (YU)**
- BTV (E)**
- BUGA (D)**
- BURG (D)**

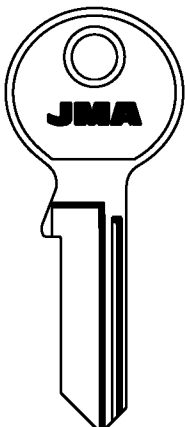
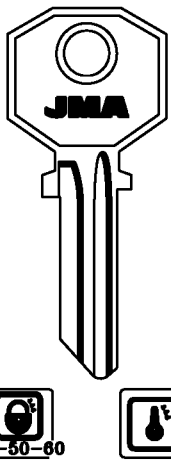
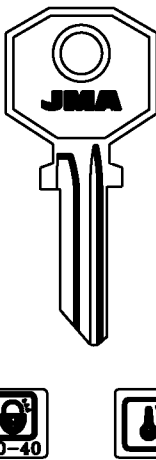
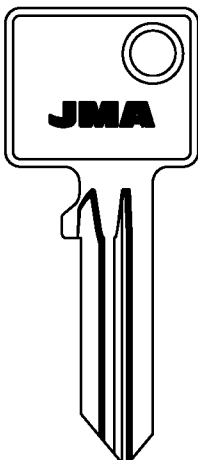
<b>PARA: FOR:</b>	<b>BSS</b>	<b>BTV</b>	<b>BUGA</b>
			
			
			
	BANE SEKULIC	SADV	

<b>PARA: FOR:</b>	<b>BUGA</b>	<b>BURG</b>		
				
				
		MELSMETALL		

Copyright by  
Alejandro Altuna S.A.  
2005

**JMA**

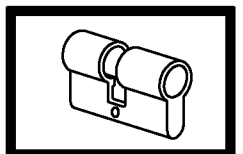

**PARA-FOR:**

**BURG (D)**

**PARA-FOR:** **BURG**

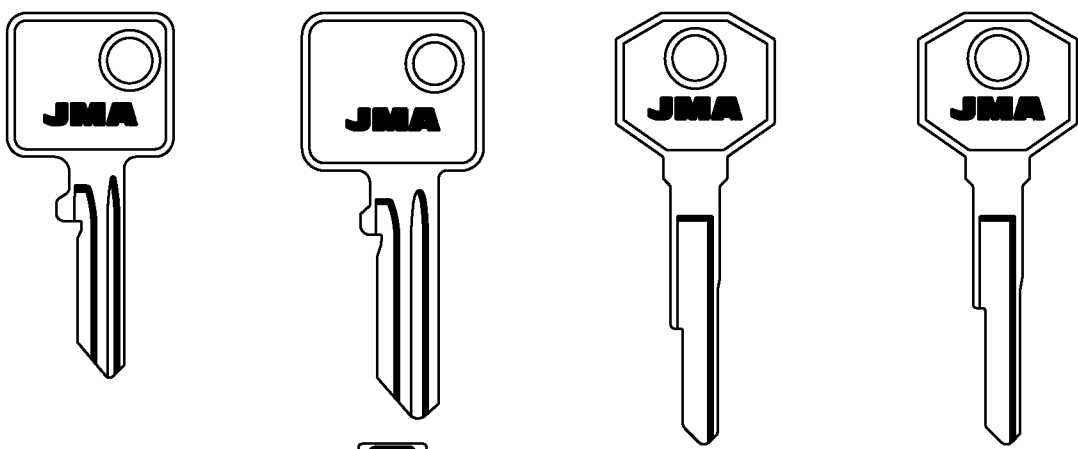

**BUR-4** **BUR-4D** **BUR-5** **BUR-5D** **BUR-6** **BUR-7**

MELSMETALL

**PARA-FOR:** **BURG**

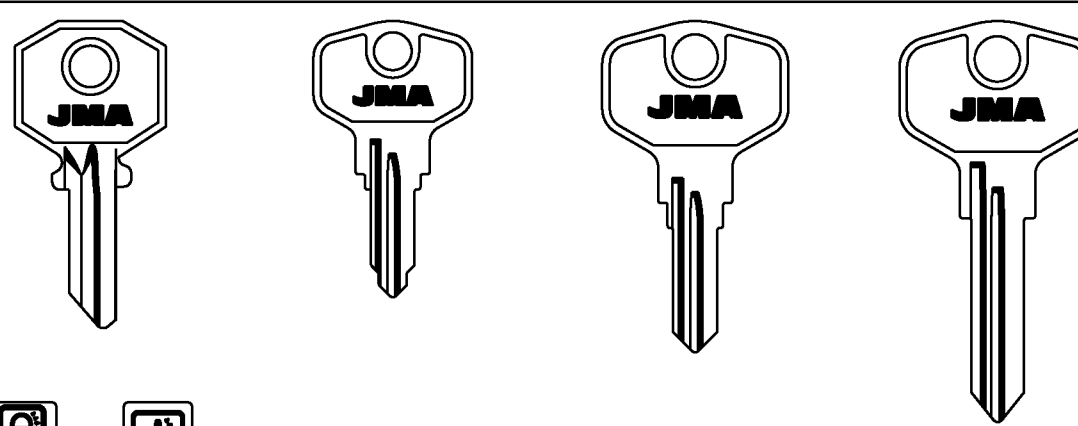

**BUR-8D** **BUR-9D** **BUR-10D** **BUR-11D**

1/91/9...  
0 AL 6

ATL-BURGWACHTER-BUVA-HEWY  
DURABLE-HOPPE-RITTAL-WSM  
CIBOX-HOPPE-KIND-ROTO  
ANKE-BURG WACHTER

**PARA-FOR:** **BURG**

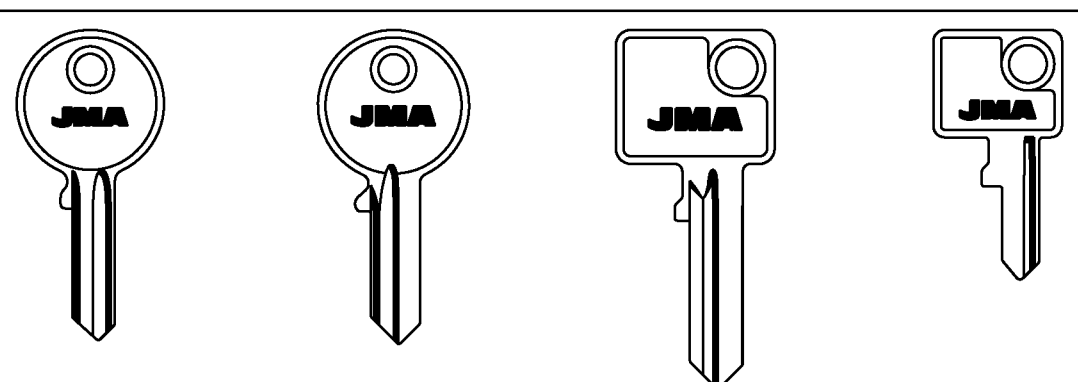

**BUR-12** **BUR-13D** **BUR-14D** **BUR-15**

DESAL  
ITEM-RITTAL

Copyright by  
Alejandro Altuna S.A.  
2005

**JMA**

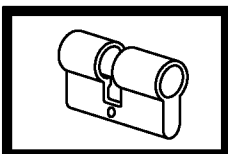

PARA:  
FOR:

### BURG

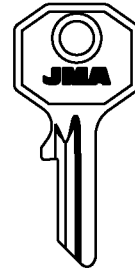
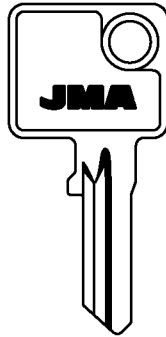
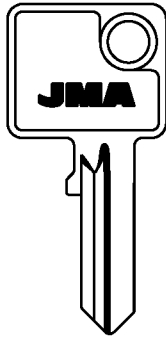

BUR-17D  
222 C90  
BUR-20D

BUR-16

BUR-18D

BUR-21D

**PARA-FOR:**

**BURG (D)**

**BUS (D)**

**BUVA (D)**

**CARTERO (E)**

**CAS CISMA (I)**

**CASAS (E)**

PARA:  
FOR:

### BURG

### BUS

### BUVA

### CARTERO

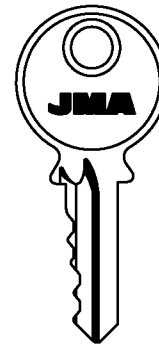
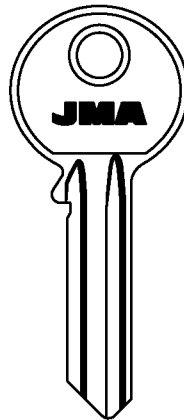
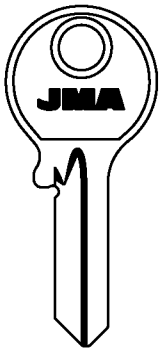

BUR-22D

BUS-1  
KROST

BU-1I BU-1D

C  
AGA-FAC-ST5

PARA:  
FOR:

### CAS CISMA

### CASAS



ETNA  
GSA  
LAPERCHE  
STREMLER

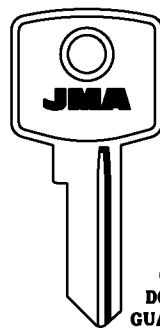

BY  
CAB  
DOMUS  
GUARDIAN  
MST  
SISO  
STIQAM  
TESTA

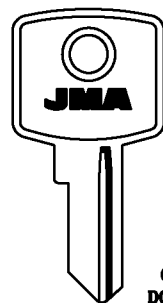

BY  
CAB  
DOMUS  
GUARDIAN  
MST  
SISO  
STIQAM  
TESTA

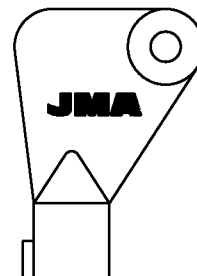

Copyright by  
Alejandro Altuna S.A.  
2005

**JMA**

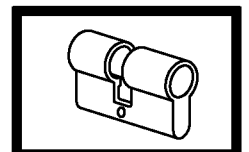

L....  
1001-2178  
CIS-1I CIS-1D

CIS-2

CIS-3

CIS-4

CIS-5









CASAS-1T





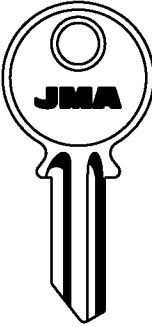

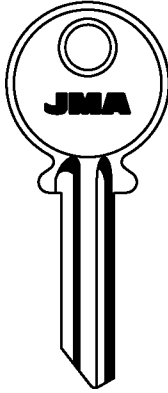

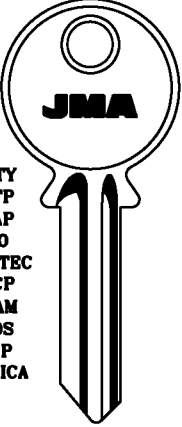

**PARA-FOR:**



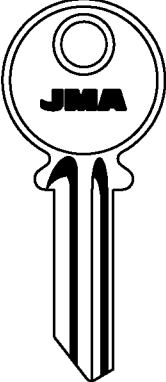

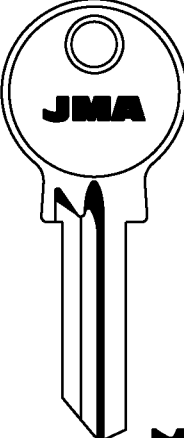

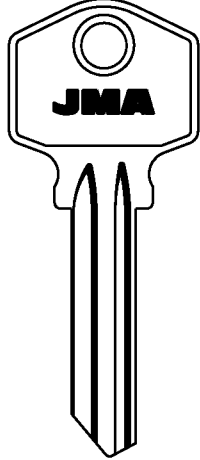
**CASH BOX (D)**

**CAVERS (F)**

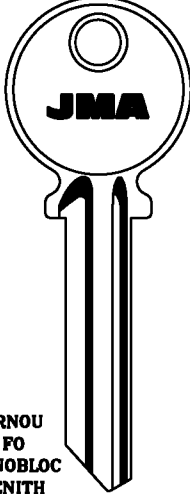
**CAYS (E)**

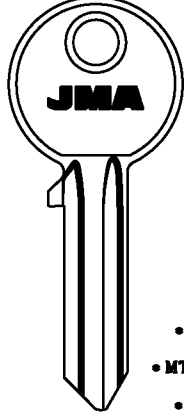
<p><b>PARA: CASH BOX</b></p> <p><b>FOR:</b></p>   <p>CSB-1D 0-1-2</p>  <p>CSB-2D</p> <p>ARREGUI</p>	<p><b>CAVERS</b></p>   <p>CA-1I</p> <p>CITY</p>	  <p>CA-2I</p>  <p>CA-10I</p> <p>CITY-ZENICA</p>	  <p>CA-3I</p>  <p>CA-9I</p> <p>CITY-KVR</p>
--	---	--	---

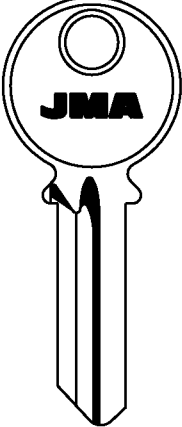
<p><b>PARA: CAVERS</b></p> <p><b>FOR:</b></p> <p>CITY ATP CAP FO PROTEC QCP SIAM SOS VIP ZENICA</p>	  <p>CA-4I</p>  <p>CA-4D</p>  <p>CA-12I</p>	  <p>CA-5I</p>  <p>CA-11I</p> <p>ZENITH-ZENICA</p>	  <p>CA-6D</p>  <p>CA-13D</p> <p>ZENITH-ZENICA</p>	  <p>CA-7</p>  <p>CA-7D</p> <p>FO-ZENITH</p>
---	--	--	---	--

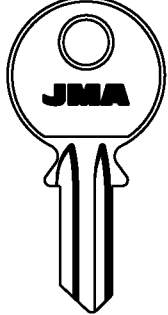
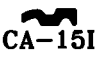

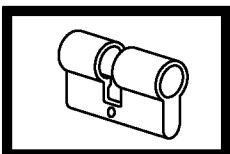

<p><b>PARA: CAVERS</b></p> <p><b>FOR:</b></p>   <p>CA-8I</p>  <p>CA-8D</p> <p>ARNOU FO MONOBLOC ZENITH</p>	<p><b>CAYS</b></p>   <p>CAY-1I</p>  <p>CAY-1D</p> <ul style="list-style-type: none"> <li>• ALU.</li> <li>• MTIC.(Y)</li> <li>• FSH.</li> </ul>
  <p>CA-14D</p> <p>ZENI</p>	  <p>CA-15I</p> <p>CITY</p>

Copyright by  
Alejandro Altuna S.A.  
2005

**JMA**

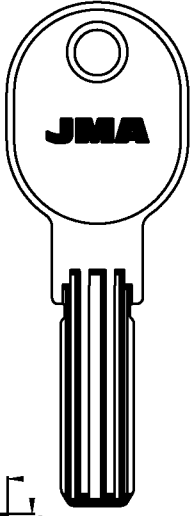
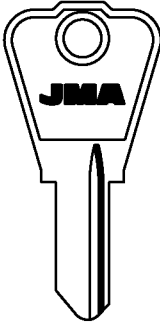
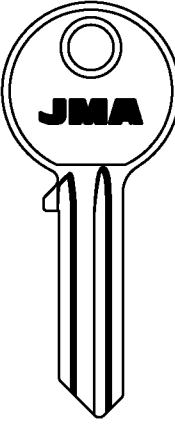
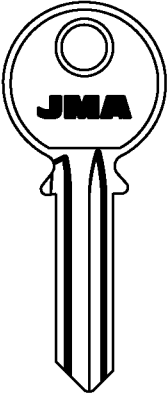
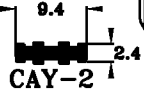









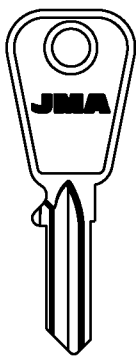
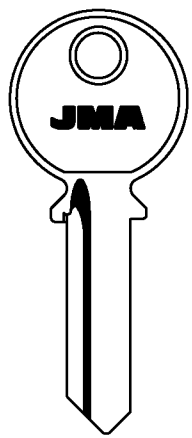
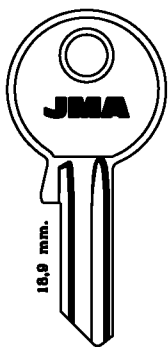







**24**

<b>PARA: FOR:</b> CAYS	<b>CEMA</b>	<b>CENTURY</b>	
			
LAT. 	 CMA-1	 CMA-1D	
ISEO	 CMA-2	 CMA-2D	
	ELFIN-LAMPA	ALLGOOD	ALLGOOD

**PARA-FOR:**

- CAYS (E)
- CEMA (I)
- CENTURY (GB)
- CERRAMARC (E)
- CES (D)

<b>PARA: FOR:</b> CENTURY	<b>CERRAMARC</b>	<b>CES</b>
		
WR 1 AL 4  CENT-3D	 CER-1	 CE-1I
		 CE-1D
		STUV

<b>PARA: FOR:</b>	<b>CES</b>		
	 CE-110	 CE-108	
1C 401-410 10C 1-10 HLV 911-950 BODA ELZETT FRECOV KNAPP	ELZETT FRECOV HAEFELE HANNO JOSTA KARDEX KIND KNAPP MAUSER NEMEF OJMAR SANTIS VOKO WASO WECO	 CE-101D	ELZETT FRECOV HAEFELE HANNO JOSTA KARDEX KIND KNAPP MAUSER NEMEF OJMAR VOKO WASO WECO
 CE-2I	 CE-2D	 CE-99D	 CE-3I
		 CE-3D	 CE-4D
			CASMA-SPEEDAL

Copyright by  
Alejandro Altuna S.A.  
2005

**JMA**

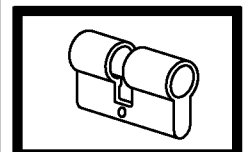

**25**

**PARA-FOR:**

PARA:  
FOR:

**CES**

**CES (D)**

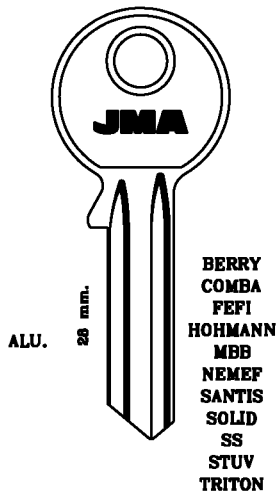

ALU. 28 mm.

BERRY  
COMBA  
FEFI  
HOHMANN  
MBB  
NEMEF  
SANTIS  
SOLID  
SS  
STUV  
TRITON

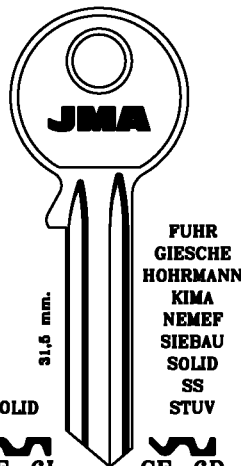

31.5 mm.

FUHR  
GIESCHE  
HOHRMANN  
KIMA  
NEMEF  
SIEBAU  
SOLID  
SS  
STUV



BODA

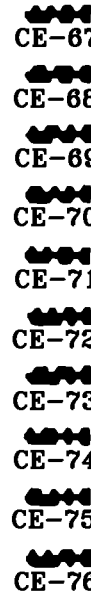
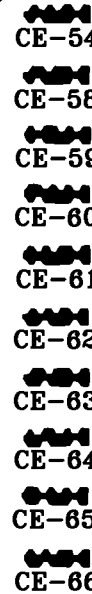

LAT.

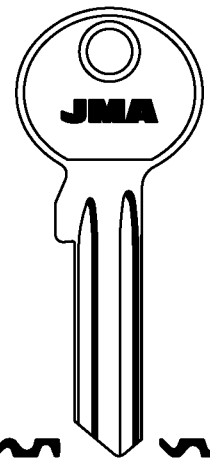

NEMEF

PARA:  
FOR:

**CES**

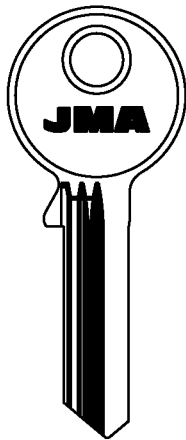

X23 CE-9D	X30 CE-16D	X37 CE-23D	W24 CE-30D	W31 CE-37D	
X24 CE-10D	X31 CE-17D	X38 CE-24D	W25 CE-31D	W32 CE-38D	
X25 CE-11D	X32 CE-18D	X39 CE-25D	W26 CE-32D	W33 CE-39D	W38 CE-44D
X26 CE-12D	X33 CE-19D	X40 CE-26D	W27 CE-33D	W34 CE-40D	W39 CE-45D
X27 CE-13D	X34 CE-20D	X41 CE-27D	W28 CE-34D	W35 CE-41D	W40 CE-46D
X28 CE-14D	X35 CE-21D	X42 CE-28D	W29 CE-35D	W36 CE-42D	W41 CE-47D
X29 CE-15D	X36 CE-22D	W23 CE-29D	W30 CE-36D	W37 CE-43D	W42 CE-48D

SOLID

PARA:  
FOR:

**CES**

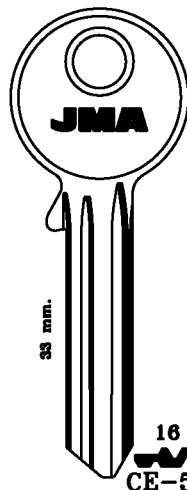
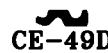
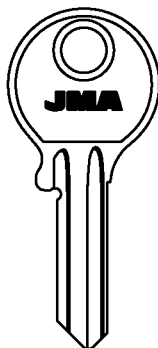

33 mm.

12....1-100000



BODA

26 CE-55	35 CE-81
27 CE-56	36 CE-82
28 CE-57	37 CE-83
15 CE-77	38 CE-84
17 CE-78	45 CE-85
18 CE-79	46 CE-86
25 CE-80	47 CE-87
	48 CE-88

LAT.

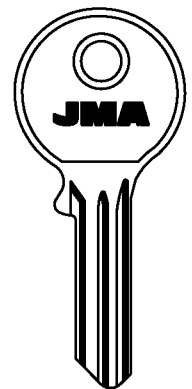

Copyright by  
Alejandro Altuna S.A.  
2005

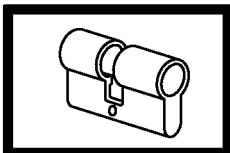

**26**

PARA:  
FOR:

CES

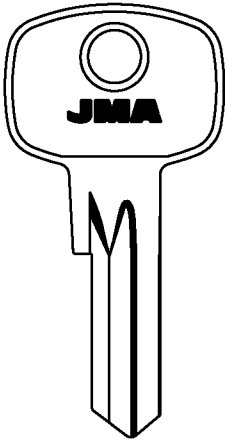

CE-53D



CE-89

CE-89D



CE-94

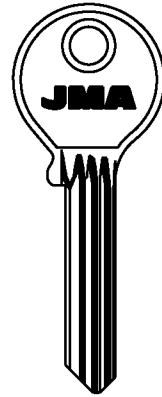

CE-96

CE-97

LAT.



**PARA-FOR:**

CES (D)

CHAVO (P)

CHELIABINSK  
(RUS)

CHEYLOCK  
(HK)

PARA:  
FOR:

CES

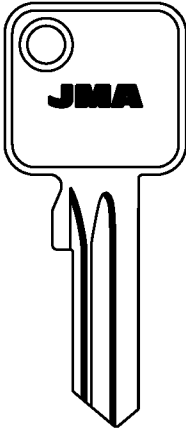

CE-98D

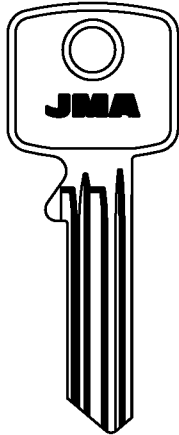

CE-105

CE-103

CE-102

CE-111D

CE-104D

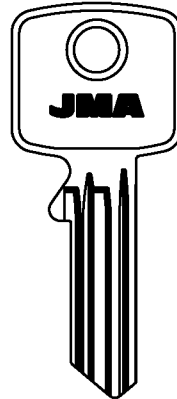

CE-107

CE-106

CASMA-SPEEDAL

PARA:  
FOR:

CES

CHAVO

CHELIABINSK

CHEYLOCK

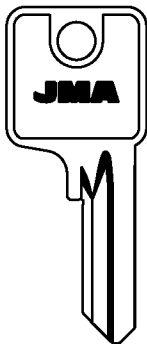

CE-109D

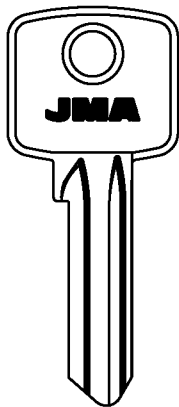

CHA-2

CHA-2D

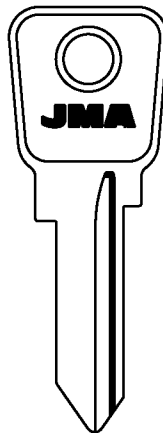

CHTZ-1

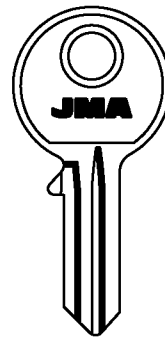

CHEK-1

Copyright by  
Alejandro Altuna S.A.  
2005

**JMA**

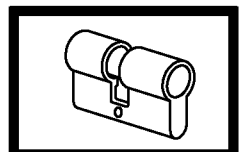

27

**PARA-FOR:**

**CHICAGO  
(USA)**

**CHUBB (GB)**

**CIEF (F)**

**CIELS (F)**

**CIFIAL (P)**

**PARA: CHICAGO**  
**FOR:**

CHI-1 CHI-2  
CHI-3 CHI-4  
CHI-5

CHI-1T  
ACE-ADEMCO-AGA-ALPHA  
EURO LOCKS-FORT-GEM-L & F

LAT.

CHI-6  
ILLINOIS ODA

FR  
CHI-7D  
FR  
CHI-8D  
XF  
CHI-9D  
XF  
CHI-10D  
STEELCASE

**PARA: CHUBB**  
**FOR:**

LAT.

CHU-1D  
CHU-10  
AVA-CHUBB

**PARA: CIEF**  
**FOR:**

CF-1I CF-1D  
ESAFE-FEB

**PARA: CIELS**  
**FOR:**

CIE-1D

**PARA: CIFIAL**  
**FOR:**

CIF-1D  
LAFEBURE

CIF-2D  
LAFEBURE

CIF-3  
EFER

CIF-4  
EFER

Copyright by  
Alejandro Altuna S.A.  
2005

**JMA**

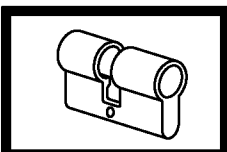

<b>PARA: FOR:</b> <div style="text-align: center;"><b>CILA-GENTILI</b></div>	<b>CINA</b> 	<b>CISA</b> 	<b>PARA-FOR:</b> <b>CILA-GENTILI (I)</b> <b>CINA (RC)</b> <b>CISA (I)</b>
---	-----------------	-----------------	--

<b>PARA: FOR: CISA</b>			
<p style="text-align: center;">TZAFREER</p>	<p style="text-align: center;">ABUS</p>	<p style="text-align: center;">BATU-KUNERT</p>	<p style="text-align: center;">ABUS CHAVO ESCO ESSENDIA ITO GEFI GETE GTV NB SCHUCO STANDARD</p>

<b>PARA: FOR: CISA</b>			
<p style="text-align: center;">JPM</p>	<p style="text-align: center;">ABUS-ASTRAL-BRICARD</p>	<p style="text-align: center;">LAT.</p>	

Copyright by  
Alejandro Altuna S.A.  
2005

**JMA**

29









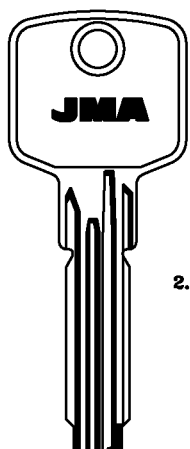

**PARA-FOR:**

**PARA: FOR:**

**CISA**

**CISA (I)**

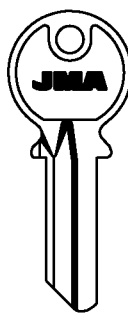
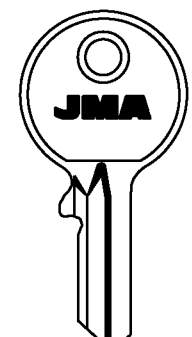
LAT.











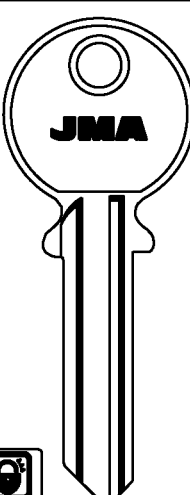
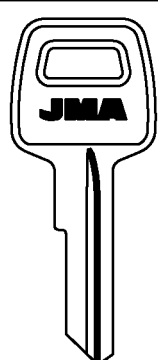

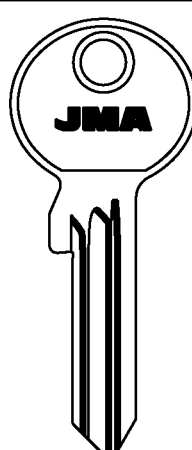





ABUS-ASTRAL-AXIS

ABUS

**PARA: FOR:**

**CISA**

CI-24

CI-28D

CI-41

CI-43D

ABUS

**PARA: FOR:**

**CISA**

LAT.

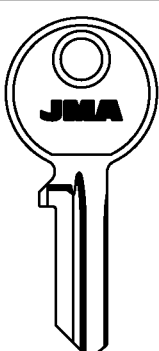
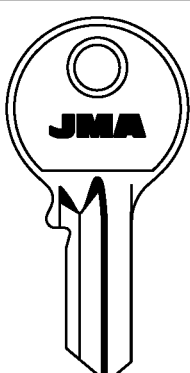
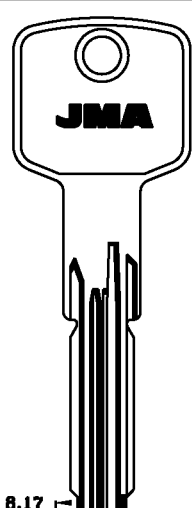
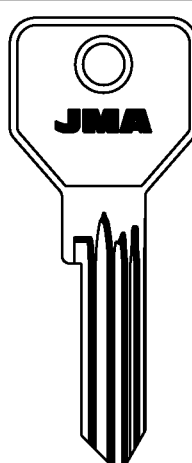
CI-45D

CI-46D

CI-48

CI-49

ABUS

Copyright by  
Alejandro Altuna S.A.  
2005

**JMA**

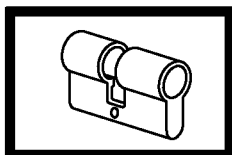

**30**

ATENCION:Concerniente a las marcas y denominaciones comerciales ver nota en indice.ATTENTION:Concerning the marks and commercial denominations see note in Index.  
ATTENTION:Concernant les marques et denominations commerciales voir la note dans l'Index.ACHTUNG:Beziehen auf die marke und handelsname sehen sie die notiz im Index.

**PARA:** CISA  
**FOR:**

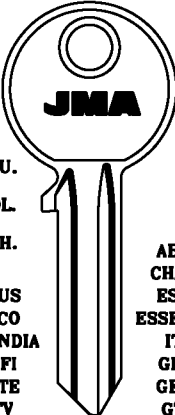

ALU.  
COL.  
• FSH.  
ABUS  
ESCO  
ESSENDIA  
GEFI  
GETE  
GTV  
NB  
SCHUCO  
STANDARD

ABUS  
CHAVO  
ESCO  
ESSENDIA  
ITO  
GEFI  
GETE  
GTV  
NB  
SCHUCO  
STANDARD

50-60

CI-21  
A  
CI-2  
02  
CI-8D  
20  
CI-9D  
08  
CI-10D  
04-05-07  
CI-11D  
11  
CI-12  
33  
CI-13

CI-15  
CI-15D  
CI-16D  
CI-18  
CI-27  
CI-29  
CI-34  
CI-36  
CI-38D

CLAUZOR

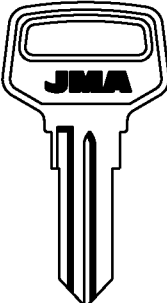

ALU.

CL-11

BRABANTIA

**PARA-FOR:**

CISA (I)  
CLAUZOR (E)  
CLEMSA (E)  
COM (D)  
CORBIN (I)

**PARA:** CLEMSA  
**FOR:**

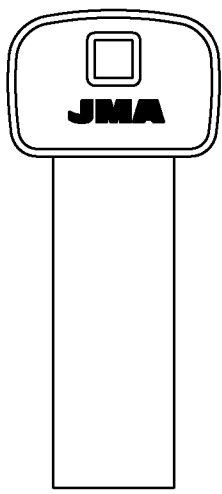
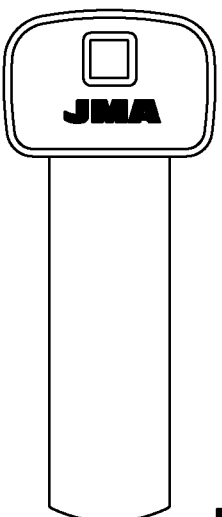
PLAS. PLAS.

MG-6I MG-6S MG-6D MG-9

COM

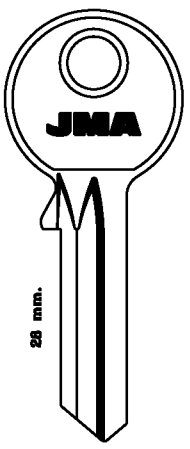

28 mm.

COM-1D

**PARA:** CORBIN  
**FOR:**

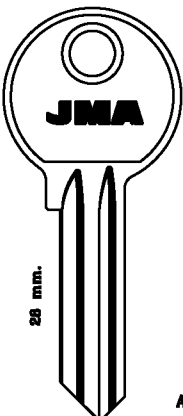

28 mm.

ALUNORM  
CRC-CAMBOA  
DOM  
ESCO  
EURONORM  
HEGO  
HESTE  
ISSERSTEDT  
KAWE  
LITTO  
MERMIER  
MUKRA  
NEMEF  
NOVOFERM  
STREMLER  
SUL  
THONE  
VERSCO  
ZECE

COR-18D  
COR-19D  
COR-21D  
COR-22D  
COR-36D

ALU.

COR-11 COR-1D COR-48  
COR-3 COR-3D COR-49

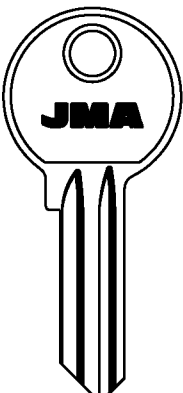

COR-21 COR-2D  
COR-16D

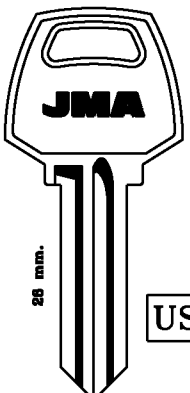

28 mm.

USA

COR-7  
COR-8

ESCO-KAWE-LITTO-NEMEF

Copyright by  
Alejandro Altuna S.A.  
2005

JMA

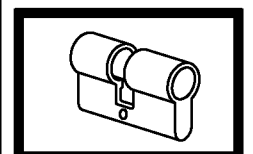

31

**PARA-FOR:**

**CORBIN (I)**

**PARA: CORBIN**  
**FOR:**

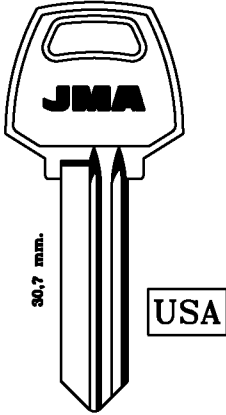

30,7 mm. USA

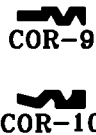

COR-9



COR-11



COR-11D

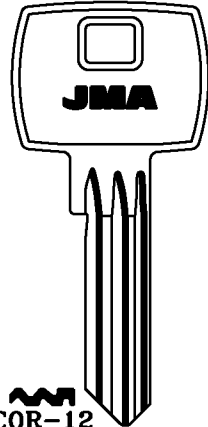

COR-12

1 AL 9  
0 AL 8  
2 AL 8



COR-13



COR-13D

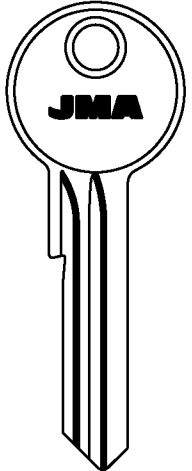

COR-15D

MASTER      EUROPARTNER

**PARA: CORBIN**  
**FOR:**



COR-17D



COR-20



COR-20D

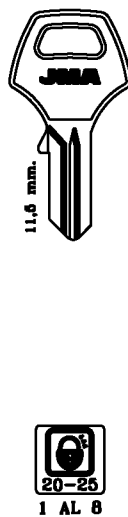

11,6 mm.

20-25  
1 AL 8

COR-20/25

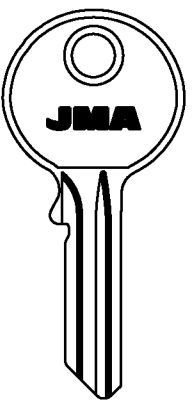

COR-23D

**PARA: CORBIN**  
**FOR:**

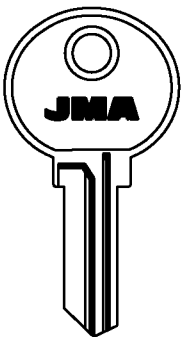

COR-24

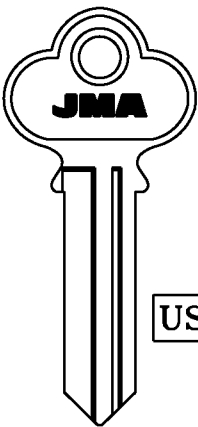

COR-25I



COR-25

USA

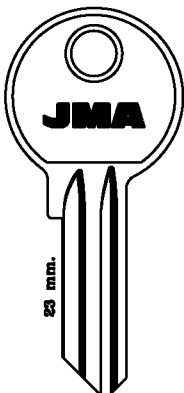

23 mm.

.....1 AL 7  
.....2 AL 7

COR-26



21 mm.

COR-27D

CHANGE-O-MATIC      SKILMANN      ESCO-EURONORM-KAWE-MUKRA

Copyright by  
Alejandro Altuna S.A.  
2005

**JMA**

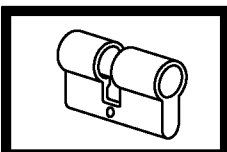

**32**

PARA:  
FOR:

### CORBIN

**PARA-FOR:**

**CORBIN (I)**

**CORONA (D)**

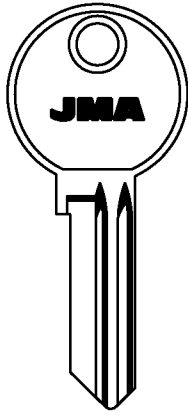

COR-28

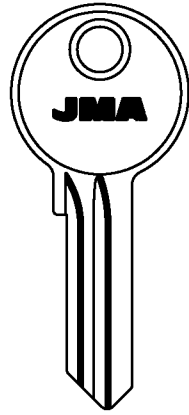

COR-29D

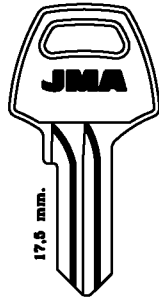

1 AL 9  
1 AL 7  
2 AL 7

COR-30

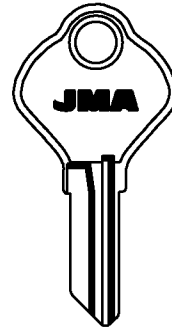

COR-31

CCL

PARA:  
FOR:

### CORBIN

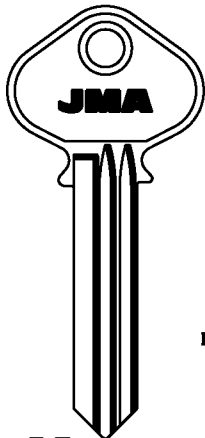

COR-32

LAT.

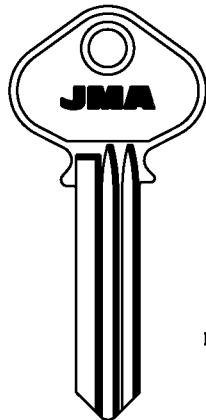

COR-34

LAT. LAT.

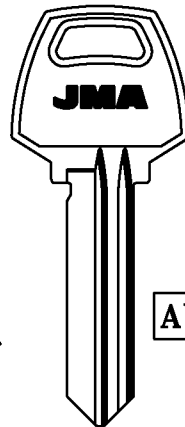

COR-35

AUS

LANE

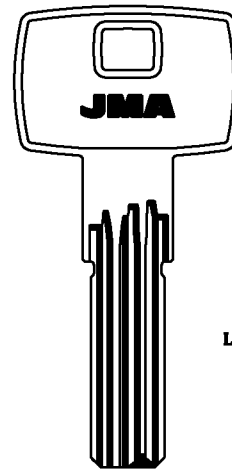

COR-37

LAT.

PARA:  
FOR:

### CORBIN

### CORONA

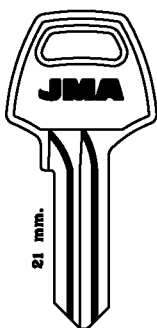

1 AL 9  
1 AL 7  
2 AL 7

COR-40

OAL

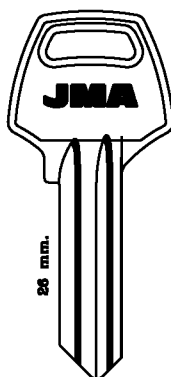

2 AL 9  
1 AL 9

COR-50/60I COR-50/60

MERMIER-OAL

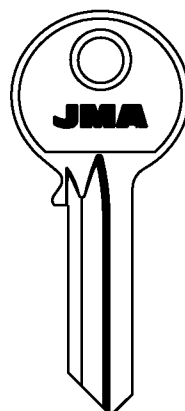

COL.

CO-1D

BAB-BURG-DOCO-GEBRO-IKON

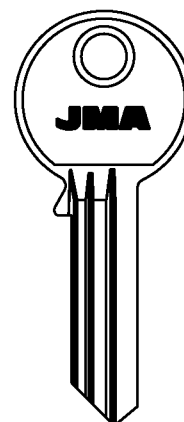

CO-M

IKON

Copyright by  
Alejandro Altuna S.A.  
2005

# JMA

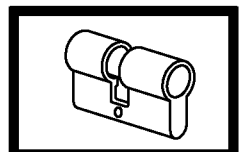

## 33

**PARA-FOR:**

**COTICO (D)**







**CUBELLS (E)**



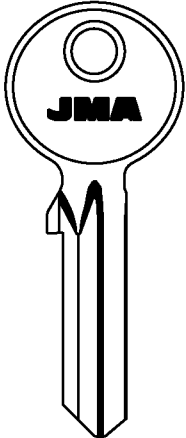
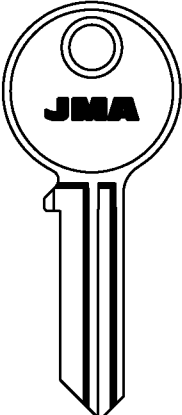
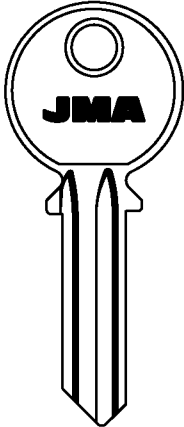
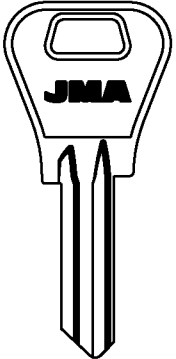



**CVL (E)**



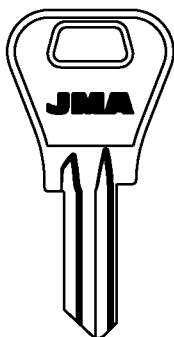
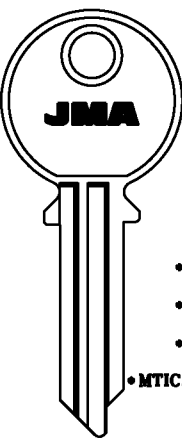
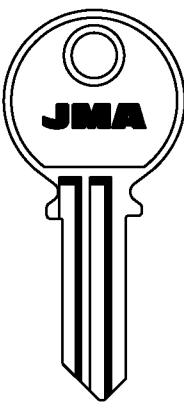
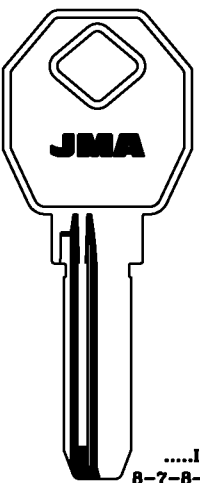



**DAD (F)**

**DEFA (N)**

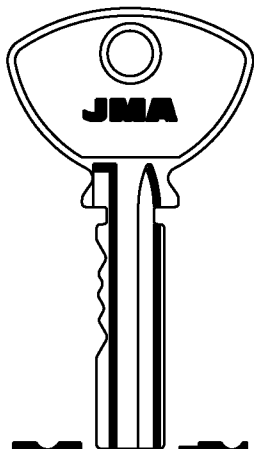
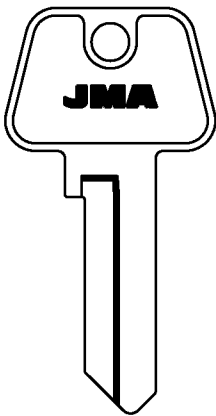
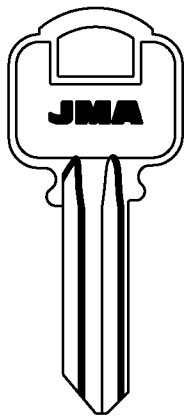
**DEKABA (BG)**

PARA: FOR:	COTICO	CUBELLS	CVL	
				
			 	 
			SERRALLER	UCEM

PARA: FOR:	CVL			
				
		  		
		• FSH. • LAT. • ALU. • MTIC.(D-C)		ALP. .....IC 8-7-8-5-4-3 8.9 2.4
		AUMON-CAYS-CAZORLA-EURO FERMOD-JJ-PP-QCM		







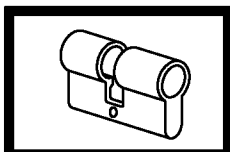



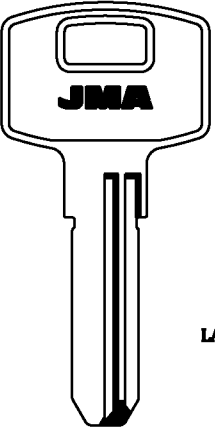
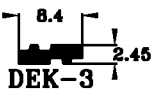

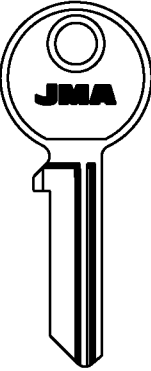

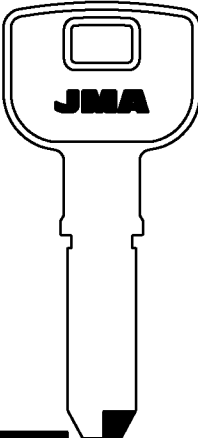
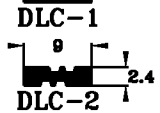
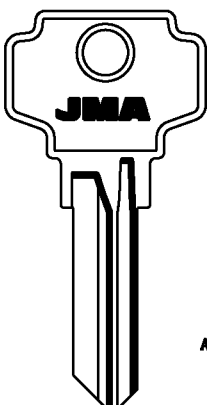
PARA: FOR:	DAD	DEFA	DEKABA
			
	 		
	 		
	DECAVEUX		

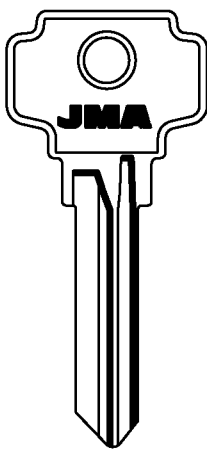
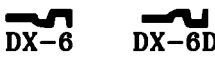
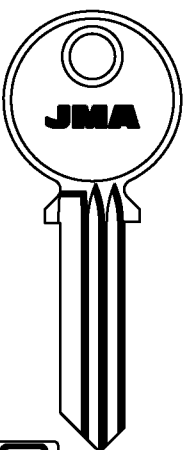
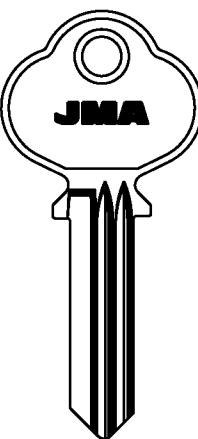
Copyright by  
Alejandro Altuna S.A.  
2005

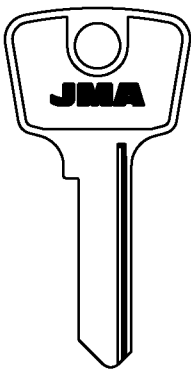
**JMA**

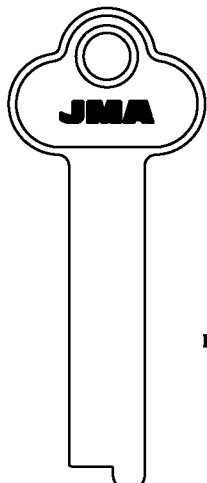

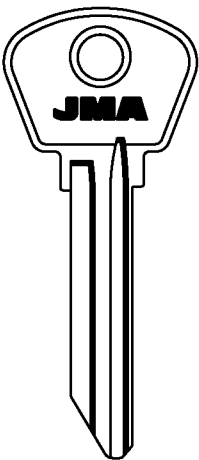
**34**

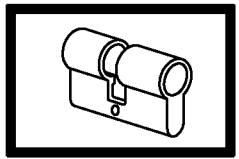
<p><b>PARA:</b> DEKABA <b>FOR:</b></p>  <p>LAT.</p>  <p>DEK-3</p>	<p><b>DELAPORTE</b></p>    <p>2501-2550 DLP-1</p>  <p>DLP-2</p>	<p><b>DELCA</b></p>  <p>LAT</p>  <p>DLC-1 DLC-2</p> <p>GEVY</p>	<p><b>PARA-FOR:</b></p> <p><b>DEKABA (BG)</b></p> <p><b>DELAPORTE (F)</b></p> <p><b>DELCA (GR)</b></p> <p><b>DEXTER (I)</b></p> <p><b>DIAMOND (RC)</b></p> <p><b>DIEBOLD (D)</b></p> <p><b>DIMITROVGRAD (RUS)</b></p>	
<p><b>PARA:</b> DEXTER <b>FOR:</b></p>  <p>ALU.</p> <p>0 AL 7 T 0 AL 9 0 AL 9</p>  <p>DX-5 DX-5D</p>  <p>0 AL 7 0 AL 9</p>  <p>DX-6 DX-6D</p>		<p><b>DIAMOND</b></p>    <p>DIA-1</p>  <p>DIA-2</p>		<p><b>DOM (D)</b></p>
<p><b>PARA:</b> DIAMOND <b>FOR:</b></p>   <p>DIA-3</p>	<p><b>DIEBOLD</b></p>  <p>LAT.</p>  <p>DIE-1</p>	<p><b>DIMITROVGRAD</b></p>   <p>DM-1</p>	<p><b>DOM</b></p> <p>BTV DAD ESAFE FECOR HAEPELE HEKNA HUWIL MECALUX METEOR MLM RENZ RUKA SCHLEGEL STS</p> <p>• ALU. • LAT. • FSH.</p> <p>18 mm.</p> <p>2D 001-222 5A 0001-2800 9A 0001-5200 1D 601-654</p> <p>DOM-11 • DOM-1D</p>	<p>Copyright by Alejandro Altuna S.A. 2005</p>   <p><b>35</b></p>

ATTENTION: Concerning the marks and commercial denominations see note in index. ATTENTION: Concerning the marks and commercial denominations see note in index. ATTENTION: Concerning the marks and commercial denominations see note in index. ATTENTION: Concerning the marks and commercial denominations see note in index.

**PARA-FOR:**

**DOM (D)**

**PARA:  
FOR:**

**DOM**

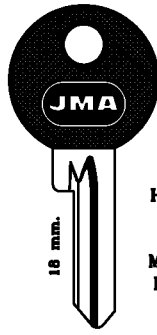

18 mm.

BTV  
DAD  
ESAFE  
FECOR  
HAEFELE  
HEKNA  
HUWIL  
MECALUX  
METEOR  
MLM  
RENZ  
RUKA  
SCHLEGEL  
STS

2D 001-222  
5A 0001-2600  
9A 0001-5200  
1D 801-854

DOM-1D.P

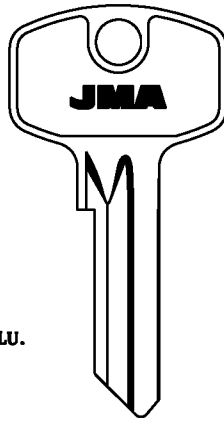

ALU.

HB  
 DOM-2D

MOREAUX-STUV

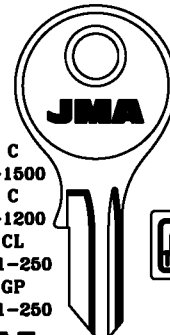

C  
1301-1500  
C  
1001-1200  
CL  
001-250  
GP  
001-250

DOM-3I

DOM-4



DOM-3D

DOM-4D

DOM-8D

CHRIST

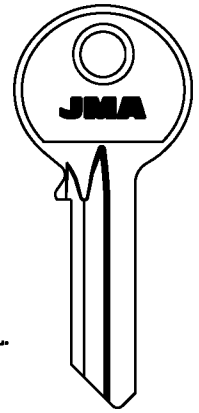

COL.

DOM-5D

STEIGA-STUV-VIKI

**PARA:  
FOR:**

**DOM**

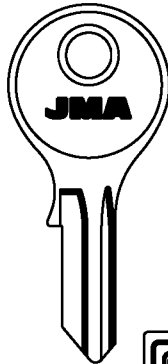

DN  
001-120  
80138-80728  
60761-83242

DOM-6I

BARRO-IDEAL-TM

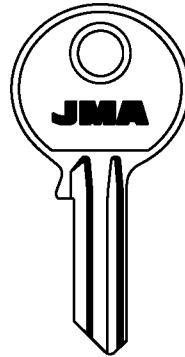

DOM-7I

HOHRMANN



DOM-9

NOBO

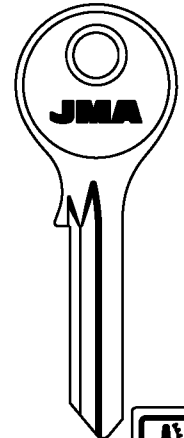

EV....1-2840  
GS....1-1000  
FT....1-1000  
CQ....301-400  
....1-1000

DOM-9D

DOM-38D



DOM-10D

**PARA:  
FOR:**

**DOM**

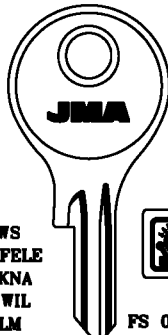

CWS  
HAEFELE  
HEKNA  
HUWIL  
MLM  
MENOVA  
METEOR  
RUKA  
SINJET  
STS

1D 058-114

DOM-11I

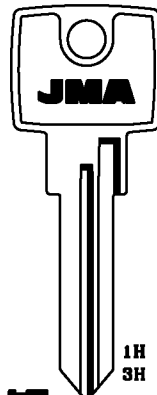

1H 0001-4088  
3H 0001-0800

DOM-12

DOM-12D

1H 0001-4088  
3H 0001-0800

DOM-48

NOBO

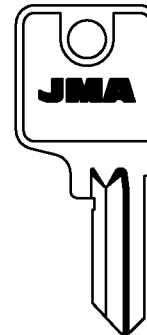

DOM-13D

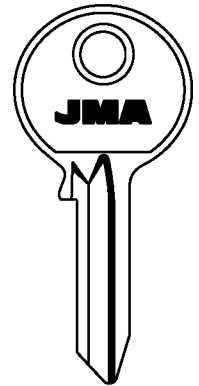

FA-GZ  
0001-3948

DOM-14D

Copyright by  
Alejandro Altuna S.A.  
2005

**JMA**

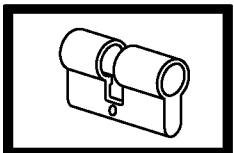

**36**

PARA:  
FOR:

DOM

**PARA-FOR:**

**DOM (D)**

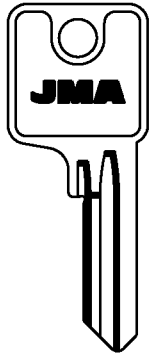

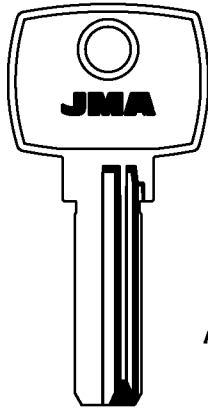

 DOM-15D

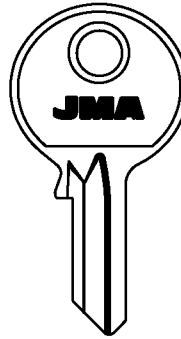

ALP.



 DOM-16D

 DOM-41D

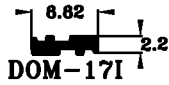

DOM-17I

CORBIN-EMHART

 DOM-18D

PARA:  
FOR:

DOM

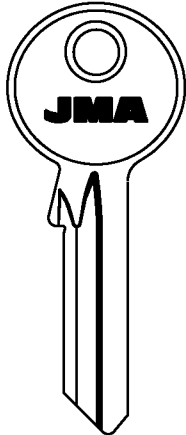

 DOM-20D

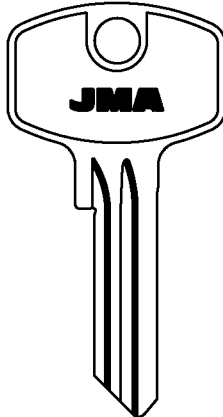

 DOM-21D

CORBIN

 DOM-46D

 DOM-45

 DOM-44D

PARA:  
FOR:

DOM

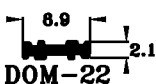
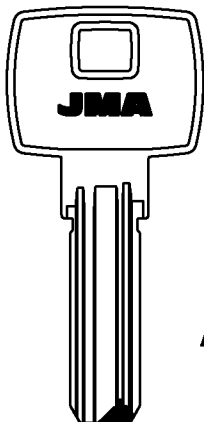

DOM-22

ALP.

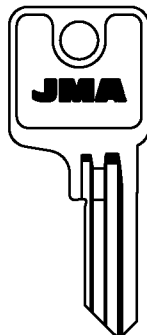

 DOM-25D

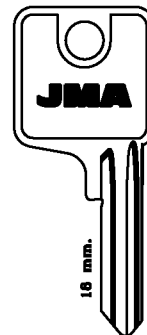

 DOM-26  DOM-26D

2D 001-222  
5A 0001-2800  
9A 0001-5200  
1D 801-854

Copyright by  
Alejandro Altuna S.A.  
2005

**JMA**

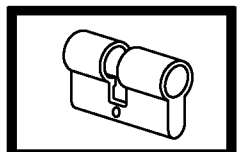

**PARA-FOR:**

PARA:  
FOR:

**DOM**

**DOM (D)**

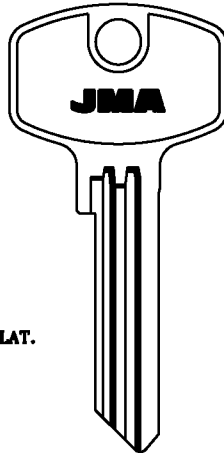

LAT.

- DOM-27D/2       DOM-27D/9       DOM-27D/16       DOM-27D/23       DOM-27D/30
- DOM-27D/3       DOM-27D/10       DOM-27D/17       DOM-27D/24       DOM-27D/31
- DOM-27D/4       DOM-27D/11       DOM-27D/18       DOM-27D/25       DOM-27D/32
- DOM-27D/5       DOM-27D/12       DOM-27D/19       DOM-27D/26       DOM-27D/33
- DOM-27D/6       DOM-27D/13       DOM-27D/20       DOM-27D/27       DOM-27D/34
- DOM-27D/7       DOM-27D/14       DOM-27D/21       DOM-27D/28       DOM-27D/35
- DOM-27D/1       DOM-27D/8       DOM-27D/15       DOM-27D/22       DOM-27D/29       DOM-27D/36
  
- DOM-27D/37       DOM-27D/44       DOM-27D/51       DOM-27D/58
- DOM-27D/38       DOM-27D/45       DOM-27D/52       DOM-27D/59
- DOM-27D/39       DOM-27D/46       DOM-27D/53       DOM-27D/60
- DOM-27D/40       DOM-27D/47       DOM-27D/54       DOM-27D/61
- DOM-27D/41       DOM-27D/48       DOM-27D/55
- DOM-27D/42       DOM-27D/49       DOM-27D/56
- DOM-27D/43       DOM-27D/50       DOM-27D/57

PARA:  
FOR:

**DOM**

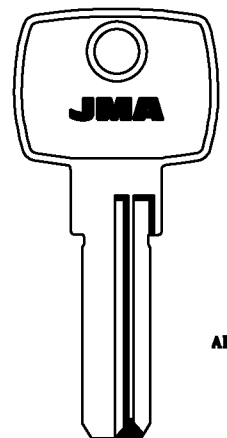
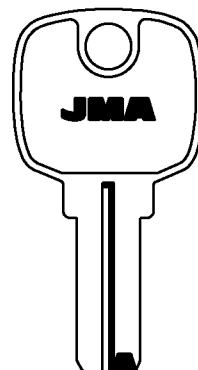
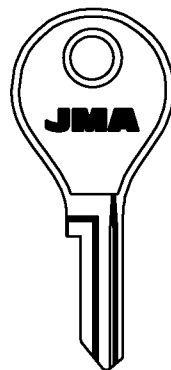
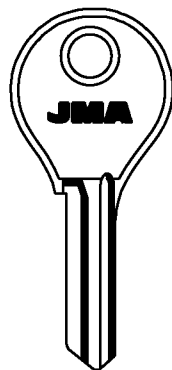

ALP.

ALP.

DOM-28

6E...1-205  
 DOM-29

EA0

8.4 2.4  
DOM-30

MOREAUX

8.9 IX 5 2.35  
DOM-31

CORBIN-EMHART

Copyright by  
Alejandro Altuna S.A.  
2005

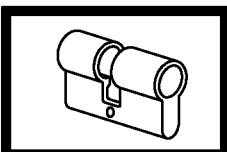

**38**

PARA:  
FOR:

DOM

PARA-FOR:

DOM (D)

DOMINION  
(USA)

DOMUS (I)

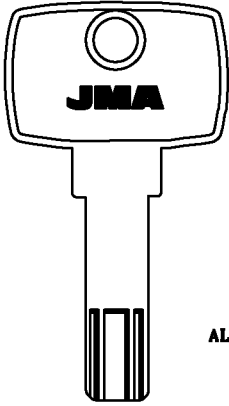

ALP.

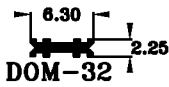

DOM-32

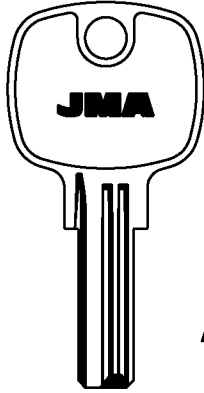

ALP.

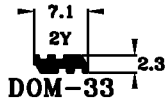

DOM-33

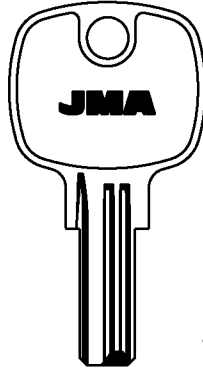

ALP.

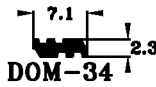

DOM-34

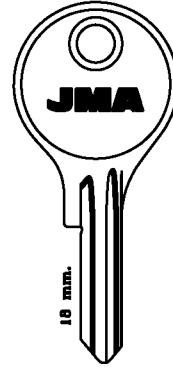

16 mm.

2D 001-222  
5A 0001-2800  
9A 0001-5200  
1D 601-654

DOM-35 DOM-35D

CORBIN-EMHART

PARA:  
FOR:

DOM

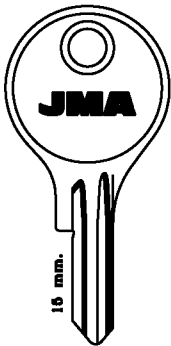

16 mm.

2D 001-222  
5A 0001-2800  
9A 0001-5200  
1D 601-654

DOM-36 DOM-36D

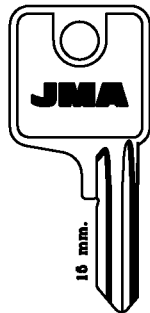

16 mm.

2D 001-222  
5A 0001-2800  
9A 0001-5200  
1D 601-654

DOM-37 DOM-37D

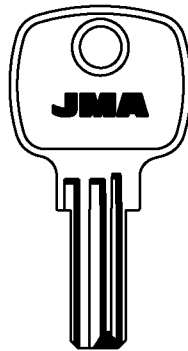

ALP.

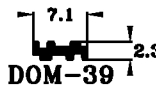

DOM-39

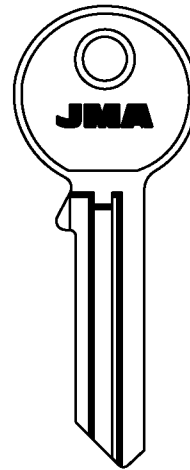

DOM-40D

PARA:  
FOR:

DOM

DOMINION

DOMUS



DOM-42  
FLAMBO-HEKNA-NOBO  
PEROHAUS

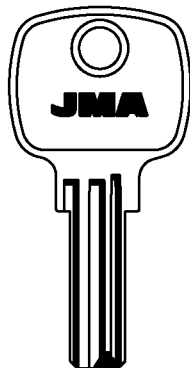

ALP.

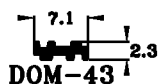

DOM-43



LAT.

DOI-1

PETERBORO

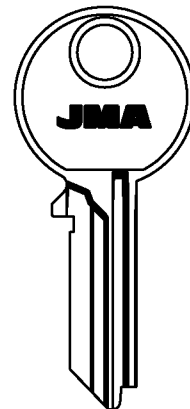

DO-2I

Copyright by  
Alejandro Altuna S.A.  
2005

JMA

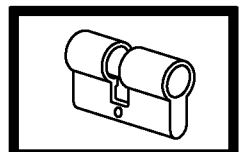

39

**PARA-FOR:**

**DOMUS (I-GR)**

**DOUBLE CIRCLE (RC)**

**DURALOCK (USA)**





**EAG (D)**





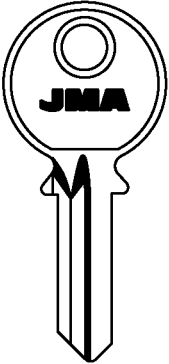
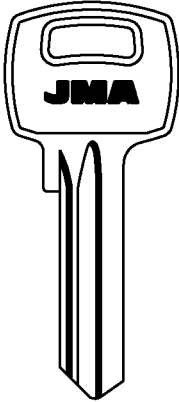
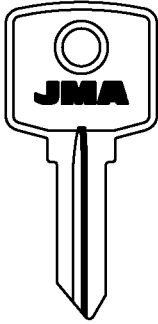
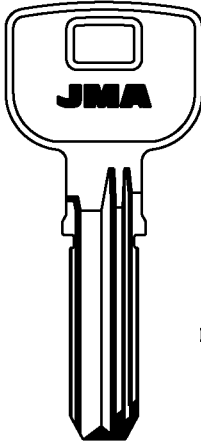
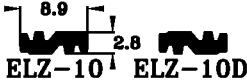
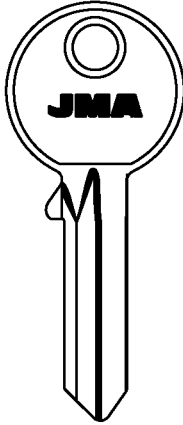
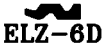

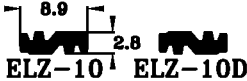
**ECM (I)**



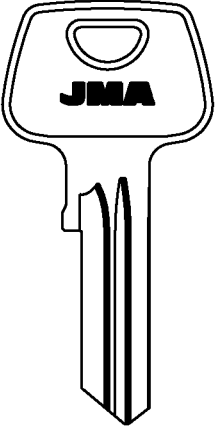

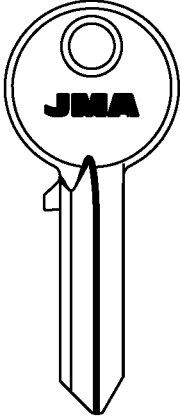
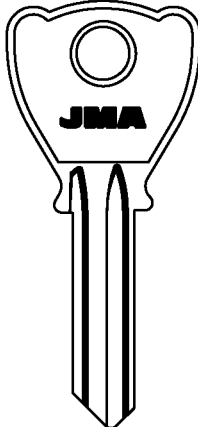
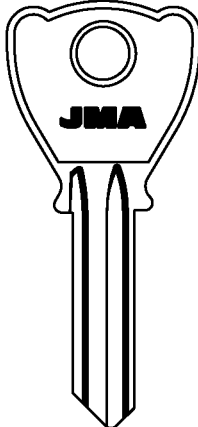
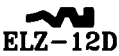

**EIKO (J)**

**ELZETT (H)**

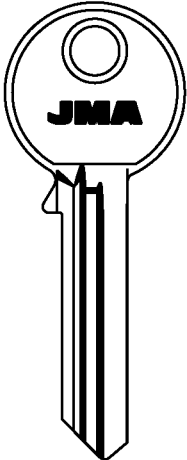
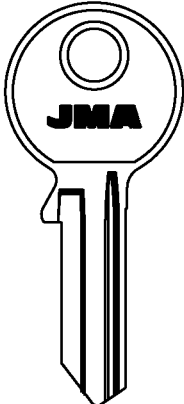
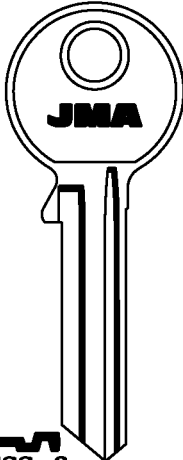
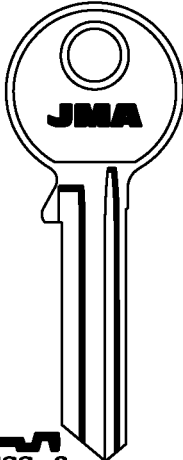
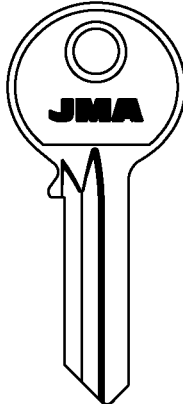
<p>PARA: FOR:</p>	<p>DOMUS</p>		<p>DOUBLE CIRCLE</p>	
	<p>PARA: FOR: D. CIRCLE</p>	<p>DURALOCK</p>	<p>EAG</p>	<p>ECM</p>
	<p>PARA: FOR: EIKO</p>		<p>ELZETT</p>	
	<p>Copyright by Alejandro Altuna S.A. 2005</p> <p><b>40</b></p>			

<b>PARA: FOR:</b>	<b>ELZETT</b>					<b>PARA-FOR:</b>
						<b>ELZETT (H)</b>
						<b>EMKA (F)</b>
			LAT.			<b>ERA (GB)</b>
						<b>ESA (E)</b>
						<b>ESLA (GB)</b>
						<b>ESS (D)</b>
						<b>ETAS (GB)</b>

<b>PARA: FOR:</b>	<b>ELZETT</b>	<b>EMKA</b>	<b>ERA</b>	<b>ESA</b>
				
				
			NUMIDA	

<b>PARA: FOR:</b>	<b>ESLA</b>	<b>ESS</b>		<b>ETAS</b>
				
				
				YANEDIS

Copyright by  
Alejandro Altuna S.A.  
2005

**JMA**

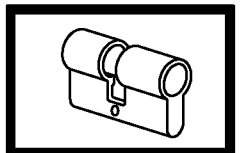

ATENCION:Concerniente a las marcas y denominaciones comerciales ver nota en indice.ATTENTION:Concerning the marks and commercial denominations see note in index.  
ATTENTION:Concernant les marques et denominations commerciales voir la note dans l'index.ACHTUNG:Beziehen auf die marke und handelsname sehen sie die notiz im index.

**PARA-FOR:**

**PARA:** EUREKA  
**FOR:**



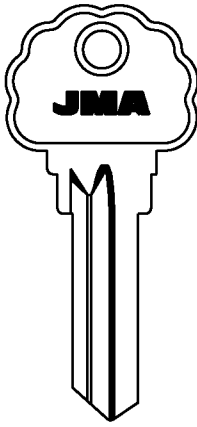
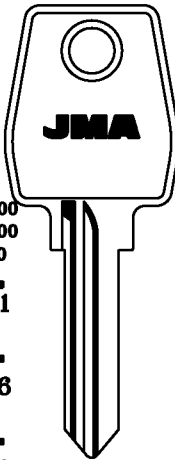
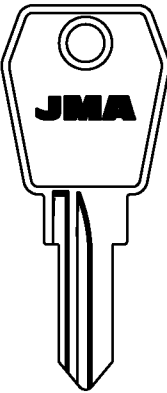
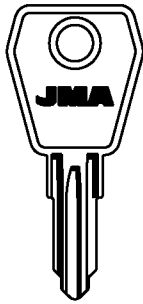
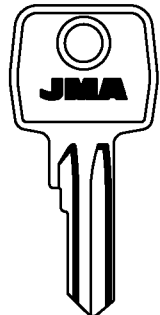
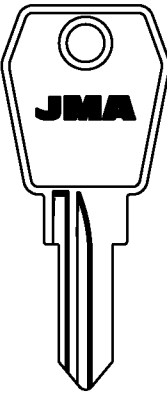
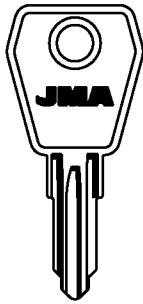
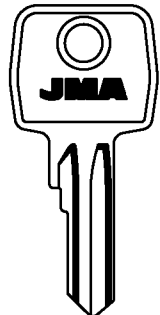
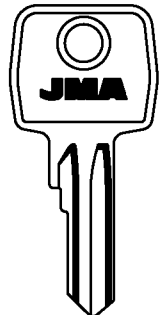

**EUROLOCKS**

- EUREKA (D)**
- EUROLOCKS (B)**
- EVERGOOD (RC)**
- EVVA (A)**



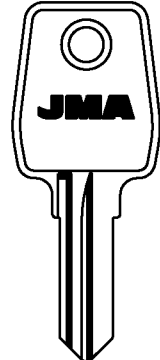

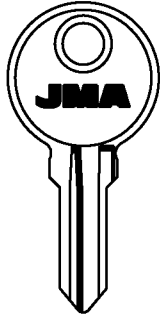
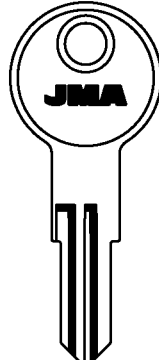
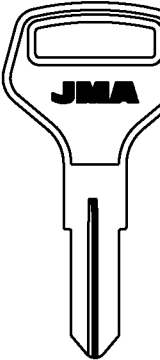
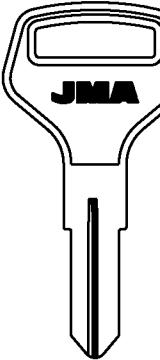





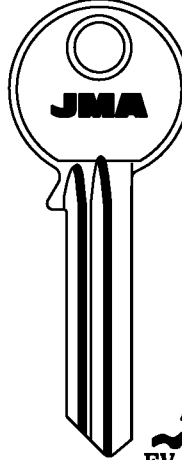
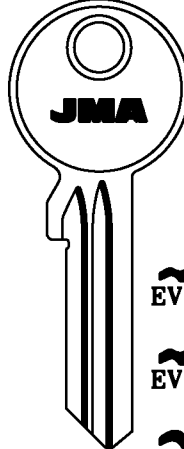
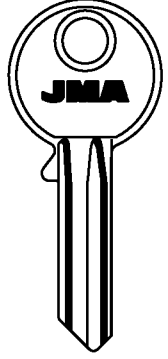

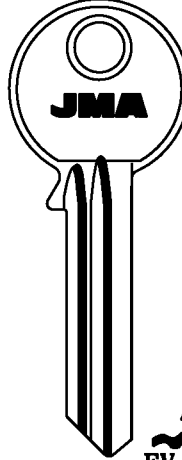
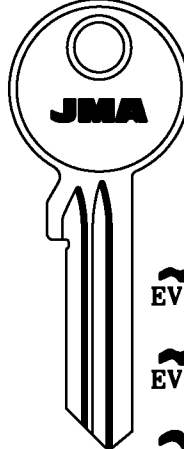

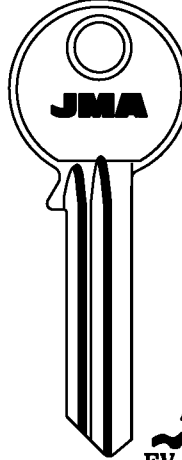
 <b>EUR-1D</b>	<p>47001-48000 45000-47000 1201-1400</p>  <b>EU-1</b>	 <b>EU-6</b>	 <b>EU-9</b>	 <b>EU-10D</b>
	<p>25001-27000</p>  <b>EU-2</b>	 <b>EU-3</b>	<p>.... ...A 458-5124</p>  <b>EU-4</b>	<p>.... ...E 405-4324</p>  <b>EU-4D</b>

**PARA:** EUROLOCKS  
**FOR:**

**EVERGOOD**

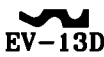
 <b>EU-7</b>	 <b>EU-7D</b>	 <b>EU-8D</b>	 <b>EVE-1</b>	 <b>EVE-1D</b>	 <b>EVE-2D</b>	 <b>EVE-3D</b>
 <b>L&amp;F-RENZ</b>						

**PARA:** EVVA  
**FOR:**

 <b>EV-2I</b>	 <b>EV-2</b>	 <b>EV-8D</b>	 <b>EV-11D</b>
<p>2C</p>  <b>EV-2I</b>	<p>A</p>  <b>EV-1</b>	<p>C</p>  <b>EV-2</b>	<p>A</p>  <b>EV-8D</b>
<p>2F</p>  <b>EV-3I</b>	<p>C</p>  <b>EV-2</b>	<p>F</p>  <b>EV-7D</b>	
 <b>EV-3I</b>	<p>F</p>  <b>EV-3D</b>	<p>A</p>  <b>EV-4D</b>	<p>S</p>  <b>EV-9D</b>
 <b>EV-13D</b>	 <b>EV-10</b>	<p>K0</p>  <b>EV-11</b>	<p>K1</p>  <b>EV-11D</b>
<p>....101-1479</p>		<p>....2001-2479</p>	
<p><b>ELCA</b></p>		<p><b>ELCA</b></p>	

Copyright by  
Alejandro Altuna S.A.  
2005

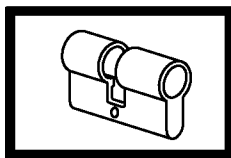
**42**

ATENCION:Concerniente a las marcas y denominaciones comerciales ver nota en indice.ATTENTION:Concerning the marks and commercial denominations see note in index. ATTENTION:Concernant les marques et denominations commerciales voir la note dans l'index.ACHTUNG:Beziehen auf die marke und handelsname sehen sie die notiz im index.

<b>PARA: FOR:</b> EVVA	<b>EXCEL</b>	<b>EZCURRA</b>	
 LAT. EV-12D	 EX-1D SIDLEEN	 • ALU. • LAT. • FSH. EZ-1I	 EZ-2I

**PARA-FOR:**

**EVVA (A)**

**EXCEL (F)**

**EZCURRA (E)**

**FAB (CZ)**

<b>PARA: FOR:</b> EZCURRA			
 EZ-3I	 EZ-3D	 EZ-4I	 EZ-4D
		 ALP. 7.45 2.3 EZ-DS10 CAS EZ-DS10E	 LAT. 7.45 2.3 EZ-DS15 EZ-DS15R

<b>PARA: FOR:</b> FAB			
	 8 FB-3	 13 FB-22	 24 FB-9
 9 FB-19	 14 FB-23	 11X FB-11	 28 FB-10
 10 FB-20	 15 FB-24	 FB-5	 30 FB-11
 11 FB-21	 16 FB-25	 20 FB-6	 32 FB-12
 12 FB-21	 16 FB-25	 21 FB-7	 12X FB-26
 16 FB-25	 16 FB-25	 23 FB-8	 23 FB-29
 16 FB-25	 16 FB-25	 22 FB-2I	
 16 FB-25	 16 FB-25	 22 FB-2I	

Copyright by  
Alejandro Altuna S.A.  
2005

**JMA**

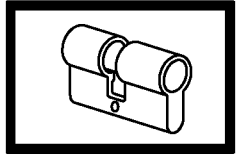

ATENCION:Concerniente a las marcas y denominaciones comerciales ver nota en indice.ATTENTION:Concerning the marks and commercial denominations see note in index.  
ATTENTION:Concernant les marques et denominations commerciales voir la note dans l'index.ACHTUNG:Beziehen auf die marke und handelsname sehen sie die notiz im index.

**PARA-FOR:**

**FAB (CZ)**

**FAC (E)**

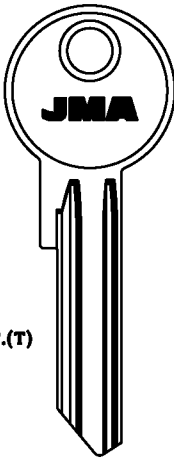
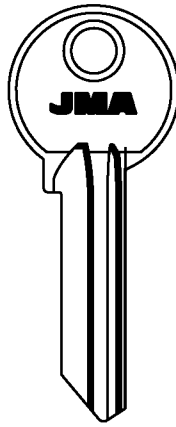
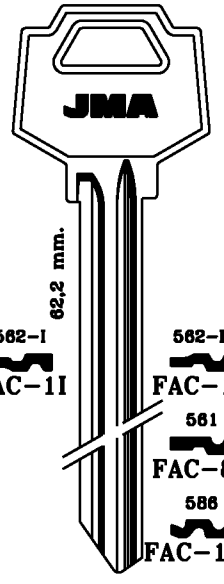
PARA: FOR:	FAB	FAC
 <p>• MTIC.(T)</p>	 <p>                     PR30 • FB-17                      PR23 FB-14 PR32 FB-18 10X FB-32                      PR24 FB-15 PR20 • FB-27 12X FB-34                      PR22 • FB-13 PR26 FB-16 PR21 FB-28 11X FB-35                      FB-33                 </p>	 <p>62,2 mm.</p> <p>582-I FAC-11 582-D FAC-1D 581 FAC-8D 586 FAC-12D</p>

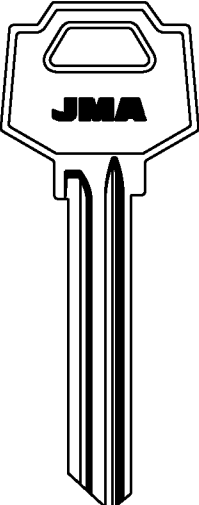
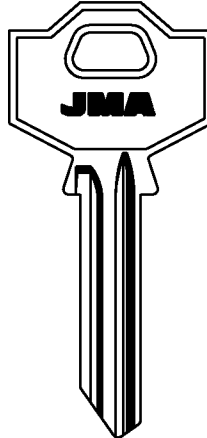
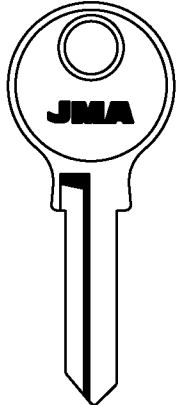
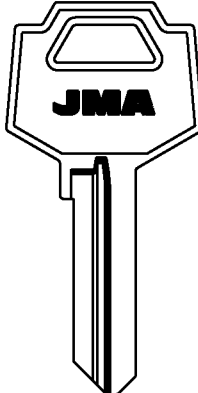
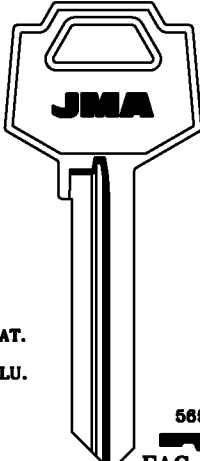
PARA: FOR:	FAC					
 <p>FAC-21</p>	 <p>FAC-2D</p>	 <p>FAC-3I</p>	 <p>FAC-3D</p>	 <p>FAC-4D</p>	<p>LAT. ALU.</p> <p>558 FAC-5D 583 FAC-9D</p>	<p>565 FAC-6D 571 FAC-10D</p>

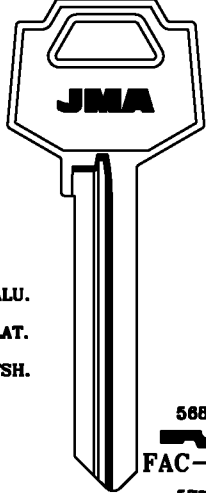
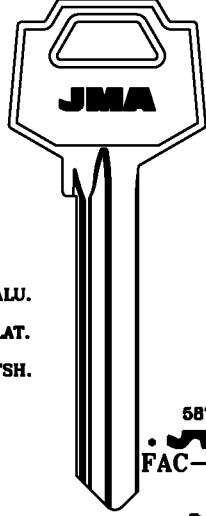
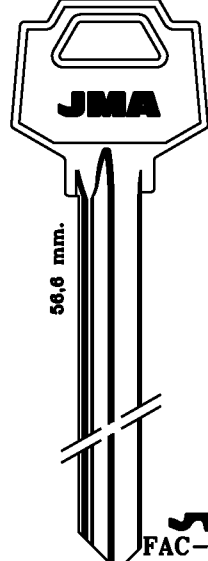
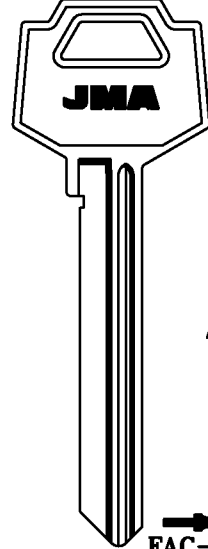
PARA: FOR:	FAC		
 <p>• ALU. • LAT. • FSH.</p> <p>568 FAC-7D 577 • FAC-11D</p>	 <p>• ALU. • LAT. • FSH.</p> <p>587 • FAC-13D FAC-15</p>	 <p>56,6 mm.</p> <p>FAC-14D</p>	 <p>ALU.</p> <p>FAC-18</p>

Copyright by Alejandro Altuna S.A. 2005

**JMA**

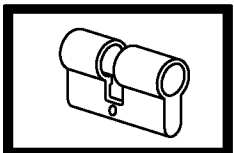

PARA:  
FOR:

FAC

PARA-FOR:

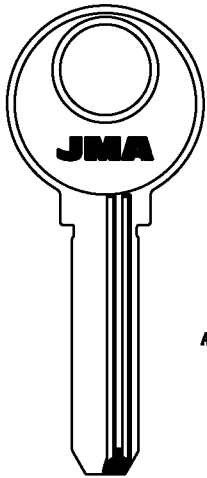

ALP.

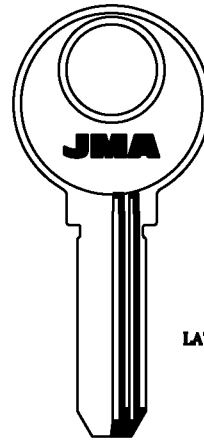
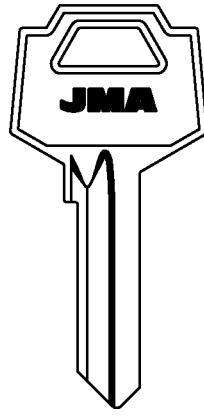
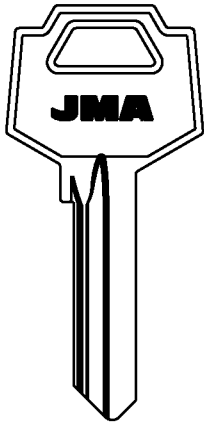

LAT.

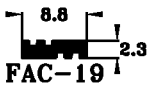

FAC-19

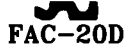

FAC-20D

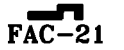

FAC-21

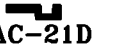

FAC-21D

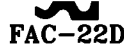

FAC-22D

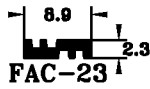

FAC-23

FAC (E)

FAINER (P)

FAMA (BR)

FANA (D)

FAS (S)

FASEM (I)

FAVOUR (DZ)

FCV (D)

PARA:  
FOR: FAINER

FAMA

FANA

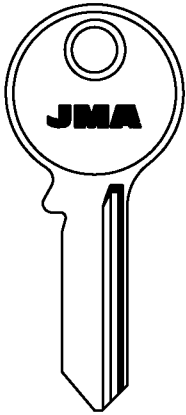

FAIN-1I

SIL

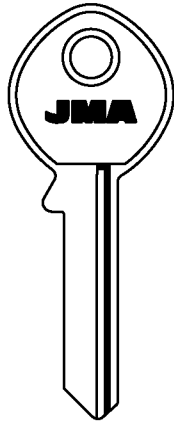

FAM-1



FAM-2

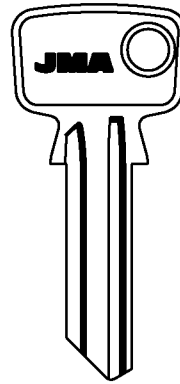

FAN-1

FAN-1D

PARA:  
FOR: FAS

FASEM

FAVOUR

FCV

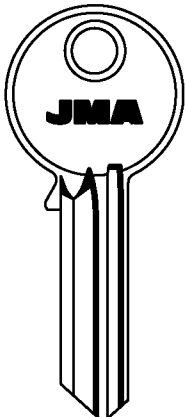

FA-1

FA-1D

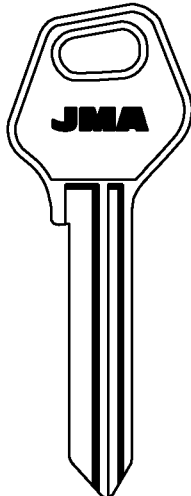

FAS-1



LAT.



FAV-1

FAV-2

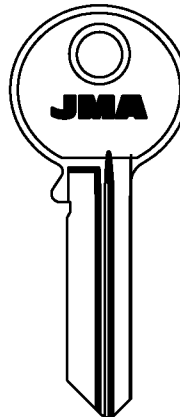

FV-1D

Copyright by  
Alejandro Altuna S.A.  
2005

JMA

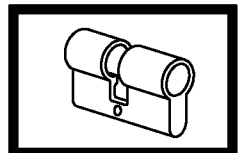







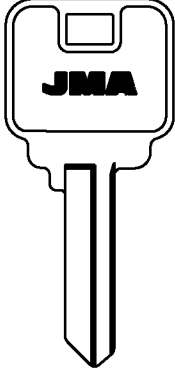
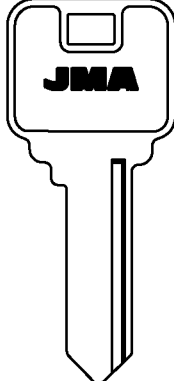
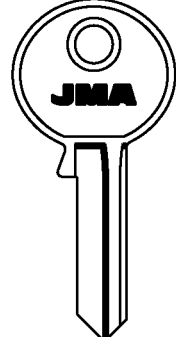
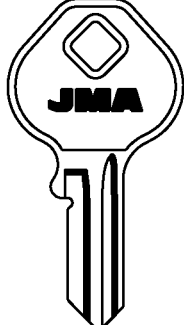
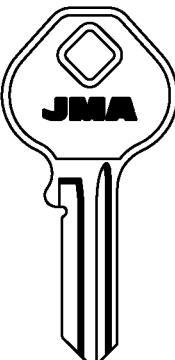

**PARA-FOR:**

**FECHADURA  
(BR)**

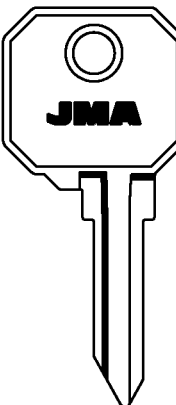
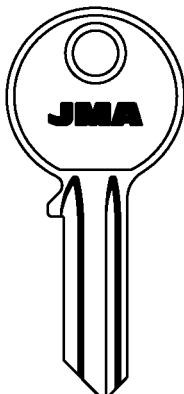
**FEDERAL  
(USA)**

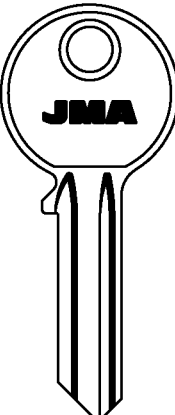
**FERONERIA  
(RU)**

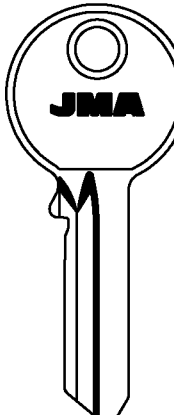
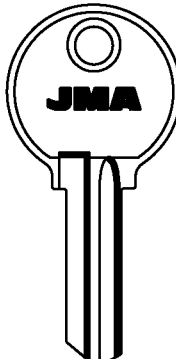
**F.F. (I)**

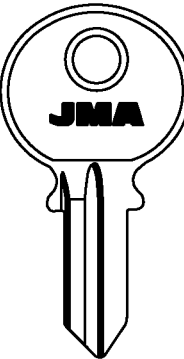



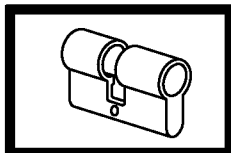

<p>PARA: FOR:</p>	<p><b>FECHADURA</b></p>			<p><b>FEDERAL</b></p>
 <p>FEC-1D</p>  <p>FEC-2 STAM</p>  <p>FEC-3D STAM</p>	 <p>FED-1</p>			
<p>PARA: FOR:</p>	<p><b>FEDERAL</b></p>		<p><b>FERONERIA</b></p>	<p><b>F.F.</b></p>
 <p>FED-2</p>  <p>FED-3</p>	 <p>FER-1</p>		 <p>0 AL 7 FF-1    FF-1D</p>  <p>FF-3 GUARDIAN</p>	
<p>PARA: FOR:</p>	<p><b>F.F.</b></p>			
 <p>0 AL 7 FF-2    FF-2D</p>  <p>FF-10D GUARDIAN</p>  <p>FF-5D</p>  <p>FF-6</p>  <p>FF-11</p>  <p>FF-7D</p>				



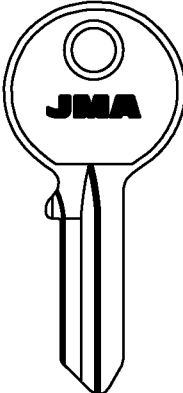
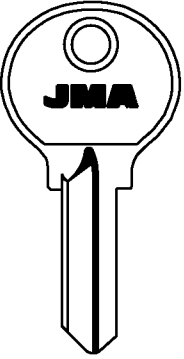

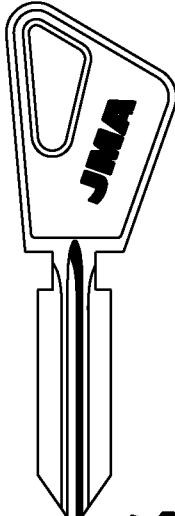

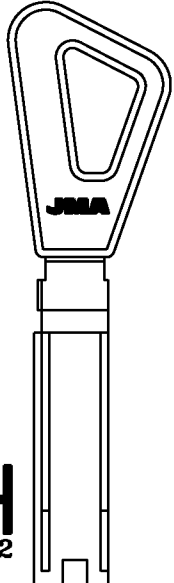

Copyright by  
Alejandro Altuna S.A.  
2005

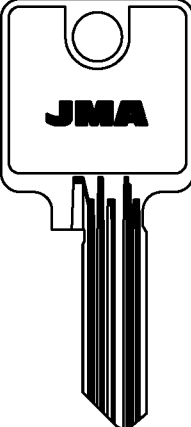

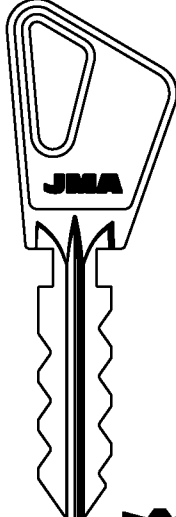

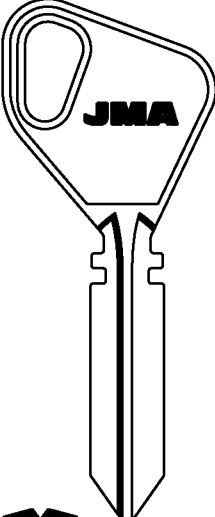

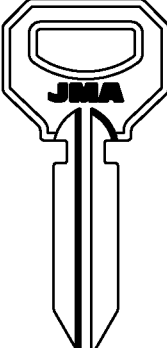

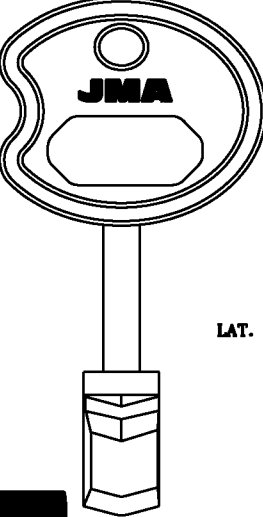

**JMA**

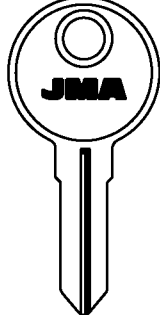

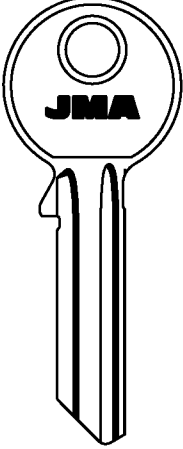
**46**

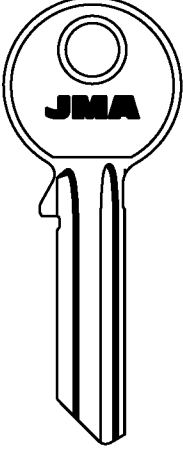
<b>PARA:</b> <b>FOR:</b>	<b>F.F.</b>	<b>FICHET</b>		<b>PARA-FOR:</b>
 	 <b>FF-8D</b>	 <b>FF-9D</b>	  <b>FIC-1</b>	<b>F.F. (I)</b>
		  <b>FIC-2</b>	<b>SURFINOR</b>	<b>FICHET (F)</b>
				<b>FIST (I)</b>
				<b>FLORA (D)</b>
				<b>FONTAINE (F)</b>

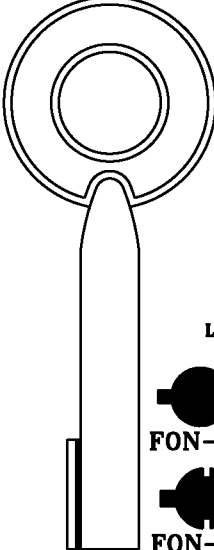
<b>PARA:</b> <b>FOR:</b>	<b>FICHET</b>			
  <b>FIC-5</b>	  <b>FIC-7</b>	  <b>FIC-8</b>	  <b>FIC-9</b>	
	<b>SURFINOR</b>		<b>TECNOR</b>	

<b>PARA:</b> <b>FOR:</b>	<b>FICHET</b>	<b>FIST</b>	<b>FLORA</b>	<b>FONTAINE</b>
  <b>FIC-18</b>	  <b>FIS-1D</b>	  <b>FLO-1</b>	  <b>FLO-1D</b>	  <b>FON-1E</b>
			<b>FLOHR-NB-NORDWEST-SUKI</b>	 <b>FON-6E</b>

Copyright by  
Alejandro Altuna S.A.  
2005

**JMA**

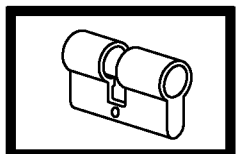

**47**

**PARA-FOR:**









**FONTAINE (F)**

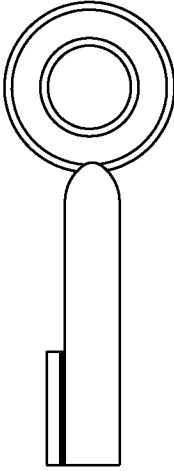



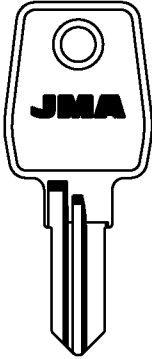
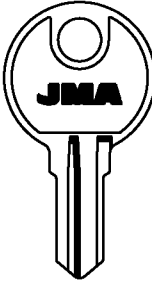



**FORT (F)**

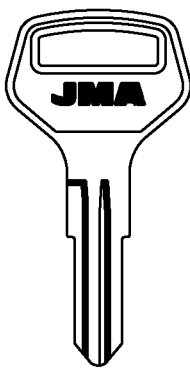
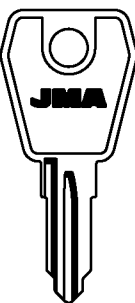





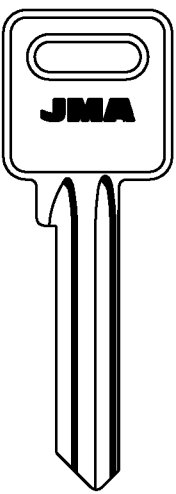

**FORTE (YV)**

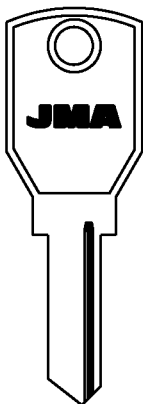
**FORTIS (E)**

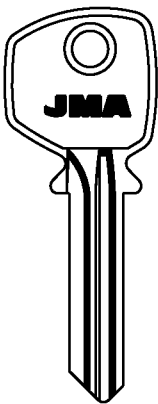
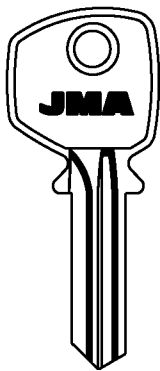
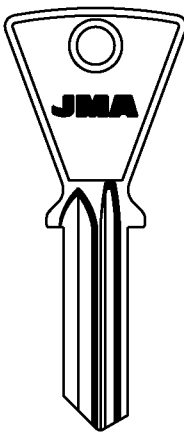
**FTH (F)**

<p><b>PARA:</b> FONTAINE <b>FOR:</b></p>  <div style="display: flex; justify-content: space-around; margin-top: 20px;"> <div style="text-align: center;">  FON-2E         </div> <div style="text-align: center;">  FON-4E         </div> </div> <div style="display: flex; justify-content: space-around; margin-top: 10px;"> <div style="text-align: center;">  FON-3E         </div> <div style="text-align: center;">  FON-5E         </div> </div> <p style="text-align: center; margin-top: 5px;">PROGRES</p>	<p><b>FOR:</b> FORT</p> <div style="display: flex; justify-content: space-around;">   </div> <div style="display: flex; justify-content: space-around; margin-top: 20px;"> <div style="text-align: center;">  FR-1D         </div> </div> <div style="display: flex; justify-content: space-around; margin-top: 10px;"> <div style="text-align: center;">  FR-2         </div> <div style="text-align: center;">  FR-4         </div> </div> <p style="text-align: center; margin-top: 5px;">DAD</p>
--	--

<p><b>PARA:</b> FORT <b>FOR:</b></p> <div style="display: flex; justify-content: space-around;">    </div> <div style="display: flex; justify-content: space-around; margin-top: 20px;"> <div style="text-align: center;"> <p>... 601-700  ... FR-7D</p> </div> <div style="text-align: center;"> <p>501-600  FR-8</p> </div> <div style="text-align: center;"> <p> FR-9D</p> </div> <div style="text-align: center;"> <p> FR-11D</p> </div> </div>	<p><b>FOR:</b> FORTE</p>  <div style="display: flex; justify-content: space-around; margin-top: 20px;"> <div style="text-align: center;">  FTE-1         </div> <div style="text-align: center;">  FTE-1D         </div> </div>
--	---

<p><b>PARA:</b> FORTIS <b>FOR:</b></p>  <div style="text-align: center; margin-top: 20px;">  FORTIS-2I     </div>	<p><b>FOR:</b> FTH</p> <div style="display: flex; justify-content: space-around;">    </div> <div style="display: flex; justify-content: space-around; margin-top: 20px;"> <div style="text-align: center;">  FTH-1         </div> <div style="text-align: center;">  FTH-1D         </div> </div> <div style="display: flex; justify-content: space-around; margin-top: 10px;"> <div style="text-align: center;">  FTH-8         </div> <div style="text-align: center;">  FTH-8D         </div> </div> <div style="display: flex; justify-content: space-around; margin-top: 10px;"> <div style="text-align: center;">  FTH-2         </div> <div style="text-align: center;">  FTH-3         </div> </div>
---	---

Copyright by  
Alejandro Altuna S.A.  
2005

**JMA**

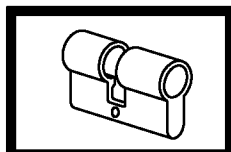

PARA:  
FOR:

FTH

PARA-FOR:

FTH (F)

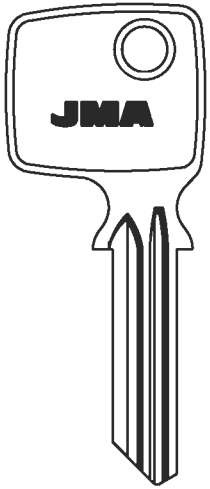

FTH-4



.....A 1 AL 9  
FTH-5

FTH-22

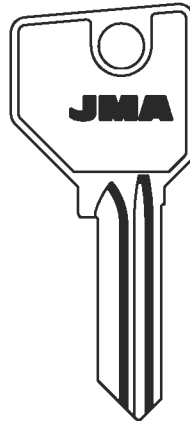

FTH-6

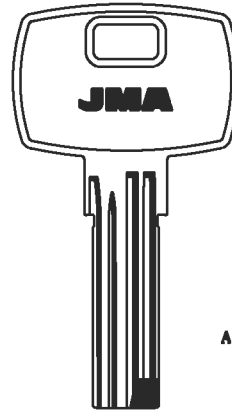

ALP.

8.6  
2.85  
FTH-7

CODEM-TOVER-YALTRES

PARA:  
FOR:

FTH

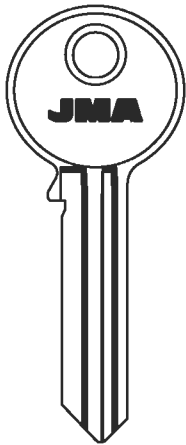

.....A 1 AL 9  
FTH-9

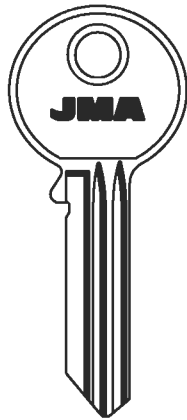

FTH-10

FTH-21  
CF-CIB-IFAM-JL-NICO-PROBAT  
CIBC-CITY-SUF



BKS  
BIRD  
CARAT  
LAREDO  
ROC  
WOC  
YALE

....0 AL 9  
FTH-11D



FTH-12D

PARA:  
FOR:

FTH

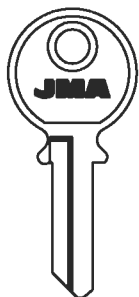

FTH-13D

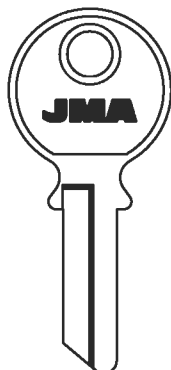

FTH-14D

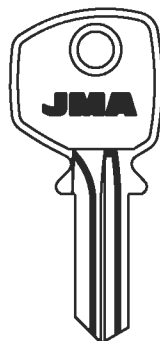

FTH-15

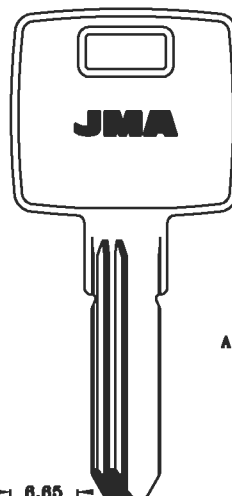

ALP.

8.85  
2.95  
FTH-16

IFAM-KARO

Copyright by  
Alejandro Altuna S.A.  
2005

JMA

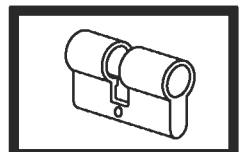

49

**PARA-FOR:**

PARA:  
FOR:

FTH

FTH (F)

GABON (F)

GATO (COL)

GBZ (I)

GE GE (A)

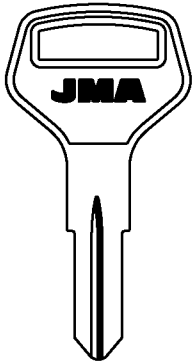

FTH-17D

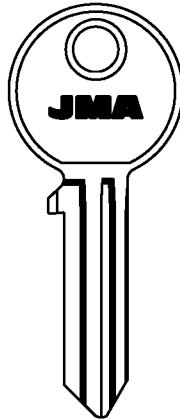

.....A 1 AL 9  
 FTH-18

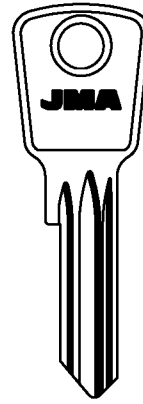

FTH-19  
FEDERAL

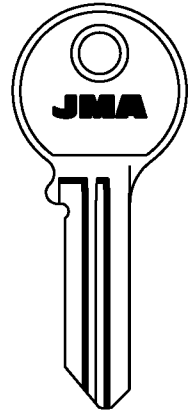

FTH-20D  
HERACLES

PARA:  
FOR:

GABON

GATO

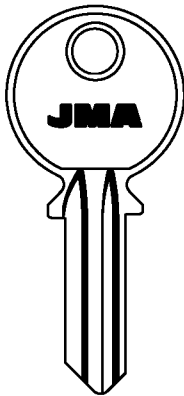

GAB-1I GAB-1D

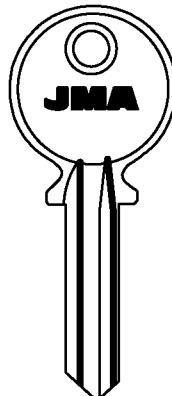

GAB-2

CHG-GALLUS-MAXIGARD-PICARDIE-SOS-WINNER



GAT-1

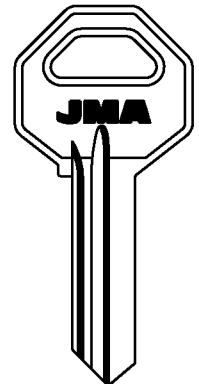

GAT-2D

LAT.

PARA:  
FOR:

GATO

GBZ

GE GE

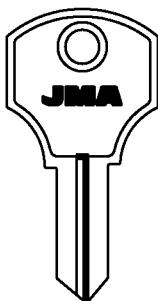

GAT-3D

LAT.

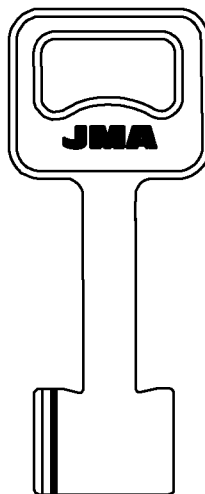

GBZ-1

LAT.



ABUS  
FLIK  
FULLEX  
GLOSTAL  
GRUNDMANN  
HOHRMANN  
PEROHAUS  
TZAFRER  
 GE-1D

GE-2

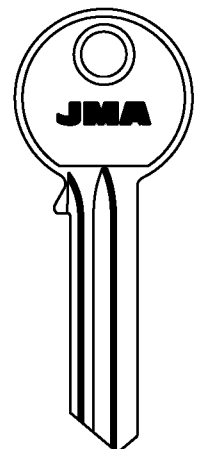

1.....  
500001-735807  
 GE-3D

ALFA

Copyright by  
Alejandro Altuna S.A.  
2005

**JMA**

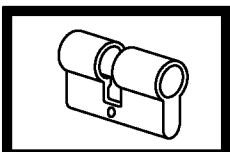

**50**

PARA:  
FOR:

GE GE

PARA-FOR:

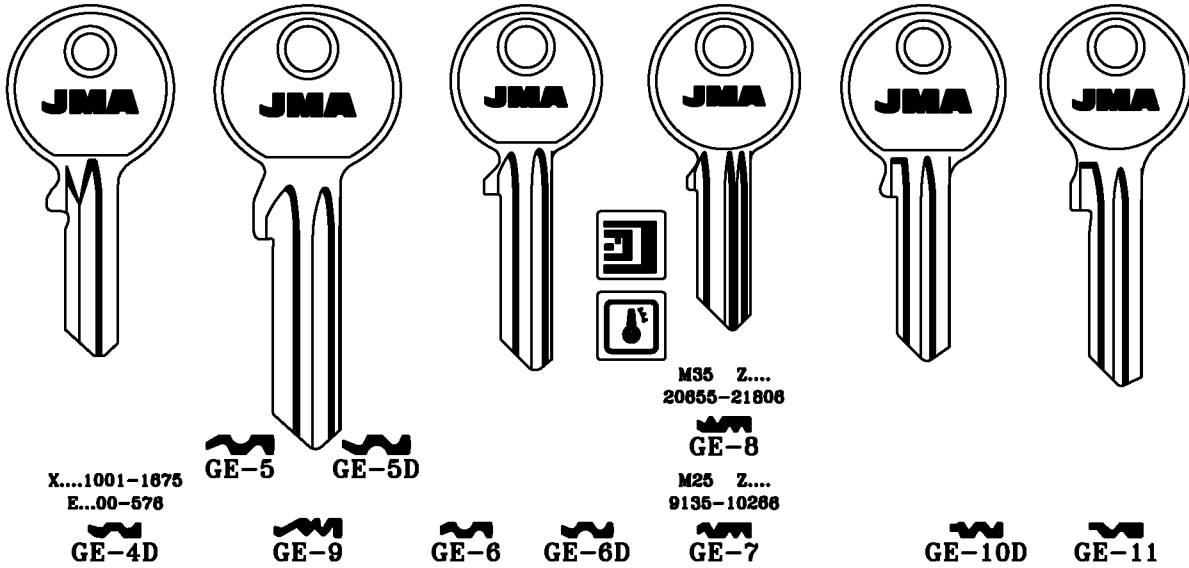

LABOFA-PEROHAUS

PEROHAUS

GE GE (A)

GEBA (D)

GERA (D)

GIBBONS (GB)

GIUSSANI (I)

PARA:  
FOR: GEB A

GERA

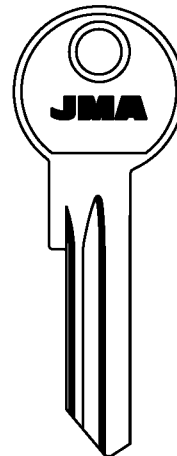
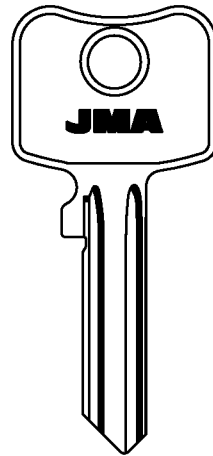
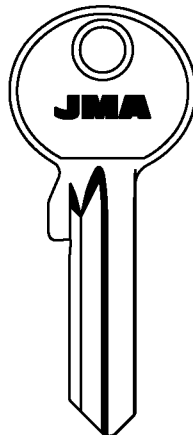
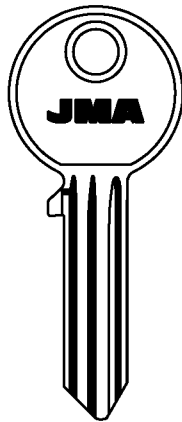
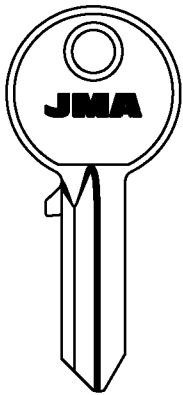

PARA:  
FOR: GIBBONS

GIUSSANI

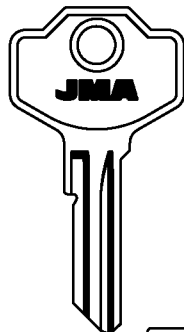
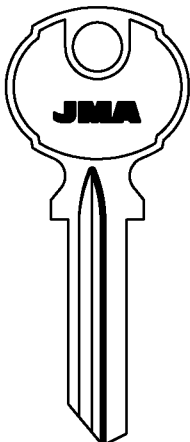

9001-9741  
3001-3480

GIU-1

GIU-1D

3001-3480

GIU-2

GIU-2D

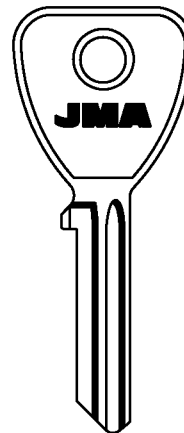
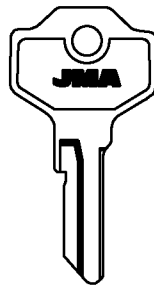

WILLENHALL

SIMECA

OAL-LUME

Copyright by  
Alejandro Altuna S.A.  
2005

JMA

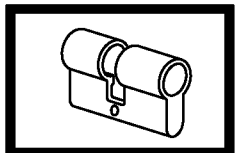

51

**PARA-FOR:**

**PARA: GLAZIEV**

**GLAZIEV (RUS)**

**GLOBE (RC)**

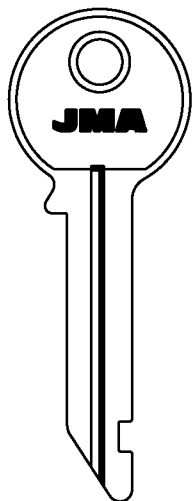

**GLA-1D**

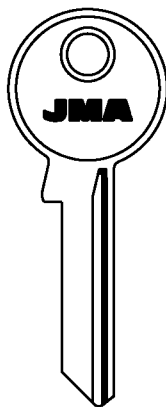

**GLO-1I GLO-1D**

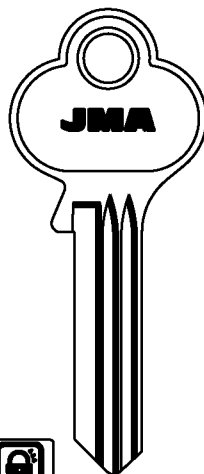

**GLO-2 GLO-2D**

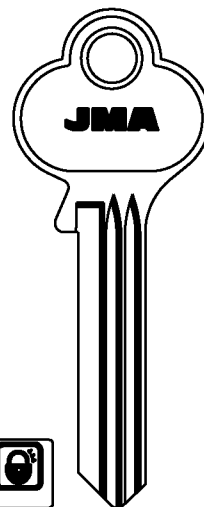

**GLO-3 GLO-3D**

**LARK**

**PARA: FOR:**

**GLOBE**

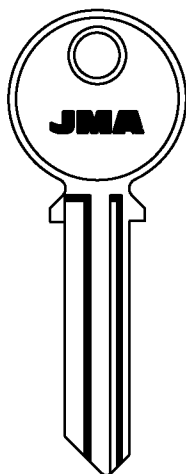

**GLO-4I GLO-4D**

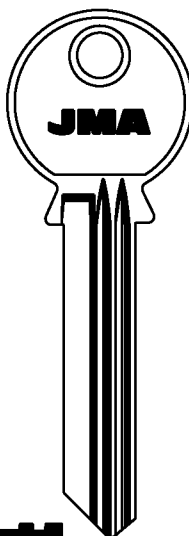

**GLO-5I**

**MIAN-FORCE**

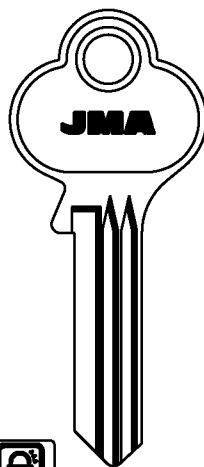

**GLO-6 GLO-6D**

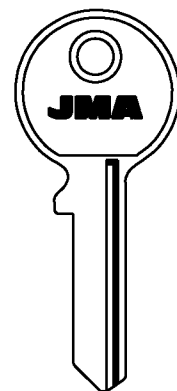

**GLO-7 GLO-7D**

**PARA: FOR:**

**GLOBE**



**GLO-8 GLO-8D**

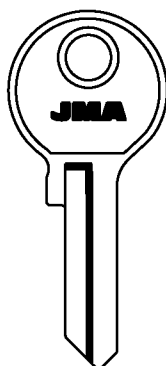

**GLO-9D**

**GOLD DOOR**

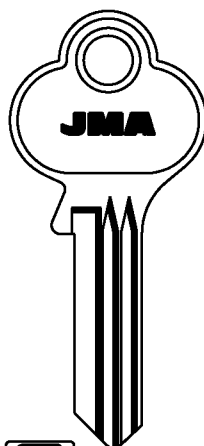

**GLO-10**



**GLO-11**





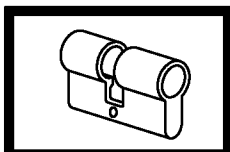



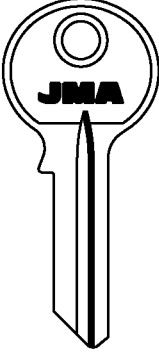
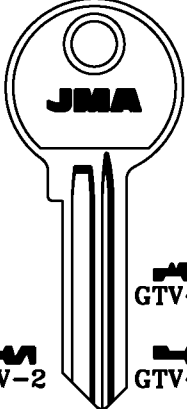

Copyright by  
Alejandro Altuna S.A.  
2005



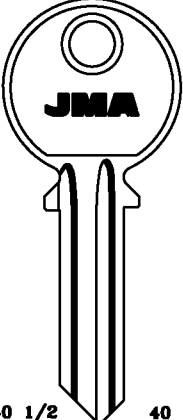



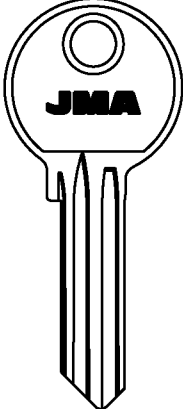

**JMA**

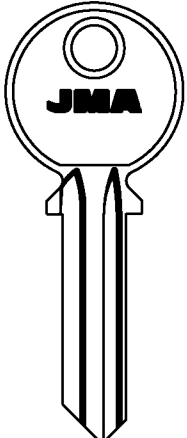
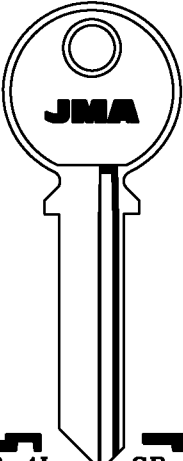
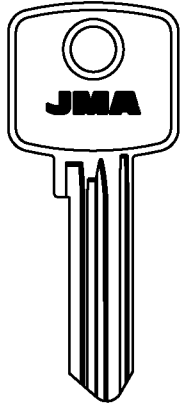



**52**

ATENCION:Concerniente a las marcas y denominaciones comerciales ver nota en indice.ATTENTION:Concerning the marks and commercial denominations see note in index.  
ATTENTION:Concernant les marques et denominations commerciales voir la note dans l'index.ACHTUNG:Beziehen auf die marke und handelsname sehen sie die notiz im index.

<b>PARA: FOR:</b> GLOBE	<b>GTV</b>	<b>GUARD</b>		<b>PARA-FOR:</b>
 <b>GLO-12D</b>	 <b>GTV-1D</b>  <b>GTV-2</b>  <b>GTV-2D</b>  <b>GTV-3D</b>  <b>GTV-4D</b> <b>TIEFENTHAL</b>	 <b>GUA-1</b>  <b>GUA-1D</b>  <b>GUA-2</b>  <b>GUA-2D</b>	 <b>GUA-3</b>  <b>GUA-3D</b>	<b>GLOBE (RC)</b> <b>GTV (D)</b> <b>GUARD (HK)</b> <b>GUERVILLE R. (F)</b> <b>HÄFELE (D)</b>

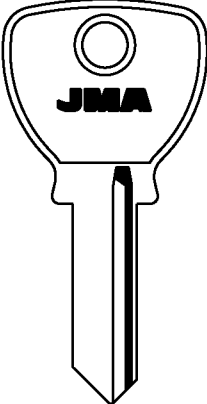
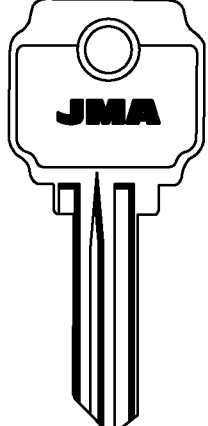
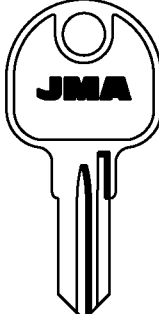
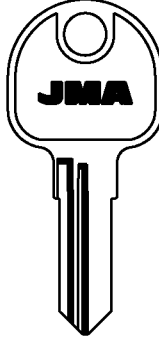
<b>PARA: FOR:</b>	<b>GUERVILLE RI.</b>			
 <b>GR-1I</b> <b>ALU.</b> <b>DEBEAURAIN FT MONDIAL SE WINNER</b>	 <b>GR-1D</b>	 <b>GR-4I</b>	 <b>GR-4D</b>	
 <b>GR-2I</b>	 <b>GR-2D</b>	 <b>GR-3I</b>	 <b>GR-3D</b>	 <b>GR-5I</b>
		 <b>GR-5D</b>	 <b>GR-6</b>	 <b>GR-6D</b>
		<b>PERRIER</b>		

<b>PARA: FOR:</b>	<b>GUERVILLE R.</b>	<b>HÄFELE</b>	
 <b>GR-7</b>	 <b>GR-7D</b> <b>MONDIAL</b>	 <b>HAF-1</b>	 <b>HAF-1D</b> <b>LAT.</b>
		 <b>HAF-4</b>	 <b>HAF-2D</b>

Copyright by  
Alejandro Altuna S.A.  
2005

**JMA**

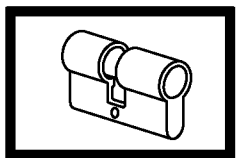

**53**

**PARA-FOR:**

**HÄFELE (D)**

**HAGA (RC)**

**HARKOV (RUS)**

**HARLOC (USA)**











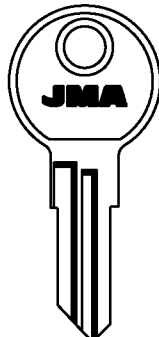

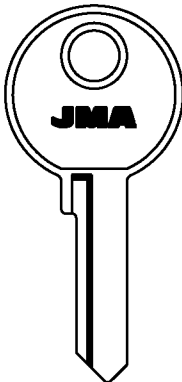

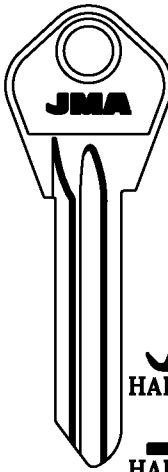



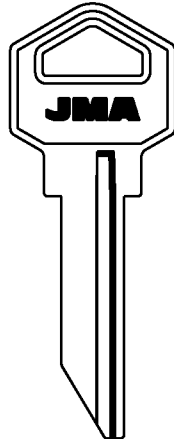

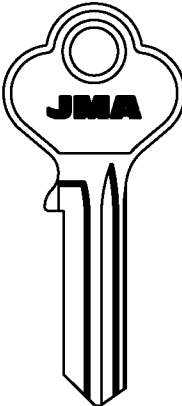

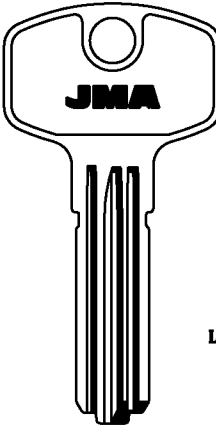
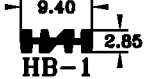
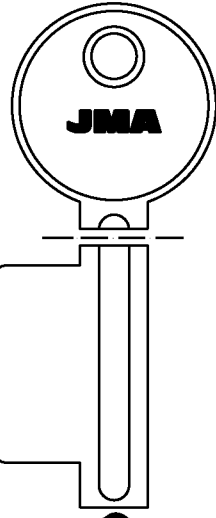

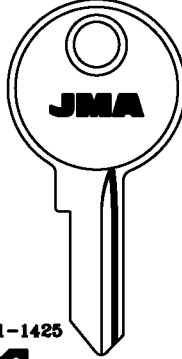
**HB (I)**

**HECTOR (E)**

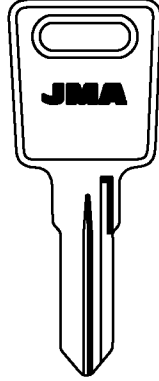
**HEKNA (D)**

**HENDERSON (USA)**

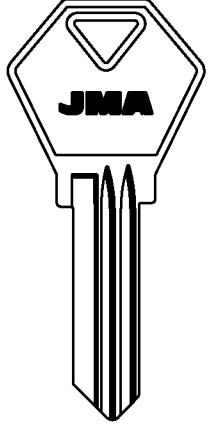
**HORSE (RC)**







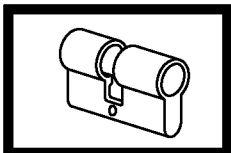

<p>PARA: HÄFELE FOR:</p>  <p><b>JMA</b></p>  <p>HAF-3D</p>	<p>HAGA</p>  <p><b>JMA</b></p>  <p>HAG-1D</p>	<p>HARKOV</p>  <p><b>JMA</b></p>  <p>HAK-1D</p>  <p>HAK-2D</p>  <p>HAK-5</p>  <p>HAK-3</p>	
<p>PARA: HARKOV FOR:</p>  <p><b>JMA</b></p>  <p>HAK-4</p>	<p>HARLOC</p>  <p><b>JMA</b></p>  <p>HAR-1I</p> <p>DNS-EAGLE-LORI</p>	<p>HB</p>  <p><b>JMA</b></p>  <p>HB-1</p> <p>9.40 2.85</p>	<p>HECTOR</p>  <p><b>JMA</b></p> <p>LAT. 90 mm.</p>  <p>HEC-1</p>
<p>PARA: HEKNA FOR:</p>  <p><b>JMA</b></p> <p>....1001-1425</p>  <p>HEK-1</p>  <p>HEK-2</p>  <p>HEK-3</p>  <p><b>JMA</b></p>  <p>HEK-4</p> <p>METALCASTELLI-RAUCO-REGENT</p>		<p>HENDERSON</p>  <p><b>JMA</b></p> <p>R 008-254</p>  <p>HEN-1</p>  <p>HEN-1D</p> <p>REGENT</p>	<p>HORSE</p>  <p><b>JMA</b></p>  <p>HOR-1</p>

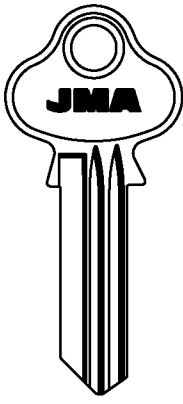
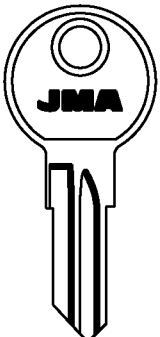
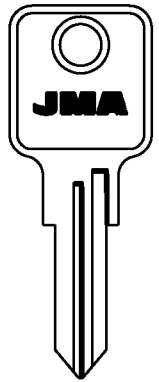
Copyright by  
Alejandro Altuna S.A.  
2005







**JMA**



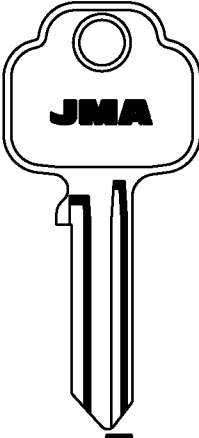
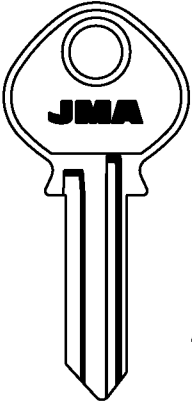
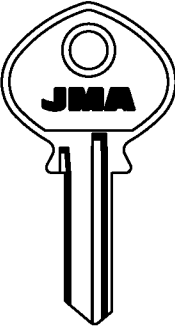
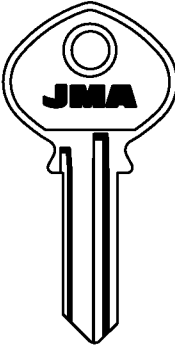



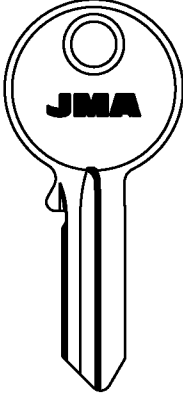
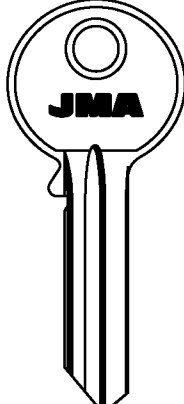

**54**

<b>PARA: FOR:</b> HORSE	HUDSON	HUWIL		<b>PARA-FOR:</b> <b>HORSE (RC)</b> <b>HUDSON (USA)</b> <b>HUWIL (D)</b> <b>IBEAR (E)</b> <b>ICA (E)</b> <b>ICSA (I)</b> <b>IFAM (E)</b>
				
 HOR-2  HOR-2D	 HUD-2D	W 3000-4000 A 3001-4000  HUW-1  HUW-1D	N 0005-1878 N 2001-2204  HUW-N	

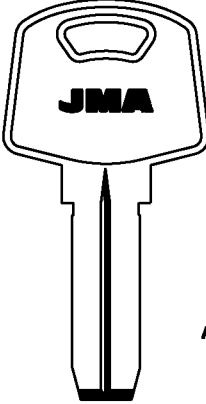
STRAFOR-STEELCASE

<b>PARA: FOR:</b> IBEAR	ICA		
			
 IB-1   IB-2  ICA-SERRALLER	ALU.   ICA-1	 ICA-4IP	 ICA-5IP

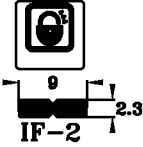
<b>PARA: FOR:</b> ICSA	IFAM		
			
 ICS-1D  ZANI	 ICS-2D	LAT. ALU.  IF-11  JOMA	ALP.  IF-2

Copyright by  
Alejandro Altuna S.A.  
2005

**JMA**

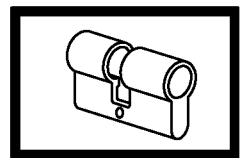

ATENCION:Concerniente a las marcas y denominaciones comerciales ver nota en indice.ATTENTION:Concerning the marks and commercial denominations see note in Index.  
ATTENTION:Concernant les marques et denominations commerciales voir la note dans l'index.ACHTUNG:Beziehen auf die marke und handelsname sehen sie die notiz im Index.

**PARA-FOR:**

**IFAM (E)**

**IGS (F)**

**IKON (D)**

**PARA:** IFAM  
**FOR:**

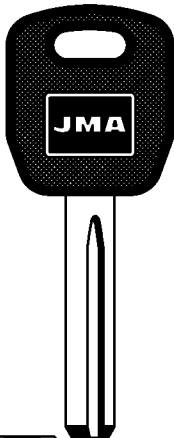

ALP.



IF-15  
TEM

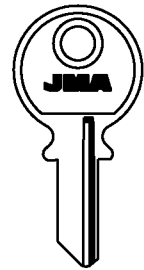

IF-120

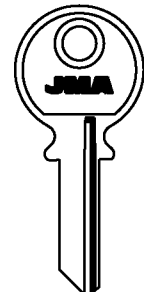

IF-D20



IF-125



IF-D25

BATU-FADE-JOMA  
GUARD-RIPA-TEM

**PARA:** IFAM  
**FOR:**

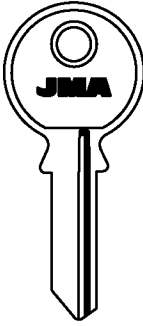

IF-130  
JOMA



IF-D30



IF-140  
RIPA



IF-35



IF-140L  
RIPA



IF-150



IF-45/55

• ALU.  
• LAT.  
• FSH.

**PARA:** IFAM  
**FOR:**

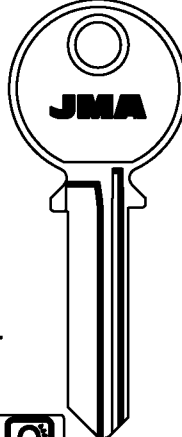

LAT.

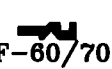

IF-60/70

IF-160/70

**PARA:** IGS  
**FOR:**

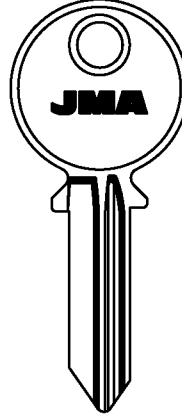

IGS-1

**PARA:** IKON  
**FOR:**

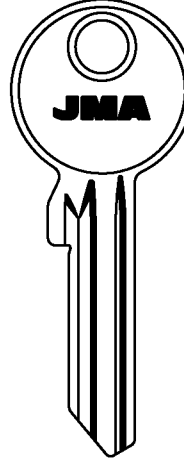

SN4  
ZE-1



SN2  
ZE-2



N2  
ZE-6



SN3  
ZE-1D



SN1  
ZE-2D



N1  
ZE-6D



M  
ZE-9D

BRUMME-OTIS

Copyright by  
Alejandro Altuna S.A.  
2005

**JMA**

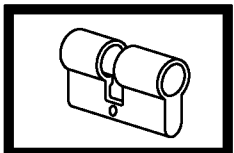

**56**

PARA:  
FOR:

# IKON

PARA-FOR:

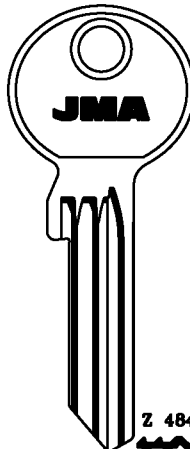
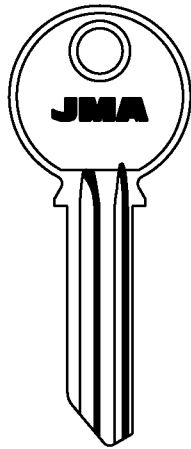
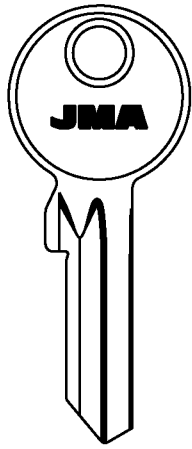
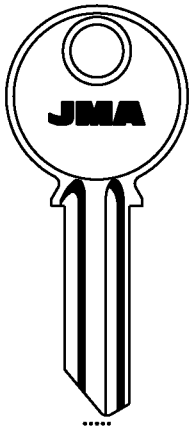

.....  
1 AL 9 AL 0  
A-B-C-D-E-F-G-H-I-L

N2  
ZE-5I

N1  
ZE-5D

N1  
ZE-7D

ZE-8

Z 484  
ZE-10D

Z 481  
ZE-11D

BRUMME-OTIS

**IKON (D)**  
**ILARGI (E)**  
**ILCO (USA)**  
**ILLINOIS (USA)**

PARA:  
FOR:

# IKON

# ILARGI

# ILCO

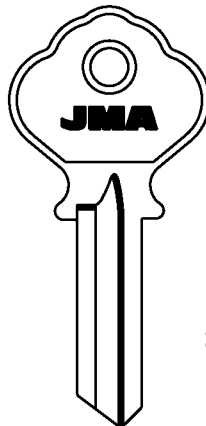
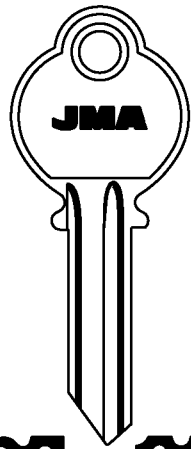
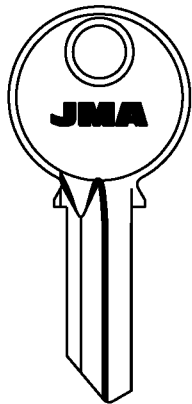

K2  
ZE-K2

K1  
ZE-K1

K6  
ZE-K6

K5  
ZE-K5

N1  
ZE-N1

ALU.

IL-1I

IL-1D

IL-2

LAT.

ILC-1D

CORONA-FORT-SCHRITT

BURG

PARA:  
FOR:

# ILCO

# ILLINOIS

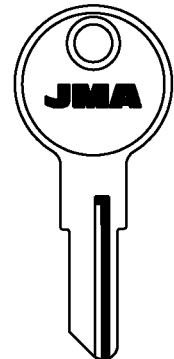
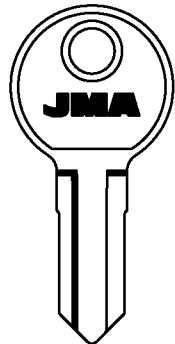
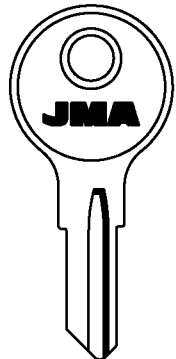
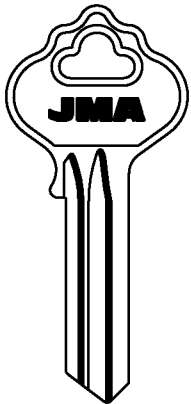

LAT.

LAT.

ILC-2D

ILC-3

ILL-1  
GRAYHILL-LAGRANGE-OTIS  
SEEBURG

ILL-2

ILL-2D



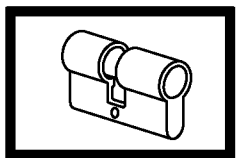



Copyright by  
Alejandro Altuna S.A.  
2005



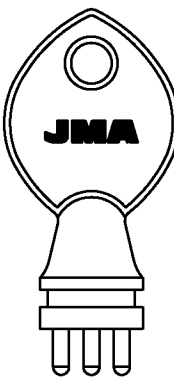
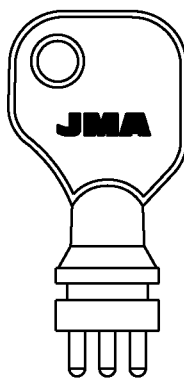
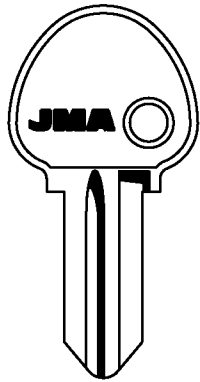







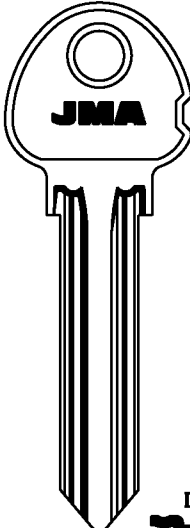
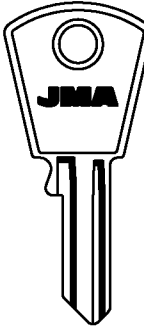
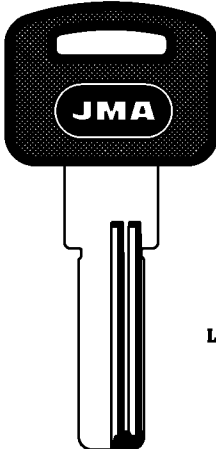









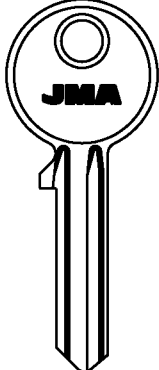
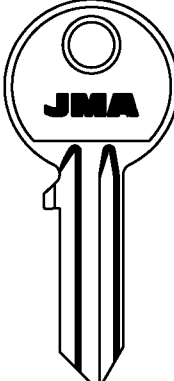
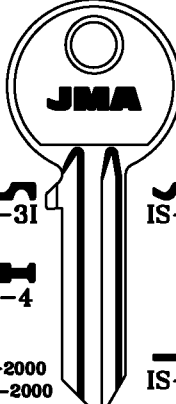
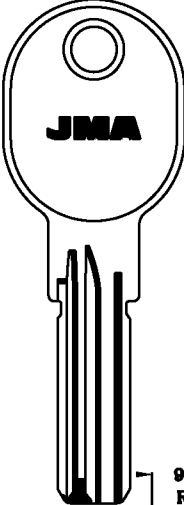

ATENCIÓN:Concerniente a las marcas y denominaciones comerciales ver nota en índice.ATTENTION:Concerning the marks and commercial denominations see note in index.  
ATTENTION:Concernant les marques et dénominations commerciales voir la note dans l'index.ACHTUNG:Beziehen auf die marke und handelsname sehen sie die notiz im index.

**PARA-FOR:**

- IMB (KW)**
- INCECA (E)**
- INGERSOLL (USA)**
- INT (D)**
- IR (F)**
- ISEO (I)**

<b>PARA: FOR:</b>	<b>IMB</b>	<b>INCECA</b>		<b>INGERSOLL</b>
				
	 	 INCE-1E	 INCE-2E	 ING-6

<b>PARA: FOR:</b>	<b>INGERSOLL</b>		<b>INT</b>	<b>IR</b>
				
	 ING-A	 ING-N	 ING-S	 ING-W
		 ING-D	 INT-1	 INT-1D
				 IR-1.P

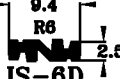
<b>PARA: FOR:</b>	<b>ISEO</b>			
				
	 IS-1I	 IS-1D	 IS-2I	 IS-2D
			 IS-3I	 IS-3D
			 IS-4	
			 IS-5D	
			 IS-7D	
			 IS-8	 IS-8D
				 IS-6D





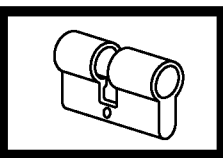



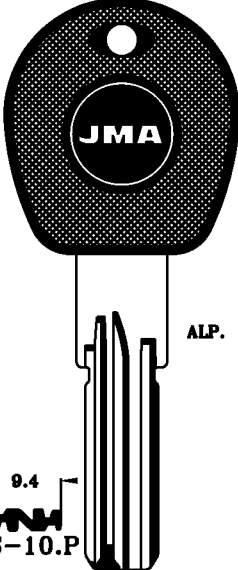
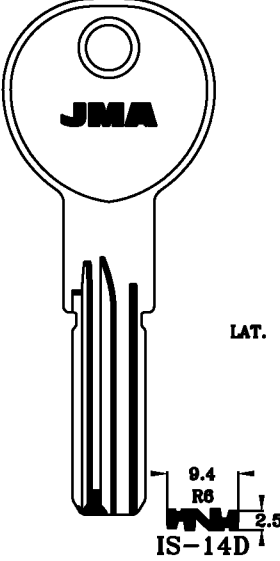
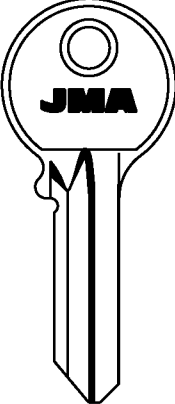
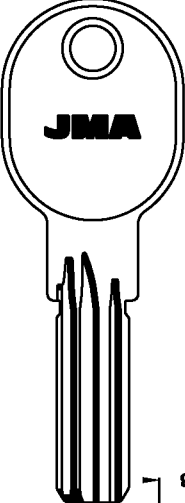
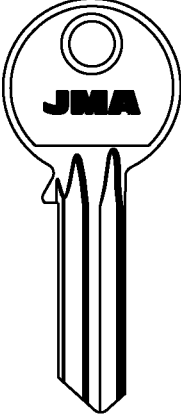
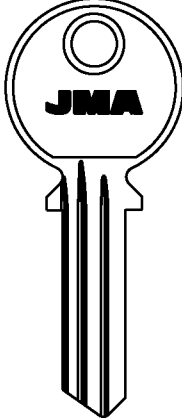
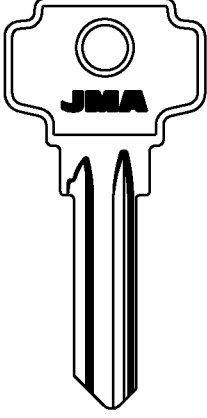

Copyright by  
Alejandro Altuna S.A.  
2005

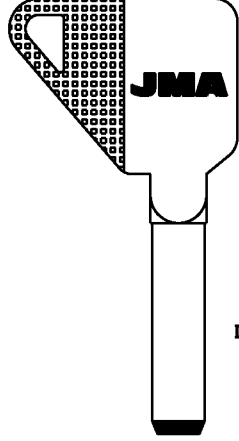
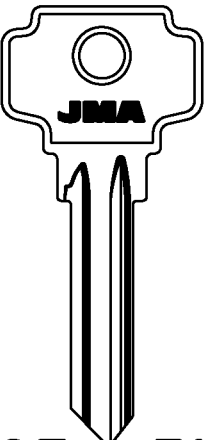
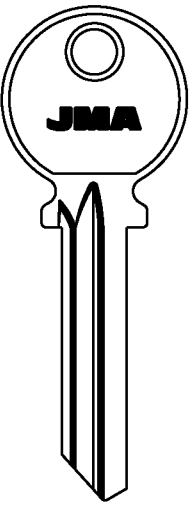
**JMA**





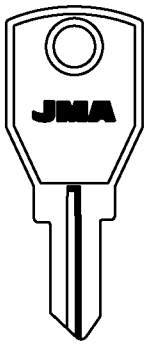

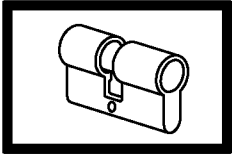





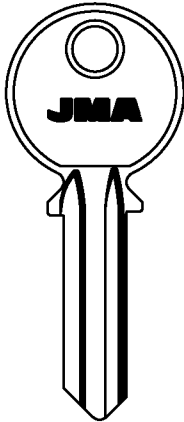
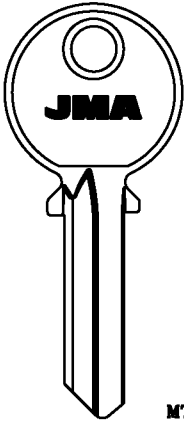

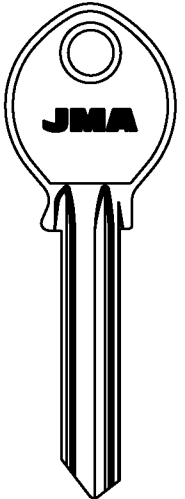
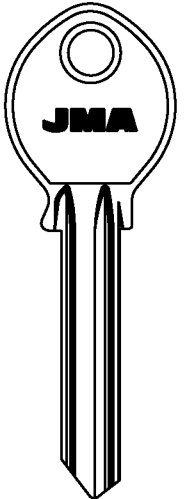



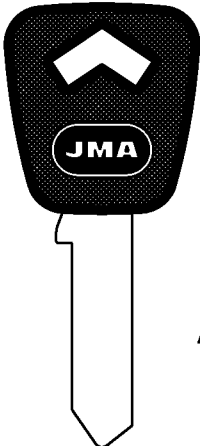
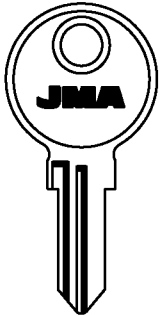
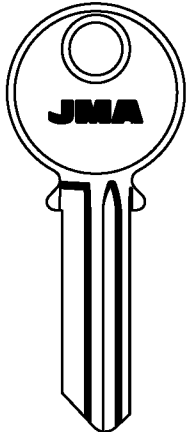
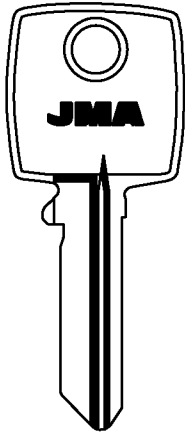

**58**

ATENCION:Concerniente a las marcas y denominaciones comerciales ver nota en indice.ATTENTION:Concerning the marks and commercial denominations see note in index. ATTENTION:Concernant les marques et denominations commerciales voir la note dans l'index.ACHTUNG:Beziehen auf die marke und handelsname sehen sie die notiz im index.

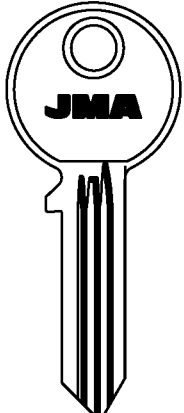
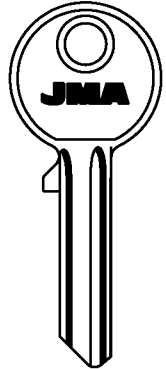
<p><b>PARA:</b> ISEO <b>FOR:</b></p>  <p>ALP.</p>  <p>LAT.</p>	<p><b>ITO</b></p>  <p>ITO-1D</p>  <p>LAT.</p> <p>ITO-2D</p>	<p><b>PARA-FOR:</b></p> <p>ISEO (I) ITO (TR) IVANA (D) JARDI (E) JINLONG (RC)</p>
<p><b>PARA:</b> IVANA <b>FOR:</b></p>  <p>IV-1</p>  <p>IV-2D</p>	<p><b>JARDI</b></p>  <p>JAR-1I</p>  <p>JAR-1D</p>  <p>JAR-3</p>  <p>LAT.</p> <p>JAR-1E</p>	
<p><b>PARA:</b> JARDI <b>FOR:</b></p>  <p>JAR-2I</p>  <p>JAR-2D</p>  <p>JAR-6</p>  <p>JAR-6D</p>  <p>JAR-4D</p>  <p>JAR-5I</p>  <p>JAR-5D</p>	<p><b>JINLONG</b></p>  <p>JIN-1D</p>	<p>Copyright by Alejandro Altuna S.A. 2005</p>   <p><b>59</b></p>

**PARA-FOR:**

- JIP (E)**
- JIS (E)**
- JOMA (E)**
- JOVI (E)**
- JOWIL (D)**

<b>PARA: FOR:</b>	<b>JIP</b>	<b>JIS</b>			
					
	 			<b>SEMEL</b>	
		ALU. LAT. COL. FSH. MTIC.(J)		LAT. ALU.	
<b>PARA: FOR:</b>	<b>JIS</b>	<b>JOMA</b>	<b>JOVI</b>	<b>JOWIL</b>	
					
					
	ALP.				
<b>PARA: FOR:</b>	<b>JOWIL</b>				
					
					
		ESZ FHÜR GTV JÜNGST MERCUR OSKO PANTHER TIEFENTHAL TRITON VOKO WEPA			

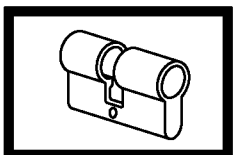

Copyright by  
Alejandro Altuna S.A.  
2005

**JMA**





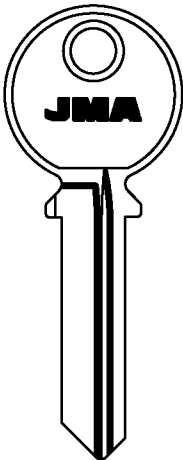



**60**

**PARA:** JOWIL  
**FOR:**

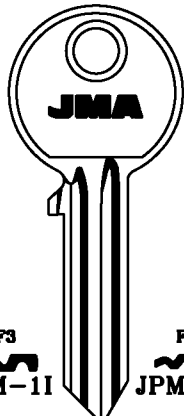

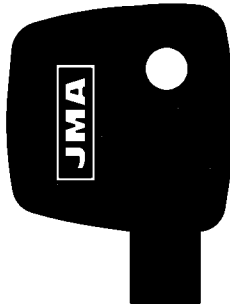

**JWL-7D**

**JPM**

**JPM-1E**

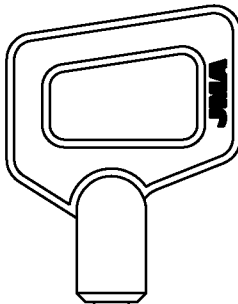

**JPM-2E**

**ABUS**

**PARA-FOR:**

**JOWIL (D)**



**JPM (F)**

**JTF (F)**

**JU JUNGINGER (D)**



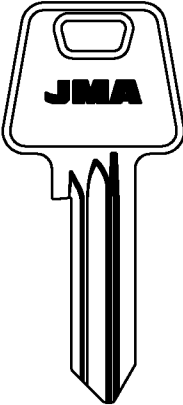



**JUNIE (D)**

**PARA:** JPM  
**FOR:**

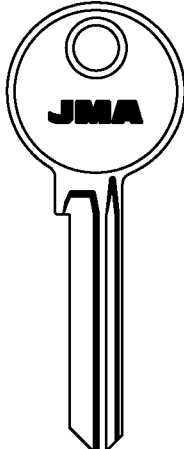

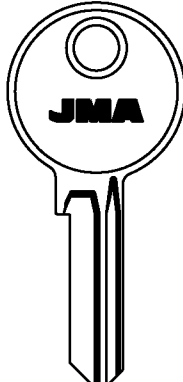

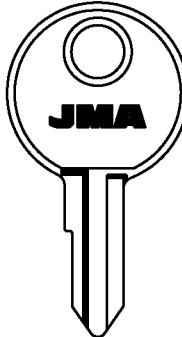



**JPM-3D**

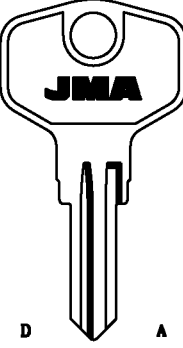









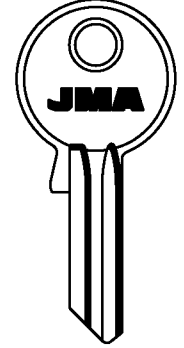

**JTF**

**PARA:** JU JUNGIN.  
**FOR:**

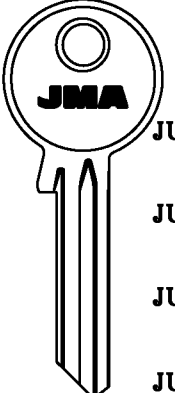





**JUNIE**

**PEROHAUS-US**

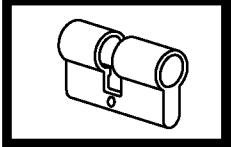
Copyright by  
Alejandro Altuna S.A.  
2005

**61**

**PARA-FOR:**

**JUNKUNC  
(USA)**

**JUZU (E)**

**JVAL (P)**

**KABA (CH)**

PARA: FOR:	JUNKUNC	JUZU	JVAL
	<p>LAT.</p> <p>1 AL 8 JU-1</p> <p>LION-AMERICAN</p>	<p>1 AL 8 JU-2</p> <p>ALSO-BULT</p>	<p>JV-11</p> <p>JV-2</p> <p>JV-7</p> <p>JV-1D</p> <p>JV-7D</p> <p>P.C.-FEB</p>

PARA: FOR:	JVAL	KABA		
	<p>JV-3I</p> <p>JV-3D</p> <p>JV-4I</p> <p>JV-5I</p> <p>JV-6</p> <p>P.C.-FEB</p>	<p>S15-S16 S17-S18 S53-S58 S59-S61</p> <p>ALP.</p> <p>7.85 8</p> <p>1.95</p> <p>KA-1</p> <p>7.85 8</p> <p>1.95</p> <p>KA-7</p> <p>LASBOLAGET</p>	<p>ALP.</p> <p>7.9 20</p> <p>2.45</p> <p>KA-2</p> <p>6.75</p> <p>2.45</p> <p>KA-3</p> <p>KA-4</p> <p>GEMINI</p>	<p>ALP.</p> <p>MICRO KABA</p> <p>4.3</p> <p>1.45</p> <p>KA-5</p>

PARA: FOR:	KABA			
	<p>ALP.</p> <p>7.85</p> <p>1.95</p> <p>KA-6</p>	<p>ALP.</p> <p>7.88</p> <p>2.46</p> <p>KA-8</p>	<p>ALP.</p> <p>6.79</p> <p>2</p> <p>KA-10</p>	<p>ALP.</p> <p>6.7</p> <p>2</p> <p>KA-11</p>

Copyright by  
Alejandro Altuna S.A.  
2005

**JMA**

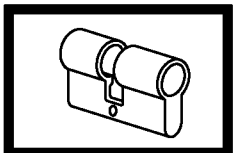

**62**

PARA:  
FOR:

### KALE

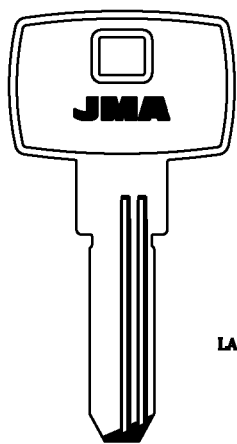

LAT.

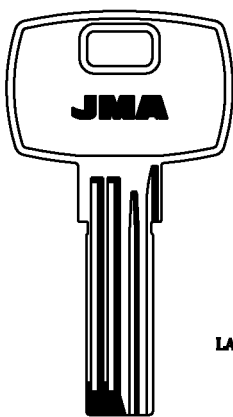
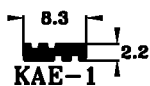

LAT.

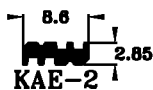

KAE-3

KAE-3D

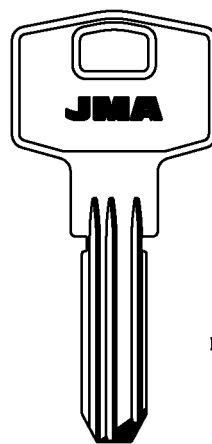

LAT.



**PARA-FOR:**

**KALE (TR)**

**KALUGA (RUS)**

**KAP (RUS)**

**KAZAN (RUS)**

PARA:  
FOR:

### KALE

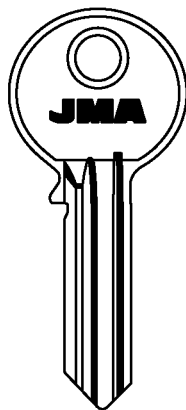

KAE-5

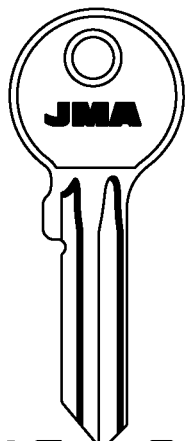

KAE-6

KAE-6D

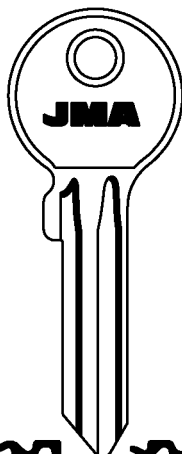

KAE-8

KAE-8D

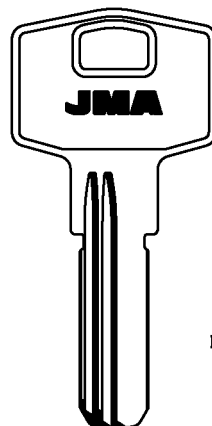

LAT.



JIS

PARA:  
FOR: KALUGA

### KAP

### KAZAN

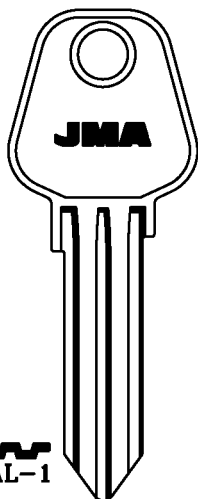

KAL-1

KAL-2D

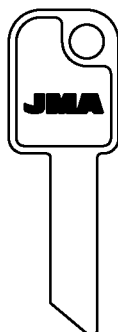

LAT.

X  
KAP-1D

C  
KAP-2D



KAZ-1

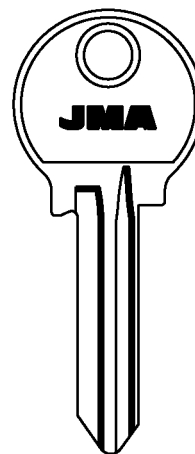

KN  
KAZ-2

Copyright by  
Alejandro Altuna S.A.  
2005

# JMA

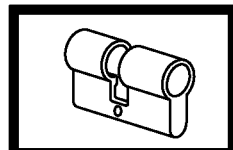

**PARA-FOR:**

PARA:  
FOR:

**KAZAN**

**KAZAN (RUS)**

**KESO (CH)**

**KFV (D)**

**KICHINEV  
(RUS)**

**KIFERM (F)**

**KIROVSMACH  
(RUS)**

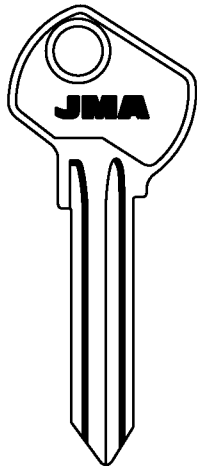

KAZ-3

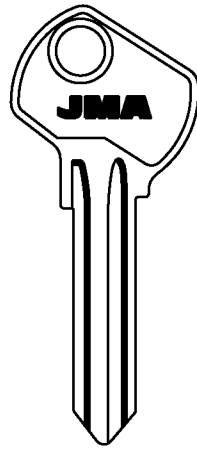

KAZ-4

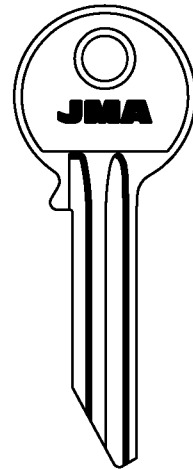

KAZ-5

KAZ-5D

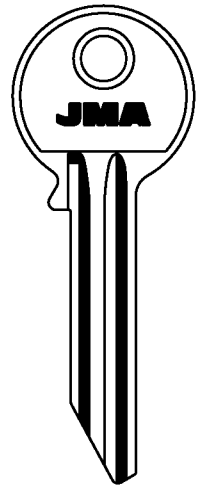

KAZ-6

PARA: KAZAN  
FOR:

**KESO**

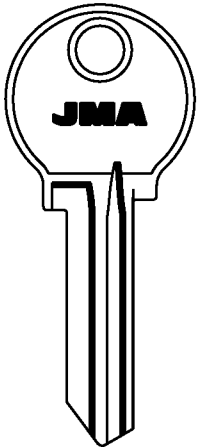

KAZ-7

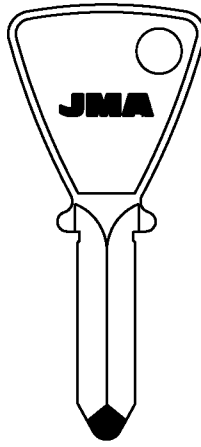

7.49  
2.7  
KE-1

JPM

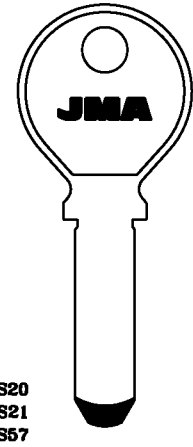

S20  
S21  
S57

7.6  
2000  
2.45  
KE-3

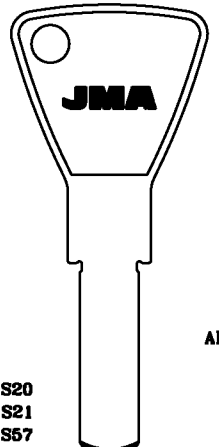

S20  
S21  
S57

7.6  
2000  
2.45  
KE-4

PARA: KFV  
FOR:

**KICHINEV**

**KIFERM**

**KIROVSMACH**



COMBA  
FCV  
FLIETHER  
GIESCHE  
GOTZ  
GRAF  
HSA  
NICO  
SEN  
SCHUCO

ALU.

KFV-1

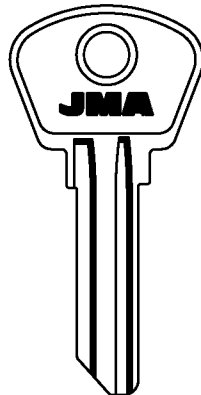

KIC-1

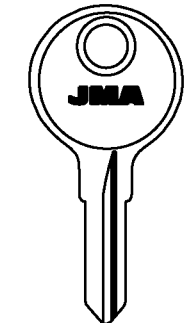

KIF-1

KIF-1D

KIF-2D

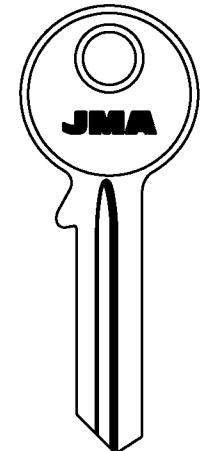







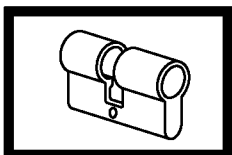



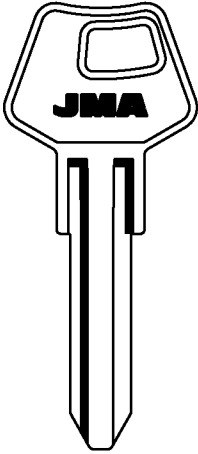

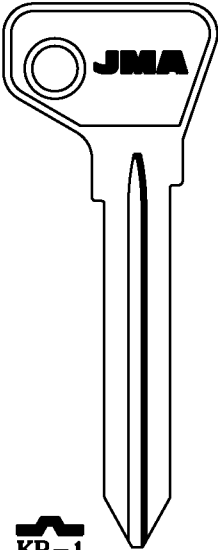

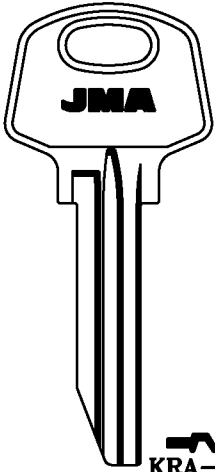

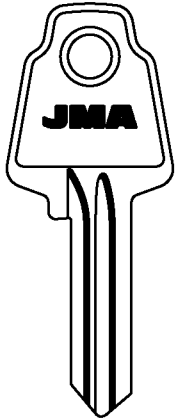

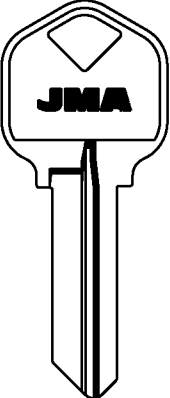

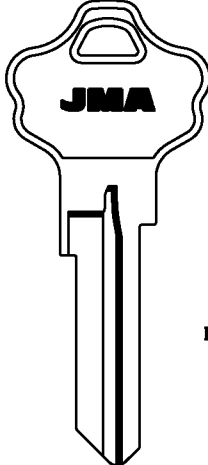

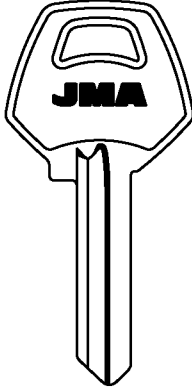

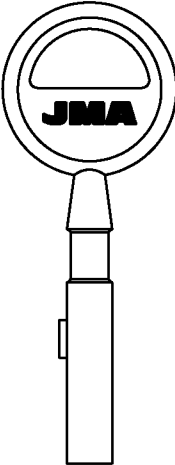

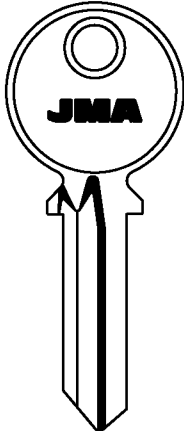
KIR-1D

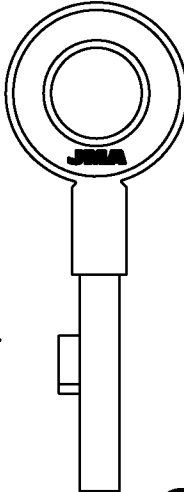
Copyright by  
Alejandro Altuna S.A.  
2005

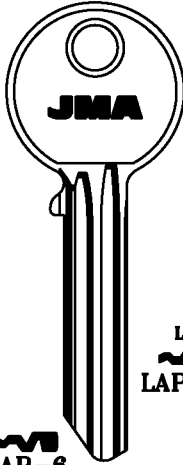
**JMA**



**64**

<b>PARA:</b> <b>FOR:</b> KIROVSMACH	<b>KP</b>	<b>KRAMATORSK</b>	<b>KREMENCHUG</b>	<b>PARA-FOR:</b> <b>KIROVSMACH (RUS)</b> <b>KP (RUS)</b> <b>KRAMATORSK (RUS)</b> <b>KREMENCHUG (RUS)</b> <b>KWIKSET (USA)</b> <b>LAFONTE (BR)</b> <b>LAPERCHE (F)</b>
  <b>KIR-2</b>	  <b>KP-1</b>	  <b>KRA-2</b>  <b>KRA-1D</b>	  <b>KRE-1D</b>	
<b>PARA:</b> <b>FOR:</b> KWIKSET	<b>LAFONTE</b>	<b>LAPERCHE</b>	<b>LAPERCHE (F)</b>	
 <b>1 AL 7</b>  <b>KWI-1</b> <b>BRICARD-EZSET-VACHETTE</b>	 <b>LAT.</b>  <b>KWI-2D</b> <b>TITAN</b>	  <b>LAF-1D</b>		
<b>PARA:</b> <b>FOR:</b> LAPERCHE				
 <b>LAT.</b>  <b>LAP-1E</b>	 <b>LAT.</b>  <b>LAP-2D</b>	 <b>LAT.</b>  <b>LAP-2E</b>	  <b>LAP-7D</b>  <b>LAP-6</b>  <b>LAP-3I</b>  <b>LAP</b>  <b>LAP-3D</b> <b>GEMM-RONIS</b>	

Copyright by  
Alejandro Altuna S.A.  
2005

**JMA**

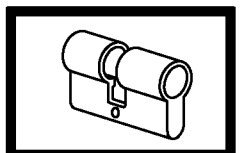

**65**

**PARA-FOR:**

**LAPERCHE (F)**

**LAPORTE (D)**

**PARA:**  
**FOR:**

**LAPERCHE**

ALP. ALP.

LAP-4 LAP-5D LAP-8D LAP-11D LAP-9 LAP-9D

GEMM-RONIS

**PARA:**  
**FOR:**

**LAPERCHE**

ALP. ALP.

LAP-10D LAP-13.P LAP-17.P LAP-20.P LAP-21.P LAP-22.P LAP-23.P LAP-28D LAP-29D LAP-30D LAP-34D

GEMM-RONIS

**PARA:**  
**FOR:**

**LAPERCHE**

S  
LAP-42D  
X  
LAP-43D  
T  
LAP-44D  
V  
LAP-45D  
R  
LAP-46D  
LAP-96D

GEMM-RONIS VACHETTE

**LAPORTE**

LPO-1 LPO-2

Copyright by  
Alejandro Altuna S.A.  
2005

**JMA**

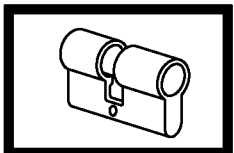

**66**

PARA:  
FOR:

LARK

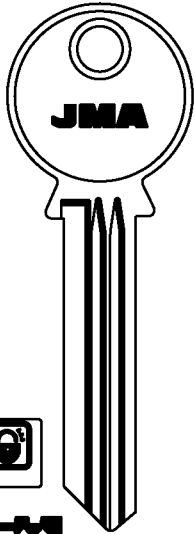

LAR-11

LAS

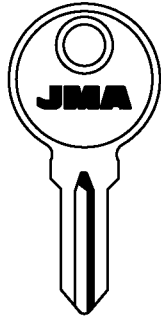

AX  
001-224  
LAS-AX

EX  
LAS-1D



ABBES  
ATAL  
DUBOIS  
ORDO  
RENZ  
STRAFOR

FM  
LAS-2

FM  
001-400  
501-550  
LAS-4



FH  
001-400  
501-550  
LAS-FH

LAS-4D

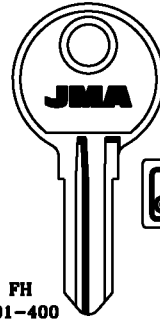

FH  
001-400  
501-550  
LAS-3

H  
LAS-5

U  
LAS-U



E  
LAS-5D

X  
LAS-X

ATAL-HAEFELE-KIFERM-RENZ

KIFERM

PARA-FOR:

LARK (RC)

LAS (F)

PARA:  
FOR:

LAS

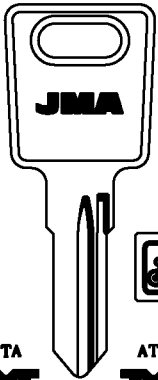

TA  
LAS-6

AT  
LAS-6D

RM  
0001-2000  
KT  
3001-4000

LAS-KT

TK  
4001-5000  
LAS-TK

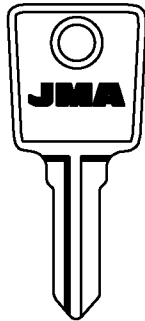

LAS-7

ABBES-ORDO

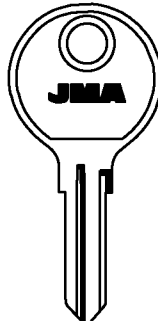

LS  
LAS-8

L  
LAS-9

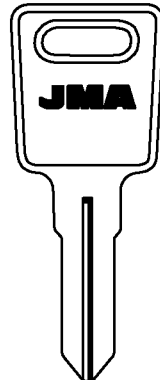

PR  
LAS-10

MARCADET

ATAL-KIFERM-MARCADET-RONIS

PARA:  
FOR:

LAS

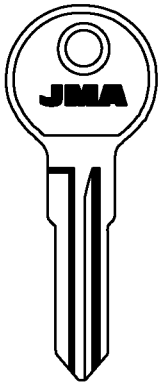

A...1-850  
LAS-11 LAS-11D



LAS-12D

ATAL-KIFERM-RENZ

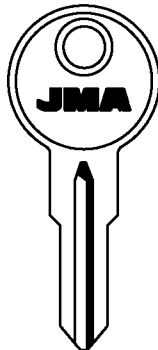

AX  
001-224  
LAS-AX/L

ATAL-HAEFELE-KIFERM-RENZ

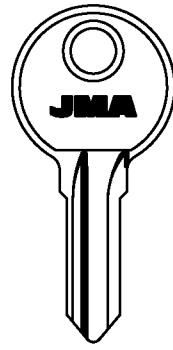

R  
001-224  
LAS-R

DUBOIS-KIFERM-PJ-PK

V  
001-224  
LAS-V

Y  
001-224  
LAS-Y

Copyright by  
Alejandro Altuna S.A.  
2005

JMA

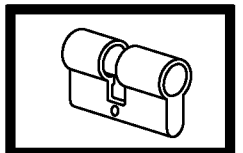



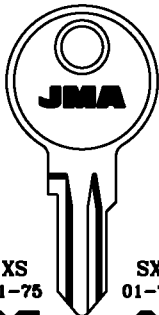
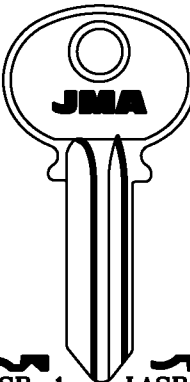
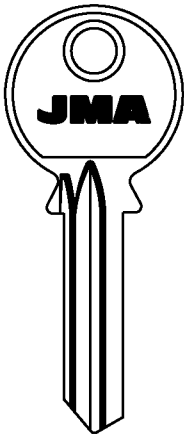
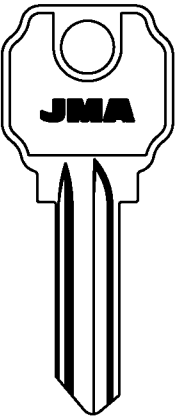

67

**PARA-FOR:**

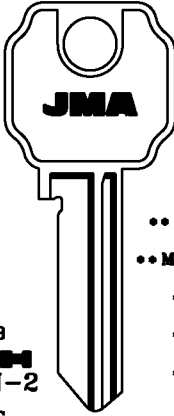
- LAS (F)**
- LÅSBOLAGET (S)**
- LEGG (GB)**
- LINCE (E)**

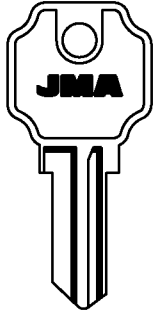
PARA: FOR:	LAS	LÅSBOLAGET	LEGG	LINCE
	 <p>XS 01-75 LAS-XS</p> <p>SX 01-75 LAS-SX</p> <p>TX 01-75 LAS-TX</p> <p>XY 01-75 LAS-XY</p>	 <p>LASB-1</p> <p>LASB-2</p> <p>LASB-3D</p>	 <p>1 AL 7 LEG-1D</p>	 <p>LIN-1I</p> <p>LIN-1D</p>
	ATAL-JU-KIFERM-METEOR-RENZ	TANLOCKS		

PARA: FOR:	LINCE			
	 <p>•• FSH.</p> <p>•• MTIC.(L)</p> <p>• LAT.</p> <p>• ALU.</p> <p>• COL.</p> <p>B LIN-2</p> <p>C •LIN-3I</p> <p>R LIN-15I</p>	 <p>LIN-4</p> <p>N LIN-4I</p> <p>C LIN-3D</p> <p>R ••LIN-15D</p>	 <p>LIN-14</p> <p>70-90</p> <p>N LIN-4D</p> <p>D LIN-5I</p> <p>T LIN-12I</p> <p>D1 LIN-18</p>	 <p>LAT.</p> <p>ALU.</p> <p>D LIN-5D</p> <p>T LIN-12D</p> <p>E LIN-6I</p> <p>D1 LIN-18D</p> <p>E LIN-17D</p>

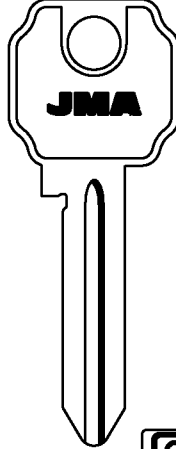
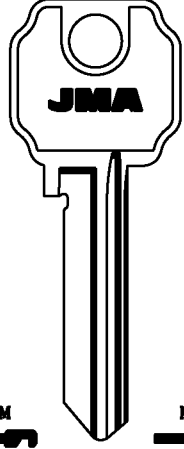
PARA: FOR:	LINCE			
	 <p>F LIN-7I</p>	 <p>J LIN-8I</p>	 <p>K LIN-9</p>	 <p>M LIN-10I</p> <p>S LIN-16</p>

Copyright by  
Alejandro Altuna S.A.  
2005

**JMA**

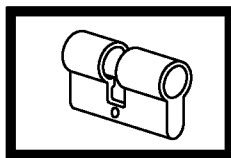

ATENCION:Concerniente a las marcas y denominaciones comerciales ver nota en indice.ATTENTION:Concerning the marks and commercial denominations see note in index. ATTENTION:Concernant les marques et denominations commerciales voir la note dans l'index.ACHTUNG:Beziehen auf die marke und handelsname sehen sie die notiz im index.

PARA:  
FOR:

### LINCE

**PARA-FOR:**

**LINCE (E)**

**LIPS (NL)**

**LITTO (B)**

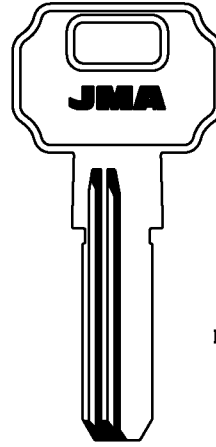
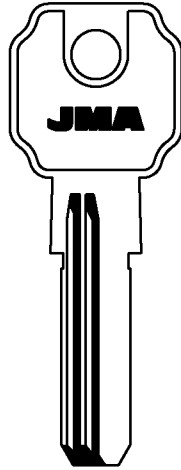
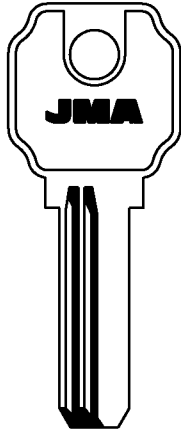

ALP.

LAT.

LAT.

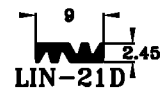
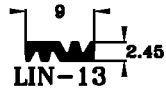

PARA:  
FOR:

### LIPS

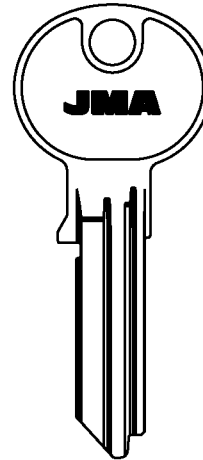
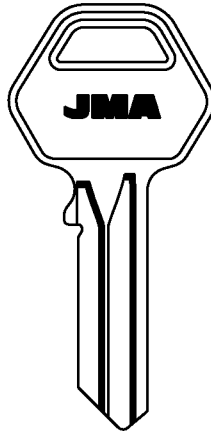
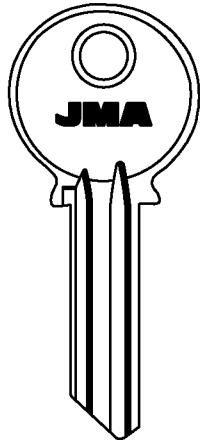
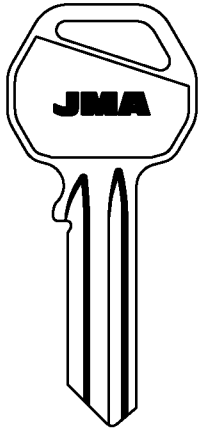

ALP.



PARA:  
FOR:

### LIPS

### LITTO

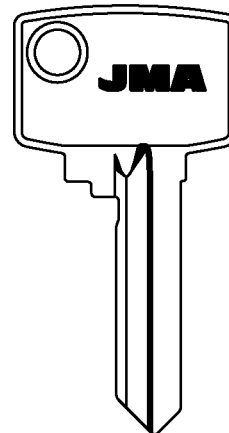
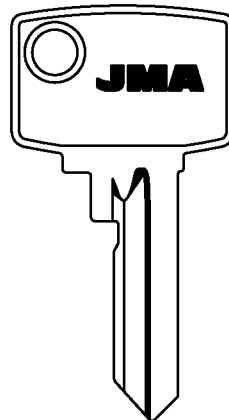
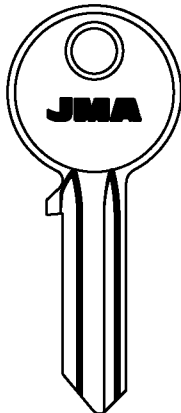
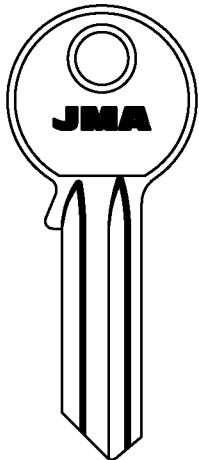

ALU.



ANKERSLOT

Copyright by  
Alejandro Altuna S.A.  
2005



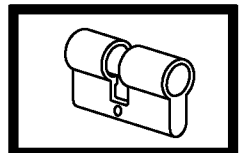





**JMA**

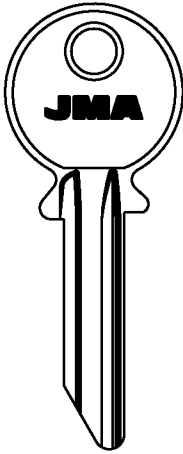
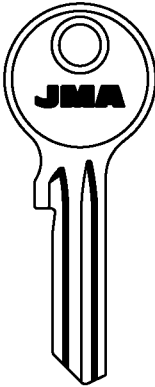
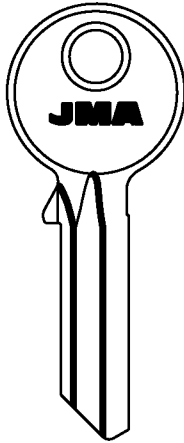
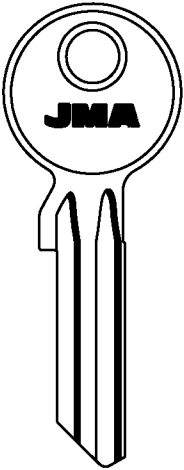









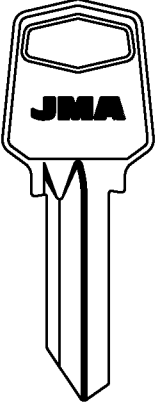
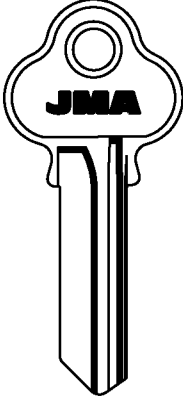
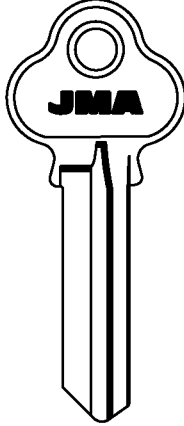
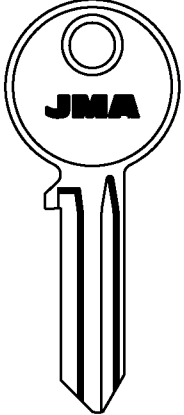













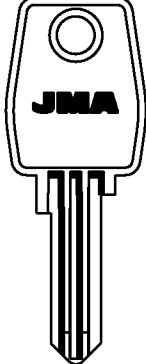
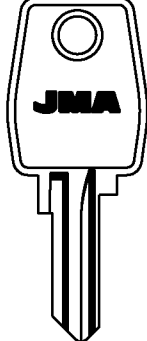

**69**

**PARA-FOR:**

- LITTO (B)**
- LOB (PL)**
- LOCK (MEX)**
- LOCKWOOD (AUS)**
- LOGO (I)**
- L. & F. (GB)**

<b>PARA: FOR:</b>	<b>LITTO</b>	<b>LOB</b>		
				
	 LIT-5I  LIT-5D <b>BKS</b>	 LB-1  LB-1D <b>EXPRES</b>	 LB-2D <b>BRICARD-EXPRES-REDY-YETI</b>	 LB-3  LB-3D

<b>PARA: FOR:</b>	<b>LOCK</b>	<b>LOCKWOOD</b>		<b>LOGO</b>
				
	ACE. LAT.   LOC-1D 	LAT.  O AL 9 A  LWO-1  LWO-1D <b>GAINSBOROUGH</b>		ALU.  O AL 9 A  LWO-2D  50-60  LO-1I  LO-1D  LO-3D <b>CISA</b>

<b>PARA: FOR:</b>	<b>LOGO</b>	<b>LOWE &amp; FLETCHER</b>			
					
	 LO-2I  LO-2D  30-40  LO-4D <b>CISA</b>	18 mm   90...1-200 ...1-400 91...201-275 GH...1-4000 SS...1-400 91...276-350  LF-1I  LF-1D <b>CEM-EURO LOCKS-UNION</b>		95001-97000 97001-99000  LF-2  LF-12  LF-12D <b>BICICLETTE CYCLES</b> <b>DOBLE SAFE-EURO LOCKS</b>	 LF-4I <b>EURO LOCKS</b>

Copyright by  
Alejandro Altuna S.A.  
2005  
**JMA**

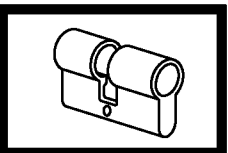

**70**

PARA:  
FOR:

# LOWE & FLETCHER

PARA-FOR:

L. & F. (GB)

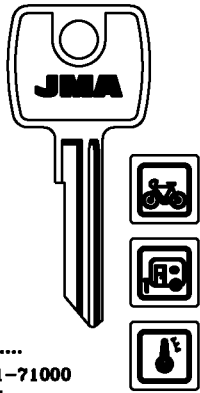

....  
70001-71000  
M....  
70001-71000

LF-5 LF-5D

LF-32

TELFORD

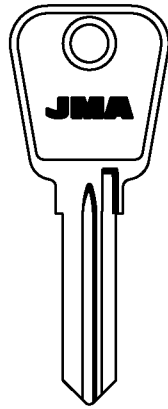

....  
66001-67200 81001-87000

LF-7 LF-7D

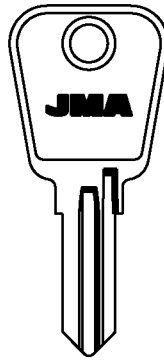

93...201-400  
....93901-94000

LF-8 LF-8D

LF-11 LF-11D

EURO LOCKS-MIBRA-UTZ

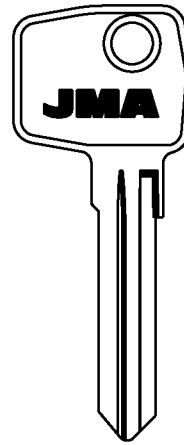

93...401-900  
....90901-90975

LF-10

EURO LOCKS

PARA:  
FOR:

# LOWE & FLETCHER

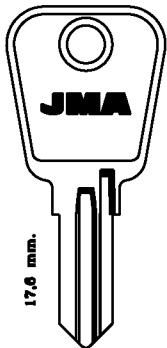

93...201-400  
....93901-94000

LF-13 LF-13D

MIBRA-UTZ

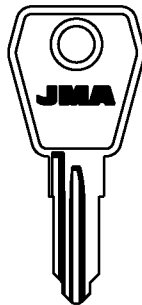

LF-14D

EURO LOCKS



60... 001-200  
60... 001-200  
90... 001-200  
...1-400  
GHM...1-155  
M...1-400  
RV...1-400  
RVM...1-400  
SP...1-400  
99...1-400

LF-15 LF-15D

FFE  
001-100  
LF-17

CEM-EURO LOCKS-ULTRA-UNION

PARA:  
FOR:

# LOWE & FLETCHER

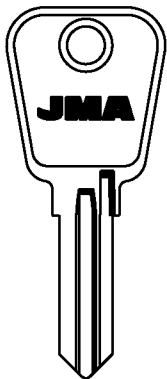

LF-16

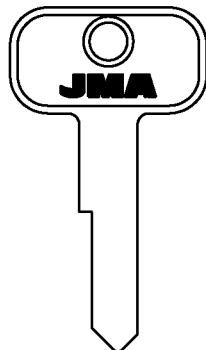

LF-18D

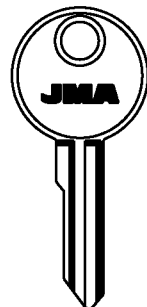

LF-19

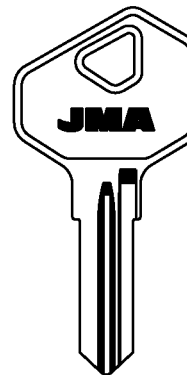

19...1-420  
....17001-19000  
....7001-9000

LF-20

Copyright by  
Alejandro Altuna S.A.  
2005

# JMA

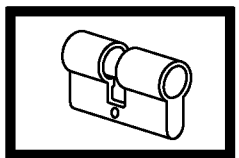

# 71

**PARA-FOR:**

**L. & F. (GB)**

**PARA:  
FOR:**

**LOWE & FLETCHER**

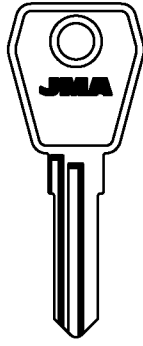

.....35000-35499  
.....78000-78999  
.....79000-79999  
  
LF-21



LF-22

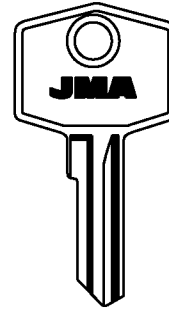

LF-23  
ULTRA

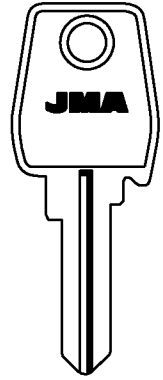

LF-24  
DOBLE SAFE-EURO LOCKS

**PARA:  
FOR:**

**LOWE & FLETCHER**

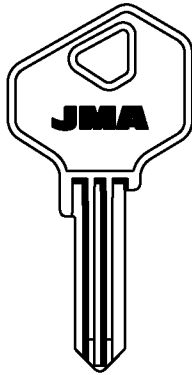

V..1-88  
  
LF-25

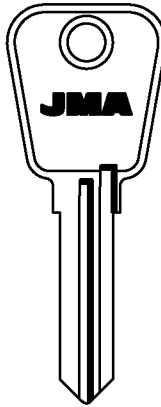

LF-26



LF-27  
EURO LOCKS

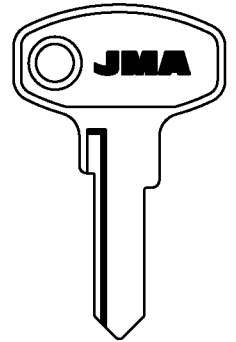

LF-28  
EURO LOCKS

**PARA:  
FOR:**

**LOWE & FLETCHER**

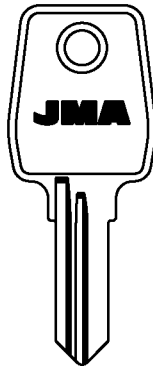

93...401-900  
.....90901-90975  
  
LF-29D

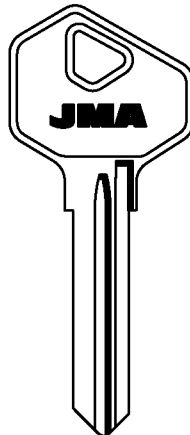

09...1-900  
29...1-478  
  
LF-30

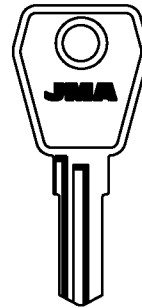

LF-31



LF-34

EURO LOCKS

Copyright by  
Alejandro Altuna S.A.  
2005

**JMA**

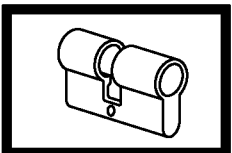

**72**

PARA: L. & F.  
FOR:

LUCKY

PARA-FOR:

L. & F. (GB)

LUCKY (RC)

LUMA (E)

LYF (E)

MARIANI (I)

MARQUES (P)

MASTER (USA)

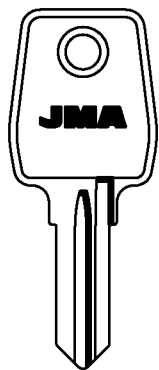

R...201-600  
....9001-9494

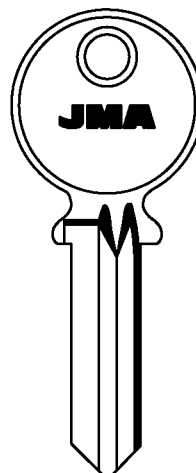
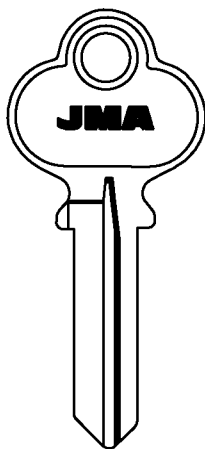

PARA: LUMA  
FOR:

LYF

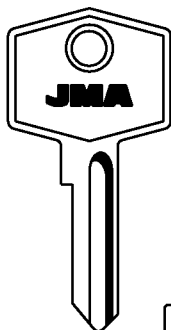

A1101-A1112 A2201-A2212 C5501-A5512 C6601-C6612

LUMA-1I LUMA-1D LUMA-3I LUMA-3D

B3301-B3312 B4401-B4412

LUMA-2I LUMA-2D LUMA-4I LUMA-4D

BASTA

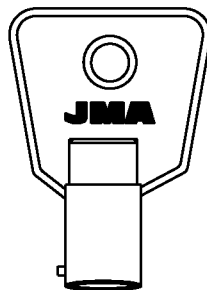

LAT.



LYF-1T

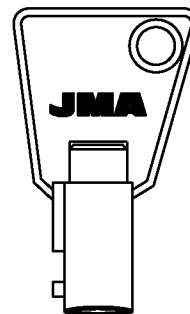

LAT.



LYF-2T

PARA: MARIANI  
FOR:

MARQUES

MASTER

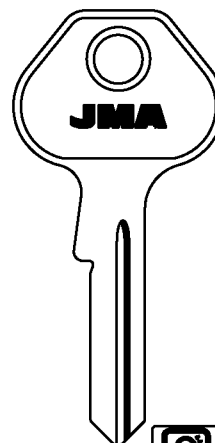
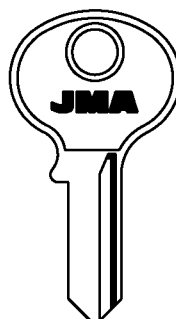
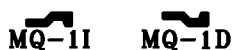
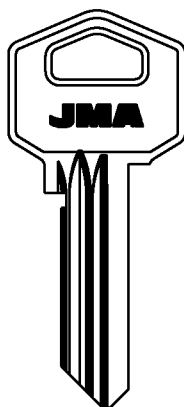

7000  
MAS-2D

Copyright by  
Alejandro Altuna S.A.  
2005

JMA

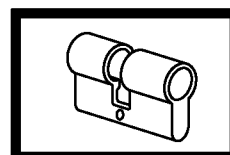

73

**PARA-FOR:**

**MASTER (USA)**

**MCL (RUS)**

**MCM (E)**

**PARA: FOR: MASTER**

**PARA: FOR: MASTER**

**PARA: FOR: MASTER**

**MCL**

**MCM**

Copyright by Alejandro Altuna S.A. 2005

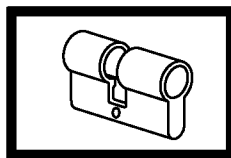

**74**

PARA:  
FOR:

### MCM

PARA-FOR:

MCM (E)

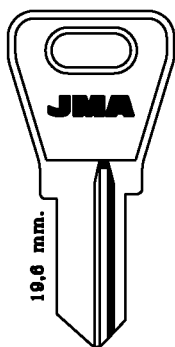

19,6 mm.

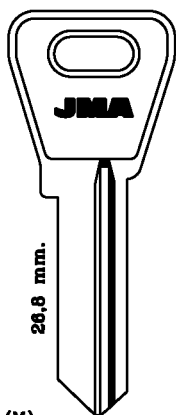

ALU.  
LAT.  
COL.  
FSH.  
•MTIC.(M)

26,8 mm.

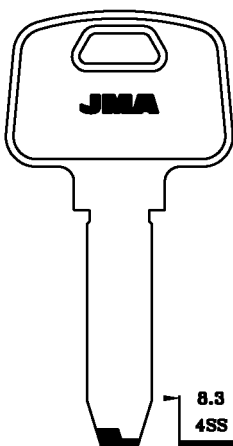

• ALU.  
• LAT.  
• FSH.

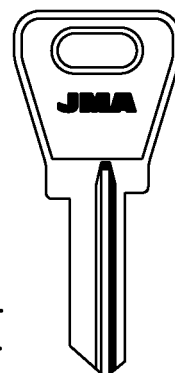

8.3  
4SS  
2.3  
MCM-4SS



MCM-3I MCM-3D



MCM-4I MCM-4D •

ESAFE-K+K



MCM-11S

LOB-YETI



MCM-5I • MCM-5D

COFER

PARA:  
FOR:

### MCM

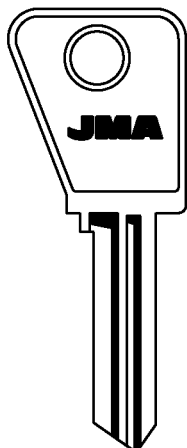

MCM-6

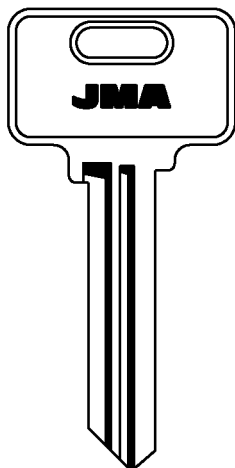

MCM-7

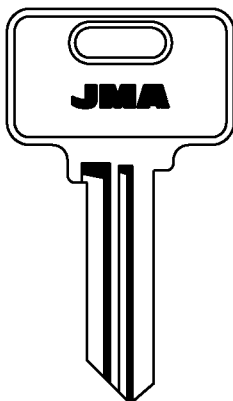

MCM-8

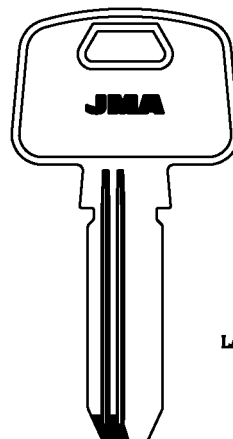

LAT.

9.67  
4SE  
2.35  
MCM-10

ESAFE-TROMER

PARA:  
FOR:

### MCM

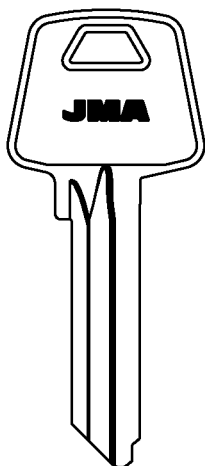

MCM-12D

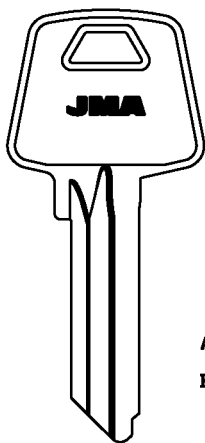

MCM-13D

ALU.  
FSH.

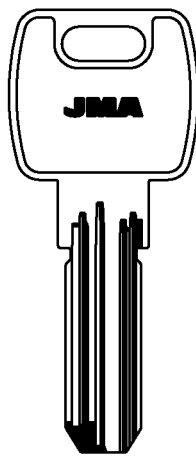

LAT.

9.7  
E8  
2.8  
MCM-16

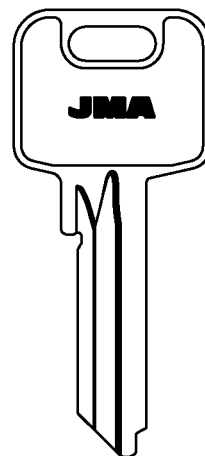

E-1  
MCM-18D

Copyright by  
Alejandro Altuna S.A.  
2005

# JMA

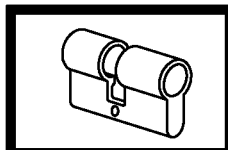

## 75

**PARA-FOR:**







**MCM (E)**



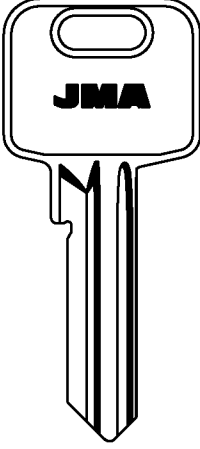
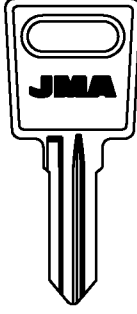
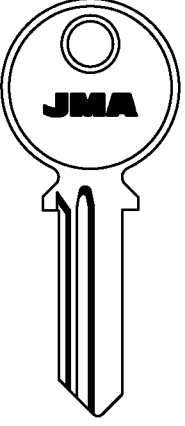

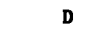
**ME-FA (RC)**





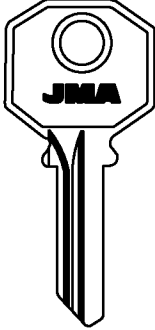
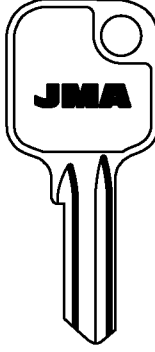
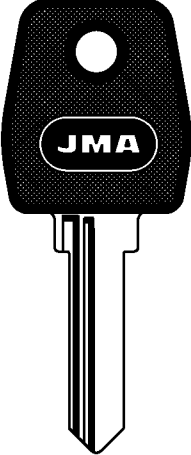





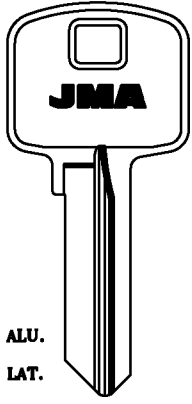







**MECO (D)**

**MELSMETALL (D)**

**MERONI (I)**

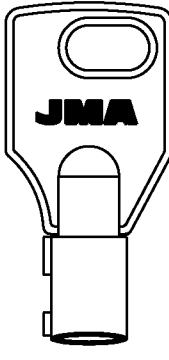
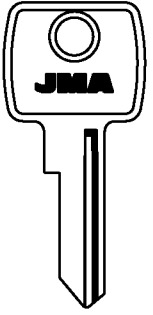
PARA: FOR:	MCM	ME-FA	MECO
			
	<p>B</p>  <p>MCM-24B</p> <p>C</p>  <p>MCM-24C</p> <p>D</p>  <p>MCM-24D</p> <p>E</p>  <p>MCM-24E</p> <p>F</p>  <p>MCM-24F</p>	<p>...1-100</p>  <p>BRA-1</p> <p>BRABANTIA-CLAUSOR</p>	 <p>MEC-5D</p>

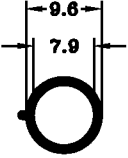
PARA: FOR:	MELSMETALL			
				
	 <p>MEL-1</p> <p>MEL-4</p> <p>MEL-4D</p>	 <p>MEL-2D</p>	 <p>MEL-3</p> <p>HBC</p>	 <p>MEL-5.P</p>





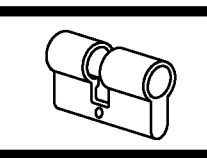





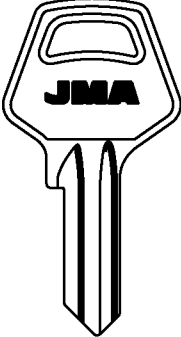
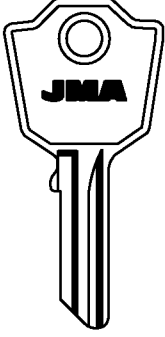
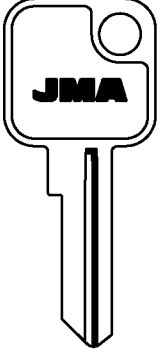
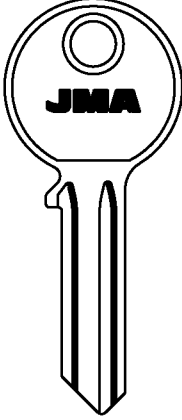





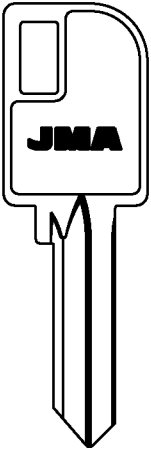
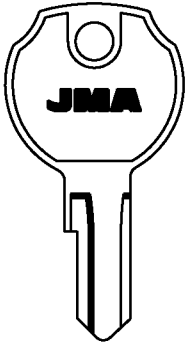
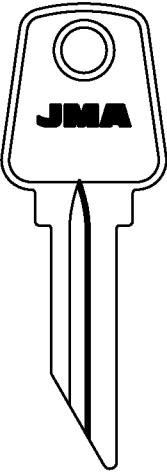
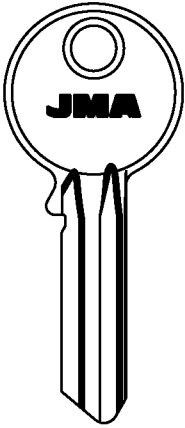

PARA: FOR:	MERONI			
		<p>B1</p>  <p>MER-21</p> <p>B2</p>  <p>MER-31</p> <p>B3</p>  <p>MER-41</p> <p>C1</p>  <p>MER-81</p> <p>C2</p>  <p>MER-71</p> <p>C3</p>  <p>MER-81</p> <p>D1</p>  <p>MER-101</p> <p>D2</p>  <p>MER-111</p> <p>D3</p>  <p>MER-121</p> <p>BM</p>  <p>MER-51</p> <p>CM</p>  <p>MER-91</p> <p>DM</p>  <p>MER-131</p> <p>GM</p>  <p>MER-141</p>		
	<p>ALU.</p> <p>LAT.</p> <p>T</p> <p>O AL 9</p> <p>M</p> <p>O AL 9</p>  <p>MER-1D</p>	<p>MER-1T</p> <p>9.6</p> <p>7.9</p>  <p>MER-1T</p>	 <p>MER-15</p>	

Copyright by  
Alejandro Altuna S.A.  
2005

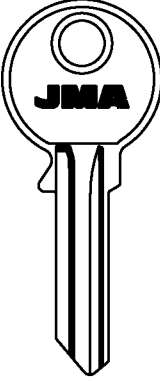
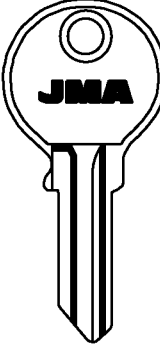
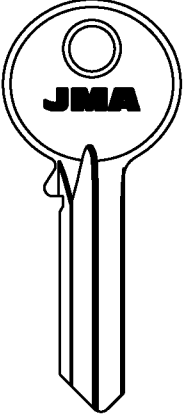
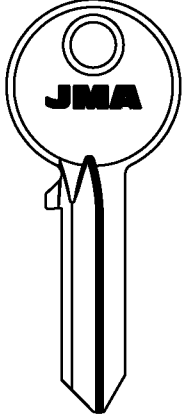
**76**

ATENCION:Concerniente a las marcas y denominaciones comerciales ver nota en indice.ATTENTION:Concerning the marks and commercial denominations see note in index. ATTENTION:Concernant les marques et denominations commerciales voir la note dans l'index.ACHTUNG:Beziehen auf die marke und handelsname sehen sie die notiz im index.

<b>PARA:</b> <b>FOR:</b>		<b>MERONI</b>		<b>METAL</b>		<b>PARA-FOR:</b>									
															
<p>1001-1500</p>  <b>MER-16</b>  <b>MER-16D</b>		<p>G....3001-3480 G...0-480 ....3001-3480</p>  <b>MER-17</b>		 <b>MER-18</b>		 <b>MTL-1</b>									
<b>LAMA</b>		<b>LAMA</b>		<b>PREMI-APRI</b>											
<b>PARA:</b> <b>FOR:</b>		<b>METALUX</b>		<b>METEOR</b>		<b>METIZ</b>		<b>MG (MONTI)</b>							
															
 <b>MET-2D</b>		<p>B...1-600 G...1-600</p>  <b>MTO-1</b>		 <b>MEZ-1D</b>		 <b>MGA-1</b>  <b>MGA-1D</b>									
<b>CAS-CISMA</b>															
<b>PARA:</b> <b>FOR:</b>				<b>MICHEL SEAT</b>				<b>MILA</b>							
															
 <b>MCH-1</b>		 <b>MCH-1D</b>		 <b>MCH-2</b>		 <b>MCH-2D</b>		 <b>MI-1D</b>				 <b>MI-2D</b>			
<b>OMR-POTENT</b>				<b>AM-POTENT</b>											

Copyright by  
Alejandro Altuna S.A.  
2005

**JMA**

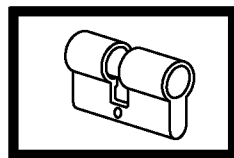

**77**

**PARA-FOR:**







**MILA (DK)**



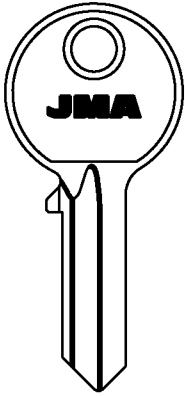
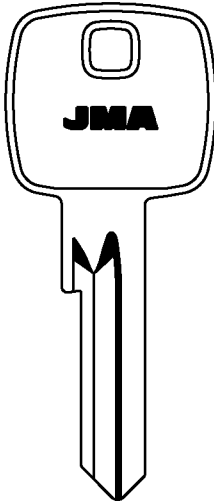
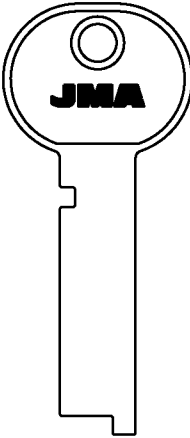
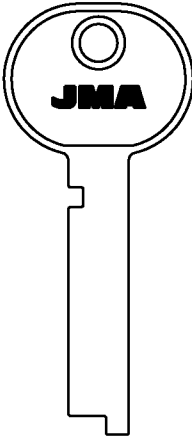
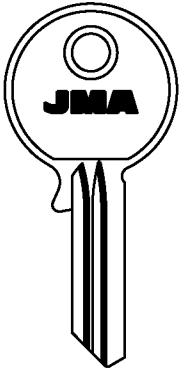

**MILES (RUS)**



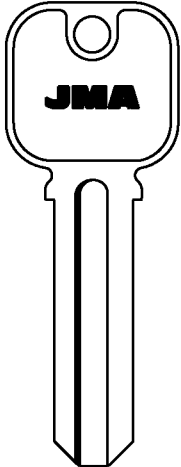
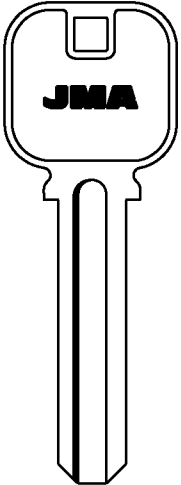
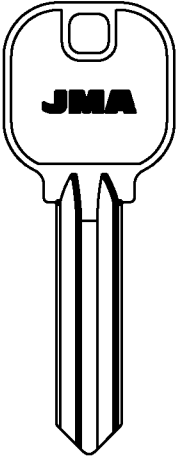
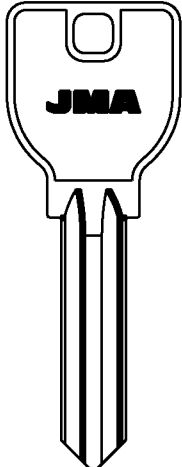

**MING-TAY (RC)**

**MIWA (J)**

**MLM (F)**

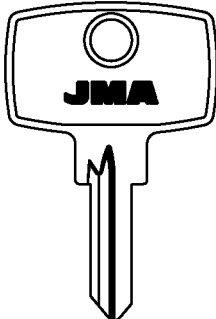
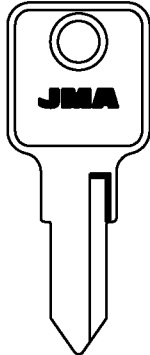
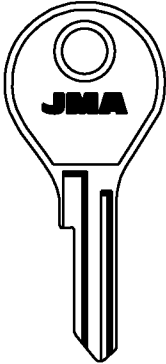
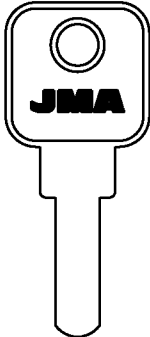
PARA: FOR:	MILA	MILES	MING-TAY
	 	 	
	 MI-3D  MI-4D	 MIL-1  MIL-2	 MIN-1D

PARA: FOR:	MIWA			
				
	 MIW-1	 MIW-2	 MIW-3 <small>1-2-3-4 1-2-3-4-5</small>	 MIW-4 <small>1-2-3-4 1-2-3-4-5</small>

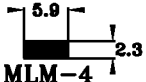

PARA: FOR:	MLM			
				
	 MLM-1D DOM-STUV	 MLM-5 DOM-STUV	 MLM-3 DOM-STUV	 MLM-4 <small>5.9 2.3</small>

Copyright by  
Alejandro Altuna S.A.  
2005

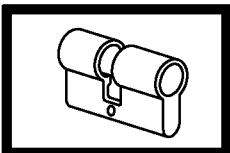
**JMA**



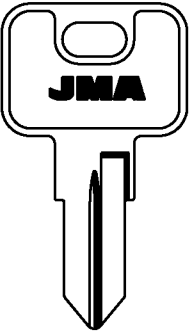
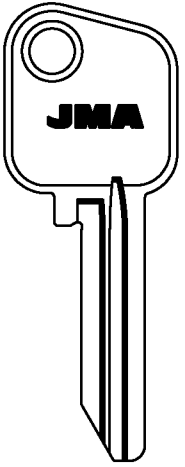
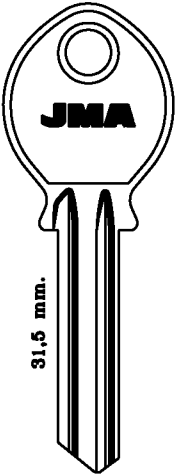
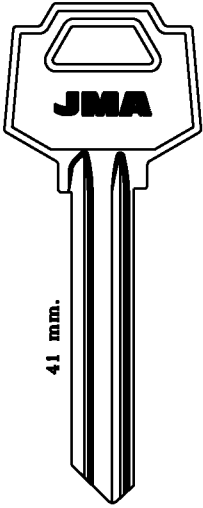
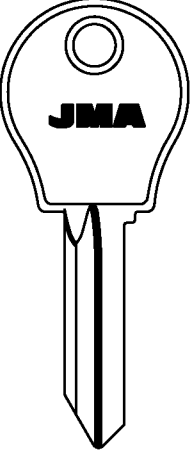
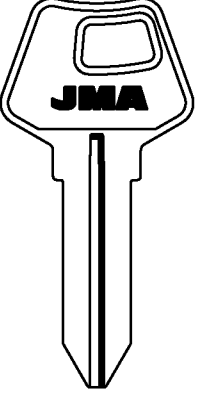
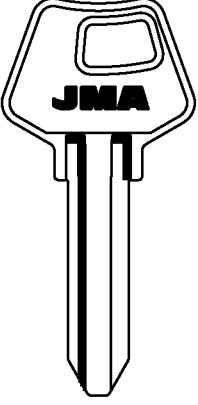
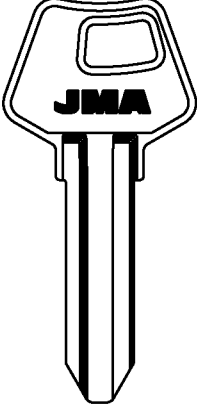
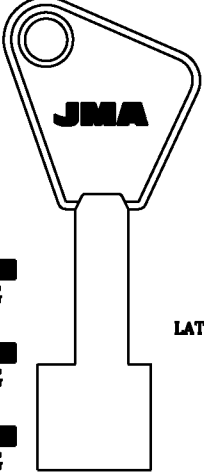
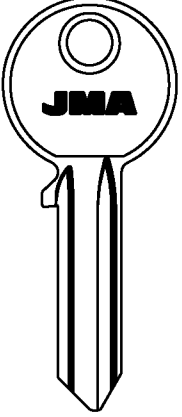

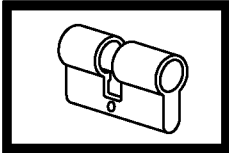





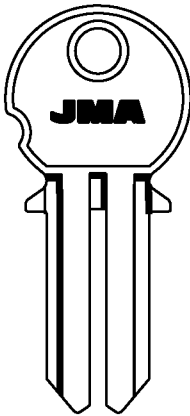

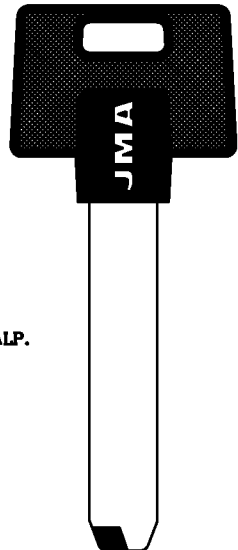



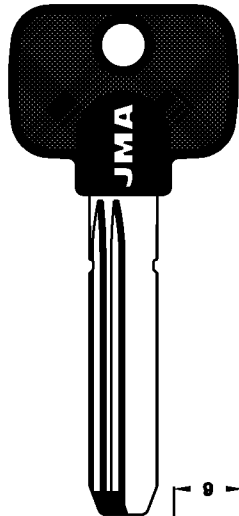

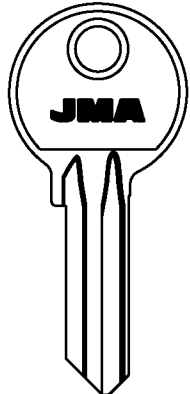

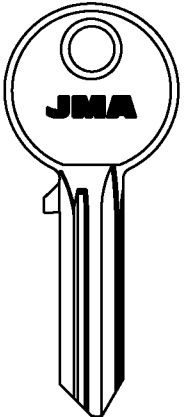

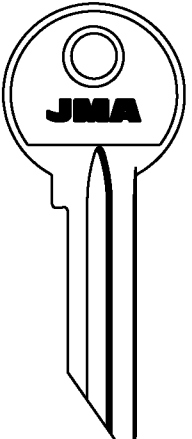

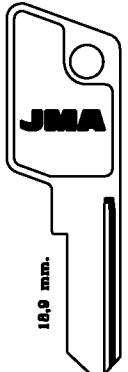

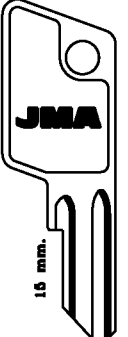

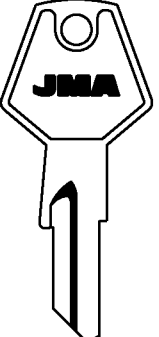
**78**

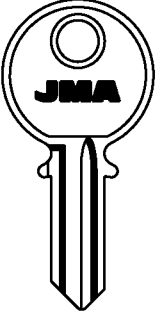
<p><b>PARA:</b> MOBELLA <b>FOR:</b></p>  <p>MBL-1    MBL-1D</p>	<p><b>MOGILEV</b></p>  <p>MOG-1D</p>	<p><b>MON</b></p>  <p>31.5 mm.</p>  <p>41 mm.</p> <p>MON-1I    MON-1D    MON-2I    MON-2D</p>		<p><b>PARA-FOR:</b></p> <p><b>MOBELLA (S)</b></p> <p><b>MOGILEV (RUS)</b></p> <p><b>MON (E)</b></p> <p><b>MONOBLOC (F)</b></p> <p><b>MOSRENTGUEN (RUS)</b></p> <p><b>MOTTURA (I)</b></p> <p><b>M.P. PLODARI (I)</b></p>
<p><b>PARA:</b> MONOBLOC <b>FOR:</b></p>  <p>MNO-1D FO</p>	<p><b>MOSRENTGUEN</b></p>    <p>MR-1    MR-2    MR-3</p>			
<p><b>PARA:</b> MOTTURA <b>FOR:</b></p>  <p>MT-AG    MT-CG    MT-EG    MT-GG</p> <p>LAT.</p>		<p><b>M.P. PLODARI</b></p>  <p>MP-1I    MP-1D</p>		<p>Copyright by Alejandro Altuna S.A. 2005</p>   <p><b>79</b></p>
<p>ATENCION:Concernente a las marcas y denominaciones comerciales ver nota en indice.ATTENTION:Concerning the marks and commercial denominations see note in Index. ATTENTION:Concernant les marques et denominations commerciales voir la note dans l'index.ACHTUNG:Beziehen auf die marke und handelsname sehen sie die notiz im Index.</p>				

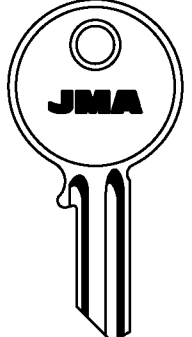
**PARA-FOR:**

- MSV (P)**
- MUL.T.LOCK (IL)**
- NOVA (D)**
- OCTAVO M. (RUS)**
- OFITA (E)**
- OJMAR (E)**

	<b>PARA:</b> MSV <b>FOR:</b>	<b>MUL.T.LOCK</b>		
	  <b>MSV-1</b>  <b>MSV-2</b>	 ALP.	 <b>MUL-T2.P</b>  <b>MUL-T3.PL</b>  <b>MUL-T4.P</b>  <b>MUL-T5.P</b>	 ALP.  <b>MUL-T3.P1</b> GAMMA
<b>PARA:</b> MUL.T.LOCK <b>FOR:</b>	<b>NOVA</b>	<b>OCTAVO M.</b>	<b>OFITA</b>	
  <b>MUL-T6</b>  <b>MUL-T6D</b>	  <b>NO-1</b> ABUS-TOP	  <b>8M-1D</b>	 10,9 mm.  <b>OF-1</b>	
<b>PARA:</b> OFITA <b>FOR:</b>	<b>OJMAR</b>			
 15 mm.  <b>OF-2</b>	  <b>OJ-1D</b>	  <b>OJ-2I</b>	  <b>OJ-3I</b>  <b>OJ-3D</b>  <b>OJ-7I</b>	

Copyright by  
Alejandro Altuna S.A.  
2005

**JMA**

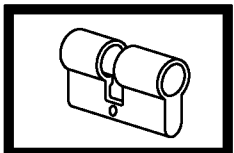

**80**

PARA:  
FOR:

### OJMAR

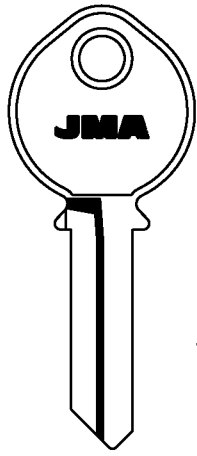

ALU.

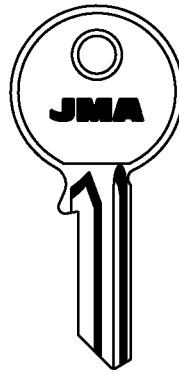
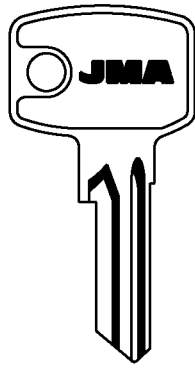

OJ-4D

OJ-5I

OJ-6I

OJ-6D

J  
 OJ-J

L  
 OJ-L

K  
 OJ-K

M  
 OJ-M

**PARA-FOR:**

**OJMAR (E)**

**OLIVA (I)**

**OLIVETTI (I)**

**OMA (I)**

PARA:  
FOR:

### OJMAR

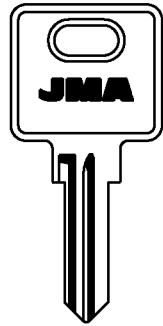
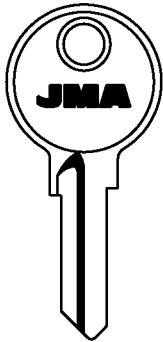

OJ-9D

HERO-KEMEN-RS

F  
 OJ-10

BURG-HRG-ISKU-KEMEN-MOFLEX-SISO-STUMPF METALL

F1  
 OJ-11

S  
 OJ-12

U  
 OJ-13

A1  
 OJ-16

B1  
 OJ-17

Y  
 OJ-14

Z  
 OJ-15

BURG

PARA:  
FOR:

OJMAR

OLIVA

OLIVETTI

OMA

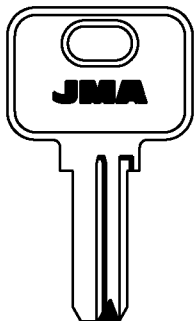

ALP.

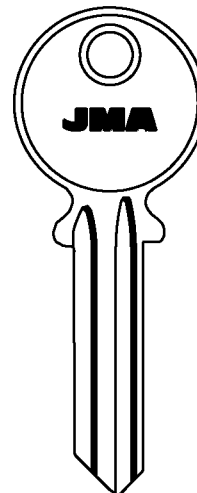
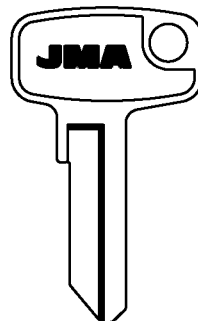
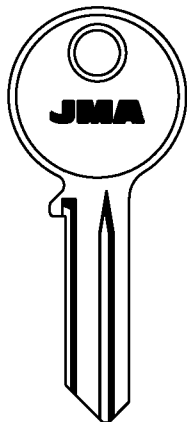

OJ-Q

OL-5D

FERMABLOCK-PB-PREFER

OLIV-1

OA-1

C.A.R.S.

Copyright by  
Alejandro Altuna S.A.  
2005

**JMA**

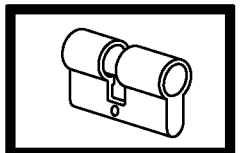

**81**

**PARA-FOR:**

PARA:  
FOR:

**OMEC**

**OMEC (I)**

**OMIV (I)**

**O.M.R. (I)**

**ORDO (F)**

**ORION NOVOX  
(F)**

**ORO (IL)**

**ORSHA (RUS)**

**P&C I. (USA)**

**PADO (BR)**

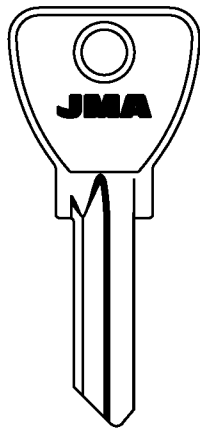

OMC-1D

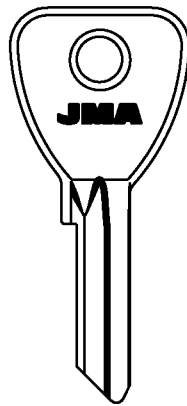

OMC-2D

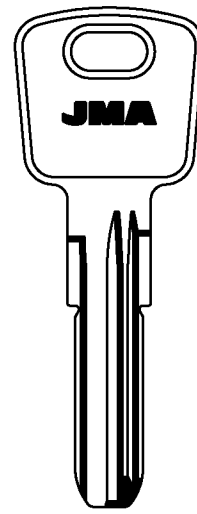

OMC-3  
SANTOS

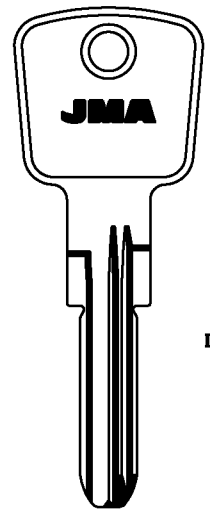

OMC-4

LAT.

LAT.

PARA:  
FOR:

**OMIV**

**O.M.R.**

**ORDO**

**ORION-NOVOX**

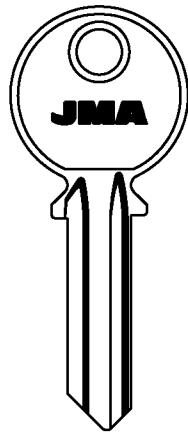

OMI-1 OMI-1D

CIB-STV

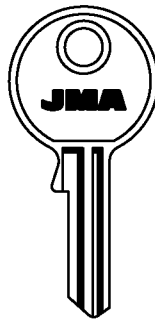

OM-1

MICHEL SEAT

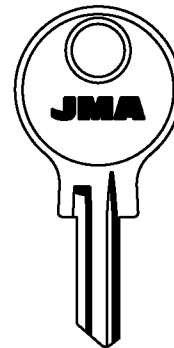

OR-11

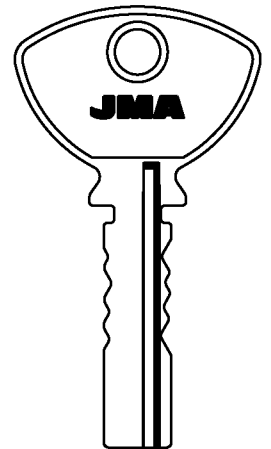

ON-11 ON-1D

DECAYEUX

PARA:  
FOR:

**ORO**

**ORSHA**

**P&C I.**

**PADO**

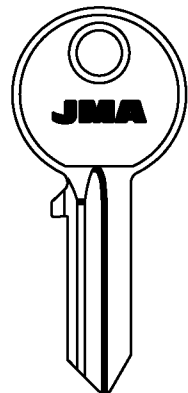

ORO-1D

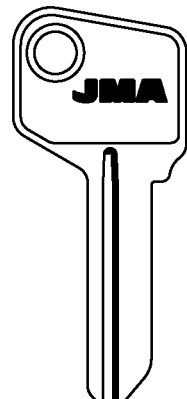

ORK-1D

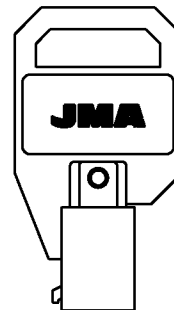

PCI-1T

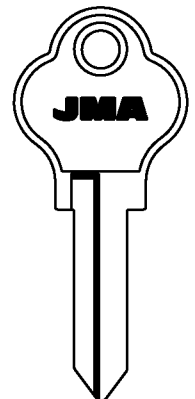

PAD-1D

Copyright by  
Alejandro Altuna S.A.  
2005

**JMA**

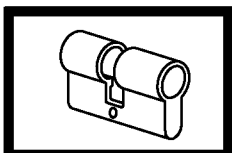

**PARA:** PADO  
**FOR:**

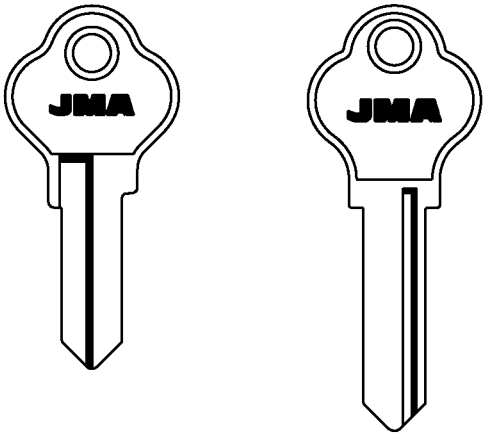

PAD-2D    PAD-3    PAD-3D

**PAPAIZ**

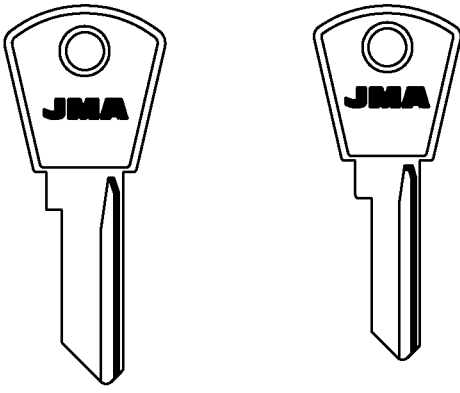

45-50-60-70    35

PAP-1    PAP-2

**PARA-FOR:**

**PADO (BR)**  
**PAPAIZ (BR)**  
**P.C. (I)**  
**PENZMASH (RUS)**

**PARA:** PAPAIZ  
**FOR:**

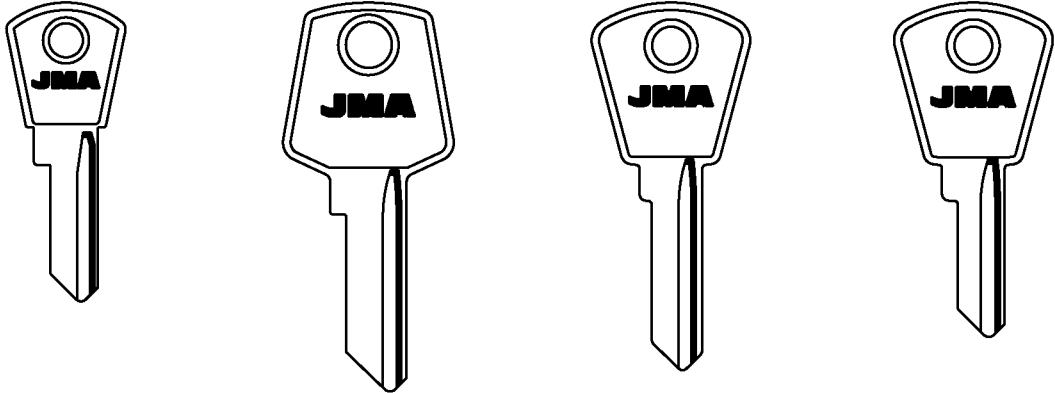

25-30    45-50-60-70

PAP-3    PAP-4    PAP-5    PAP-6

**PARA:** P.C.  
**FOR:**

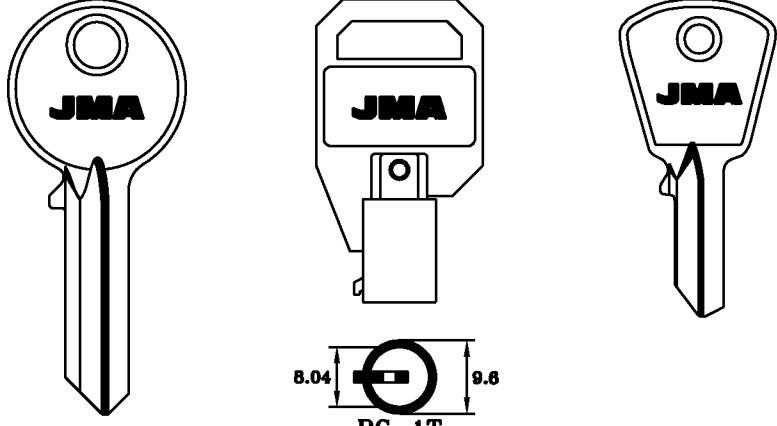

1 AL 5    8.04    9.6    8.04    9.6

PC-1D    PC-1T    PC-3T

**PENZMASH**

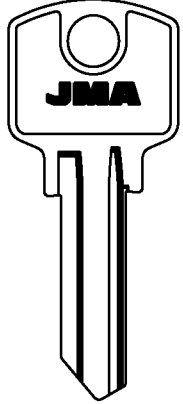

...1 AL 5

PEN-1    PEN-1D

Copyright by  
Alejandro Altuna S.A.  
2005

**JMA**

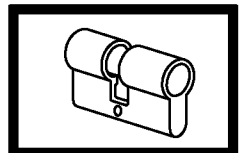

**83**

ETNA-FEB-FPB-FRAL-SANTOS

ATENCION:Concerniente a las marcas y denominaciones comerciales ver nota en indice.ATTENTION:Concerning the marks and commercial denominations see note in index.  
ATTENTION:Concernant les marques et denominations commerciales voir la note dans l'index.ACHTUNG:Beziehen auf die marke und handelsname sehen sie die notiz im index.

**PARA-FOR:**

PARA: PENZMASH PETROZAVODSK

PFAFFENHAIN

**PENZMASH  
(RUS)**

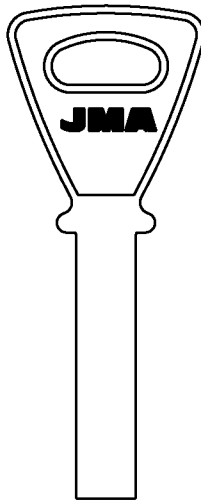

PEN-2

**PETROZAVODSK  
(RUS)**

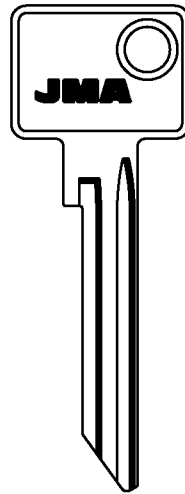

PET-1

**PFAFFENHAIN  
(D)**

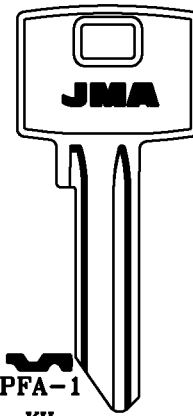

PFA-1  
KH  
PFA-2

PFA-5

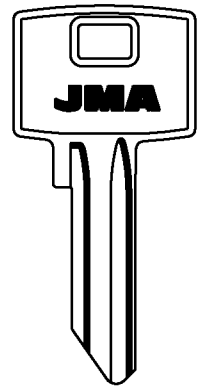

L  
PFA-3

**PHILLIPS  
(MEX)**

**PICARD (F)**

**POLLUX (F)**

**PREFER (I)**

PARA: PFAFFENHAIN PHILLIPS

PICARD

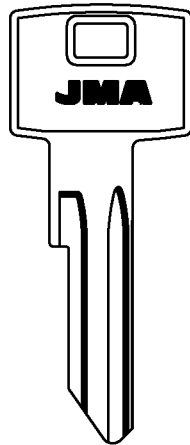

PFA-4

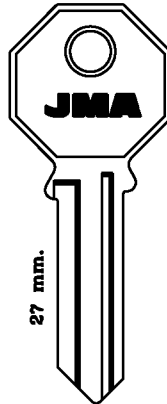

27 mm.

PHI-52

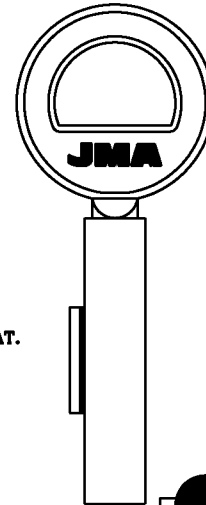

LAT.

PIC-1E

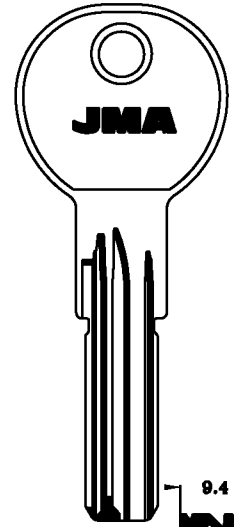

LAT.

9.4  
2.55

PIC-8D

ISEO

PARA: POLLUX

PREFER

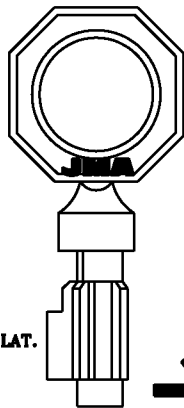

LAT.



POL-3TEC

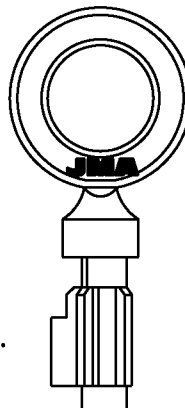

LAT.



POL-4E

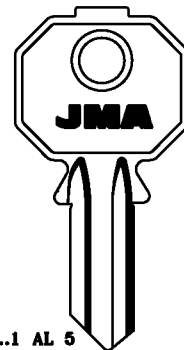

...1 AL 5

PR-1



PR-1D



PR-2



PR-3

UNIFOR

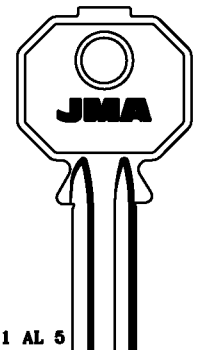

...1 AL 5

PR-4I



PR-4D



PR-10



PR-11

BLOCUS-CAP-CIB-JIP  
PASTORE-PROMO

Copyright by  
Alejandro Altuna S.A.  
2005

**JMA**

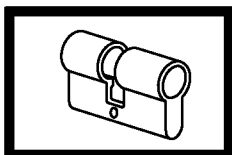

**84**

PARA:  
FOR:

PREFER

PARA-FOR:

PREFER (I)  
REGAL (GB)  
RENZ (D)

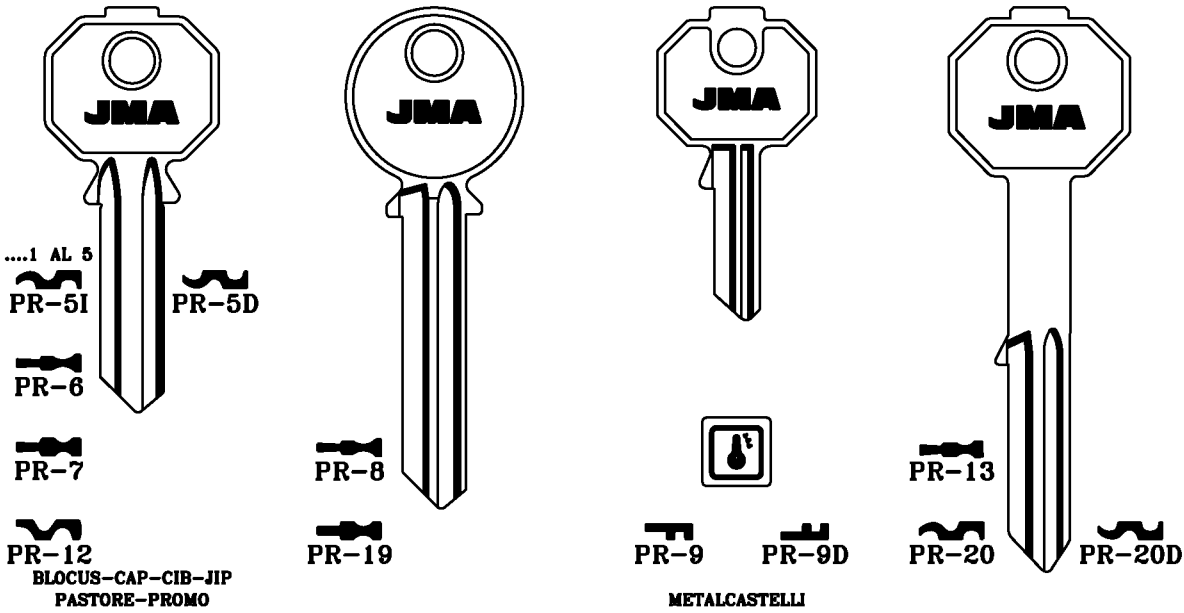

PARA:  
FOR:

PREFER

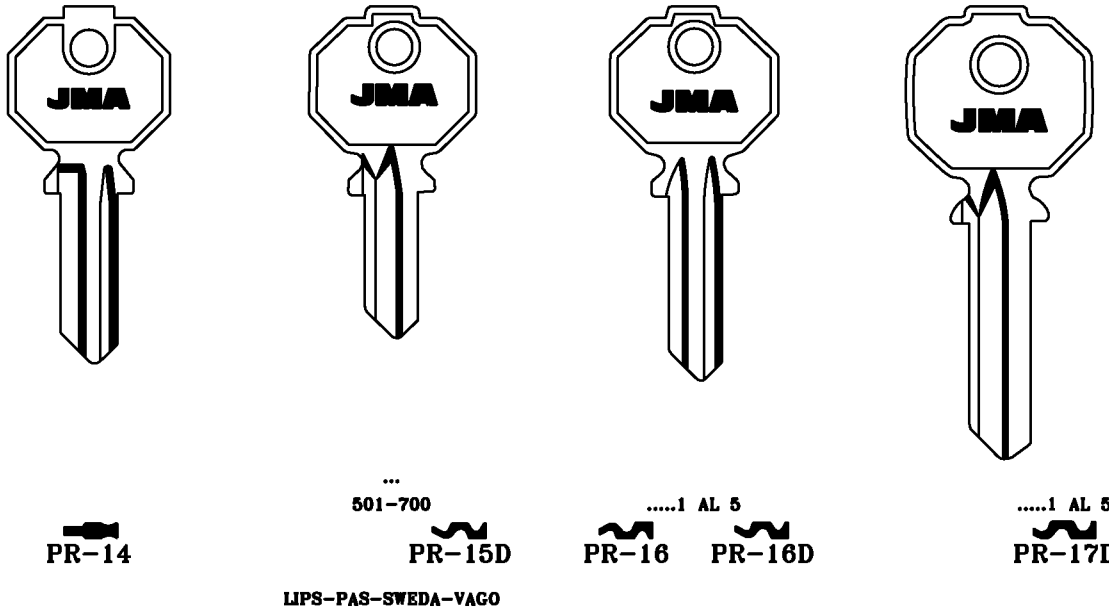

PARA: PREFER  
FOR:

REGAL

RENZ

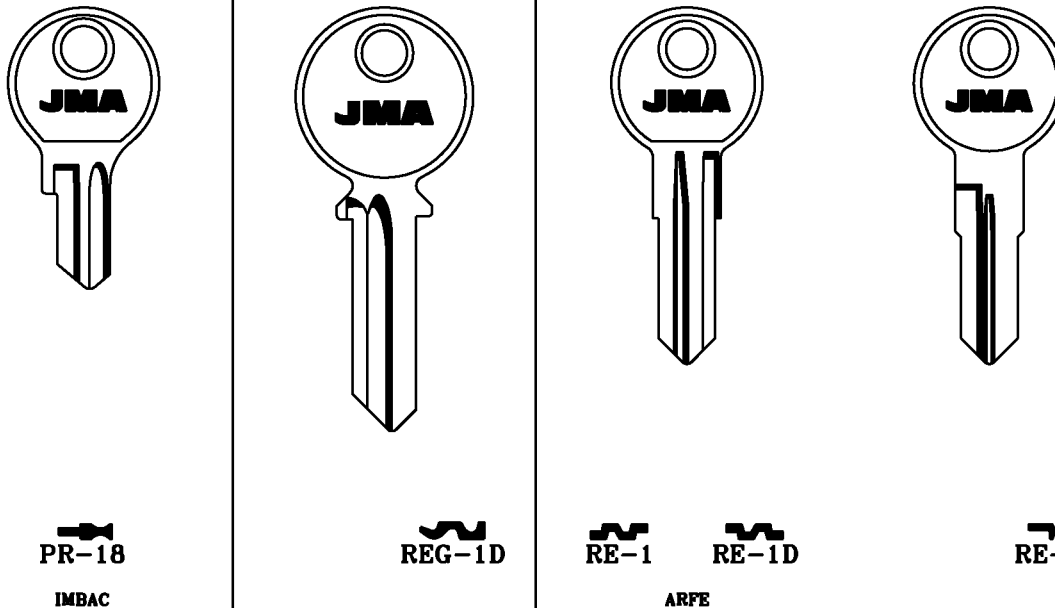





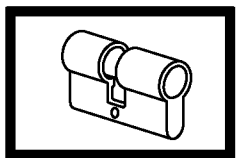







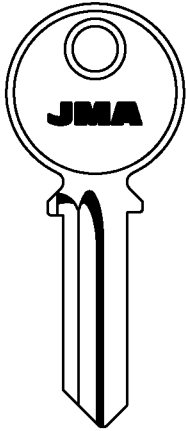

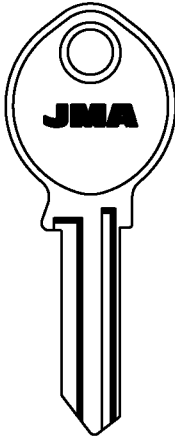

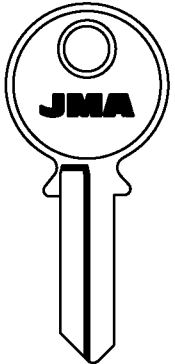

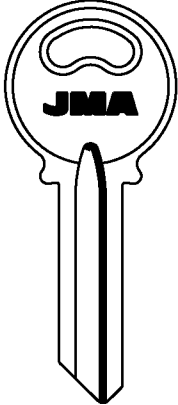

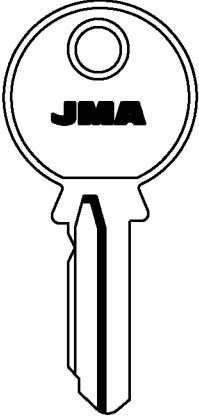

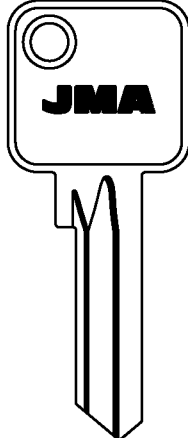

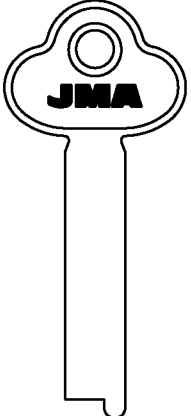
Copyright by  
Alejandro Altuna S.A.  
2005

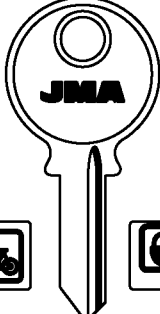
JMA

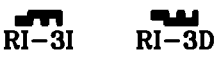

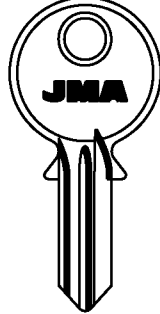
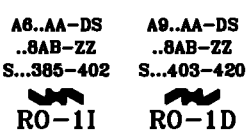
85

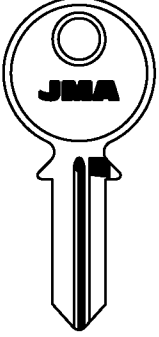
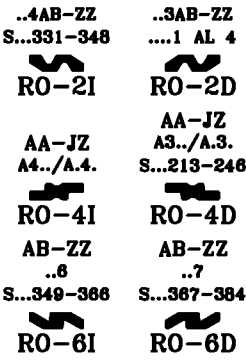
**PARA-FOR:**

PARA-FOR:	RENZ	REX	RGM			
RENZ (D)	 	 	 	 		
REX (DK)						
RGM (E)						
RIAZIAN (RUS)			 	 	 	 
RICOUARD (F)						
RIGA (RUS)						
RIL (E)						
RIPA (E)	    	   	   			
RONIS (F)						

Copyright by  
Alejandro Altuna S.A.  
2005

**JMA**

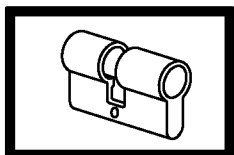

**86**

PARA:  
FOR:

### RONIS

PARA-FOR:

### RONIS (F)



ARMOR  
EMHART  
FORINDEX  
KARDEX  
MLM  
NEMEF  
RONEO  
SANEL STRAFOR  
SCHAFFER  
YAC

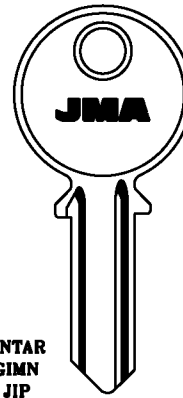

ANTAR  
GIMN  
JIP  
LAPERCHE  
PM  
SESA

...11 1-700  
A...A1-700  
C...101-800  
D...1-1000  
T...1-380  
...151-700  
E...1-1000  
T...107-400  
Y...101-800  
RO-7I  
RO-7D

T...1-380  
TA...1-224  
GV...1-300  
...F1-500  
1F..1-21  
RO-8I  
RO-8D  
F...1-600  
RO-30  
RO-30D  
RO-33  
RO-32D

...0 AL 8  
RO-9I  
RO-9D

PARA:  
FOR:

### RONIS

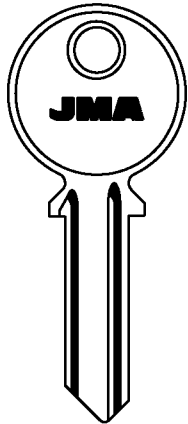

FM  
RO-18I  
LIONA LIOX-LAPERCHE

FL  
RO-19I  
LAPERCHE  
RO-19D

FK  
RO-20I  
FONTAINE-LAPERCHE  
RO-20D

ET  
RO-21I  
RO-21D

RO-22I

RO-23D

### RO-10D

ANTAR  
BLOCUS  
BAB  
DEBEAURAIN  
DELTA  
DERLOCHE  
DESPREZ  
DC  
EMGE  
EQUIBATIR  
FONTAINE  
FORINDEX  
GOLLOT  
GUIDOTTI  
JIP  
LAPERCHE  
LIONA-LIOX  
MAFOR  
MONDIAL  
MOREAUX  
NUMIDIA  
PM  
SESA  
STREMLER  
STUV  
VEGA

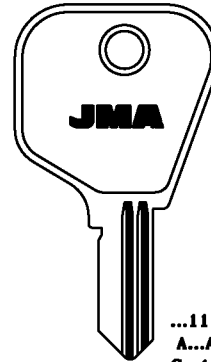

.....1 AL 9  
A/Z.....1 AL 8  
.....A/Z 1 AL 8  
MX.....1100-1699  
RO-10I  
RO-10D

...11 1-700  
A...A1-700  
C...101-800  
D...1-1000  
T...1-380  
...151-700  
E...1-1000  
T...107-400  
Y...101-800  
RO-11I  
RO-11D

ABSA-SADV-SIMPLEX

PARA:  
FOR:

### RONIS

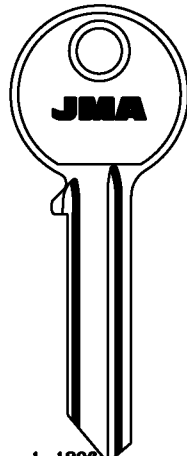
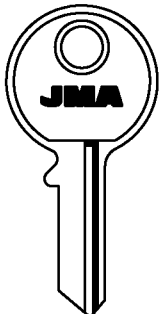

FM  
RO-25I  
LAPERCHE  
RO-25D

FL  
RO-26I  
LAPERCHE  
RO-26D

FK  
RO-27I  
LAPERCHE  
RO-27D

RO-28I  
RO-28D

RO-29D

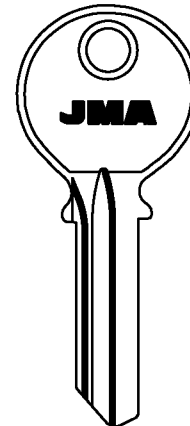

RO-31D

RO-12I  
RO-12D  
M...801-983  
TAV  
RO-16I  
RO-16D

BURG-STAFOR

ANTAR-LAPERCHE-SESA

SOLOR

Copyright by  
Alejandro Altuna S.A.  
2005

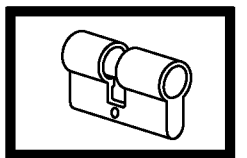

**PARA-FOR:**

**RONIS (F)**  
**RUKO (DK)**

**PARA:** RONIS  
**FOR:**

RO-34D      RO-36D      RO-37      RO-37D

CATOR      JD

**PARA:** RUKO  
**FOR:**

ALU.      DIFA      ASSA

RU-21      RU-2D      RU-3D      RU-5I      RU-5D      RU-K      RU-KD

RU-4D      RU-6I      RU-L

RU-10D      RU-9I      RU-9D      RU-M

SKB  
RU-11D

RU-12D

RU-14D

RU-15

.....1 AL 8  
.....1 AL 9  
.....1 AL 9 AL 0 A-B  
.....0 AL 9 A AL M  
S.....1 AL 9

**PARA:** RUKO  
**FOR:**

.....  
1 AL 9 A AL C  
RU-8D

GK  
RU-GK7

GL  
RU-GL7

GM  
RU-GM7







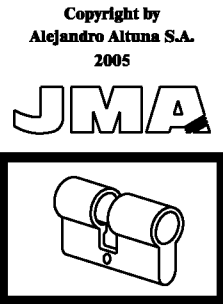



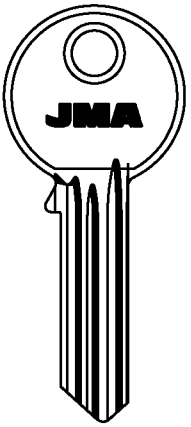





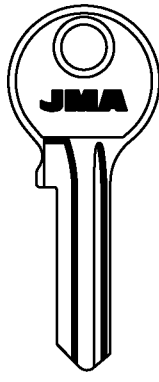
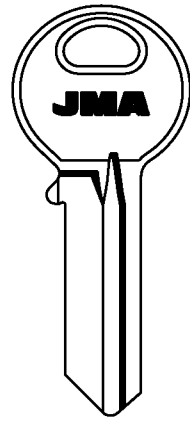

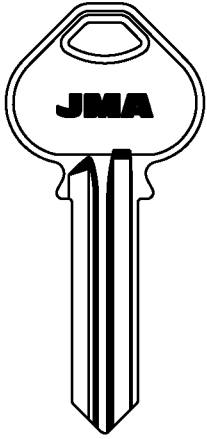
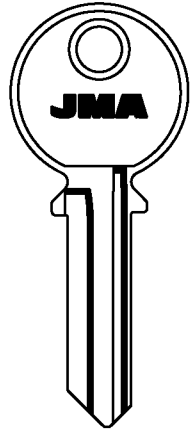

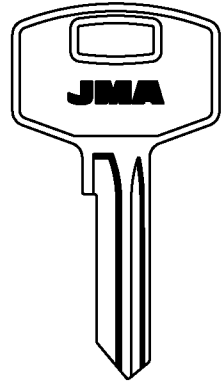

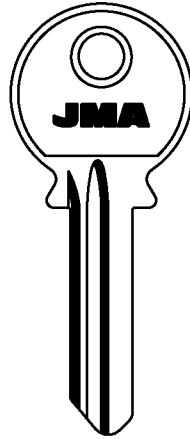
GS  
RU-GS7

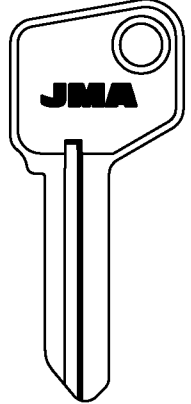
RU-7D      RU-13D

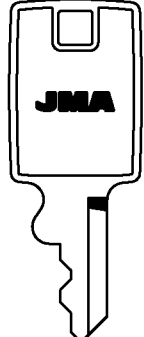
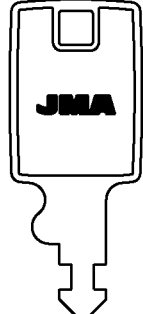
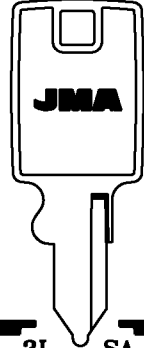
ASSA



ATENCION:Concerniente a las marcas y denominaciones comerciales ver nota en indice.ATTENTION:Concerning the marks and commercial denominations see note in index. ATTENTION:Concernant les marques et denominations commerciales voir la note dans l'index.ACHTUNG:Beziehen auf die marke und handelsname sehen sie die notiz im index.

<p><b>PARA:</b> <b>FOR:</b></p> <p style="text-align: center;"><b>RUKO</b></p>  <p style="text-align: center;">       GK          RU-GK        GL          RU-GL        GM          RU-GM        GS          RU-GS     </p> <p style="text-align: center;">       GC          RU-GC     </p> <p style="text-align: center;">       HNR          RU-16D     </p>	<p style="text-align: center;"><b>RUSSIA</b></p>   <p style="text-align: center;">       RSS-1     </p> <p style="text-align: center;">         RSS-2D     </p>		<p><b>PARA-FOR:</b></p> <p><b>RUKO (DK)</b></p> <p><b>RUSSIA (RUS)</b></p> <p><b>RUSSWIN (USA)</b></p> <p><b>SABT (KW)</b></p> <p><b>SAM (RUS)</b></p> <p><b>SAMSONITE (USA)</b></p>
<p><b>PARA:</b> <b>FOR:</b></p> <p style="text-align: center;"><b>RUSSWIN</b></p>   <p style="text-align: center;">LAT.</p> <p style="text-align: center;">         RUS-1     </p> <p style="text-align: center;">         RUS-2     </p>	<p style="text-align: center;"><b>SABT</b></p>  <p style="text-align: center;">         SABT-1     </p>	<p style="text-align: center;"><b>SAM</b></p>  <p style="text-align: center;">         SAM-1D     </p>	
<p><b>PARA:</b> <b>FOR:</b></p> <p style="text-align: center;"><b>SAM</b></p>  <p style="text-align: center;">         SAM-2D     </p>	<p style="text-align: center;"><b>SAMSONITE</b></p>    <p style="text-align: center;">       SE 041        SE 052        SE 083        SE 124        SE 165        SE 186          SA-4     </p> <p style="text-align: center;">       170 S          SA-1     </p> <p style="text-align: center;">         SA-1D     </p> <p style="text-align: center;">         SA-2     </p> <p style="text-align: center;">         SA-3I     </p> <p style="text-align: center;">         SA-3D     </p>		

Copyright by  
Alejandro Altuna S.A.  
2005

**JMA**

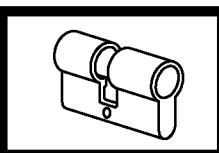

**PARA-FOR:**

PARA:  
FOR:

**SARGENT**

**SARGENT  
(USA)**

**SATURN (D)**

**SCHÄRER  
(USA)**

**SCHLAGE  
(USA)**

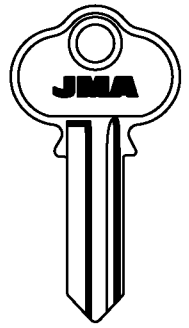
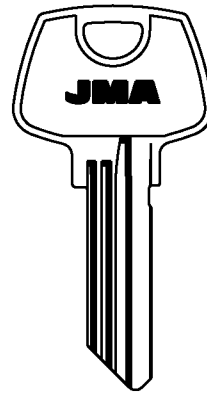
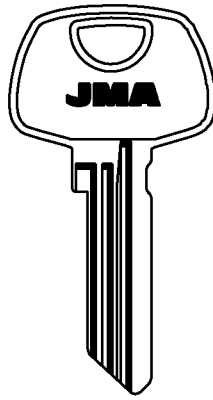
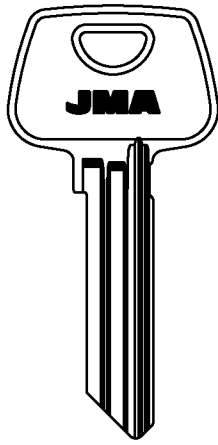

LAT.

LAT.

BRICARD-SHOWA

PARA:  
FOR:

**SARGENT**

**SATURN**

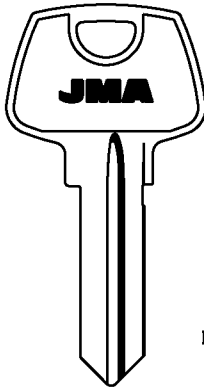

LAT.

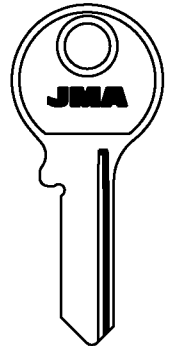
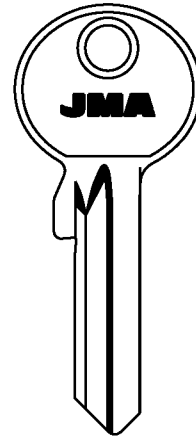
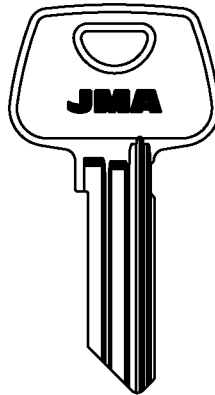

PARA:  
FOR:

**SCHÄRER**

**SCHLAGE**

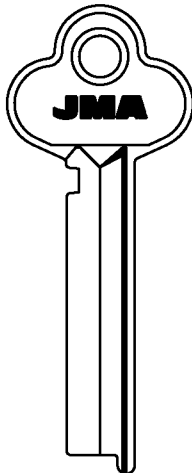

LAT.

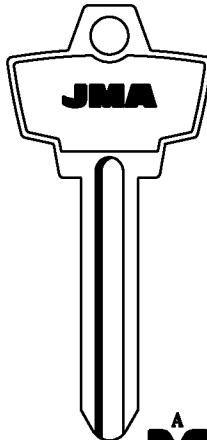

EPO

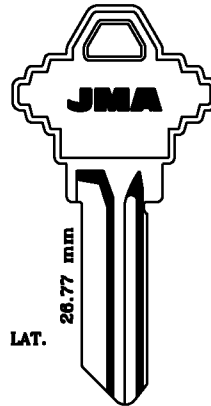

LAT.

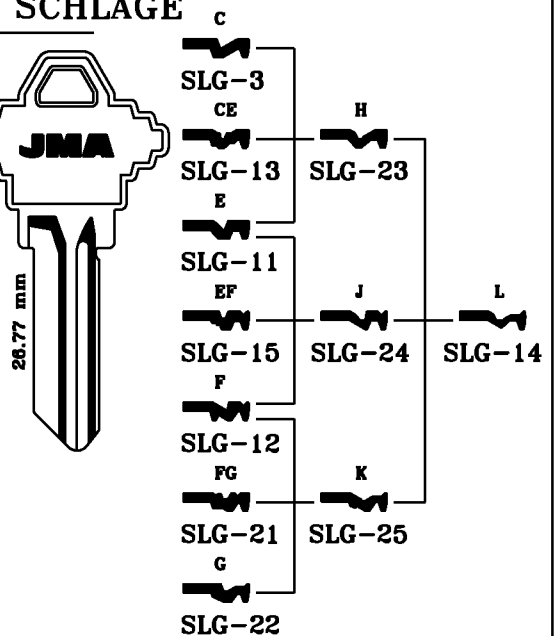

Copyright by  
Alejandro Altuna S.A.  
2005

**JMA**

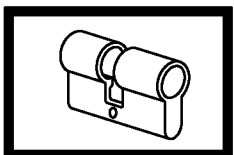

**90**

**PARA: FOR:**

**SCHLAGE**

30.73 mm

LAT.

**SCHLECHTENDAHL**

LAT.

SCH-1D

CASI-HUTRA-NORDWEST

**PARA-FOR:**

**SCHLAGE (USA)**

**SCHLECHTENDAHL (D)**

**SEA (CH)**

**SECURITAL (I)**

**SELECT (F)**

**SELIVANOVSK (RUS)**

**PARA: FOR:**

**SEA**

ALP.

LAT.

9.5

20-23

2.2

SEA-1

EZCURRA-HASLER-VIDMAR

.....1 AL 7

9.5

2.2

SEA-2

**SECURITAL**

ZAM.

5.46

1.9

SCR-1

KYR

**SELECT**

33.5 mm.

SEL-11

SEL-1D

**PARA: FOR:**

**SELECT**

43.5 mm.

SEL-21

SEL-2D

SEL-3D

SEL-4D

**SELIVANOVSK**

SL-1

Copyright by  
Alejandro Altuna S.A.  
2005

**JMA**

**91**

ATENCION:Concerniente a las marcas y denominaciones comerciales ver nota en indice.ATTENTION:Concerning the marks and commercial denominations see note in index.  
ATTENTION:Concernant les marques et denominations commerciales voir la note dans l'index.ACHTUNG:Beziehen auf die marke und handelsname sehen sie die notiz im index.

**PARA-FOR:**

PARA:  
FOR:

SERRETA

SHANGAI

SHAW

SERRETA (E)

SHANGAI (RC)

SHAW (GB)

SHILUTE (RUS)

SIMECA (CH)

SIS (I)

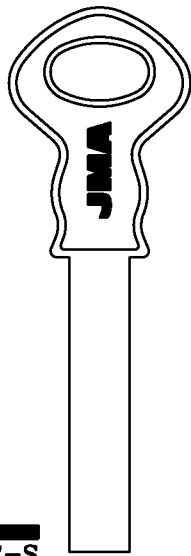

7-S

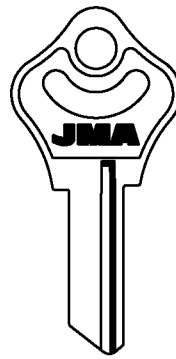

SHA-1

CINA

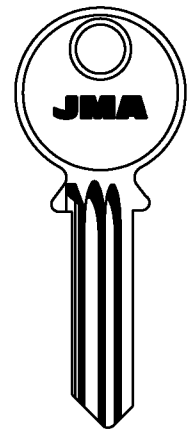

04  
SH-11

HTV-VAUGHN-YALE

PARA:  
FOR:

SHILUTE

SIMECA

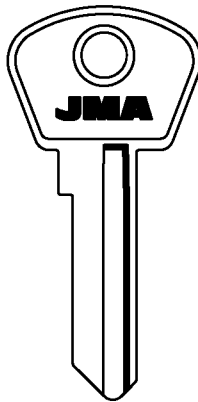

SHI-1

SHI-1D

SHI-2D

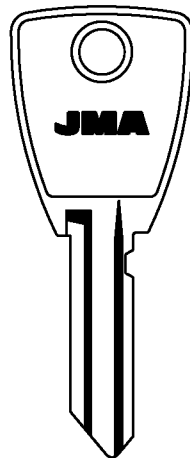

SM-1

GUTLER-KATE-ORBA  
SIAM-SIMATIC

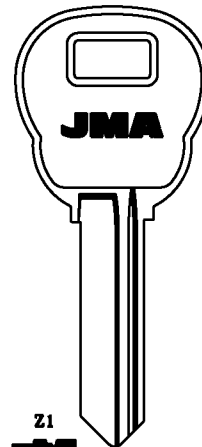

Z1  
SM-2

40

SM-3

GUTLER-KATE-ORBA  
SIAM-SIMATIC

SM-3D

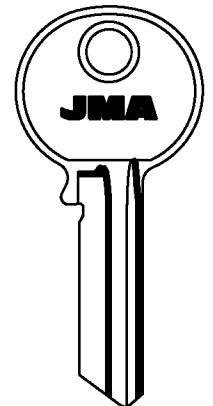

SM-4

SM-4D

PARA:  
FOR:

SIS

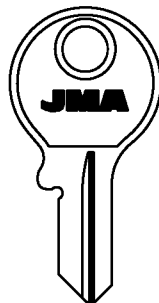

SIS-1

FEL

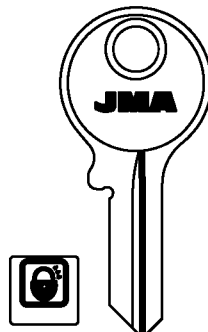

SIS-2

SIS-6

SIS-6D

SIS-7D

UTZ-ZENITH

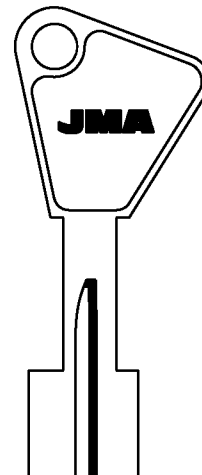

SIS-3

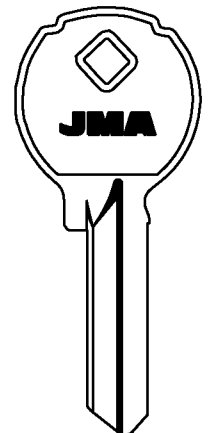

SIS-4D







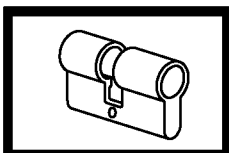

LÁSBOLAGET

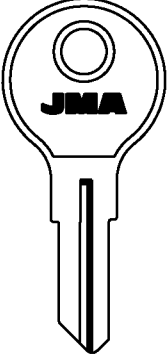
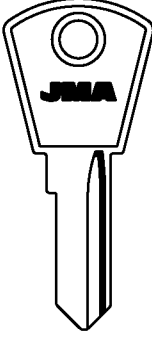
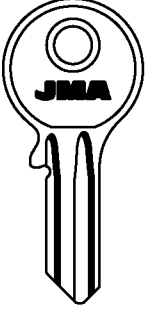
Copyright by  
Alejandro Altuna S.A.  
2005

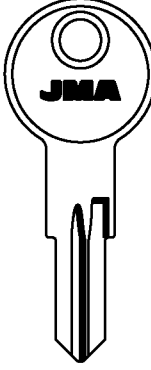
**JMA**











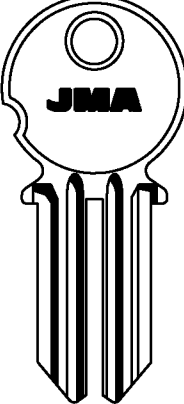
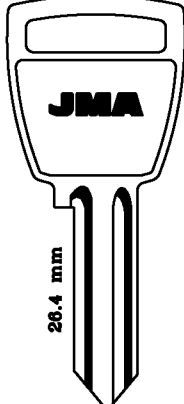
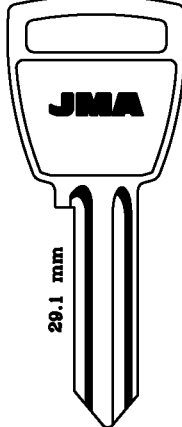



**92**

<b>PARA: FOR:</b>	<b>SIS</b>			<b>SISO</b>
				
				
SIS-5D	SIS-8	SIS-8D	SIS-9	SISO-1 SISO-2 EVERGOOD

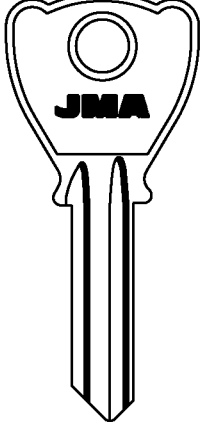
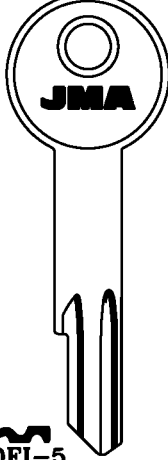
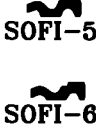
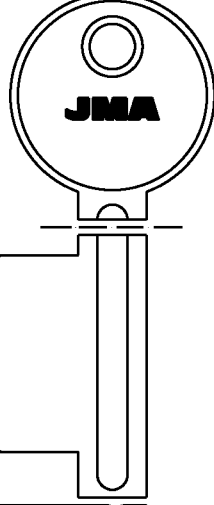
**PARA-FOR:**

**SIS (I)**  
**SISO (I)**  
**SJL (RUS)**  
**SOFER (P)**  
**SOFI SONAFI (P)**  
**SOLER (E)**

<b>PARA: FOR:</b>	<b>SJL</b>	<b>SOFER</b>	<b>SOFI SONAFI</b>	
				
				
SJL-1	SOFER-1 SOFER-2 SIL	28.4 mm SOFI-1I	29.1 mm SOFI-1D	SOFI-2I SOFI-2D

<b>PARA: FOR:</b>	<b>SOFI SONAFI</b>			<b>SOLER</b>
				
				
SOFI-3I	SOFI-4 SOFI-4D	SOFI-5	SOFI-6	90 mm SOL-1

Copyright by  
Alejandro Altuna S.A.  
2005

**JMA**

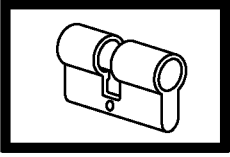

**93**

**PARA-FOR:**

**SOPRANO (BR)**





**SOS (F)**

**SPIDER (IL)**

**SQUIRE & S.  
(GB)**

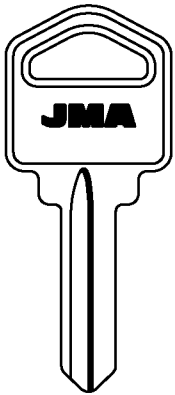
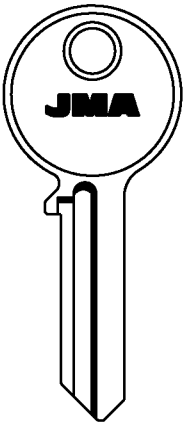
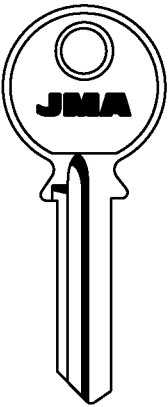
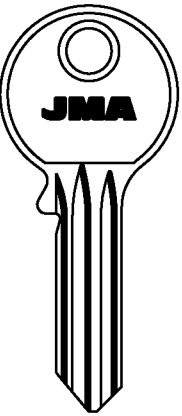
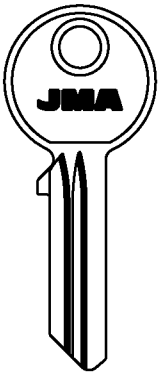
**STA LOCK (GB)**

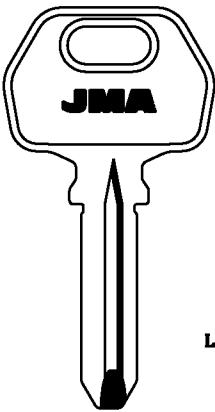
**STAR (J)**

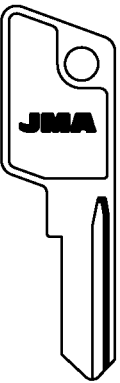
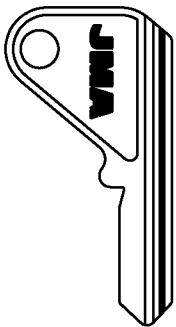
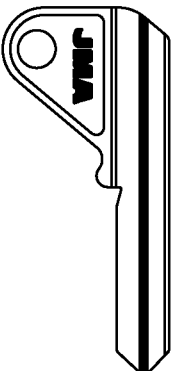
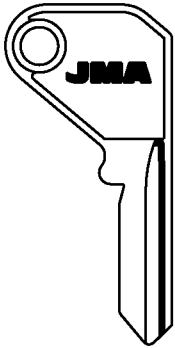
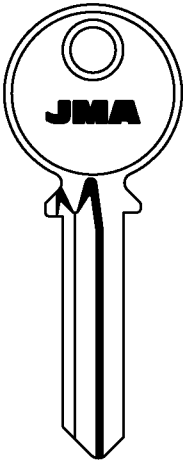
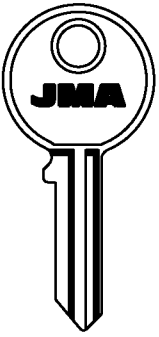
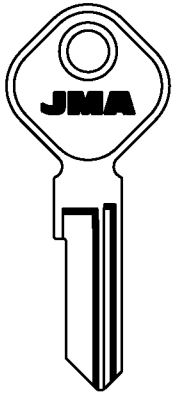
<p>PARA: SOPRANO FOR:</p>  <p>SOP-1D</p>	<p>SOS</p>     <p>SOS-1D    SOS-2D    SOS-3    SOS-4D</p>			
<p>PARA: SOS FOR:</p>   <p>SOS-5</p>	<p>SPIDER</p>  <p>LAT.</p>   <p>SPI-1    SPI-1D</p> <p>CAVERS-CODKEY-LOCKSYS</p>	<p>SQUIRE &amp; S.</p>    <p>SQ-1    SQ-2    SQ-3D</p>		
<p>PARA: SQUIRE &amp; FOR:</p>  <p>SQ-4</p>	<p>STA LOCK</p>   <p>STL-1D    STL-2I</p> <p>SECURE    SECURE</p>		<p>STAR</p>  <p>K.... 1-1600</p> <p>STA-1    STA-1D</p>	

Copyright by  
Alejandro Altuna S.A.  
2005

**JMA**

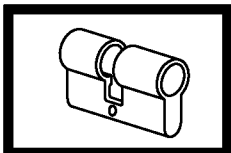

PARA:  
FOR:

### STAR

**PARA-FOR:**

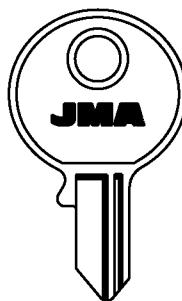
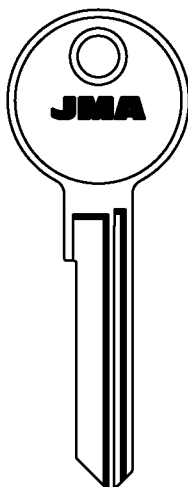
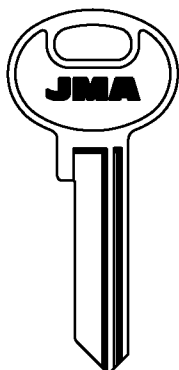
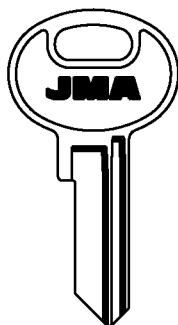

STAR (J)

STARLET (D)

STEKLOMASH  
(RUS)

STREBOR (GB)

STS (E)

PARA:  
FOR:

### STARLET

### STEKLOMASH

### STREBOR

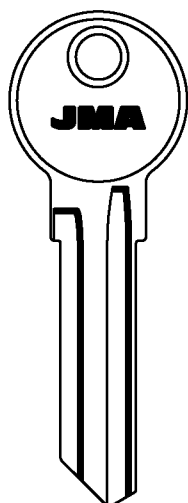
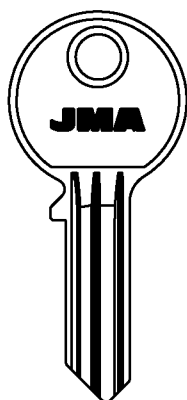
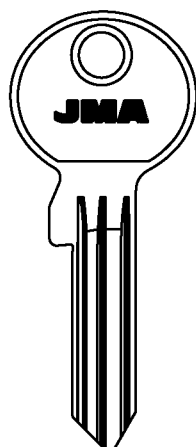

PARA:  
FOR:

### STREBOR

### STS

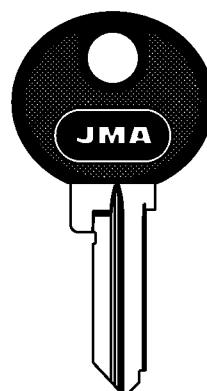
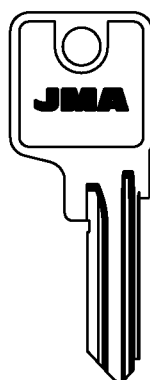
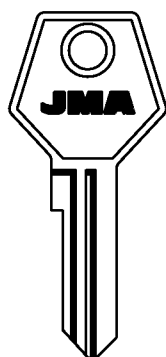
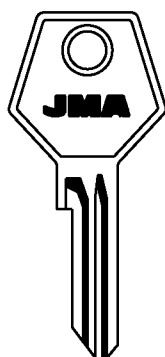

TS...300-369



S..1-70



ALU.  
LAT.



Copyright by  
Alejandro Altuna S.A.  
2005

# JMA

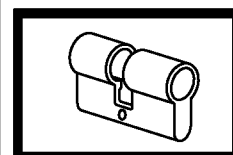

## 95

**PARA-FOR:**

PARA:  
FOR:

**STS**

**STS (E)**



STS-3I STS-3D

SEMEL

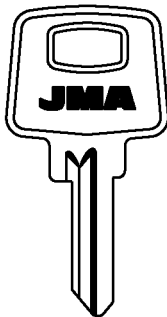

STS-4D

BTV

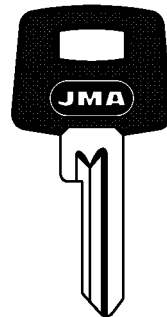

STS-4D.P

BTV

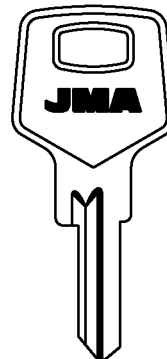

STS-6D

BTV

PARA:  
FOR:

**STS**

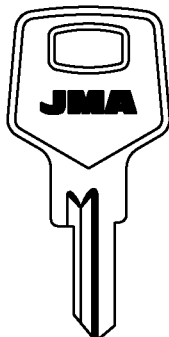

STS-7D

BTV

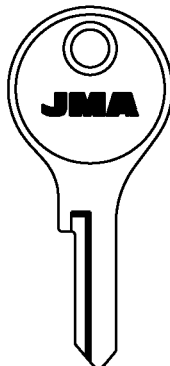

STS-12D

DAD

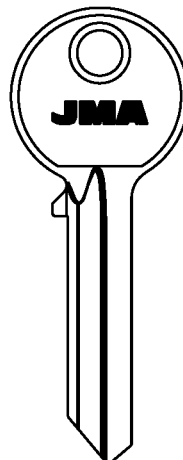

STS-21D

ALP.

LAT.

9 2.5 MEGA6  
STS-35 STS-38

PARA:  
FOR:

**STS**

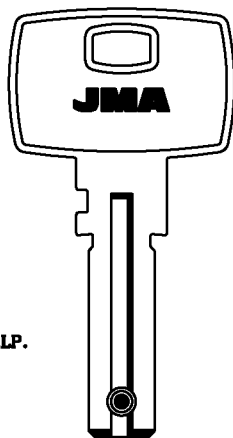

ALP.

IX-BOLA  
8.5 2.3  
STS-B1

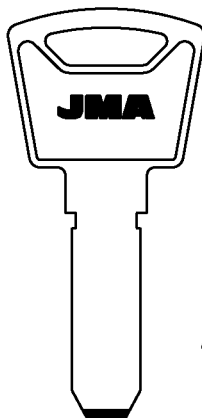

8.8 2.3  
STS-T14

CAYS

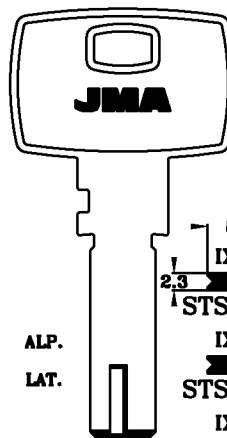

ALP.

ALP.

LAT.

8.5 2.3 IX-3  
STS-TV3  
IX-5  
STS-TV5  
IX-8  
STS-TV8  
IX-9  
STS-TV9  
DOM-ESAFE  
FAC-IFAM  
SERRALLER  
TECSESA  
TECNOLAR

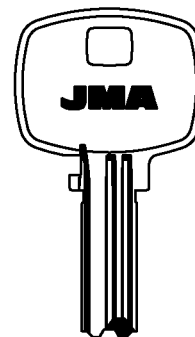

LAT.





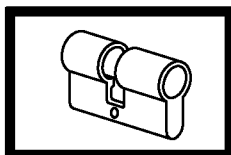

7.1 2.3  
STS-X5



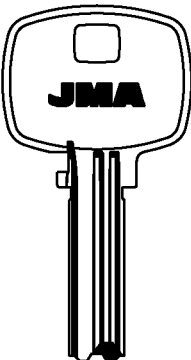

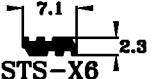

Copyright by  
Alejandro Altuna S.A.  
2005

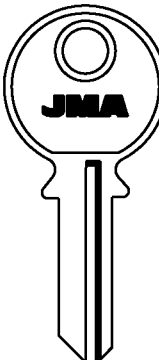

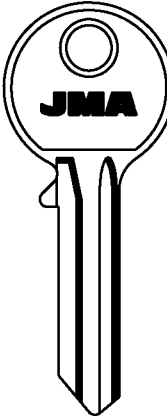
**JMA**

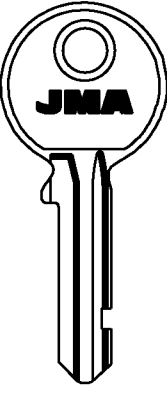

**96**

<b>PARA: FOR:</b>	<b>STS</b>	<b>STUMPF</b>	<b>STUV</b>		<b>PARA-FOR:</b>
	 <p>LAT.</p>   <p>STS-X6</p>	 <p>STF-1    STF-1D</p>	  <p>1F...201-278    2F... 1F...Z201-278    201-278 1F...X201-278</p> <p>STUV-1I    STUV-1D</p> <p>DOM-MLM</p>	 <p>STUV-2</p>	<p><b>STS (E)</b></p> <p><b>STUMPF (D)</b></p> <p><b>STUV (D)</b></p> <p><b>SUREX (F)</b></p> <p><b>TAITO (J)</b></p> <p><b>TALLINN (RUS)</b></p>

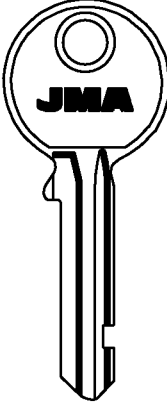
<b>PARA: FOR:</b>	<b>SUREX</b>			
	  <p>SR-1I</p>	  <p>SR-2</p> <p>ATLAS</p>	  <p>SR-3</p> <p>ATLAS-EUROP-MATTEY</p>	  <p>SR-4</p>

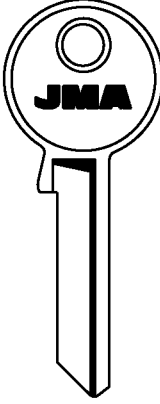
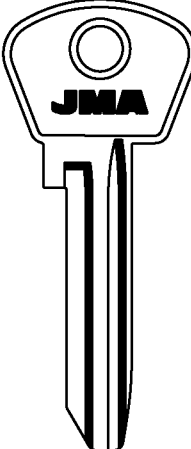
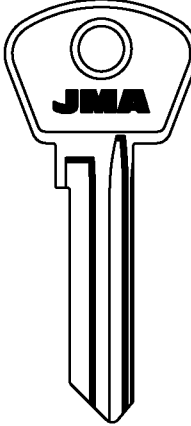
<b>PARA: FOR:</b>	<b>SUREX</b>	<b>TAITO</b>	<b>TALLINN</b>	
	  <p>SR-5</p>	 <p>TAI-1</p>	 <p>TAL-1    TAL-1D</p>	 <p>TAL-2</p>





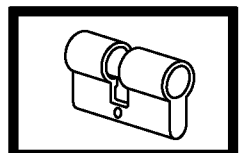

Copyright by  
Alejandro Altuna S.A.  
2005



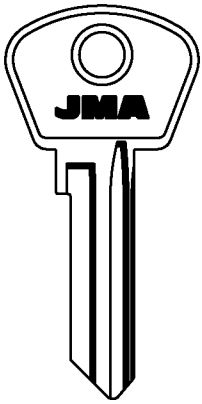

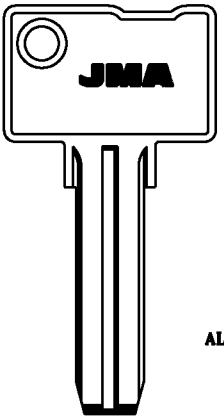
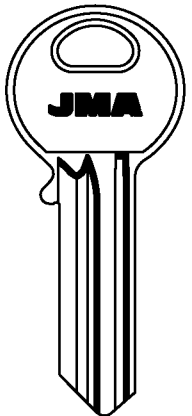

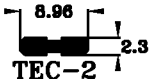

**JMA**

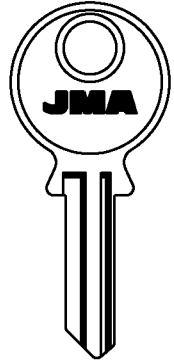
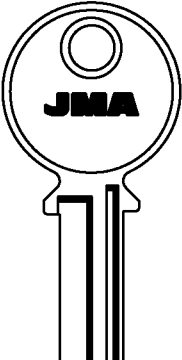
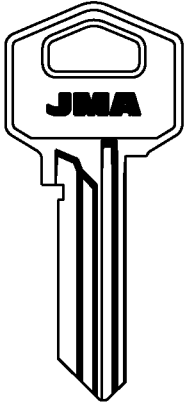
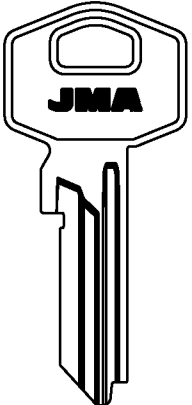







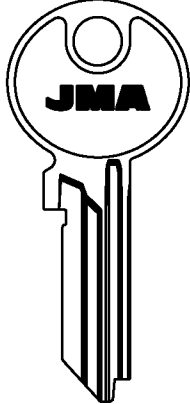
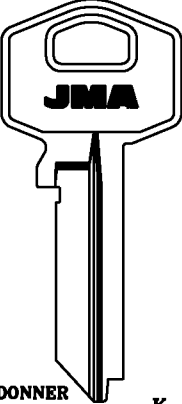
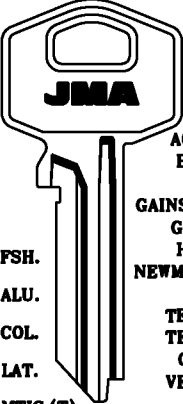
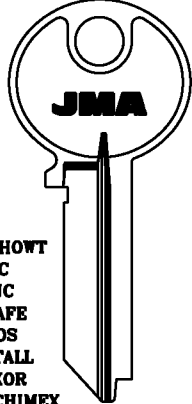

**PARA-FOR:**

- TALLINN (RUS)**
- TAYLOR (USA)**
- TECSESA (E)**
- TEKA (S)**
- TEM (E)**
- TESA (E)**

<b>PARA:</b> <b>FOR:</b>	<b>TALLINN</b>	<b>TAYLOR</b>	<b>TECSESA</b>	<b>TEKA</b>
			 ALP.	
	 TAL-3	 TAY-1	 TEC-2	 20104 TK-2I    20004 TK-2D ASSA-ERMEX-LM

<b>PARA:</b> <b>FOR:</b>	<b>TEM</b>		<b>TESA</b>	
				
	 TEM-I35	 TEM-D35	 TE-11	 TE-1D
	 TEM-I55	 TEM-D55 CORSA	 TE-3	MR

<b>PARA:</b> <b>FOR:</b>	<b>TESA</b>			
				
	 TE-4 IFOS	 TE-7D	 TE-81	 TE-9D
		<p>DONNER K</p> <p>ESCO .....</p> <p>FORTRESS 0 AL 9</p> <p>GAINSBOROUGH .....</p> <p>HARLOC A/Z 1 AL 9</p> <p>KAWE</p> <p>MASTERCRAFT</p> <p>TAYMOR</p>	<p>AGUEDA</p> <p>BENCO</p> <p>KAWE</p> <p>GAINSBOROUGH</p> <p>GELBAU</p> <p>HERPE</p> <p>NEWMAN TONKS</p> <p>SE</p> <p>TECHNAL</p> <p>TEICOCIL</p> <p>ORION</p> <p>VENLOCK</p> <p>• FSH.</p> <p>• ALU.</p> <p>• COL.</p> <p>• LAT.</p> <p>• MTIC.(T)</p> <p>T.....</p> <p>0 AL 9</p> <p> TE-8D</p> <p> TE-8DKT1</p>	<p>BURGHOWT</p> <p>CC</p> <p>DJC</p> <p>ESAFE</p> <p>IFOS</p> <p>INSTALL</p> <p>LUXOR</p> <p>METALCHIMEX</p> <p>METALUX</p> <p>SES</p> <p>SOS</p> <p> TE-10I</p>

Copyright by  
Alejandro Altuna S.A.  
2005

**JMA**

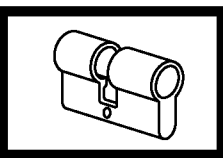

**98**

ATENCION:Concerniente a las marcas y denominaciones comerciales ver nota en indice.ATTENTION:Concerning the marks and commercial denominations see note in index. ATTENTION:Concernant les marques et denominations commerciales voir la note dans l'index.ACHTUNG:Beziehen auf die marke und handelsname sehen sie die notiz im index.

PARA:  
FOR:

# TESA

PARA-FOR:

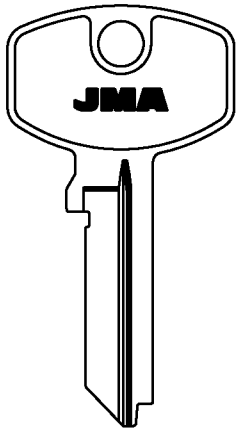

TE-11D

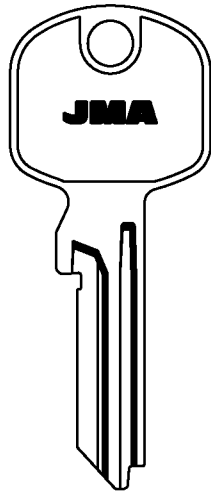

TE-23

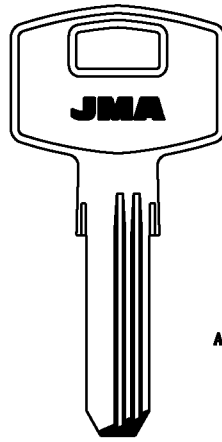

TE-T10

ALP.

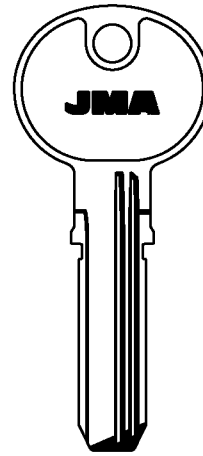

TE-T60

LAT.

CORNI-ELCA-ESAFE-FAC-STS

THOMAS LAIDLAW

TESA (E)

TH (D)

TICINO (I)

TIFON (RC)

TITAN (YU)

PARA:  
FOR:

# TESA

# TH

# TICINO

# TIFON

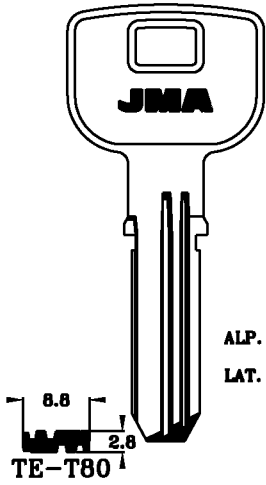

TE-T80

ALP.  
LAT.

SC  
TE-T80SC

ESAFE-STS-YEMAR

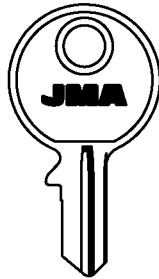

TH-1

TRUMPH



TI-1

TI-1D

BERTOLOTTI



TIF-1D



PARA:  
FOR:

# TITAN

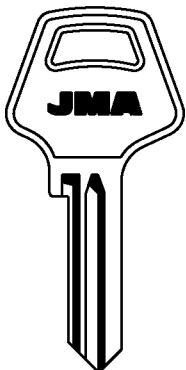

TIT-1D

HILLMANN-PAYKAN

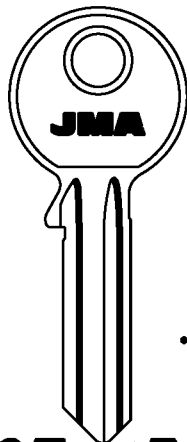

TIT-2

• ALU.

• TIT-2D

TIT-10

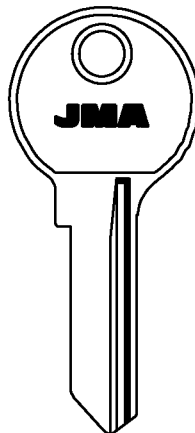

TIT-3

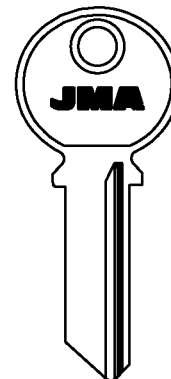

TIT-4

FTH-VACHETTE

Copyright by  
Alejandro Altuna S.A.  
2005

# JMA

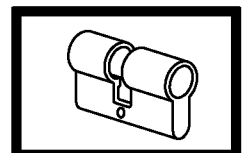

# 99

**PARA-FOR:**

**TITAN (YU)**

**TOK WINKHAUS (D)**

**PARA: FOR:** **TITAN**

TIT-5      TIT-6      TIT-8D      TIT-9D

LAT.      ALU.      LAMA

8.95  
2.8

**PARA: FOR:** **TITAN**

...251-300  
TIT-11D

TIT-12D      TIT-13

PICARDIE

**TOK WINKHAUS**

TOK-2      TOK-2D      TOK-3      TOK-3D

TRELOCK      TRELOCK

**PARA: FOR:** **TOK WINKHAUS**

COL.

N/T/9....  
.....  
0 AL 8

P....  
0 AL 8

TOK-4D      TOK-5D      TOK-6      TOK-6D      TOK-25      TOK-26      TOK-27

TRELOCK      COMBA-SIEBAU TRELOCK-VACHETTE

N....  
T....  
9....  
.....9  
0 AL 8

Copyright by Alejandro Altuna S.A. 2005

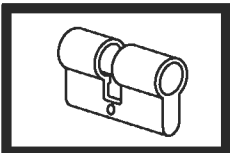

**100**

ATENCION:Concerniente a las marcas y denominaciones comerciales ver nota en indice.ATTENTION:Concerning the marks and commercial denominations see note in Index. ATTENTION:Concernant les marques et denominations commerciales voir la note dans l'Index.ACHTUNG:Beziehen auf die marke und handelsname sehen sie die notiz im Index.

PARA:  
FOR:

### TOK WINKHAUS

PARA-FOR:

TOK WINKHAUS  
(D)

TOMSK (RUS)

TOP (D)

TOVER (E)

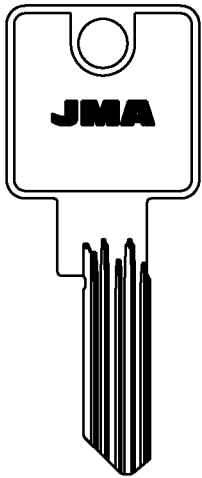

EAFP  
TOK-23

TOK-15

TOK-13D

TOK-11

TOK-9

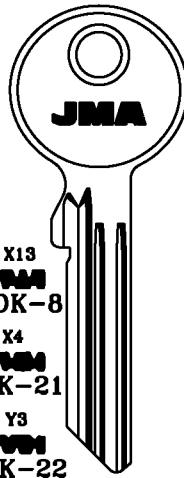

TOK-28D

TOK-16D

TOK-14D

TOK-12

TOK-10D

X13  
TOK-8

X4  
TOK-21

Y3  
TOK-22

Y14  
TOK-24

LAT.

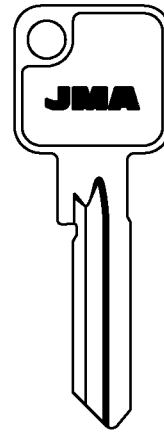

TOK-17D

BFA3  
BIF-1

ENAX  
TOK-7D

EFAM  
EFWS  
TOK-11

EWSB  
TOK-12

FICHET-BIFFAR

TRELOCK

PARA:  
FOR:

### TOK WINKHAUS

### TOMSK

### TOP

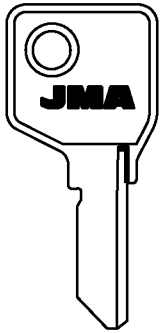

TOK-18

TOK-19

TOK-20

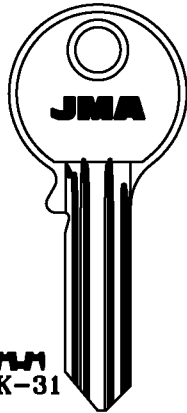

TOK-31

TOK-30

TOK-29D

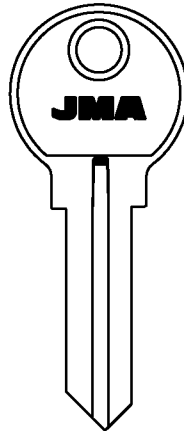

TOM-1D

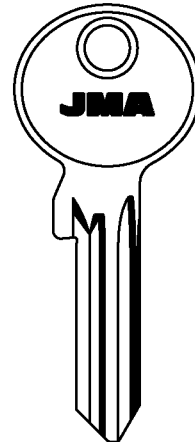

TOP-1

ABUS-NOVA

PARA:  
FOR:

### TOVER

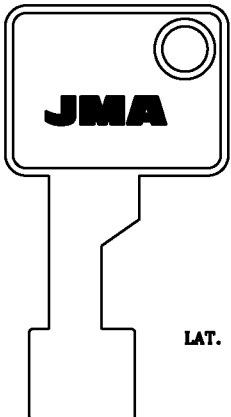

LAT.

TOV-1

TEICOCIL

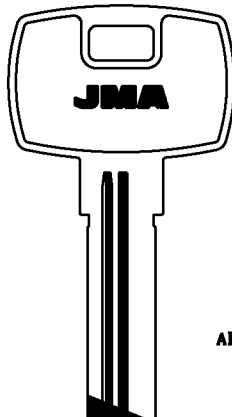

ALP.

TOV-2

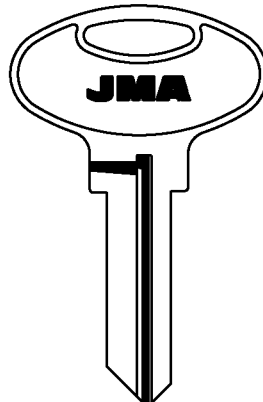

TOV-3

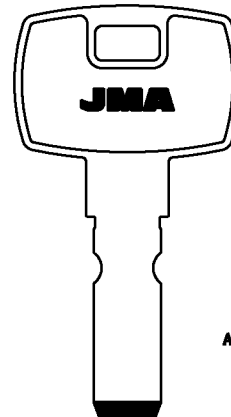

ALP.

TOV-4

TROMER

Copyright by  
Alejandro Altuna S.A.  
2005

JMA

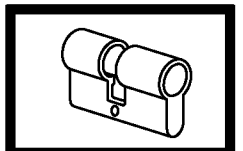

101





**PARA-FOR:**





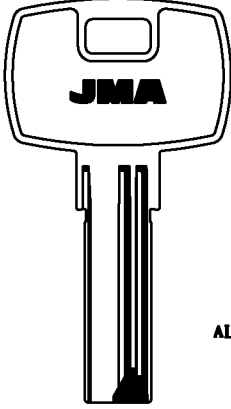
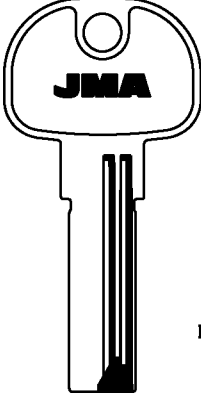

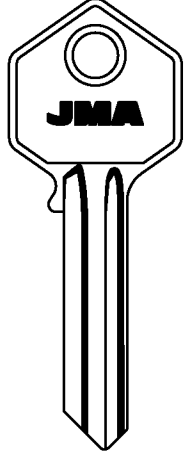
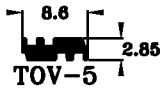
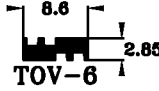
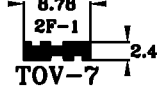



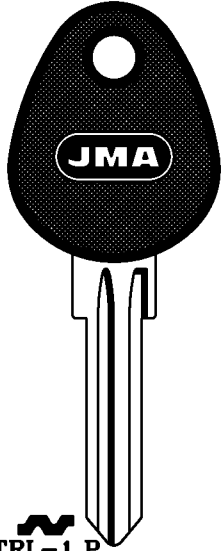

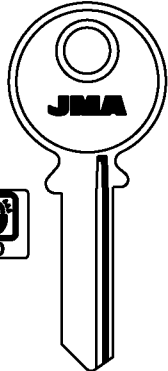



**TOVER (E)**











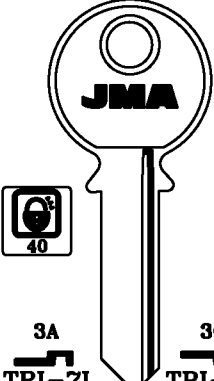
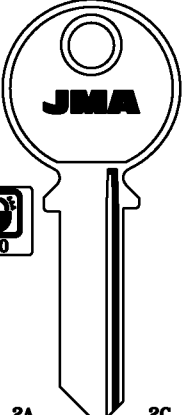
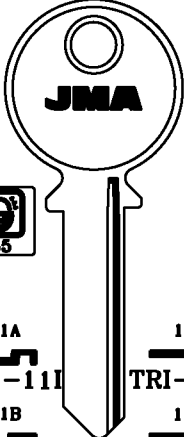

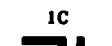

**TRAVEX (PE)**

**TRELOCK (D)**

**TRI-CIRCLE (RC)**

<b>PARA: FOR:</b>	<b>TOVER</b>			<b>TRAVEX</b>	
					
	ALP.	LAT.	LAT.		
					

<b>PARA: FOR:</b>	<b>TRELOCK</b>	<b>TRI-CIRCLE</b>			
					
					
					
					
					
				<b>MARK</b>	<b>ELEPHANT</b>

<b>PARA: FOR:</b>	<b>TRI-CIRCLE</b>			
				
				
				
				
				

Copyright by  
Alejandro Altuna S.A.  
2005

**JMA**

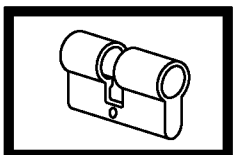

**102**

PARA:  
FOR:

### TRI-CIRCLE

PARA-FOR:

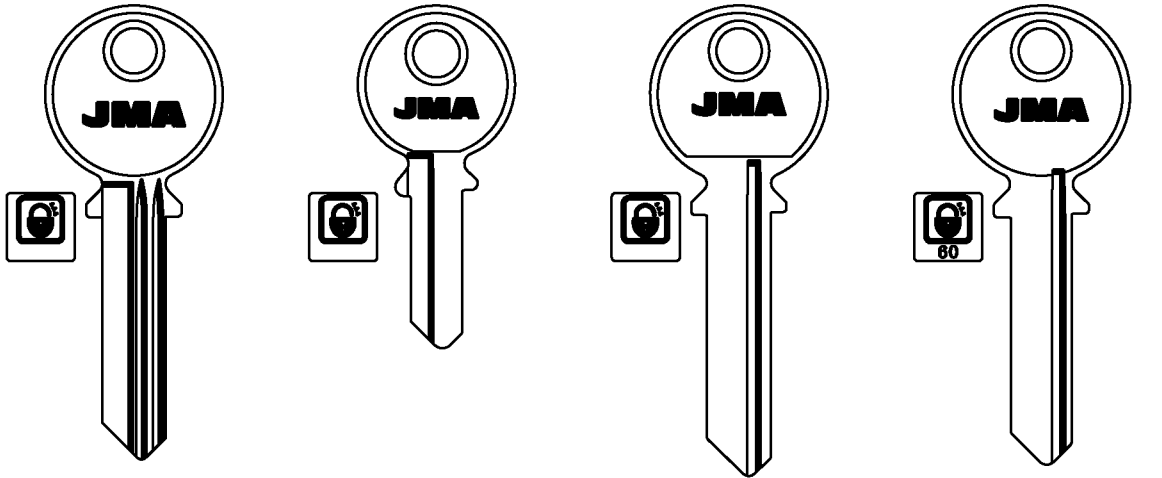

TRI-16

TRI-17D

TRI-18 TRI-18D

TRI-19 TRI-19D

TRI-CIRCLE  
(RC)

TRI-STAR  
(RC)

TRIO-VING  
(N)

PARA: TRI-CIRCLE  
FOR:

### TRI-STAR

### TRIO-VING

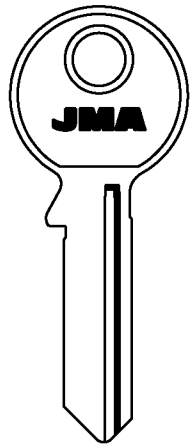

TRI-20

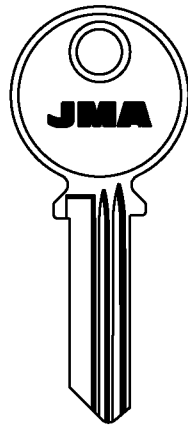

TST-1

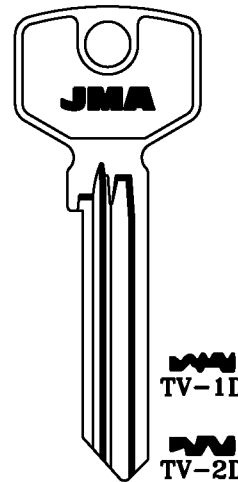

TV-1D  
TV-2D

TV-13

PARA:  
FOR:

### TRIO-VING

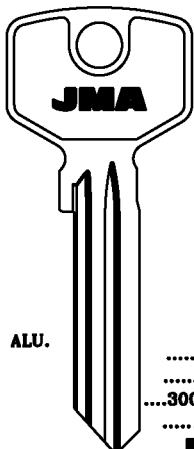

ALU.

.....1 AL 9  
.....0 AL 9  
.....30000-56769  
.....1-26770

TV-3D

TV-4D

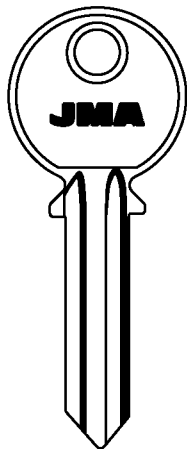

ALU.

TV-11

TRIO

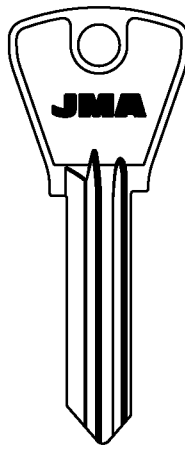

ALU.

.....  
0 AL 9  
TV-12

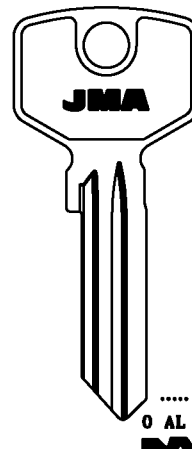

.....  
0 AL 9  
TV-15D

TV-16D

Copyright by  
Alejandro Altuna S.A.  
2005

# JMA

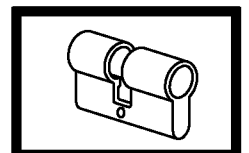

**PARA-FOR:**

**TRIO-VING (N)**











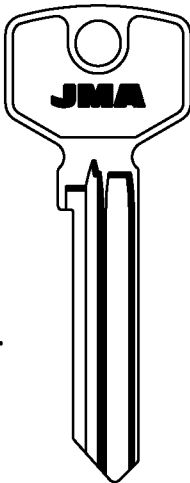



**TSAG (E)**





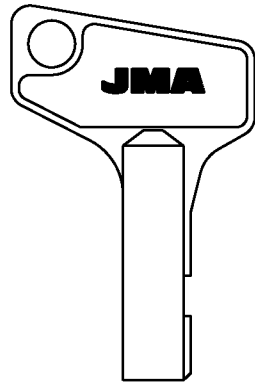

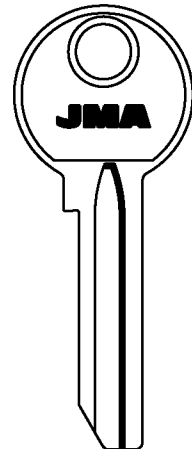

**TULA (RUS)**

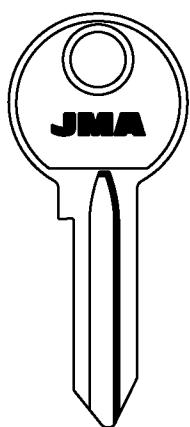

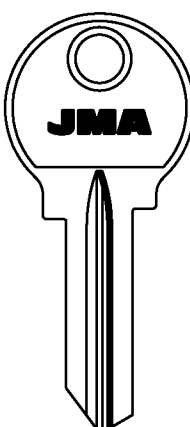

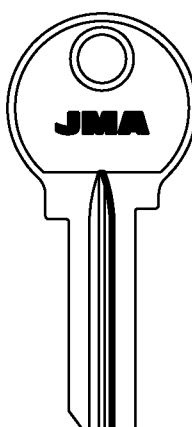

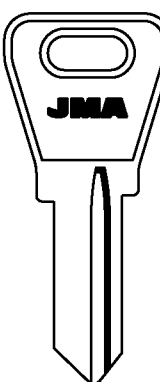

**TUSHINO (RUS)**

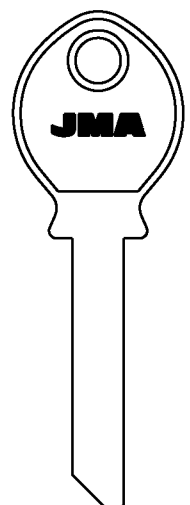
**TZAFRER (GR)**

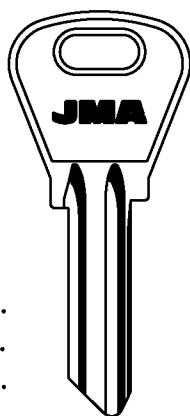
**UCEM (E)**

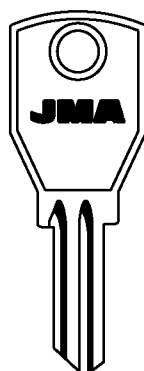
<b>PARA:</b>	<b>TRIO-VING</b>	<b>TSAG</b>	<b>TULA</b>
<b>FOR:</b>	 <p>LAT.</p>  TV-17  TV-17D  TV-18D  TV-19D  TV-20  TV-21  TV-22  TV-22D  TV-23  TV-23D	  SAG-1T	  TUL-1D

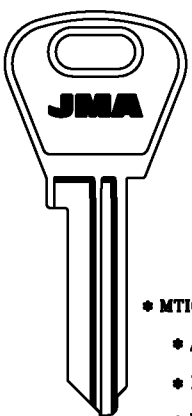
<b>PARA:</b>	<b>TULA</b>	<b>TUSHINO</b>		<b>TZAFRER</b>
<b>FOR:</b>	  TUL-2D	  TUS-1D	  TUS-2D	  TZ-1  TZ-1D

<b>PARA:</b>	<b>UCEM</b>			
<b>FOR:</b>	  5-L	<ul style="list-style-type: none"> <li>• ALU.</li> <li>• LAT.</li> <li>• FSH.</li> </ul>   UCEM-1I  UCEM-1D	  UCEM-2I  UCEM-2D	<ul style="list-style-type: none"> <li>• MTIC.(V)</li> <li>• ALU.</li> <li>• LAT.</li> <li>• FSH.</li> </ul>   UCEM-3  UCEM-12
		CIB-ENA.OQ-QCM-RIV		CIB-ND

Copyright by  
Alejandro Altuna S.A.  
2005

**JMA**

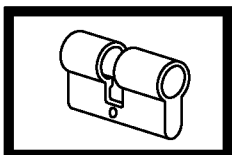

**104**

PARA:  
FOR:

### UCEM

**PARA-FOR:**

**UCEM (E)**

**ULIANOVSK  
(RUS)**

**UMF (P)**

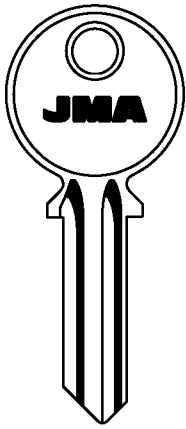

UCEM-4I

STIQAM

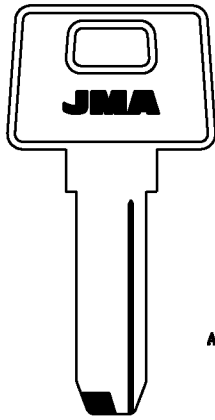

UCEM-5I UCEM-5D

PENT

ALP.

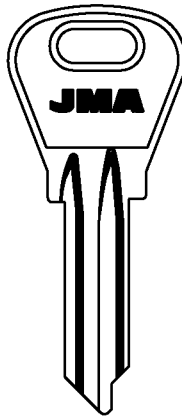

UCEM-7I UCEM-7D

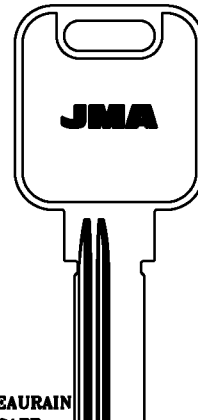

DEBEAURAIN  
ESAFE  
ISEO  
ND  
YEMAR

UCEM-8D

LAT.

PARA:  
FOR:

### UCEM

### ULIANOVSK

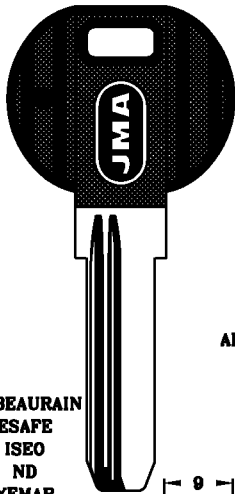

UCEM-8D.P

ALP.

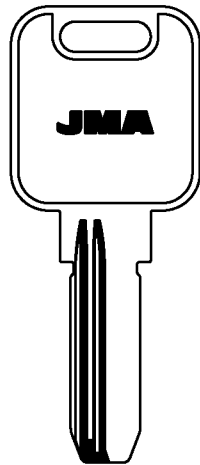

UCEM-13D

ALP.

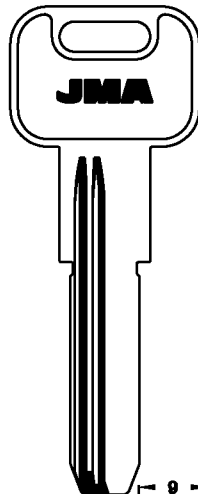

UCEM-17D

LAT.

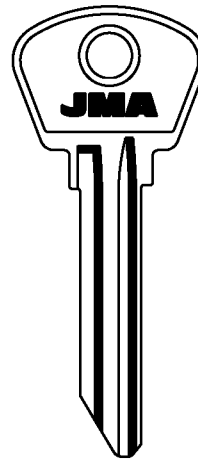

UL-1

DEBEAURAIN  
ESAFE  
ISEO  
ND  
YEMAR

PH

PARA:  
FOR:

### ULIANOVSK

### UMF

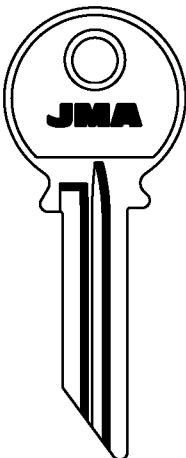

UL-2D

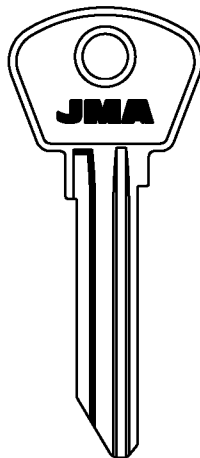

UL-3

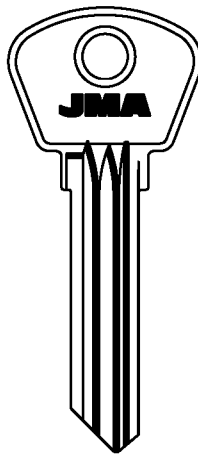

UL-4

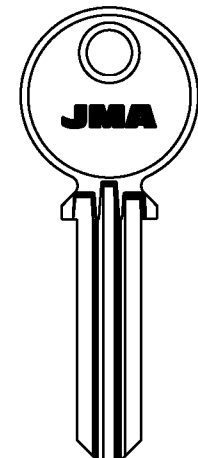

UMF-1

Copyright by  
Alejandro Altuna S.A.  
2005

# JMA

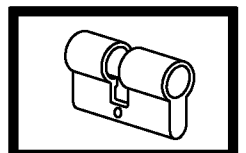



**PARA-FOR:**

**UNION (GB)**

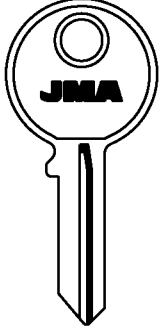
**PARA:** UNION  
**FOR:**



NRA  
FFE...1-100  
FJA...1-100  
FL...251-500  
NRA...51-90  
YFB...1-75  
FMD...1-75  
FG...1-30  
NF...1-30  
EJR...1-75

FP...  
626-750

UN-FFE UN-3 UN-FP

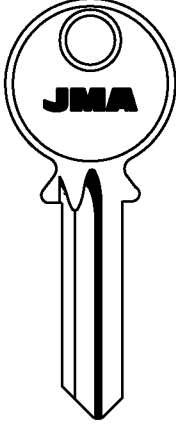
MC...1-40  
MRA...251-290  
MRN...1-54  
MRN...201-250  
MRN...251-300

HX...100

FR...  
751-875

UN-MRN UN-2 UN-FR

FS...1-99  
FS...878-955

FA...  
501-825

RM...  
911-952

NGN...1-54

UN-1FS UN-44 UN-44D UN-NG

KB53A  
UN-5D

KB506  
UN-6D

**PARA:** UNION  
**FOR:**

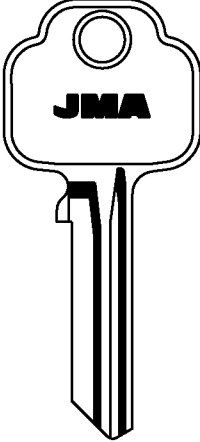

503  
UN-12I

574  
UN-13I

575  
UN-14I

578  
UN-15I

577  
UN-16I

578  
UN-17I

579  
UN-18I

UN-7I

581  
UN-19I

582  
UN-20I

583  
UN-21I

584  
UN-22I

585  
UN-23I

588  
UN-24I

587  
UN-25I

588  
UN-26I

589  
UN-27I

914  
UN-13D

915  
UN-14D

916  
UN-15D

917  
UN-16D

918  
UN-17D

919  
UN-18D

UN-7D

901  
UN-19D

902  
UN-20D

903  
UN-21D

904  
UN-22D

905  
UN-23D

908  
UN-24D

907  
UN-25D

908  
UN-26D

909  
UN-27D

**PARA:** UNION  
**FOR:**

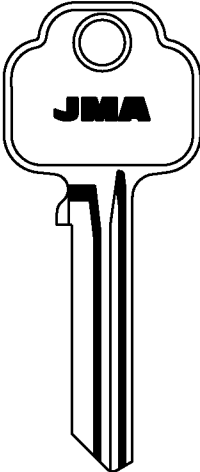

503  
UN-28I

574  
UN-29I

575  
UN-30I

578  
UN-31I

577  
UN-32I

578  
UN-33I

579  
UN-34I

UN-8I

581  
UN-35I

582  
UN-36I

583  
UN-37I

584  
UN-38I

585  
UN-39I

588  
UN-40I

587  
UN-41I

588  
UN-42I

589  
UN-43I

914  
UN-29D

915  
UN-30D

916  
UN-31D

917  
UN-32D

918  
UN-33D

919  
UN-34D

UN-8D

901  
UN-35D

902  
UN-36D

903  
UN-37D

904  
UN-38D

905  
UN-39D

908  
UN-40D

907  
UN-41D

908  
UN-42D

909  
UN-43D

Copyright by  
Alejandro Altuna S.A.  
2005

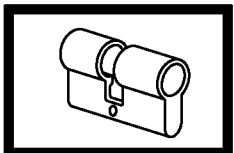

PARA:  
FOR:

### UNION

PARA-FOR:

UNION (GB)

UNIVERSAL

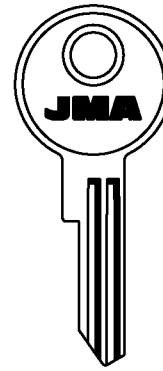
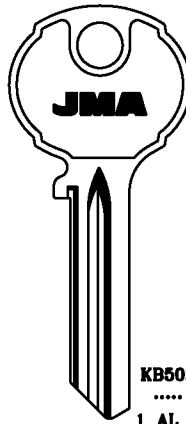
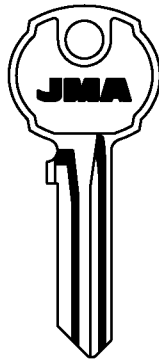

KB502  
.....  
1 AL 6  
  
UN-11

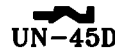
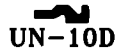



UNION

PARA:  
FOR:

### UNION

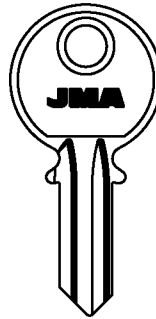
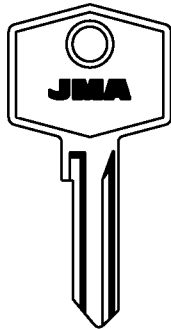
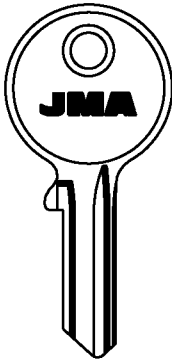
### UNIVERSAL



TBS...1-50  
NKL...1-150  
NND...1-150  
TBS...1-500  
TBS...201-350  
  
UN-47

FK...  
01-99  
878-955  
  
UN-FK

FS...  
01-99  
878-955  
  
UN-FS



TECNO

PARA:  
FOR:

### UNIVERSAL

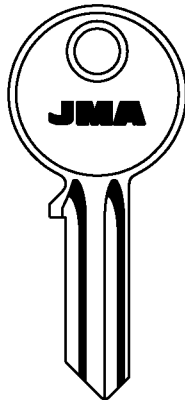
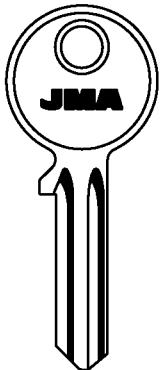

ALU.

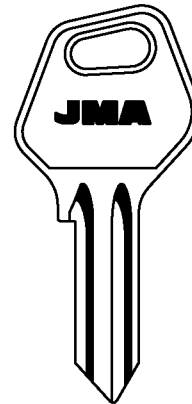
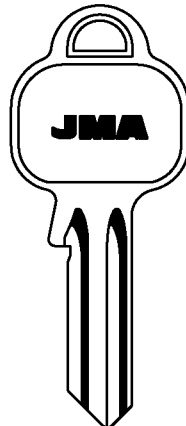

Copyright by  
Alejandro Altuna S.A.  
2005

# JMA

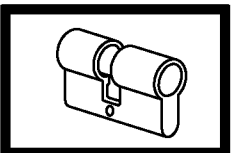

**PARA-FOR:**

**PARA:  
FOR:**

**UNIVERSAL**

**UNIVERSAL**

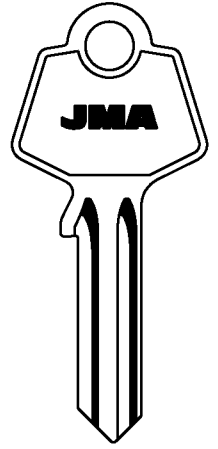
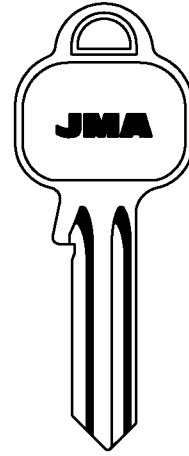
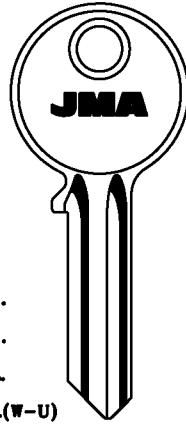
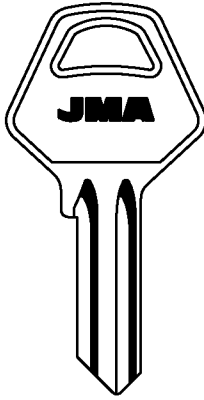

ALU.  
• FSH.  
COL.  
MTIC.(W-U)

U-4TI

U-4TD

U-5I

• U-5D

U-5AI

U-5AD

U-5CI

U-5CD

ESAFE-SIL

**PARA:  
FOR:**

**UNIVERSAL**

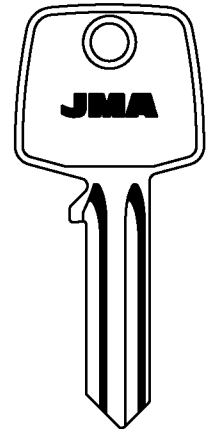
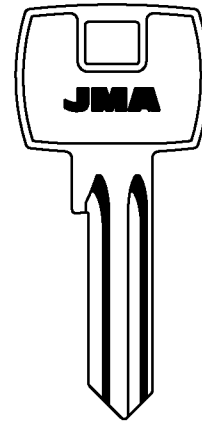
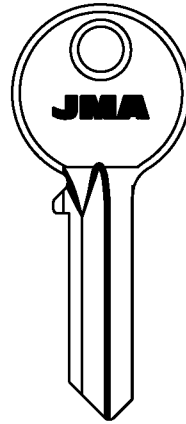

U-5DI

U-5DD

U-5DSP

U-5EI

U-5ED

U-5FI

U-5FD

**PARA:  
FOR:**

**UNIVERSAL**

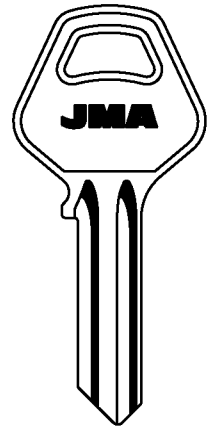
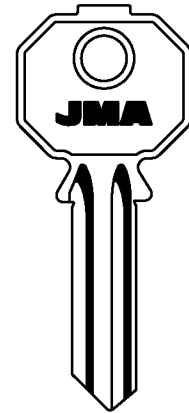
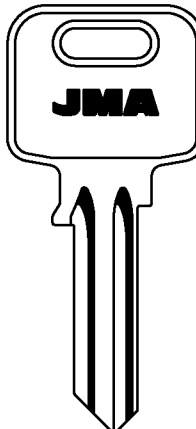
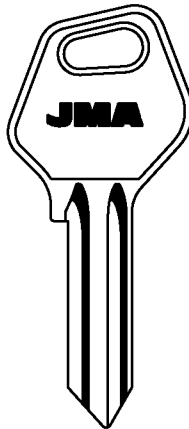

U-5JI

U-5JD

U-5MI

U-5MD

U-5PI

U-5PD

U-5TI

U-5TD

Copyright by  
Alejandro Altuna S.A.  
2005

**JMA**

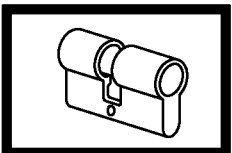

**108**

ATENCION:Concerniente a las marcas y denominaciones comerciales ver nota en indice.ATTENTION:Concerning the marks and commercial denominations see note in index.  
ATTENTION:Concernant les marques et denominations commerciales voir la note dans l'index.ACHTUNG:Beziehen auf die marke und handelsname sehen sie die notiz im index.

PARA:  
FOR:

UNIVERSAL

PARA-FOR:

UNIVERSAL

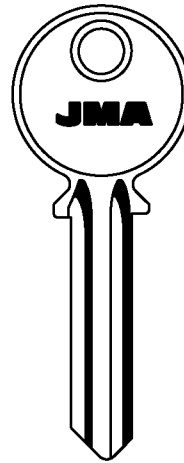
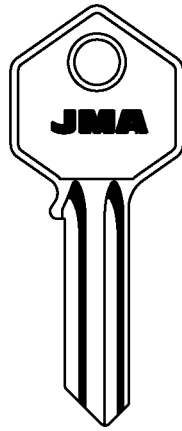
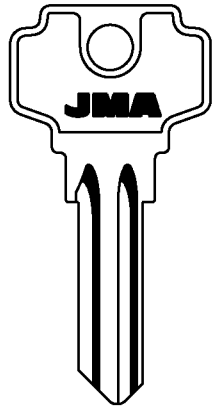
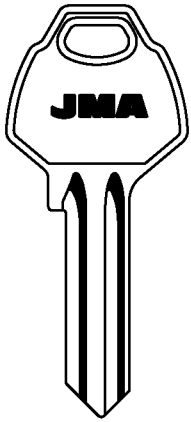

COL.  
ALU.

U-5VI

U-5VD

U-5XI

U-5XD

U-5YI

U-5YD

U-6I

U-6D

PARA:  
FOR:

UNIVERSAL

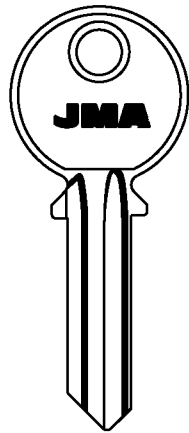
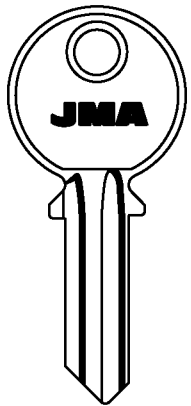

LAT.

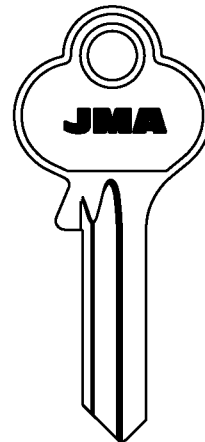
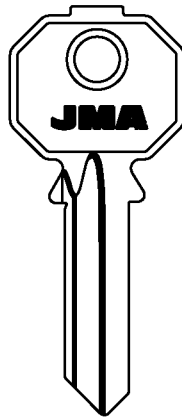

U-7

U-7D

U-8

U-8D

U-8PD

U-8TD

TVO-1D

PARA:  
FOR:

UNIVERSAL

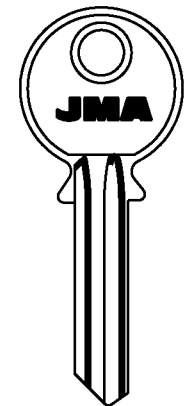
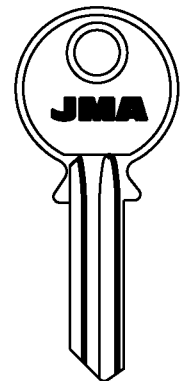
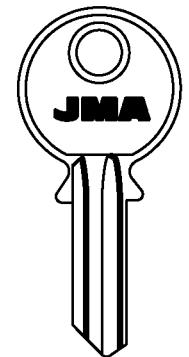
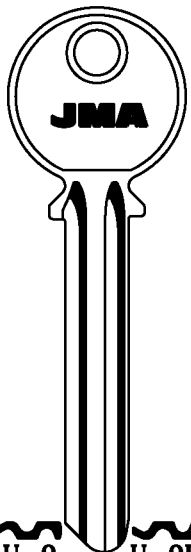

U-9

U-9D

U-10I

U-10D

U-13I

U-13D

U-14I

U-14D

TVO-3D

TVO-2D

Copyright by  
Alejandro Altuna S.A.  
2005

JMA

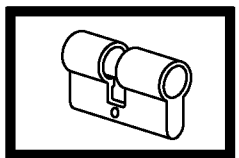









**PARA-FOR:**

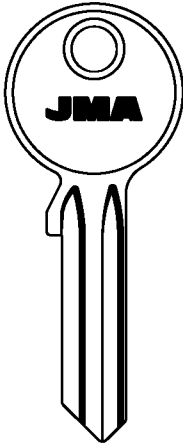

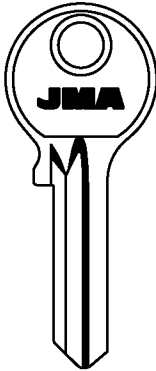
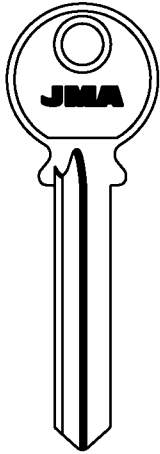

**UNIVERSAL**





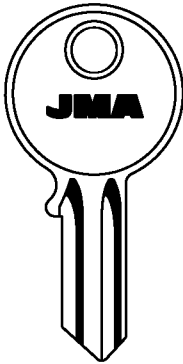
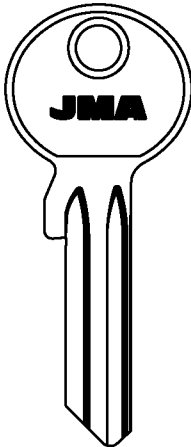
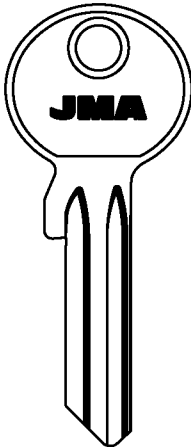
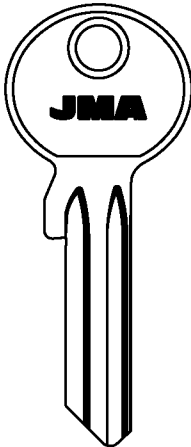

**URBIS (R)**



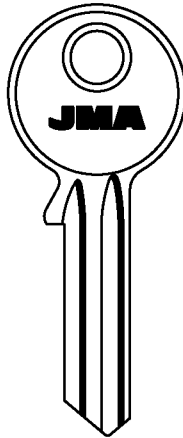





**URKO (E)**

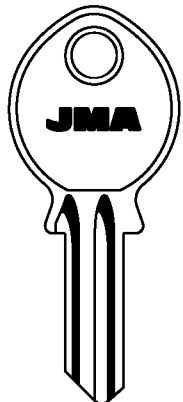

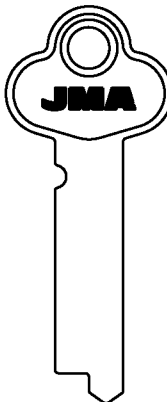
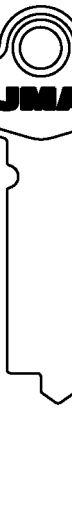
**VACHETTE (E)**

PARA: FOR:		UNIVERSAL					
							
							
		TV0-4D					

PARA: FOR:		UNIVERSAL			
					
					

PARA: FOR:		URBIS		
				
				

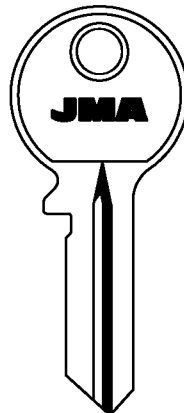
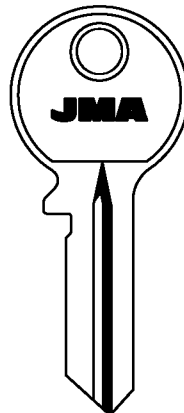
PARA: FOR:		URKO			
					
					
					

PARA: FOR:		VACHETTE	
			
			
		A1....5001-5631	
		BAU-FONTAINE-HEMA-LAPERCHE METALUX-MODERN-STREMLER	

Copyright by  
Alejandro Altuna S.A.  
2005

**JMA**

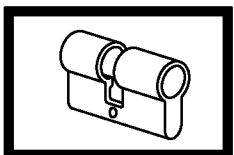

**110**

PARA:  
FOR:

### VACHETTE

PARA-FOR:

VACHETTE (F)

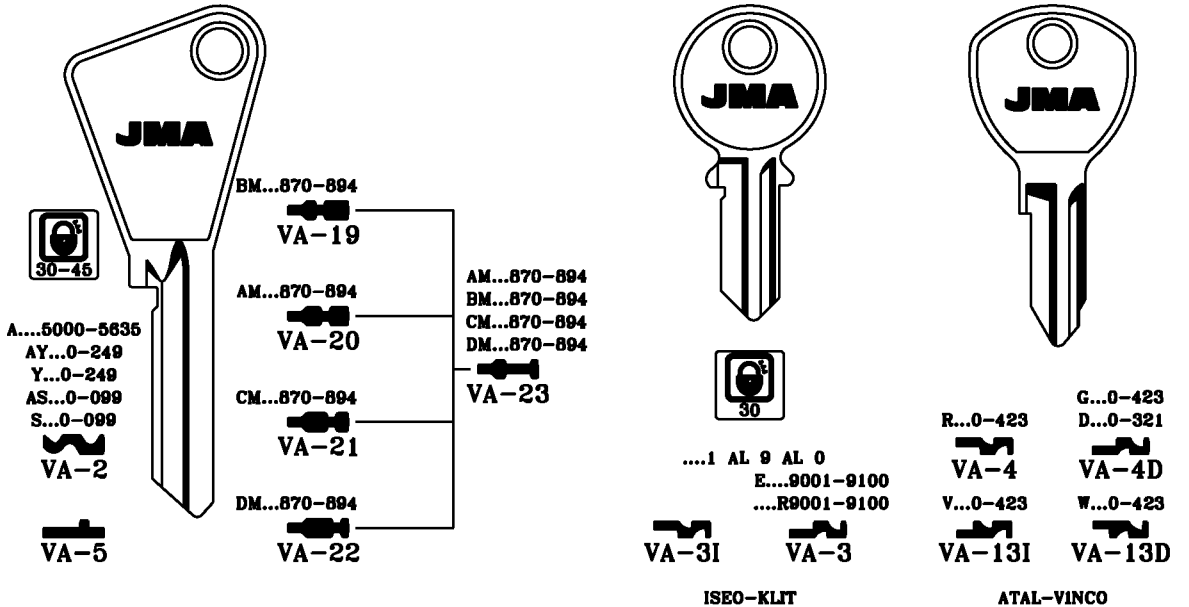

PARA:  
FOR:

### VACHETTE

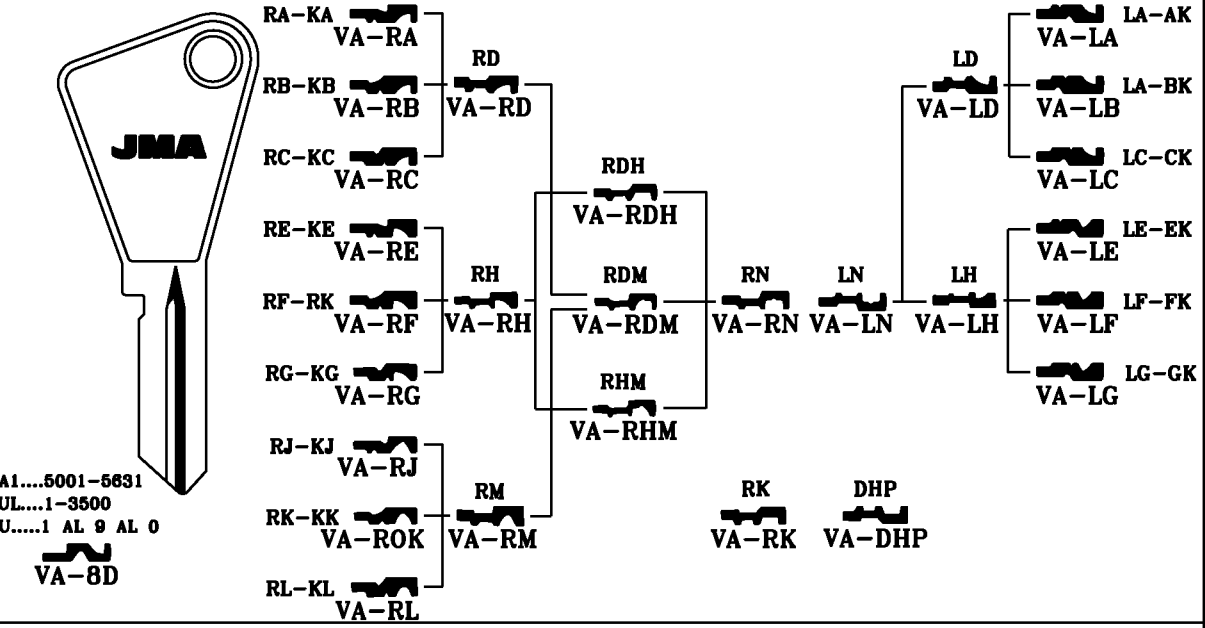

PARA:  
FOR:

### VACHETTE

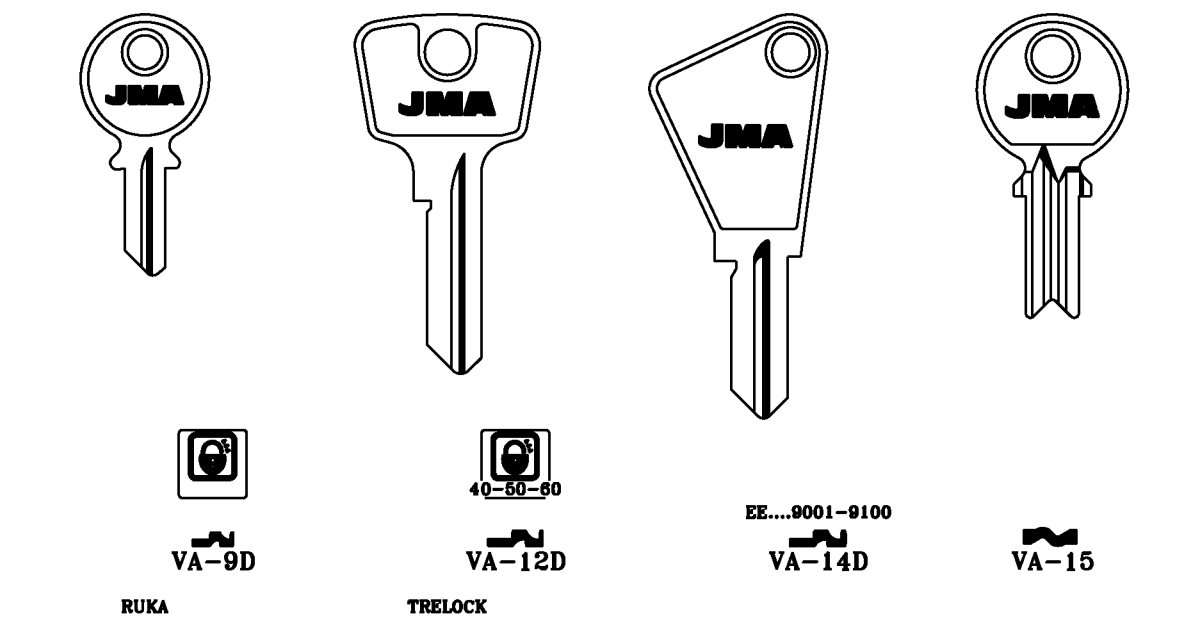

Copyright by  
Alejandro Altuna S.A.  
2005

**JMA**

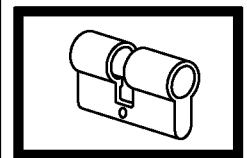

**111**

**PARA-FOR:**  
**VACHETTE (F)**

**PARA:**  
**FOR:** **VACHETTE**

ALP. ALP.

7.85 3.3 VA-25 7.85 3.3 VA-27 7.87 3.3 VA-56

VA-24I VA-24D VA-26 VA-28

RADIAL RADIAL

**PARA:**  
**FOR:** **VACHETTE**

20-25 40-60-60

VL..A0-H9 WL..A0-H9  
VA-29 VA-29D  
K..A0-H9  
RL..A0-H9 BL..A0-H9  
VA-35 VA-35D

VA-30 VA-62 VA-62D

.....  
1 AL 8  
VA-31D

DAD-JU VINCO

**PARA:**  
**FOR:** **VACHETTE**

AY...0-249  
Y...0-249  
VA-32D

VA-33D

Copyright by  
Alejandro Altuna S.A.  
2005

**JMA**

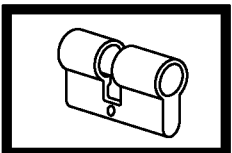

**112**

PARA:  
FOR:

### VACHETTE

PARA-FOR:

### VACHETTE (F)

VARIOS

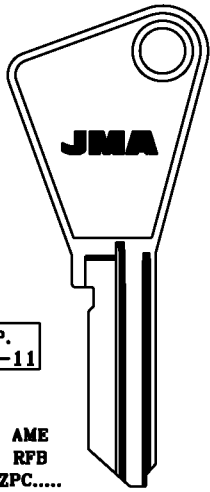

ALP.  
VA-11

AME  
RFB  
ZPC.....  
3 AL 8  
VA-11

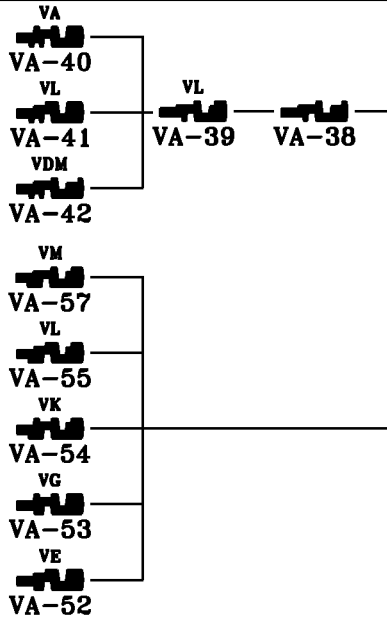

KLM  
ZPC.....  
3 AL 8  
VA-36

VA-43

K007  
L007  
M007  
VA-48

VA-49  
VA-50  
VA-51

VA-44  
VB  
VA-45  
VF  
VA-46  
VJ  
VA-47

PARA:  
FOR:

### VACHETTE

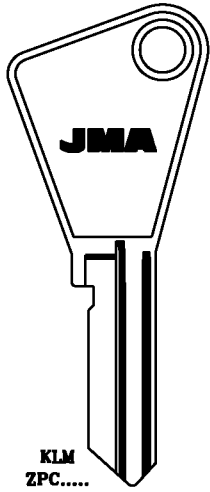

KLM  
ZPC.....  
3 AL 8  
VA-37

ALP.

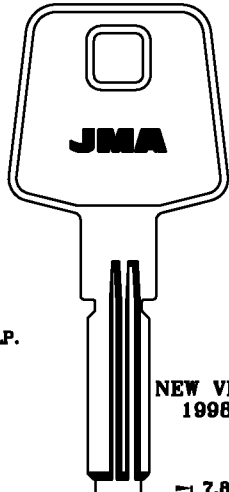

NEW VER.  
1998

7.85  
3.3  
VA-58

RADIAL



VA-59

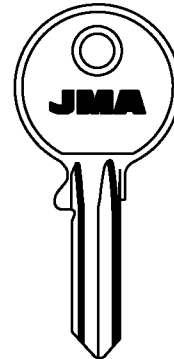

VA-60

SANPEUR

PARA: VACHETTE  
FOR:

### VARIOS

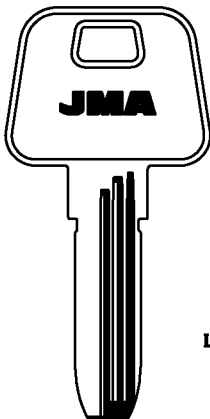

LAT.

8.5  
V6  
VA-70  
2.35

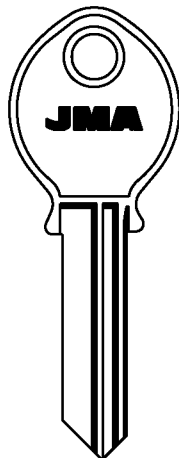

6-C

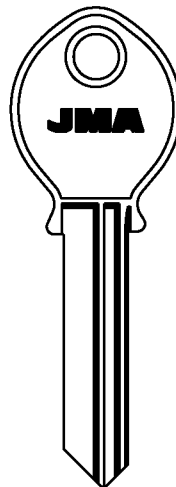

6-L

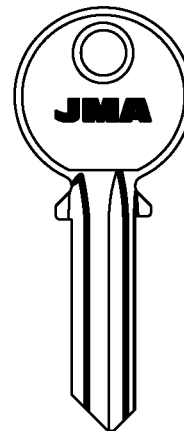

35-I

35-D

38-I

38-D

Copyright by  
Alejandro Altuna S.A.  
2005

JMA

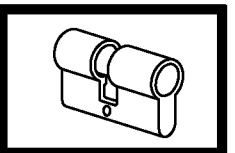

113

**PARA-FOR:**

PARA:  
FOR:

**VARIOS**

- VARIOS
- VEGA (F)
- VENDI (RO)
- VGf
- VILLATORE (I)
- VING (N)
- VIRO (I)

JMA-1I	JMA-1D	JMA-2I	JMA-2D	JMA-3I	JMA-3D	JMA-4I	JMA-4D	JMA-9I	JMA-9D
RONEO-UCEM BOMORO									

• LAT.  
ALU.

PARA: FOR: <b>VEGA</b>	<b>VENDI</b>	<b>VGf VILLATORE</b>
VE-1D	VND-1	VGF-4I
VACHETTE		
	VND-1D	VGF-4D
	VND-2	VGF-5I
	VND-2D	VGF-5D
	VND-3	

PARA: FOR: <b>VING</b>	<b>VIRO</b>
VIN-1D	VI-7
	VI-9D
	VI-11
	VI-1D
	VI-12
	VI-2I
	VI-2D
	ABUS-BERAM-ROYAL

ALU.  
LAT.

ALU.

Copyright by  
Alejandro Altuna S.A.  
2005

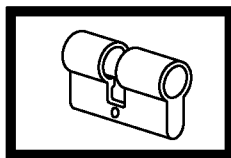

ATENCION:Concerniente a las marcas y denominaciones comerciales ver nota en indice.ATTENTION:Concerning the marks and commercial denominations see note in index. ATTENTION:Concernant les marques et denominations commerciales voir la note dans l'index.ACHTUNG:Beziehen auf die marke und handelsname sehen sie die notiz im index.

PARA:  
FOR:

### VIRO

PARA-FOR:

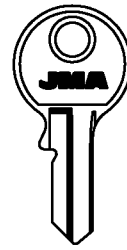
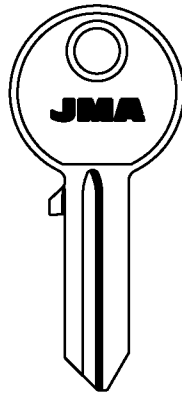
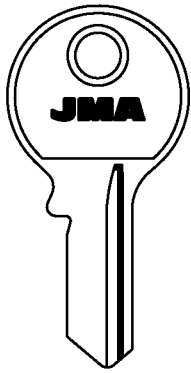

VIRO (I)

VOLGOGRAD  
(RUS)

VOLKOVYSK  
(RUS)

WALLY (RC)



....0 AL 5



ABT

ABUS-ROYAL

ABT

ABUS-BURG

PARA:  
FOR:

### VIRO

### VOLGOGRAD

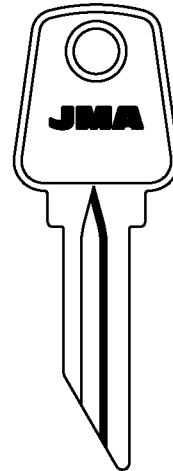
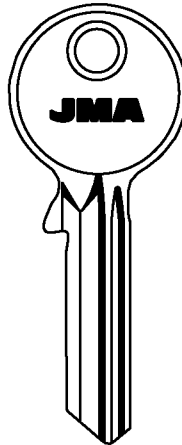
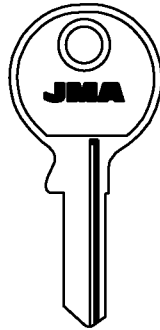
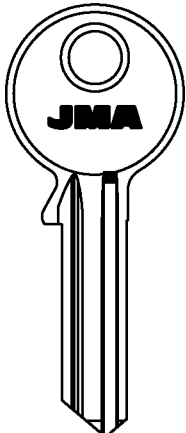

.....  
0 AL 7

SPECIAL



PARA:  
FOR:

### VOLKOVYSK

### WALLY

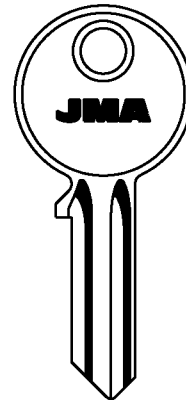
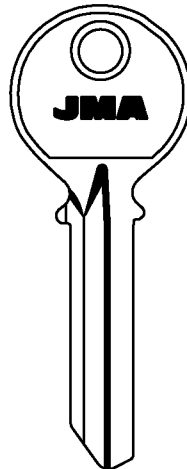
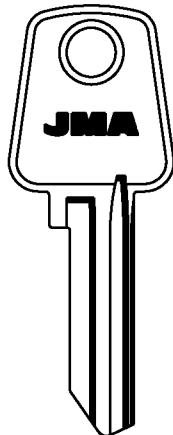
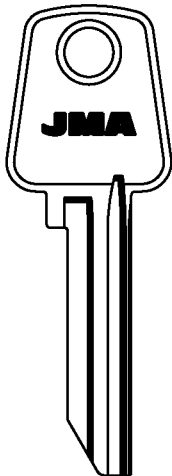

VLK-1

VLK-2

WA-1D

WA-4I

WA-4D

Copyright by  
Alejandro Altuna S.A.  
2005

# JMA

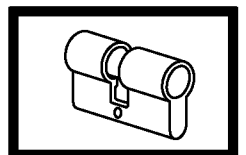

## 115

**PARA-FOR:**

**WALLY (RC)**





**WALRUS (RC)**





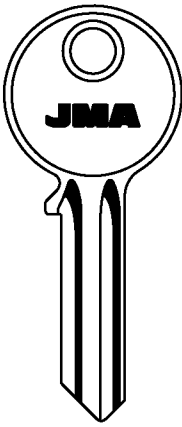

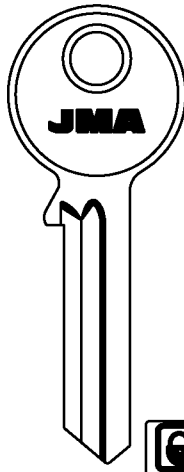
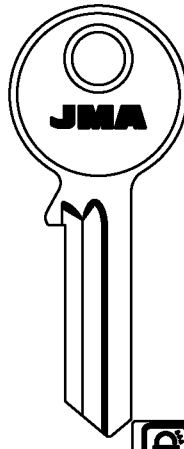
**WEBER (D)**



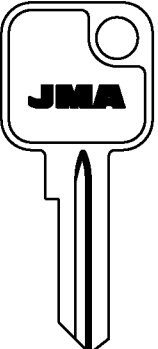

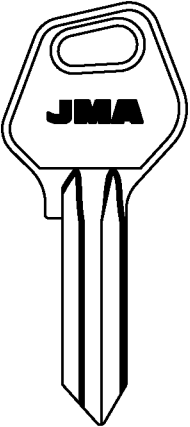
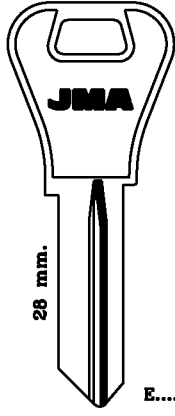

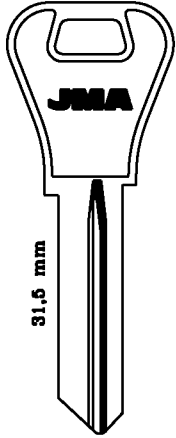

**WEBSTER (GB)**

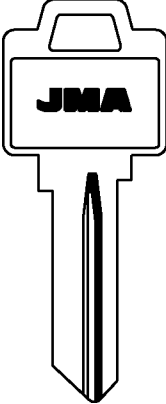
**WEISER (USA)**

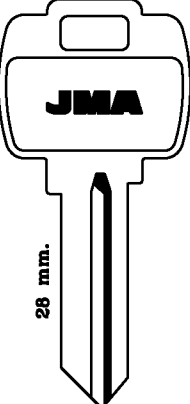
**WELKA (I)**

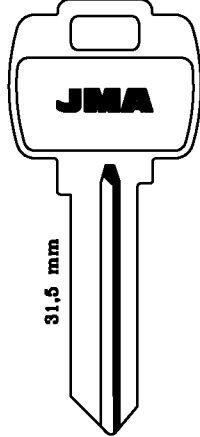
<b>PARA: FOR:</b>	<b>WALLY</b>	<b>WALRUS</b>
	   WA-5I    WA-5D    WA-5IP    WA-5DP MOREAUX	    WAL-1D    WAL-2D

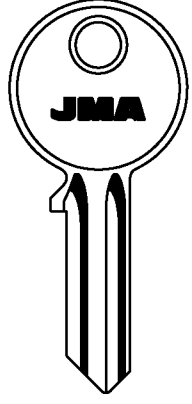
<b>PARA: FOR:</b>	<b>WEBER</b>	<b>WEBSTER</b>	<b>WEISER</b>
	 WEB-1  WEB-2  WEB-3 WECO	 WBS-1	 28 mm. E.....0 AL 9 .....0 AL 9  WEI-1 .....0 AL 9  WEI-6 KAWE
			 31,5 mm E.....0 AL 9 .....0 AL 9  WEI-2 FALCON-FICHET

<b>PARA: FOR:</b>	<b>WEISER</b>	<b>WELKA</b>
	 ALU. E.....0 AL 9 .....0 AL 9  WEI-3 IDEAL SECURITY	 28 mm. E.....0 AL 9 .....0 AL 9  WEI-4 FALCON
	 31,5 mm E.....0 AL 9 .....0 AL 9  WEI-5 FALCON	 .....0 AL 5  WE-4I    WE-4D

Copyright by  
Alejandro Altuna S.A.  
2005

**JMA**

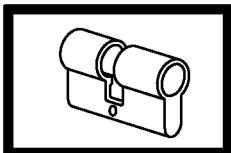

**116**

<b>PARA: FOR:</b> WELKA	WESLOCK	WEST LOCK	
 .....0 AL 5 WE-5I WE-5D	 WES-1D	 V.... 1 AL 6 WST-1D	 V.... 1 AL 6 WST-2D

**PARA-FOR:**

**WELKA (D)**

**WESLOCK (USA)**

**WEST LOCK (USA)**

**WILKA (D)**

<b>PARA: FOR:</b>	WILKA			
 ALU. ..... 1 AL 9 WIL-1D WIL-7 JORE-WIGRO	 WIL-2D	 WIL-3D CFP-GBS	 ..... 1 AL 9 WIL-4D WIL-4D JORE-WIGRO	

<b>PARA: FOR:</b>	WILKA			
 LAT. • WIL-19D	 WIL-5	 ..... 1 AL 9 WIL-5D	 WIL-14	 WIL-15
	 WIL-8		 WIL-12	 WIL-13
	 • WIL-9		 WIL-10	 WIL-11
	 WIL-18			

Copyright by  
Alejandro Altuna S.A.  
2005

**JMA**

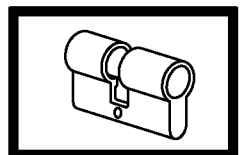

**117**











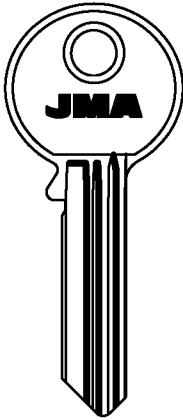

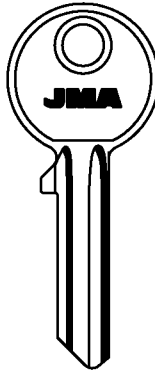
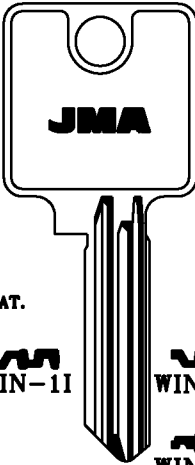

**PARA-FOR:**

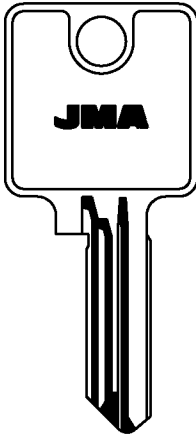
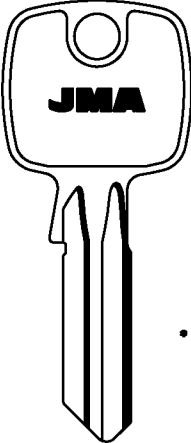
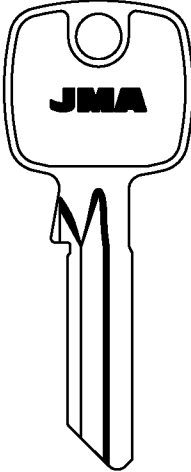
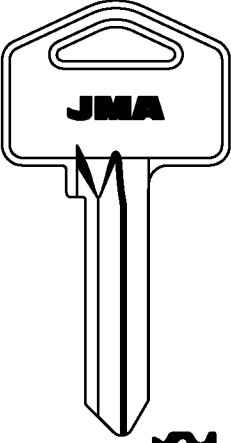
**WILKA (D)**

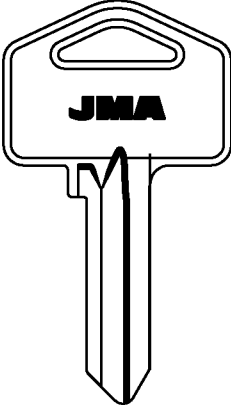
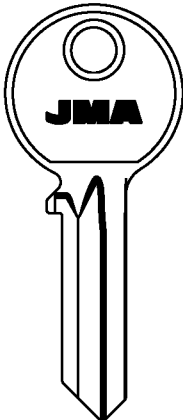
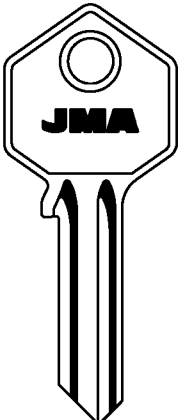
**WINKHAUS (D)**

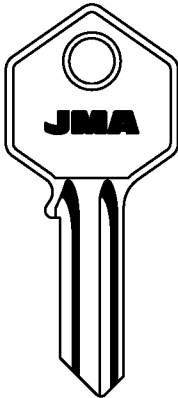
**WMS (GB)**

**YALE (D-GB-USA)**

<p>PARA: WILKA FOR:</p>  <p>WIL-16</p>  <p>WIL-17D</p>  <p>WIL-20</p>	<p>WINKHAUS</p>  <p>LAT. WIN-11</p>  <p>ALP. WIN-1D</p>  <p>WIN-2D</p>  <p>WIN-3D</p>  <p>ALP. WIN-4D</p> <p>AZBE AZBE</p>
<p>PARA: WINKHAUS FOR:</p>  <p>WIN-5</p> <p>• ALP. ACE.</p>  <p>WIN-5D</p>  <p>WIN-6D</p>	<p>WMS</p>  <p>WM-1D</p>  <p>WM-2D</p>  <p>WM-3D</p>
<p>PARA: WMS FOR:</p>  <p>WM-4D</p>	<p>YALE</p>  <p>ALU. COL. YA-11</p>  <p>YA-1D</p> <p>.....0 AL 9</p>  <p>YA-32D</p> <p>WALE</p>  <p>ALU. COL. YA-21</p>  <p>YA-2D</p> <p>.....0 AL 9</p>  <p>YA-31</p>  <p>YA-3D</p> <p>WALE</p>

Copyright by Alejandro Altuna S.A. 2005

**JMA**

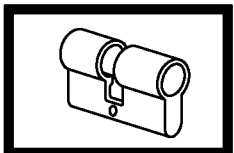

**118**

PARA:  
FOR:

# YALE

PARA-FOR:

**YALE  
(D-GB-USA)**

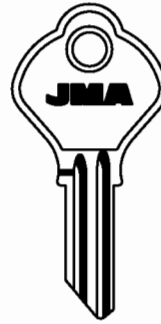

D  
ALU.  
COL.

BKS  
BIRD  
CARAT  
LAREDO  
ROC  
WOC

D GB

GB



YA-5I YA-5D

MIGNON

....0 AL 9  
YA-6I YA-6D



R..101-150  
YA-7I YA-7D

SX...1-1000  
VR...1-4000  
BX...1-500

YA-16D

BKS-WECO

DC...551-952  
YA-8I YA-8D



YA-9I



PARA:  
FOR:

# YALE



GB

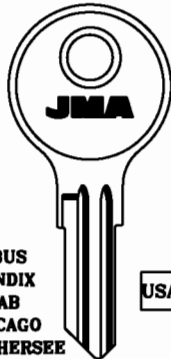

ABUS  
BENDIX  
CAB  
CHICAGO  
COLE HERSEE

USA GB

ALU.



D GB



LT...1-100  
LC...1-100  
YA-10 YA-10D



YA-11I YA-11D



ABG....  
7537-8336

YA-12I YA-12D

YA-13I YA-13D

BKS

PARA:  
FOR:

# YALE

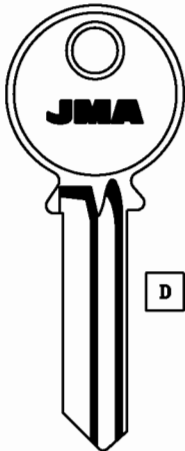

D GB

YA-17I YA-17D

YA-26I

YA-29

PBS  
YA-39 YA-39D

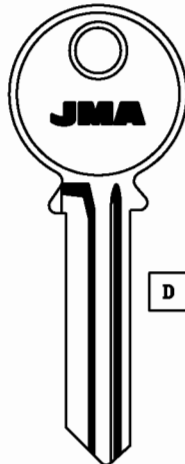

D GB

Y L  
YA-15I YA-15D

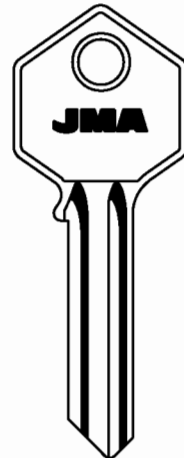

ALU.  
COL.

....0 AL 9  
YA-22I YA-22D

Copyright by  
Alejandro Altuna S.A.  
2005

# JMA

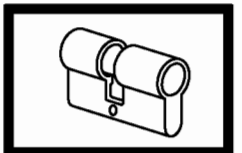

**PARA-FOR:**

**YALE  
(D-GB-USA)**

**PARA: YALE**  
**FOR:**

ALP. ALU.  
COL.  
FSH.

GB

D GB

USA GB

ABUS  
BENDIX  
CAB  
CHICAGO  
COLE HERSEE

...500-550

YA-23 YA-24I YA-24D YA-25I YA-25D YA-27 YA-27D

**PARA: YALE**  
**FOR:**

V G  
YA-28 YA-28D

Y L  
YA-53 YA-53D

YA-30

YA-31D

YA-33D

**PARA: YALE**  
**FOR:**

LAT.

YA-34D YA-36D YA-37 YA-37D YA-38D

ADEMCO-BENDIX-CHICAGO  
FORT-ILLINOIS

Copyright by  
Alejandro Altuna S.A.  
2005

**JMA**

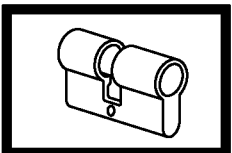

**120**

**PARA:** YALE  
**FOR:**

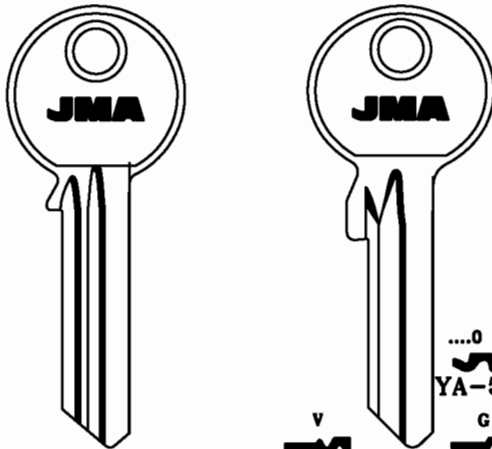

....0 AL 9  
YA-52D

v G  
YA-51 YA-51D

X5 Y L  
YA-46D YA-50 YA-50D

**PARA:** YARDENI  
**FOR:**

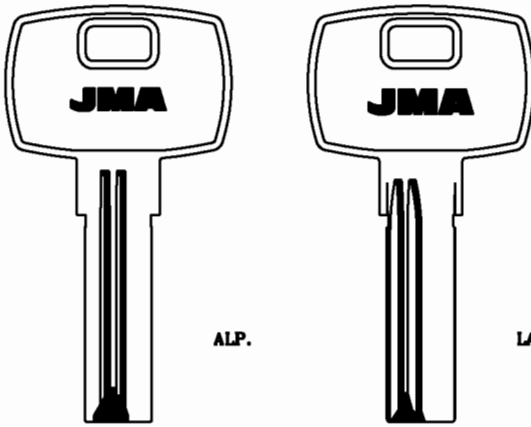

ALP. LAT.

8.85 8.9  
2.45 2.45  
YAR-1 YAR-2

**PARA-FOR:**

**YALE**  
**(D-GB-USA)**

**YARDENI (IL)**

**YETI (RC)**

**PARA:** YETI  
**FOR:**

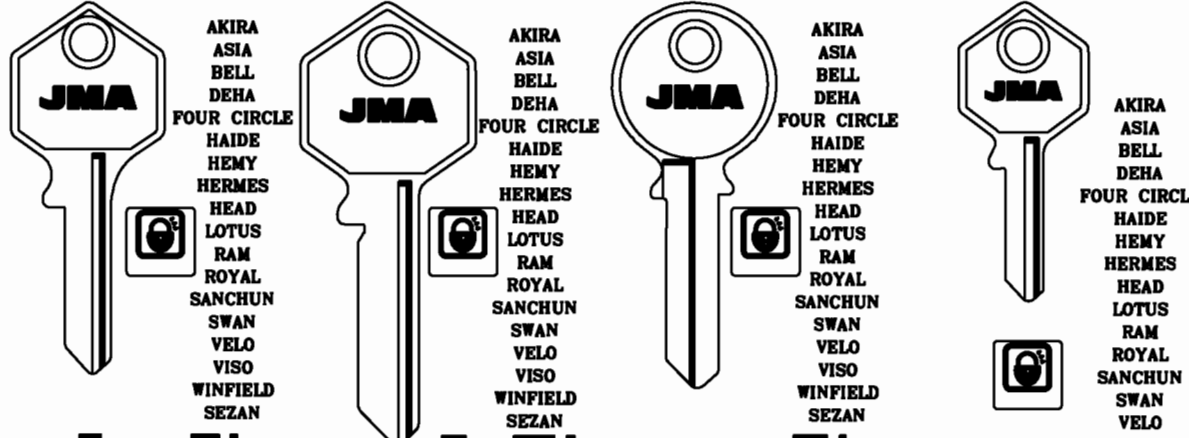

AKIRA ASIA BELL DEHA FOUR CIRCLE HAIDE HEMY HERMES HEAD LOTUS RAM ROYAL SANCHUN SWAN VELO VISO WINFIELD SEZAN

AKIRA ASIA BELL DEHA FOUR CIRCLE HAIDE HEMY HERMES HEAD LOTUS RAM ROYAL SANCHUN SWAN VELO VISO WINFIELD SEZAN

AKIRA ASIA BELL DEHA FOUR CIRCLE HAIDE HEMY HERMES HEAD LOTUS RAM ROYAL SANCHUN SWAN VELO VISO WINFIELD SEZAN

AKIRA ASIA BELL DEHA FOUR CIRCLE HAIDE HEMY HERMES HEAD LOTUS RAM ROYAL SANCHUN SWAN VELO VISO WINFIELD SEZAN

YET-1 YET-1D YET-2 YET-2D YET-3D YET-4 YET-4D

YET-14 YET-14D YET-16 YET-15

**PARA:** YETI  
**FOR:**

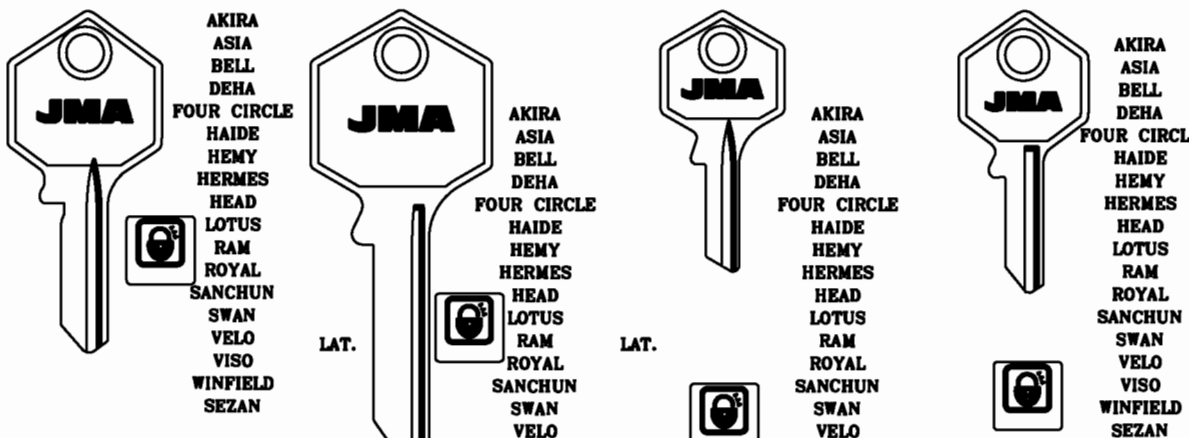

AKIRA ASIA BELL DEHA FOUR CIRCLE HAIDE HEMY HERMES HEAD LOTUS RAM ROYAL SANCHUN SWAN VELO VISO WINFIELD SEZAN

AKIRA ASIA BELL DEHA FOUR CIRCLE HAIDE HEMY HERMES HEAD LOTUS RAM ROYAL SANCHUN SWAN VELO VISO WINFIELD SEZAN

AKIRA ASIA BELL DEHA FOUR CIRCLE HAIDE HEMY HERMES HEAD LOTUS RAM ROYAL SANCHUN SWAN VELO VISO WINFIELD SEZAN

AKIRA ASIA BELL DEHA FOUR CIRCLE HAIDE HEMY HERMES HEAD LOTUS RAM ROYAL SANCHUN SWAN VELO VISO WINFIELD SEZAN

YET-5 YET-5D YET-6 YET-6D YET-7 YET-7D YET-8 YET-8D YET-9 YET-9D YET-13

LAT. LAT.

Copyright by  
Alejandro Altuna S.A.  
2005

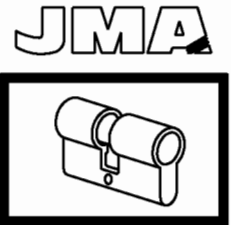

**121**









ATENCIÓN: Concerniente a las marcas y denominaciones comerciales ver nota en índice. ATTENTION: Concerning the marks and commercial denominations see note in index. ACHTUNG: Beziehen auf die Marke und Handelsname sehen sie die notiz im index.





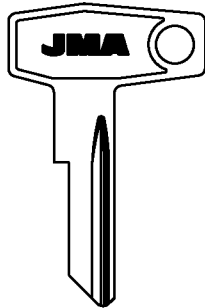

**PARA-FOR:**

**YETI (RC)**

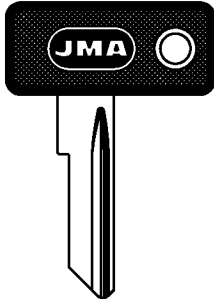
**ZADI (I)**

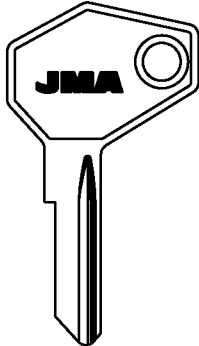
**ZENI (GB)**

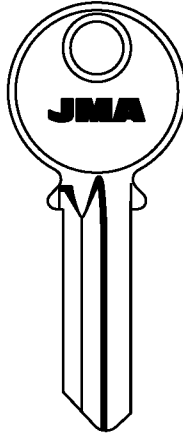
	<p><b>PARA: FOR:</b></p> <p><b>YETI</b></p>	<p><b>PARA: FOR:</b></p> <p><b>ZADI</b></p>
  <p>YET-10    YET-10D</p>	  <p>YET-11    YET-11D</p>	  <p>YET-12</p>
	<p>AKIRA ASIA BELL DEHA FOUR CIRCLE HAIDE HEMY HERMES HEAD LOTUS RAM ROYAL SANCHUN SWAN VELO VISO WINFIELD SEZAN</p>	<p>AKIRA ASIA BELL DEHA FOUR CIRCLE HAIDE HEMY HERMES HEAD LOTUS RAM ROYAL SANCHUN SWAN VELO VISO WINFIELD SEZAN</p>
		  <p>....1-1625 ....5001-6278 E...1-710 ZA-1 BRETER</p>

<p><b>PARA: FOR:</b></p> <p><b>ZADI</b></p>	<p><b>PARA: FOR:</b></p> <p><b>ZADI</b></p>	<p><b>PARA: FOR:</b></p> <p><b>ZENI</b></p>	
  <p>....1-1625 ....5001-6278 E...1-710 ZA-1.P BRETER</p>	  <p>....1-1625 ....5001-6278 E...1-710 ZA-12 BRETER</p>	  <p>ZEN-1D</p>	

Copyright by  
Alejandro Altuna S.A.  
2005

**JMA**

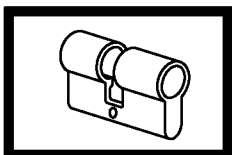



**JMA** 

**LLAVES PARA VEHÍCULOS**

**IBILGAILUENTZAKO GILTZAK**

**KEYS FOR VEHICLES**

**CLÉS POUR VÉHICULES**

**FAHRZAUGESCHLÜSSEL**

**CHIAVI PER VEICOLI**

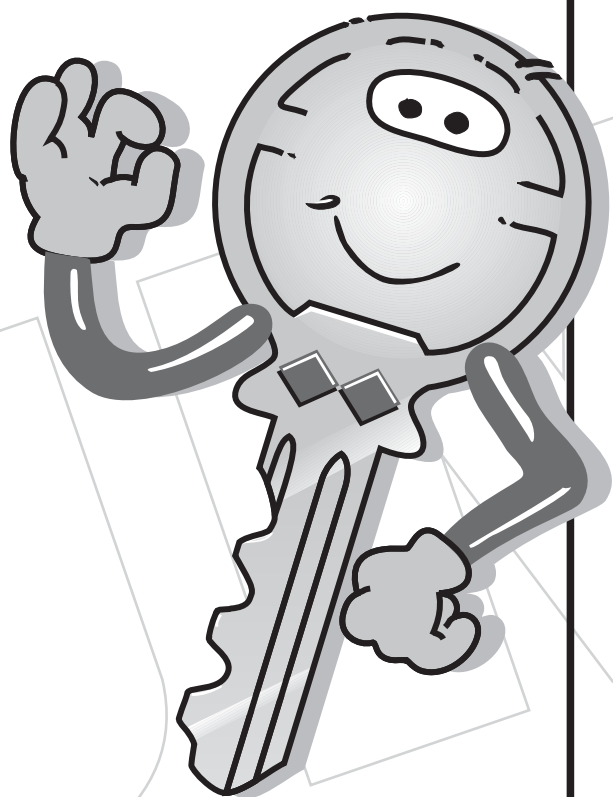

PARA:  
FOR:

ABSA

PARA-FOR:

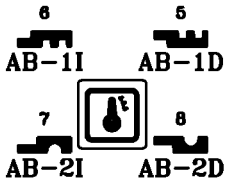
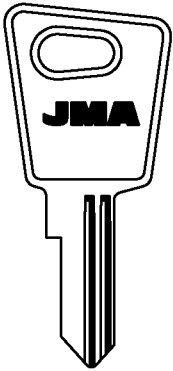

M.LUNA

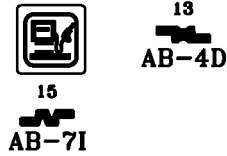
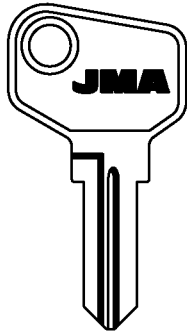

PROAUTO

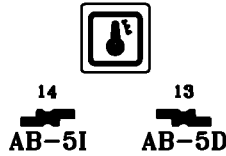
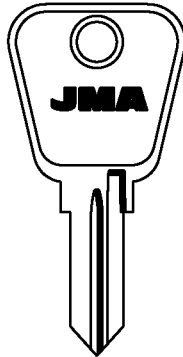

FROSER

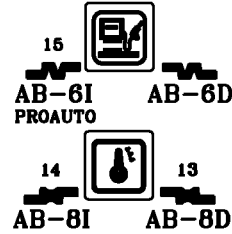
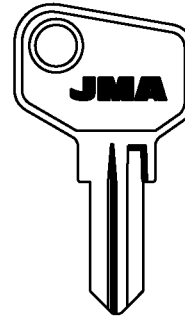

FROSER-KEYA

ABSA (E)  
ABUS (D)  
AKS (D)  
ALPHA (J)

PARA:  
FOR:

ABSA

ABUS

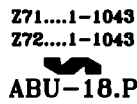
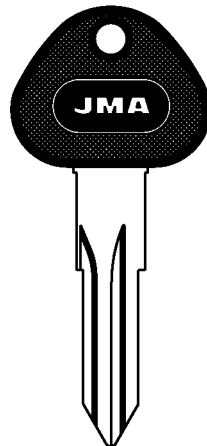
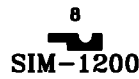
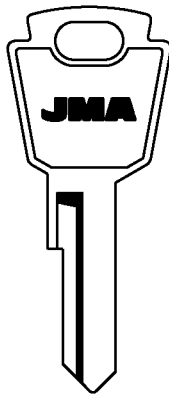
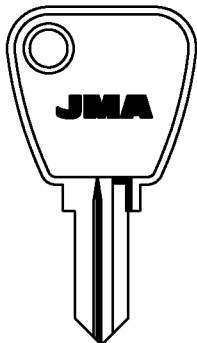

BUFFO

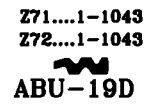
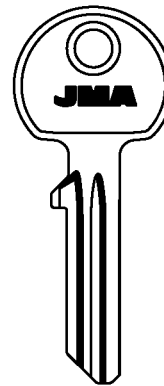

BUFFO

PARA:  
FOR:

ABUS

AKS

ALPHA

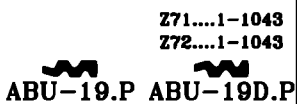
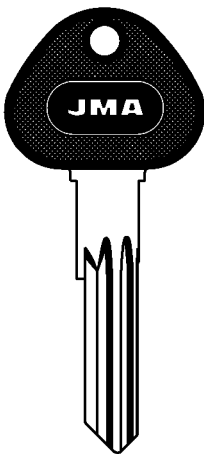

BUFFO

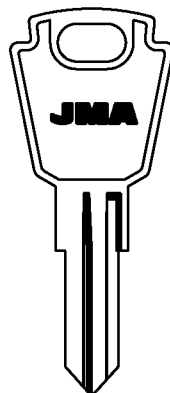
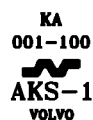
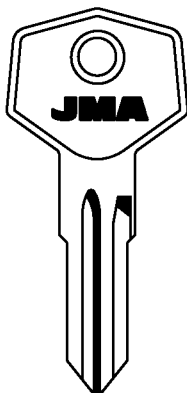

FEB

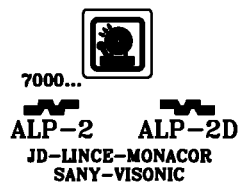
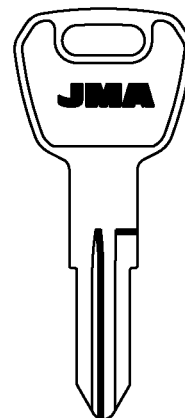

Copyright by  
Alejandro Altuna S.A.  
2005

JMA

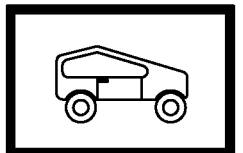

125

**PARA-FOR:**









**AMERICAN MOTORS (USA)**

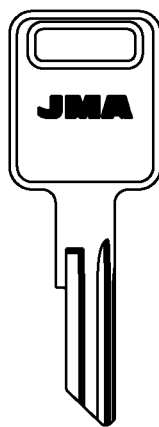

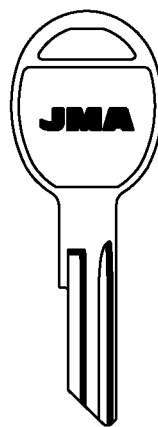



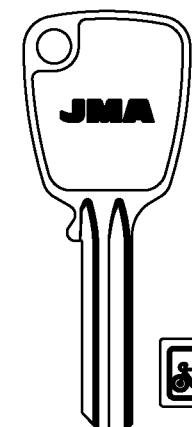

**ASSA (S)**

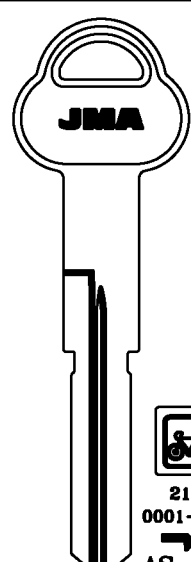

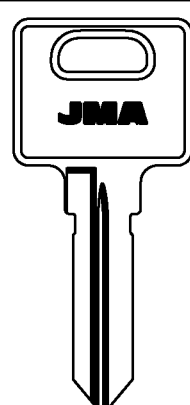

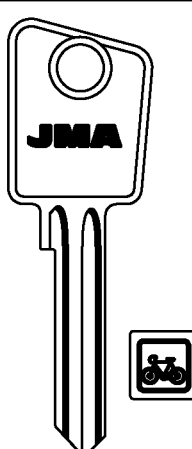

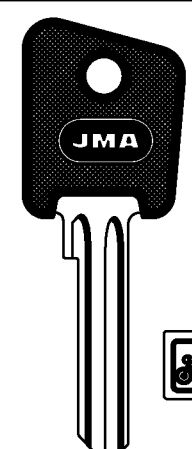

**AXA (S)**

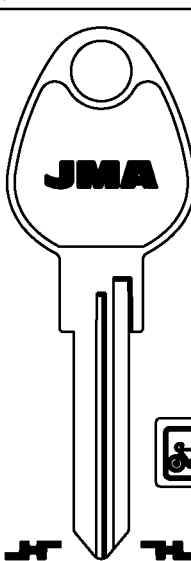
**AZU (E)**

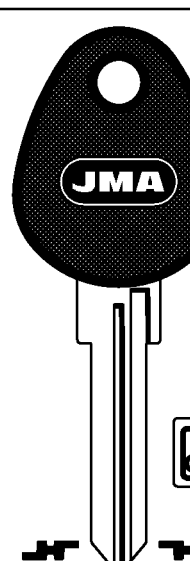
**BASCO (USA)**

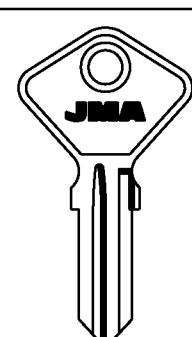
<p><b>PARA: AMERICAN MOTORS</b> <b>FOR:</b></p> <div style="display: flex; justify-content: space-around;"> <div style="text-align: center;">  <p>LAT.</p>  <p>AMM-1</p> </div> <div style="text-align: center;">  <p>LAT.</p>  <p>AMM-2</p> </div> </div>	<p><b>ASSA</b></p> <div style="display: flex; justify-content: space-around;"> <div style="text-align: center;">  <p>AS-1I</p>  <p>7... 8... 1001-3300</p>  <p>AS-24</p> </div> <div style="text-align: center;">  <p>AS-1D</p>  <p>8... 1... 1001-3300</p>  <p>AS-24D</p> <p>SAAB-VOLVO</p> </div> </div>
--	---

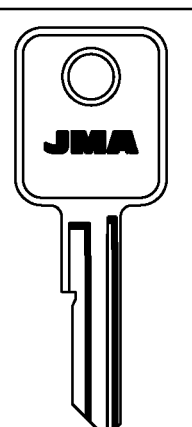
<p><b>PARA: ASSA</b> <b>FOR:</b></p>			
 <p>AS-17D</p>  <p>21... 0001-9999</p> <p>BICICLETTA CYCLES</p>	 <p>AS-19D</p>  <p>21... 0001-9999</p>	 <p>AS-21</p>  <p>7000-7999 A... 7000-7999</p>	 <p>AS-21D</p>  <p>8000-9999 A... 9000-9999</p>





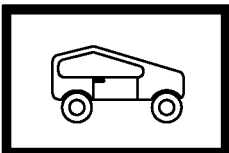

<p><b>PARA: AXA</b> <b>FOR:</b></p> <div style="display: flex; justify-content: space-around;"> <div style="text-align: center;">  <p>AX-1</p>  </div> <div style="text-align: center;">  <p>AX-1D</p>  </div> </div>	<p><b>AZU</b></p> <div style="text-align: center;">  <p>28-D</p>  <p>DKW</p> </div>	<p><b>BASCO</b></p> <div style="text-align: center;">  <p>BAS-1I</p>  </div> <p>E,D 225-814 K 0001-1000 8000-9499</p> <p>BAS-1I BAS-1D</p> <p>GENERAL MOTORS-HOLDEN CORBIN</p>
---	--	--

Copyright by  
Alejandro Altuna S.A.  
2005

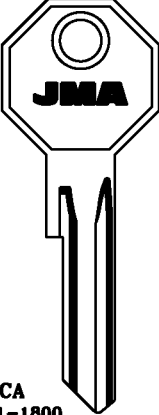
**JMA**

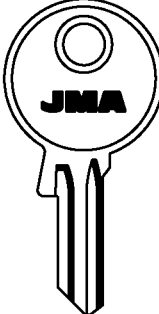
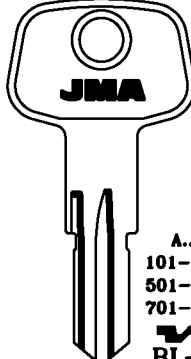

**126**

<p><b>PARA:</b> BASCO <b>FOR:</b></p>  <p>CA 0001-1800</p>   <p>BAS-21 BAS-2D D,C,P,D BAS-3</p>  <p>BAS-4</p> <p>CORBIN-YALE AMERICAN M.-B&amp;S-CHICAGO C. ELMO-HERSEE E.-ILLINOIS-YALE</p>	<p><b>BLAU</b></p>   <p>EMOH FLORA KN LINDE POS WESCO</p> <p>55-69 33-54 31-86</p> <p>BL-11 BL-1D</p>   <p>A BL-4 BL-4D</p> <p>FORT-HK-WASO</p>
--	---







**PARA-FOR:**

**BASCO (USA)**

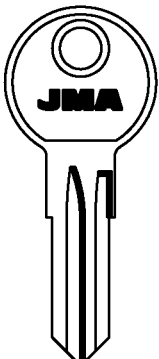
**BLAU (D)**

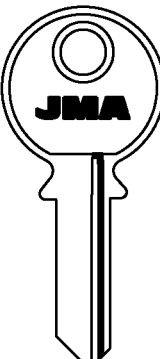
**BOMORO (D)**

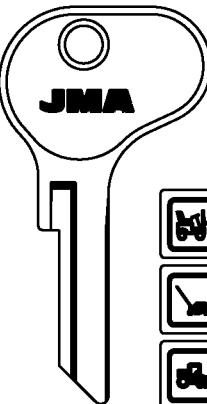
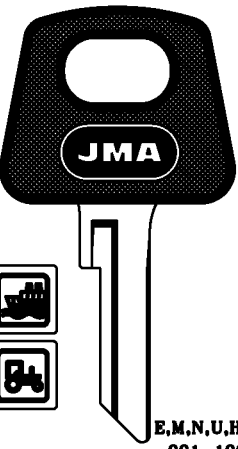
**BOSCH (D)**

<p><b>PARA:</b> BLAU <b>FOR:</b></p>   <p>1-200 RE...1-200</p> <p>BL-5 BL-5D</p>	<p><b>BOMORO</b></p>   <p>BOM-2 BOM-2D</p> <p>LAPORTE-PRESTA</p>	<p><b>BOSCH</b></p>    <p>E,M,N,U,H,K 001-100</p> <p>HG,N HG 140-189 040-100</p> <p>BH-1 BH-1.P</p> <p>NEIMAN NEIMAN</p>
---	---	---

**PARA:** BOSCH  
**FOR:**

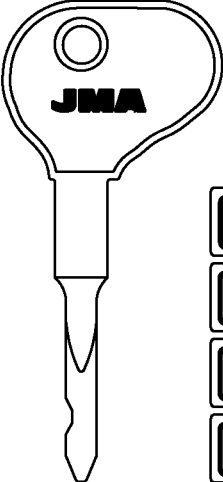
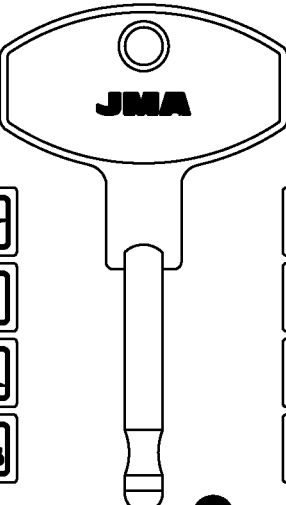
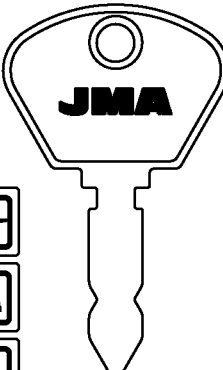
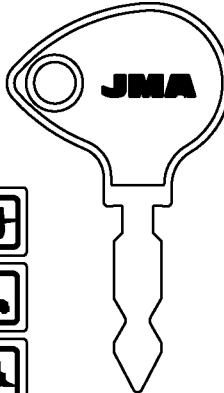
  <p>BH-2 BH-3</p> <p>FIAT IVECO-MACK M.-SCANIA</p>	  <p>BH-4 BH-5</p> <p>DISALCAR-OM IVECO-SULKY KOLB-POLAR</p>
--	---

Copyright by  
Alejandro Altuna S.A.  
2005

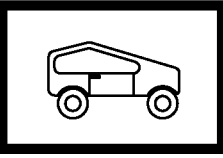
**127**

ATENCION:Concerniente a las marcas y denominaciones comerciales ver nota en indice.ATTENTION:Concerning the marks and commercial denominations see note in Index.  
ATTENTION:Concernant les marques et denominations commerciales voir la note dans l'index.ACHTUNG:Beziehen auf die marke und handelsname sehen sie die notiz im Index.

**PARA-FOR:**

**PARA: FOR: BOSCH**

**B. & S.**

- BOSCH (D)**
- B. & S. (USA)**
- BURG (D)**
- CAMA (I)**
- CASELLAS (E)**
- CATERPILLAR (USA)**
- CEM (GB)**

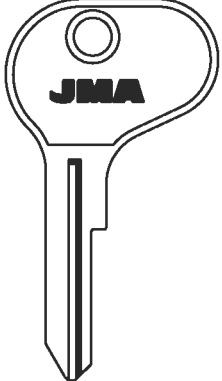

**BH-6**

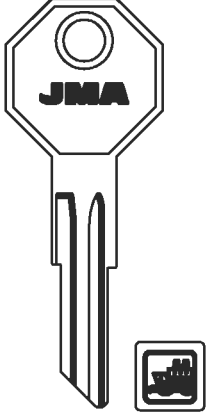

N  
1501-1700  
NA  
001-200  
**BS-11**  
AMERICAN MOTORS-MACK  
DEXTER

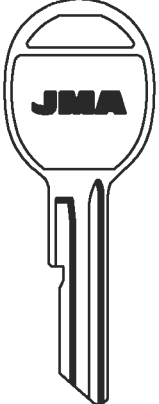

E...225-814  
L...1-1000  
**BS-2**

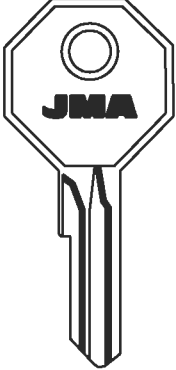

**BS-3D**

**PARA: FOR:**

**B. & S.**

**BURG**

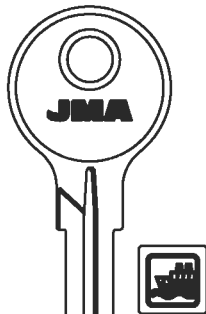

A....250-1500 GC...  
AP....250-1500 101-150  
B....250-1500 HC...  
C....1251-1700 0-499  
CB....250-1500  
DC-EP...250-699  
P....250-1500  
**BS-6**

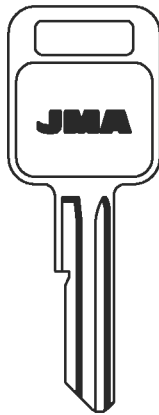

D  
225-814  
K  
01-1000  
**BS-5**



A  
**BS-7**  
D  
**BS-8**  
E  
**BS-9**

CV...1-1500  
C  
**BS-7D**  
BS-8D  
F  
**BS-9D**

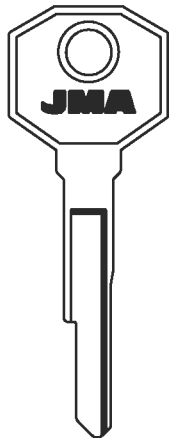

**BUR-6**

**PARA: FOR: CAMA**

**CASELLAS**

**CATERPILLAR**

**CEM**

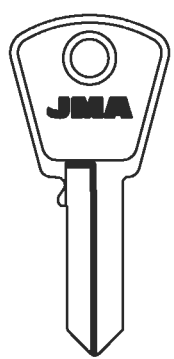

**CAM-1D**  
FIST

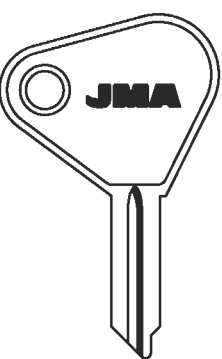

**CAS-1D**  
OSSA

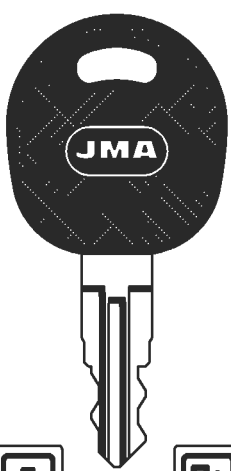

**CAT-1.P**

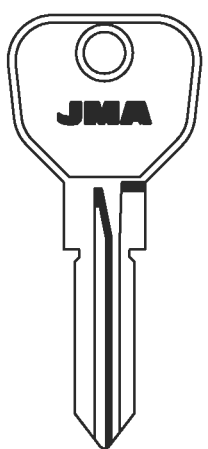







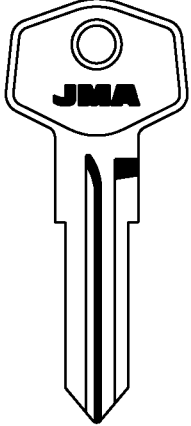
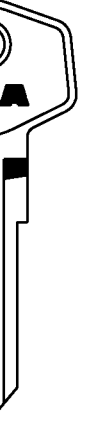
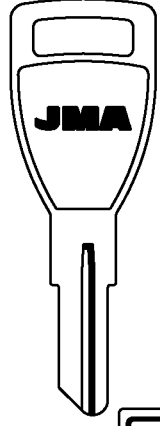
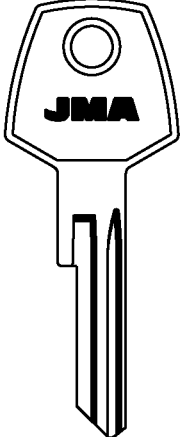
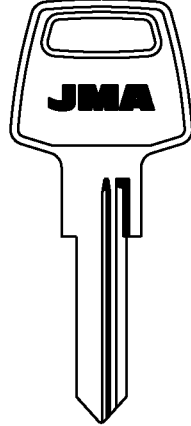

**CEM-BP**

Copyright by  
Alejandro Altuna S.A.  
2005



**128**







<b>PARA: FOR:</b>	<b>CEM</b>	<b>CESSNA</b>	<b>CHRYSLER</b>	
				
JC 001-852	AK 0001-1000	 500-999	 CHR-1	 CHR-2
 CEM-JC	 FO-5	 CN-1D	 YALE	 ROSS
DAIMLER-JAGUAR-ROVER-VOLVO				



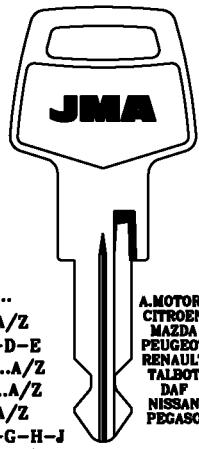
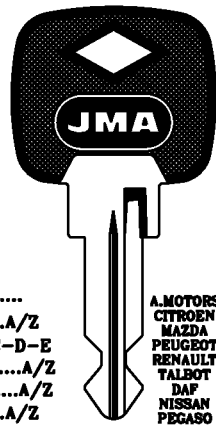
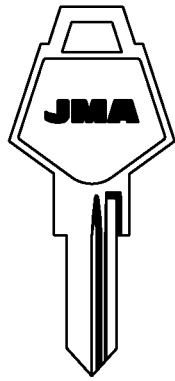
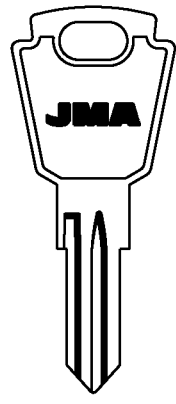



**PARA-FOR:**

**CEM (GB)**

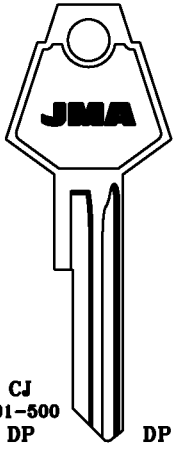
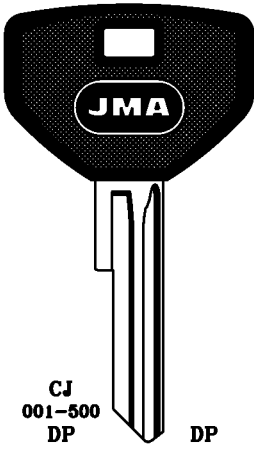
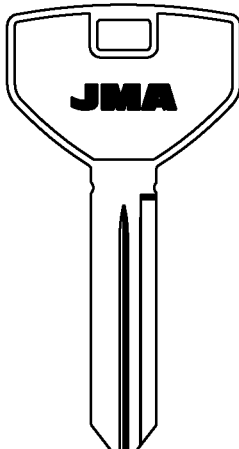
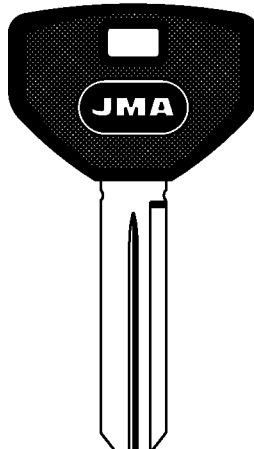
**CESSNA (USA)**

**CHRYSLER (USA)**

<b>PARA: FOR:</b>	<b>CHRYSLER</b>			
				
..... .....A/Z B-C-D-E 1/9.....A/Z 1/9.....A/Z .....A/Z B-D-E-G-H-J .1/9.....A/Z .1/9.....A/Z E-M-N-P-R	A.MOTORS CITROEN MAZDA PEUGEOT RENAULT TALBOT DAF NISSAN PEGASO	..... .....A/Z B-C-D-E 1/9.....A/Z 1/9.....A/Z .....A/Z B-D-E-G-H-J .1/9.....A/Z .1/9.....A/Z E-M-N-P-R	A.MOTORS CITROEN MAZDA PEUGEOT RENAULT TALBOT DAF NISSAN PEGASO	Z 001-224 W 001-224
 CHR-3	 CHR-3.P	 CHR-5	 CHR-6	 CHR-6D
CLAUSOR-NEIMAN	CLAUSOR-NEIMAN	NISSAN-PEGASO ROSS	KIFERM-PJ	

<b>PARA: FOR:</b>	<b>CHRYSLER</b>			
				
CJ 001-500 DP 0001-1400 EP 0001-3000	CJ 001-500 DP 0001-1400 EP 0001-3000	DP 0001-1400 EP 0001-3000	F.... G.... 0000-1394	F.... G.... 0000-1394
 CHR-7	 CHR-7.P	 CHR-8	 CHR-8.P	 CHR-9
CHRYSLER YALE	CHRYSLER YALE	CHRYSLER YALE	AMERICAN MOTORS-CHRYSLER-JEEP YALE	AMERICAN MOTORS-CHRYSLER-JEEP YALE

Copyright by  
Alejandro Altuna S.A.  
2005

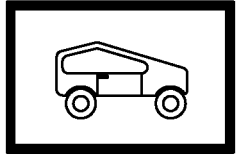

ATENCION:Concerniente a las marcas y denominaciones comerciales ver nota en indice.ATTENTION:Concerning the marks and commercial denominations see note in index.  
ATTENTION:Concernant les marques et denominations commerciales voir la note dans l'index.ACHTUNG:Beziehen auf die marke und handelsname sehen sie die notiz im index.

**PARA-FOR:**

**PARA:  
FOR:**

**CHRYSLER**

**CHRYSLER  
(USA)**

**CLAUSOR (E)**

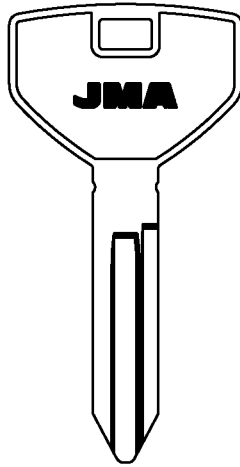

J....  
0001-3580



**CHR-10**

AMERICAN MOTORS-CHRYSLER-JEEP  
YALE

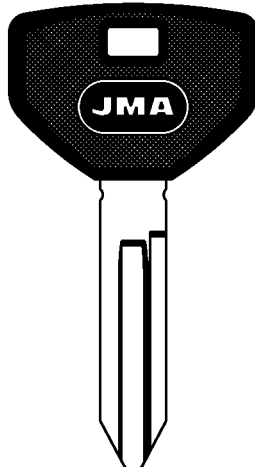

J....  
0001-3580

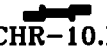

**CHR-10.P**

AMERICAN MOTORS-CHRYSLER-JEEP  
YALE

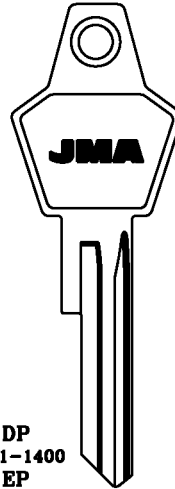

DP  
0001-1400  
EP  
0001-3000



**CHR-11**

CHRYSLER  
YALE

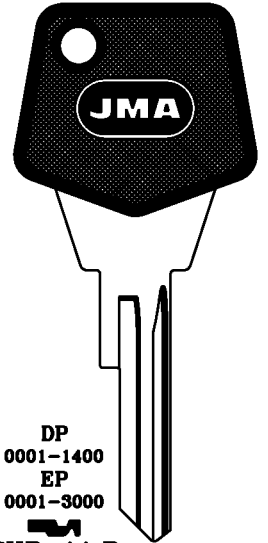

DP  
0001-1400  
EP  
0001-3000

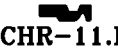

**CHR-11.P**

CHRYSLER  
YALE

**PARA:  
FOR:**

**CHRYSLER**

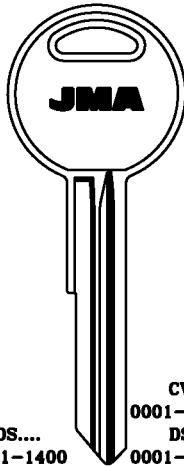

DS....  
0001-1400  
ES....  
0001-3000



**CHR-12**

CHRYSLER  
BRIGGS & STRATTON

CV  
0001-1500  
DS  
0001-1500  
ES  
0001-1500



**CHR-13D**

CHRYSLER  
BRIGGS & STRATTON

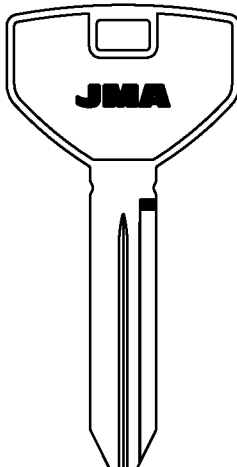

L.... 1-3580



**CHR-14**

CHRYSLER

BRIGGS & STRATTON-YALE

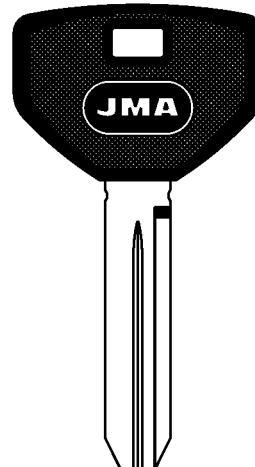

L.... 1-3580



**CHR-14.P**

CHRYSLER

BRIGGS & STRATTON-YALE

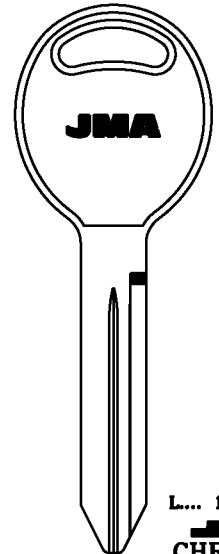

L.... 1-3580



**CHR-15**

CHRYSLER

BRIGGS & STRATTON-YALE

**PARA:  
FOR:**

**CHRYSLER**

**CLAUSOR**

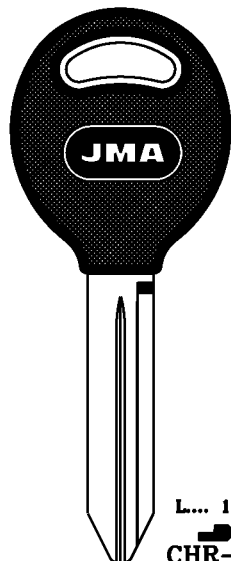

L.... 1-3580 5001-7879



**CHR-15.P**

CHRYSLER

BRIGGS & STRATTON-YALE

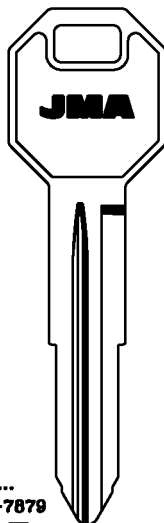

E....



**CHR-17**

CHRYSLER

BRIGGS & STRATTON-YALE

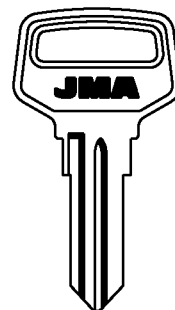

ALU.



**CL-11**



**CL-21**

**CL-2D**

EBRO-CAGIVA-LINCE-MAICO  
MONTESA-OSSA-PIAGGIO VESPA

BRABANTIA

Copyright by  
Alejandro Altuna S.A.  
2005

**JMA**

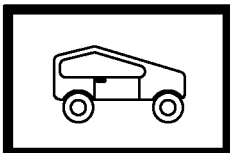

**130**

PARA:  
FOR:

CLAUSOR

PARA-FOR:

CLAUSOR (E)  
CLICK (RA)  
CLUM (USA)  
COBRA (I)

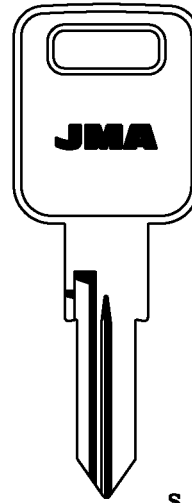
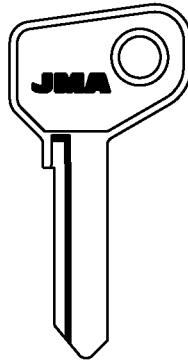
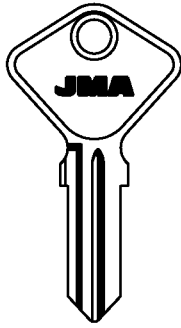
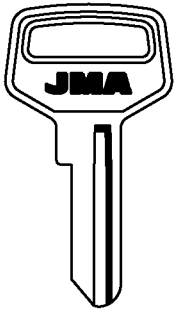

CL-3I

ERRO-CAGIVA-LINCE-MAICO  
MONTESA-OSSA-PIAGGIO VESPA



CL-4I

JEEP



CL-5D



CL-6

SEAT

PARA:  
FOR:

CLAUSOR

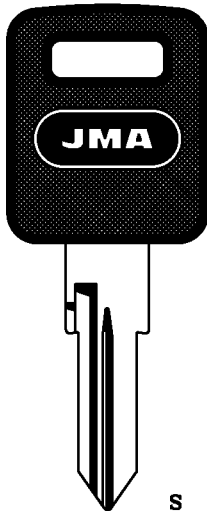

CL-6.P

SEAT

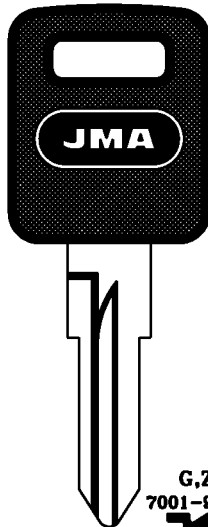

CL-7.P

SEAT  
GIOBERT

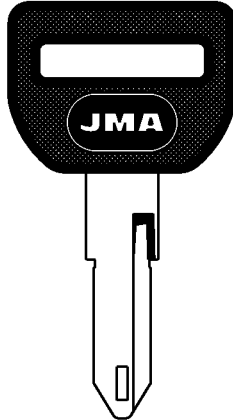

G,Z  
7001-9956

CL-8.P

CITROEN

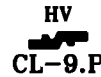
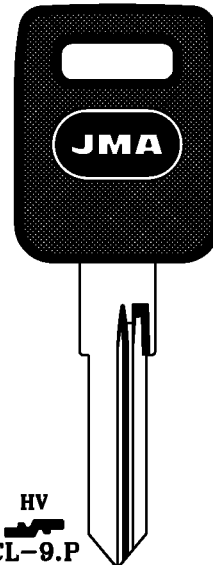

CL-9.P

SEAT

PARA:  
FOR:

CLAUSOR

CLICK

CLUM

COBRA

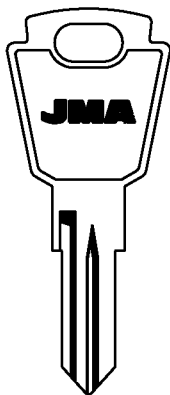

SIM-900

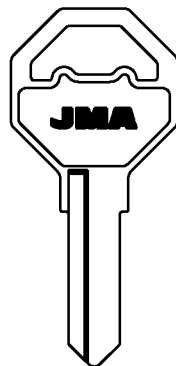

CLI-1D

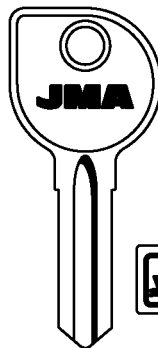

CLU-1I CLU-1D



CLU-2



CLU-3



CLU-4



CLU-5

MERCURY

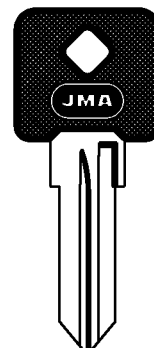

COB-1.P

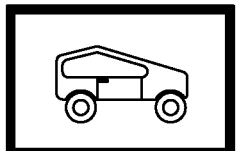

Copyright by  
Alejandro Altuna S.A.  
2005

JMA



131

**PARA-FOR:**

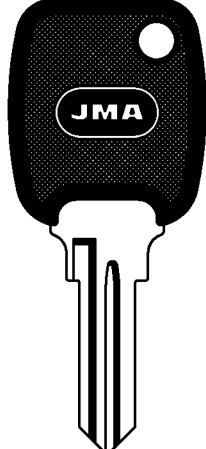
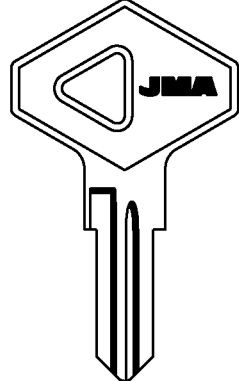
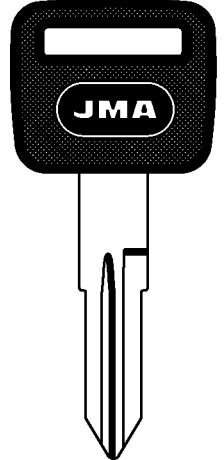
<p><b>PARA: FOR:</b> COBRA</p>    <p><b>COB-2</b></p>	<p><b>DACIA</b></p>   <p><b>DAC-1D.P</b>      <b>DAC-2D</b></p>	<p><b>DAELIM</b></p>  <p><b>DAL-1P</b></p>
--	--	---

**COBRA (I)**

**DACIA (R)**





**DAELIM (K)**

**DAEWOO (K)**

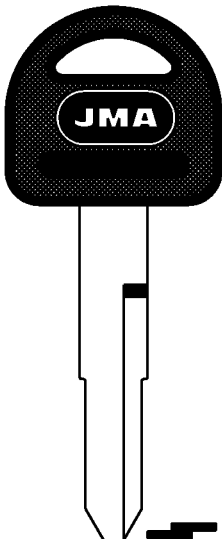
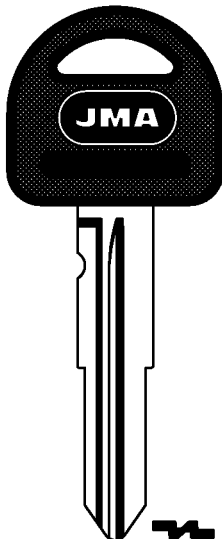
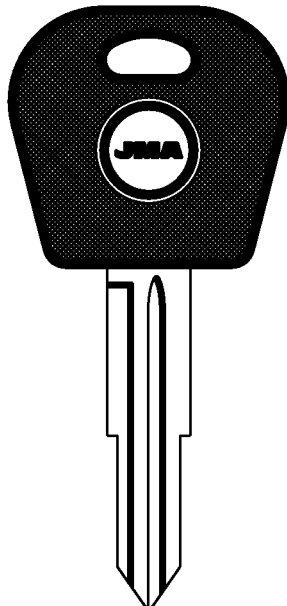
**DAIHATSU (J)**

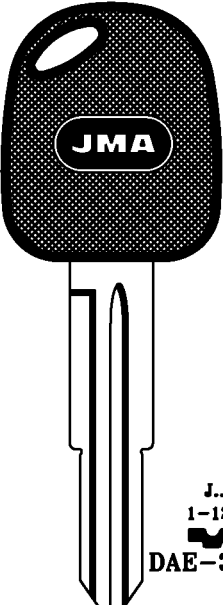
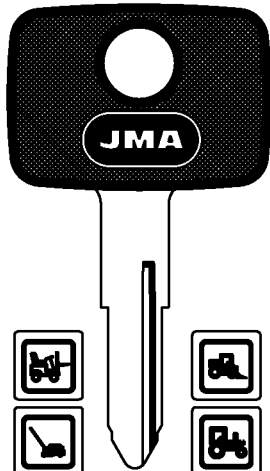
**PARA: FOR:** **DAEWOO**

 <p><b>DAE-1.P</b> DAEWOO</p>	 <p><b>DAE-2D.P</b> DAEWOO</p>	 <p><b>J... 1-1200</b> <b>DAE-3D.P1</b></p> <p><b>V... 1-1200</b> <b>DAE-4.P1</b></p> <p><b>T... 1-1200</b> <b>DAE-4D.P1</b></p>
---	--	---

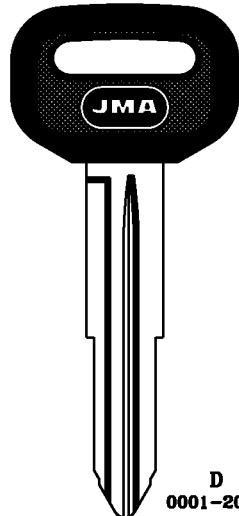
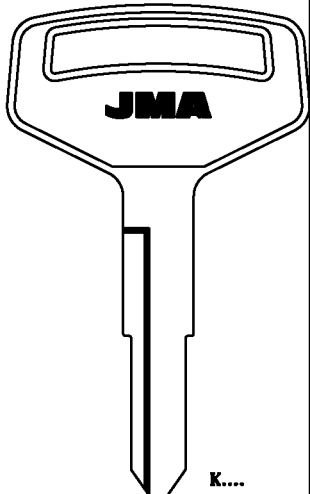





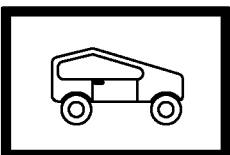



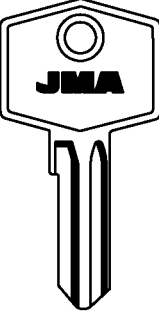

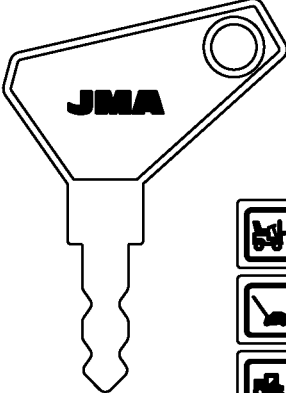
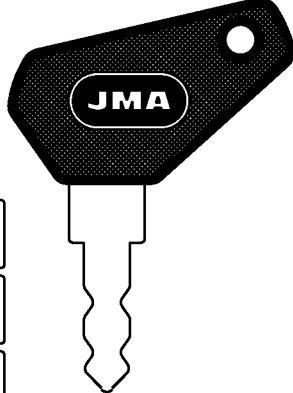



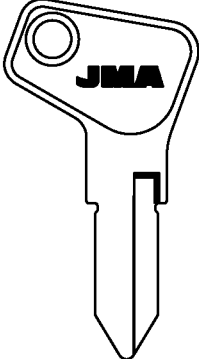
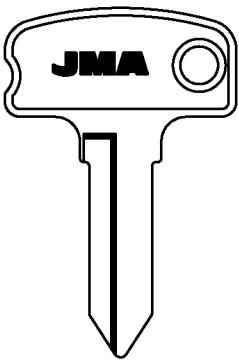

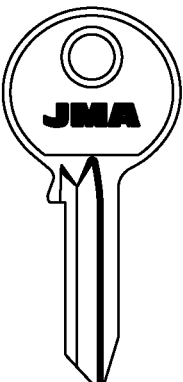

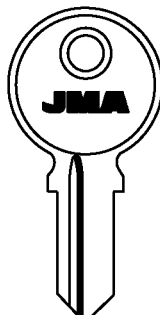
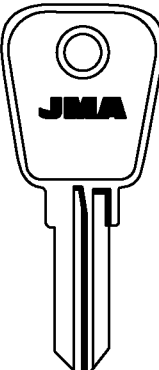
<p><b>PARA: FOR:</b> <b>DAEWOO</b></p>  <p><b>J... 1-1200</b> <b>DAE-3D.P2</b></p>      <p><b>DAE-5.P</b></p>	<p><b>DAIHATSU</b></p>  <p><b>D 0001-2000</b> <b>DAI-1.P</b> BERTONE-DAIHATSU</p>  <p><b>K... 1-8366</b> <b>DAI-2D</b></p>
---	---

Copyright by  
Alejandro Altuna S.A.  
2005

**JMA**

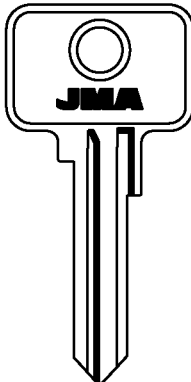

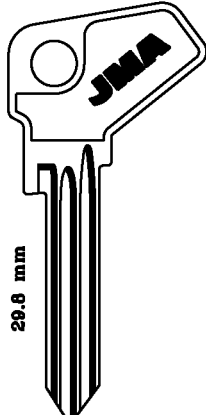
**132**

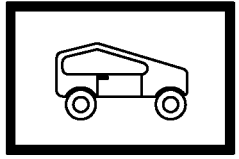
PARA: FOR:	DARMIX	DAV	DOBLINA	<b>PARA-FOR:</b>
	  <p>DAR-1</p>	     <p>6.1 1.95 DAV-1</p> <p>6.1 1.95 DAV-1.P</p> <p>DAF-MACK-RENAULT SAVIEM</p>	 <p>DOB-1 DOB-1D</p> <p>.....6 10000-44031</p> <p>DOB-2 DOB-2D</p> <p>TRABANT-WARTBURG</p>	<b>DARMIX (F)</b> <b>DAV (F)</b> <b>DOBLINA (D)</b> <b>DOM (D)</b> <b>DUBOIS (F)</b> <b>ECHO (I)</b> <b>FAAB (I)</b> <b>FAB (CZ)</b>
<b>PARA: FOR:</b> DOBLINA	<b>DOM</b>  <p>10000-44031</p> <p>....26      ....25</p> <p>DOB-3 DOB-3D</p> <p>TRABANT-WARTBURG</p>   <p>EV....1-2840 GS....1-1000 FT....1-1000 CQ....301-400</p> <p>EV....1-2840      ....1-1000</p> <p>DOM-9      DOM-9D</p> <p>DOM-38D</p> <p>NOBO</p>  <p>FA-GZ 0001-3948</p> <p>DOM-14D</p>	<b>DUBOIS</b>  <p>A... 1-2-3</p> <p>DU-1</p> <p>FLAMBO-YVEL</p>		
<b>PARA: FOR:</b> ECHO	<b>FAAB</b>   <p>ECH-1</p>     <p>2 100-309</p> <p>FAB-1</p>   <p>4... 100-309</p> <p>FAB-2</p>	<b>FAB</b>  <p>29.8 mm</p> <p>SKO-1</p> <p>SKODA</p>	<p>Copyright by Alejandro Altuna S.A. 2005</p>   <p><b>133</b></p>	

**PARA-FOR:**

PARA:  
FOR:

**FAB**

**FAB (CZ)**

**FAICA (E)**

**FARMA (I)**

**FEMSA (E)**

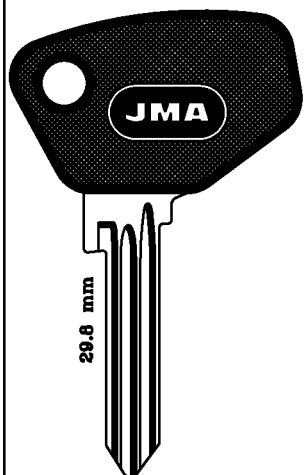

SKO-1.P  
SKODA

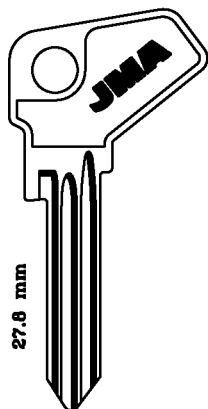

SKO-2  
SKODA

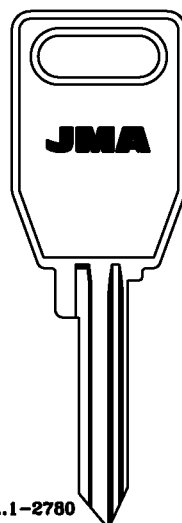

4AB...1-2780  
SKO-3I  
SKODA

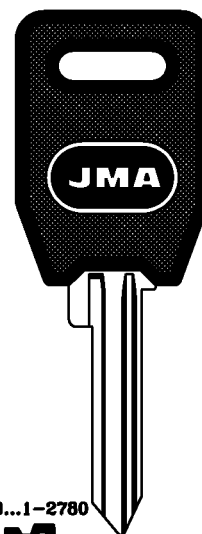

4AB...1-2780  
SKO-3I.P  
SKODA

PARA:  
FOR:

**FAB**

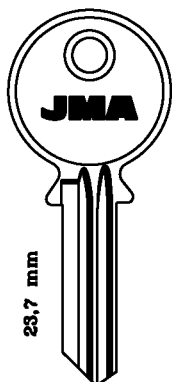

SKO-4  
SKODA

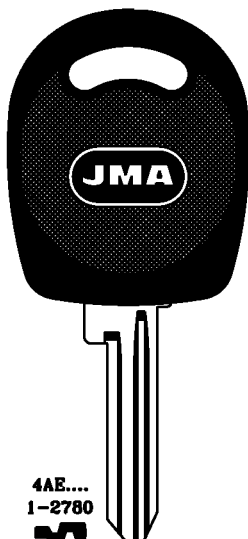

4AE...  
1-2780  
SKO-5.P  
SKODA

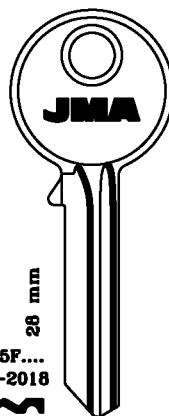

75F...  
1-2018  
SKO-6  
73F...  
74F...  
1-3120  
SKO-7  
SKODA

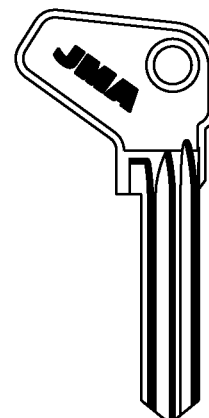

SKO-8

PARA:  
FOR:

**FAICA**

**FARMA**

**FEMSA**

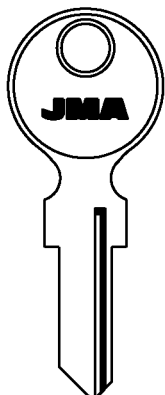

B  
FAI-B  
D  
FAI-D

A  
FAI-A  
C  
FAI-C

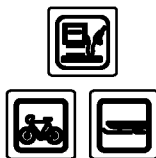
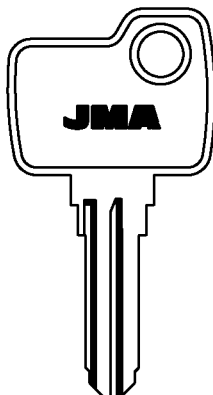

6 100-517 FAR-1I	8 100-517 FAR-1D
2 100-517 FAR-2I	4 100-517 FAR-2D
H 100-309 FAR-3	FAR-3D
	FAR-4D

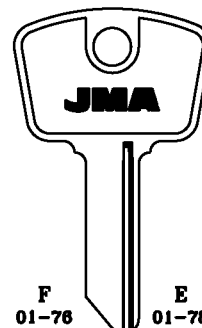

F 01-76 FEM-1I	E 01-78 FEM-1D
H 01-76 FEM-2I	G 01-78 FEM-2D
FEM-3I	FEM-3D

FISAM

Copyright by  
Alejandro Altuna S.A.  
2005

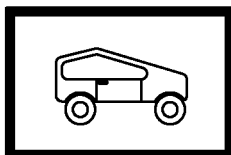

134

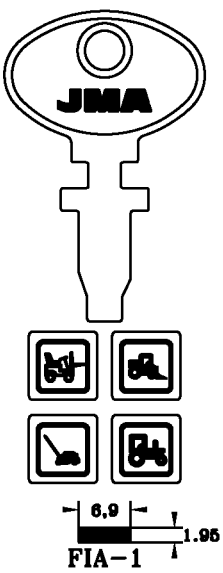
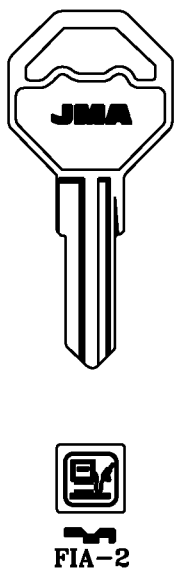
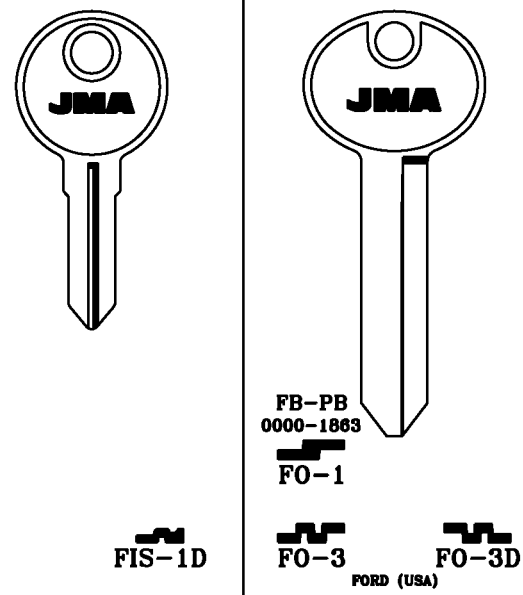
PARA: FOR:	FIAT	FIST	FORD
	 <p>FIA-1</p>	 <p>FIA-2</p>	 <p>FIS-1D</p> <p>FB-PB 0000-1863 FO-1</p> <p>FO-3 FORD (USA) FO-3D FORD (USA)</p>

**PARA-FOR:**

**FIAT (I)**

**FIST (I)**

**FORD (USA)**

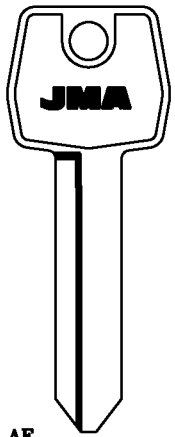
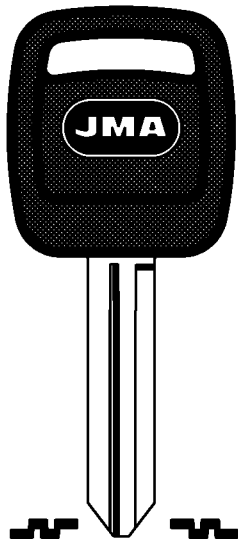
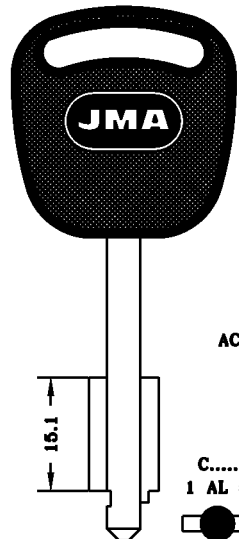
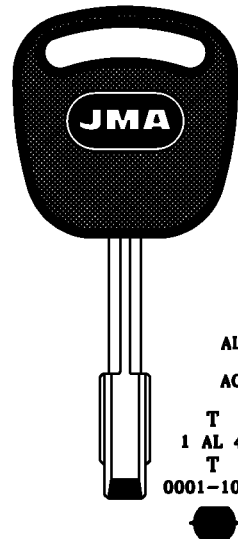
PARA: FOR:	FORD			
	 <p>AF 0001-2600 FA-PA 0000-1863 FO-2 FORD (USA)-MASERATI</p>	 <p>FO-3.P FORD (USA) FO-3D.P FORD (USA)</p>	 <p>ACE. 15.1 C..... 1 AL 5 FO-4.P FORD KOLB</p>	 <p>ALP. ACE. T 1 AL 4 T 0001-1050 FO-6.P FORD HUF</p>

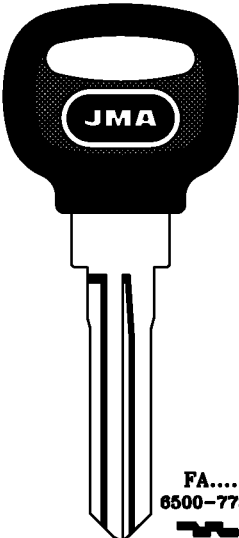
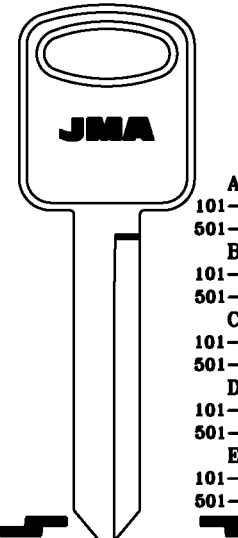
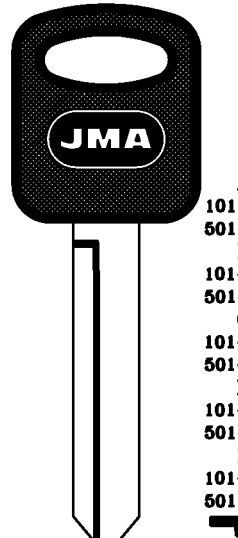
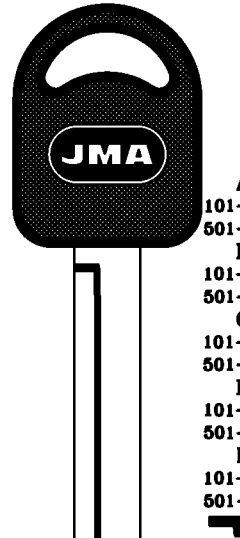
PARA: FOR:	FORD			
	 <p>FA.... 6500-7733 FO-7.P FORD</p>	 <p>A 101-291 501-579 B 101-332 501-602 C 101-344 501-624 D 101-327 501-602 E 101-296 501-579 FO-8 FORD</p>	 <p>A 101-291 501-579 B 101-332 501-602 C 101-344 501-624 D 101-327 501-602 E 101-296 501-579 FO-8D.P FORD</p>	 <p>A 101-291 501-579 B 101-332 501-602 C 101-344 501-624 D 101-327 501-602 E 101-296 501-579 FO-8D.P1 FORD-MERCURY</p>

Copyright by  
Alejandro Altuna S.A.  
2005

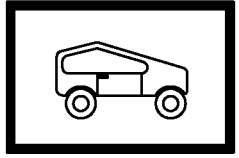

**PARA-FOR:**

**FORD (USA)**

**PARA:** FORD  
**FOR:**

10100-12099  
FO-9D  
FORD

10100-12099  
FO-9D.P  
FORD

X  
0001-8000  
FO-10.P  
FORD

A  
101-291  
501-579  
B  
101-332  
501-602  
C  
101-344  
501-624  
D  
101-327  
501-602  
E  
101-296  
501-579  
FA  
6500-7733  
FO-11D  
FORD

**PARA:** FORD  
**FOR:**

FO-12  
FORD

FO-12.P  
FORD

....  
10100-12099  
FO-13D.P  
FORD

FA....  
6500-7733  
FO-14D.P  
FORD

**PARA:** FORD  
**FOR:**

....X  
0001-1706  
FO-15D  
STRATTEC

....X  
0001-1706  
FO-15D.P  
STRATTEC

HV....  
1-8154  
1001-9282  
FO-17.P

FO-18D

Copyright by  
Alejandro Altuna S.A.  
2005

**JMA**

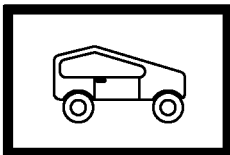

**136**

PARA:  
FOR:

FORD

PARA-FOR:

FORD (USA)

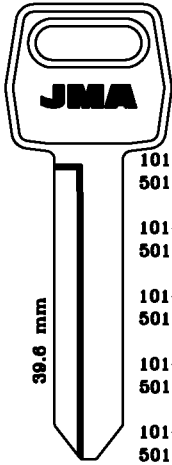

A  
101-291  
501-579  
B  
101-332  
501-602  
C  
101-344  
501-624  
D  
101-327  
501-602  
E  
101-296  
501-579  
FA  
8500-7733

39.6 mm

FO-20D  
FORD

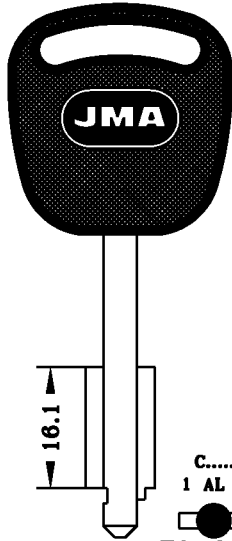

16.1

C.....  
1 AL 5

FO-22.P

FORD  
KOLB

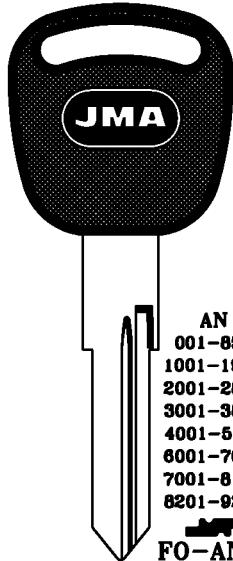

AN  
001-854  
1001-1918  
2001-2830  
3001-3690  
4001-5151  
6001-7088  
7001-8154  
8201-9282

FO-AN.P

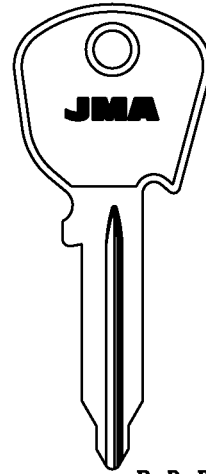

B-D-DV  
01-84

FO-D

FORD-JAGUAR-VOLKSWAGEN  
BRITAX-KOLB

PARA:  
FOR:

FORD

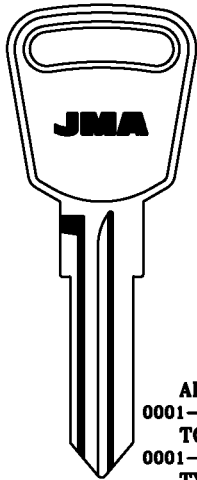

AK  
0001-1000  
TC  
0001-1000  
TX  
0001-1859

FO-E/TC

ASTON M.-FORD-JAGUAR-ROVER-YUGO  
CASI-CEM-CLAUSOR-KOLB-NEIMAN

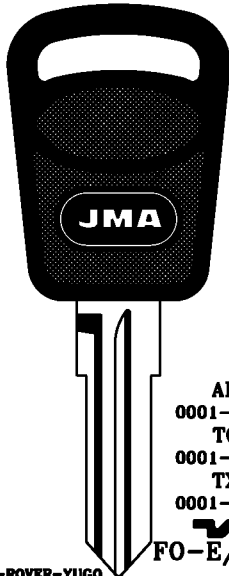

AK  
0001-1000  
TC  
0001-1000  
TX  
0001-1859

FO-E/TC.P

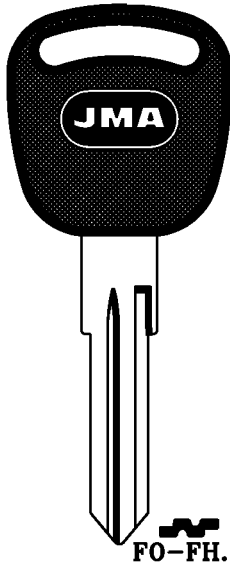

FO-FH.P

ASTON MARTIN  
AUTOBIANCHI  
DAIMLER  
FIAT  
JAGUAR  
JENSEN  
LOTUS  
PREMIER  
SEAT  
TRIUMPH  
YUGO ZASTAVA  
SCANIA  
FK  
1-3040

FO-FK

ARMAN-DOM-JUGODENT-WASO



FR  
1-3040  
4001-8000

FO-FR

PARA:  
FOR:

FORD

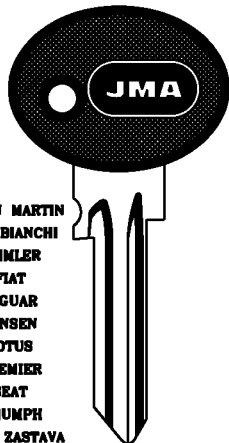

OL  
001-210  
07R  
001-195  
70R  
001-210  
FO-OL

CASI-YMOS

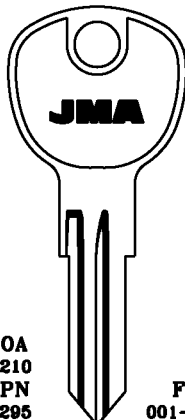

DA-OA  
001-210  
ER-PN  
101-295  
ER  
001-195  
ER  
101-695

FO-OA

DAF-EBRO-KENWORTH-VOLKSWAGEN  
CASI-HUF-YMOS

FB  
001-210  
PO  
501-695  
PO  
101-295

FO-PN

07L  
001-195  
70L  
001-210  
OR  
001-210  
FO-OR

OB...  
1-210

VO-7

NSU

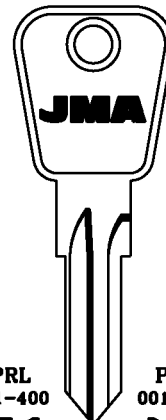

PRL  
001-400  
FO-PRL

XL  
001-195  
FO-XL

PRR  
001-400  
FO-PRR

XR  
001-195  
FO-XR

FORD  
CASI-YMOS

Copyright by  
Alejandro Altuna S.A.  
2005

JMA



137

**PARA-FOR:**

**FORD (USA)**

**GAS (RA)**

**G.M. (USA)**

**PARA:  
FOR:**

**FORD**

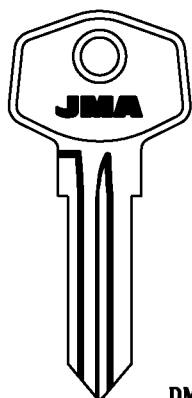

DM  
300-400  
TC-AK  
0001-1000  
TX  
0001-1859

**FO-TC**  
DAF-DAIMLER-FORD-JAGUAR  
CASI-CEM-KOLB

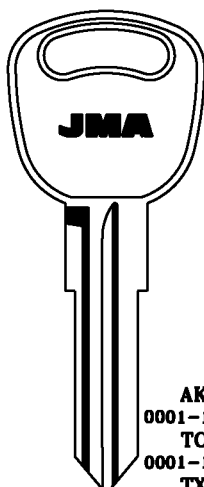

AK  
0001-1000  
TC  
0001-1000  
TX  
0001-1859

FORD

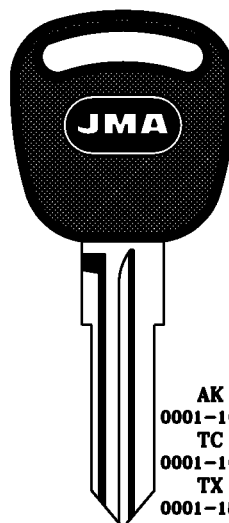

AK  
0001-1000  
TC  
0001-1000  
TX  
0001-1859

FORD

CASI-CEM-CLAUSOR-KOLB-NEIMAN

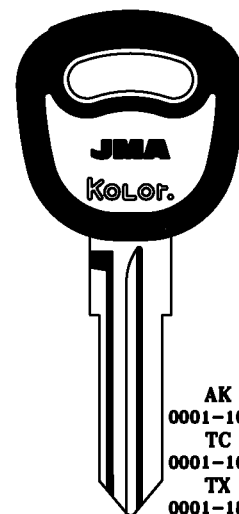

AK  
0001-1000  
TC  
0001-1000  
TX  
0001-1859

FORD

**FO-TXK.P**

**PARA:  
FOR:**

**FORD**

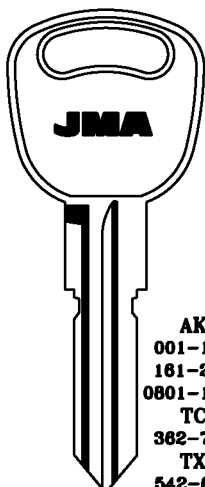

AK  
001-100  
181-250  
0801-1000  
TC  
382-728  
TX  
542-871  
1300-1801

FORD

**FO-TX1**  
CASI-CEM-CLAUSOR-KOLB-NEIMAN

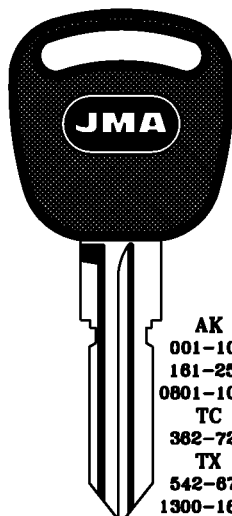

AK  
001-100  
181-250  
0801-1000  
TC  
382-728  
TX  
542-871  
1300-1801

FORD

**FO-TX1.P**

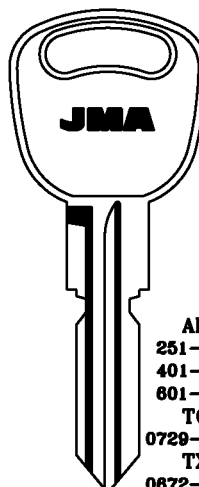

AK  
251-300  
401-500  
601-700  
TC  
0729-1000  
TX  
0872-1000  
1802-1859

FORD

**FO-TX2**  
CASI-CEM-CLAUSOR-KOLB-NEIMAN

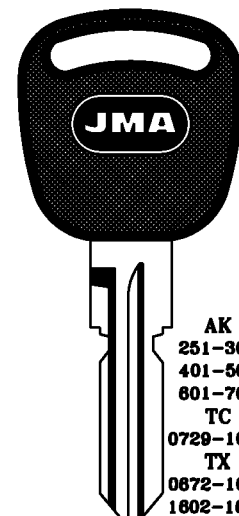

AK  
251-300  
401-500  
601-700  
TC  
0729-1000  
TX  
0872-1000  
1802-1859

FORD

**FO-TX2.P**

**PARA:  
FOR:**

**GAS**

**G.M.**

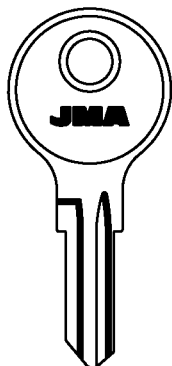

**GAS-1** **GAS-1D**

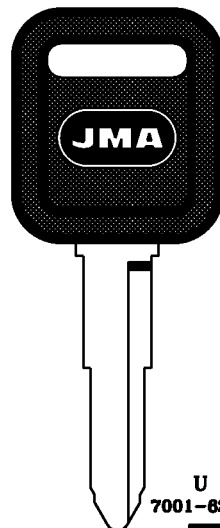

U  
7001-8200

**GM-1.P**  
G.M.  
BRIGGS STRATTON

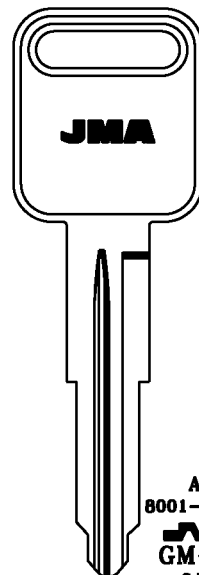

A  
8001-9400

**GM-2**  
G.M.  
BRIGGS STRATTON

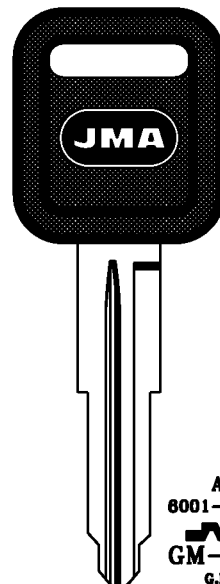

A  
8001-9400

**GM-2.P**  
G.M.  
BRIGGS STRATTON

Copyright by  
Alejandro Altuna S.A.  
2005

**JMA**

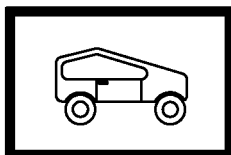

**138**

PARA:  
FOR:

G.M.

PARA-FOR:

G.M. (USA)

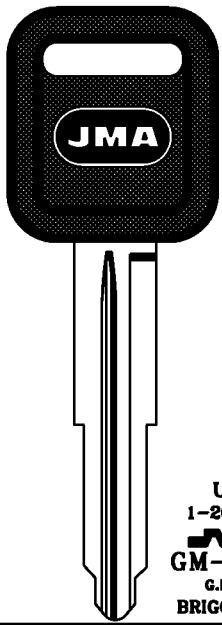

U  
1-2000  
GM-3.P  
G.M.  
BRIGGS S.

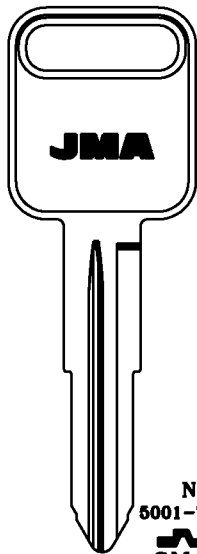

N  
5001-7000  
GM-4  
G.M.  
BRIGGS STRATTON

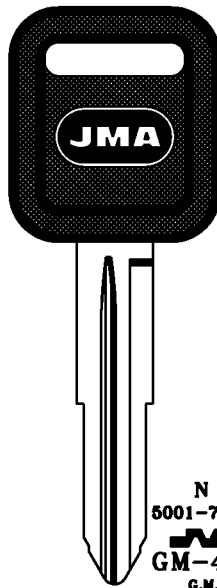

N  
5001-7000  
GM-4.P  
G.M.  
BRIGGS STRATTON

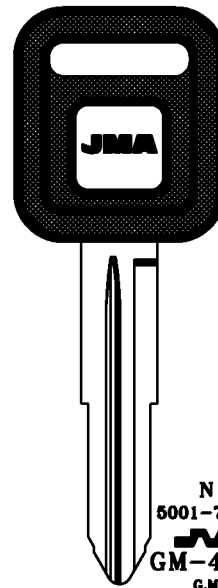

N  
5001-7000  
GM-4.P1  
G.M.  
BRIGGS STRATTON

PARA:  
FOR:

G.M.

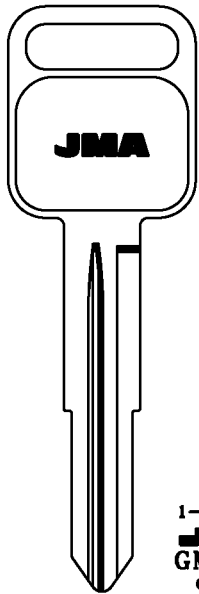

U  
1-2000  
GM-5  
G.M.  
BRIGGS S.

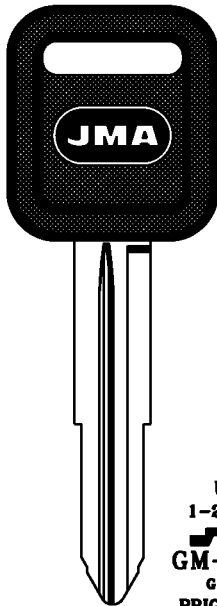

U  
1-2000  
GM-5.P  
G.M.  
BRIGGS S.

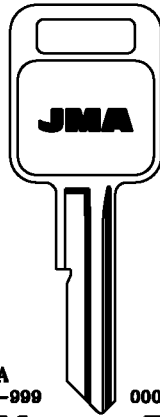

A  
000-999  
GM-6

E  
000-999  
GM-8

G.M.  
BRIGGS STRATTON

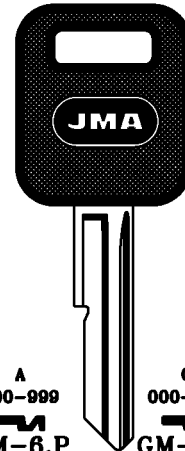

A  
000-999  
GM-6.P

E  
000-999  
GM-8.P

G.M.  
BRIGGS STRATTON

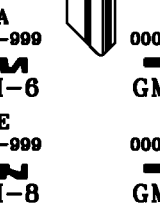

C  
000-999  
GM-7

J  
000-999  
GM-9

G.M.  
BRIGGS STRATTON

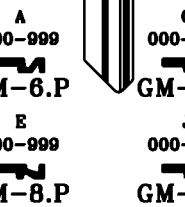

C  
000-999  
GM-7.P

J  
000-999  
GM-9.P

G.M.  
BRIGGS STRATTON

PARA:  
FOR:

G.M.

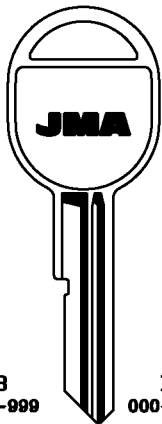

B  
000-999  
GM-10

H  
000-999  
GM-12

G.M.  
BRIGGS STRATTON

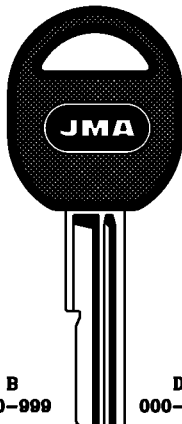

D  
000-999  
GM-10.P

H  
000-999  
GM-12.P

G.M.  
BRIGGS STRATTON

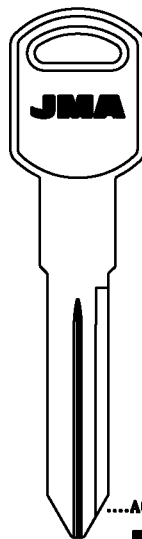

B  
000-999  
GM-11

K  
000-999  
GM-13

G.M.  
BRIGGS STRATTON

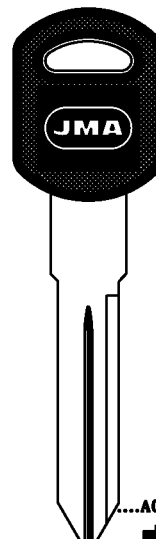

....A00-7N45  
GM-14

G.M.  
BRIGGS STRATTON

Copyright by  
Alejandro Altuna S.A.  
2005

JMA

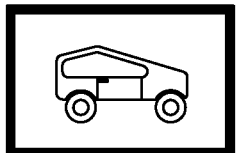

139

**PARA-FOR:**

**G.M. (USA)**

**PARA: FOR:** **G.M.**

**D....**  
4001-6000  
GM-15D  
ISUZU  
BRIGGS S.

**D....**  
4001-6000  
GM-15D.P  
ISUZU  
BRIGGS S.

LAT.

**A**  
..A.00.0-99.9  
..B.00.0-99.9  
..V.00.0-99.9  
..W.00.0-99.9  
..W.00.0-99.9

**C**  
..A.00.0-99.9  
..B.00.0-99.9  
..N.00.0-99.9  
..N.00.0-99.9  
..P.00.0-99.9  
..P.00.0-99.9

GM-16.P  
GM-17.P

**E**  
..J.00.0-99.9  
..K.00.0-99.9

GM-18.P  
G.M.  
BRIGGS STRATTON

**PARA: FOR:** **G.M.**

LAT.

**C**  
..A.00.0-99.9  
..B.00.0-99.9  
..N.00.0-99.9  
..N.00.0-99.9

**E**  
..P.00.0-99.9  
..P.00.0-99.9  
..J.00.0-99.9  
..K.00.0-99.9

GM-19.P  
G.M.  
BRIGGS STRATTON

GM-20.P  
G.M.  
BRIGGS & STRATTON

R...0-999  
T...0-394  
GM-21  
GM  
BRIGGS & STRATTON

R...0-999  
T...0-394  
GM-21.P  
GM  
BRIGGS & STRATTON

**PARA: FOR:** **G.M.**

LAT.

LAT.

LAT.

LAT.

..J.00.0-99.9  
..K.00.0-99.9  
GM-22  
GM-23  
G.M.  
BRIGGS STRATTON

..J.00.0-99.9  
..K.00.0-99.9  
GM-22.P  
GM-23.P  
G.M.  
BRIGGS STRATTON

1....  
1-5000  
GM-24  
GM-TOYOTA  
TOKAJ-RIKA

1....  
1-5000  
GM-24.P  
GM-TOYOTA  
TOKAJ-RIKA

Copyright by  
Alejandro Altuna S.A.  
2005

**JMA**

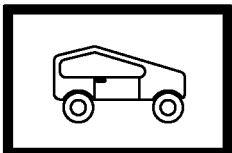

**140**

PARA:  
FOR:

G.M.

PARA-FOR:

G.M. (USA)

GHE (D)

GIOBERT (I)

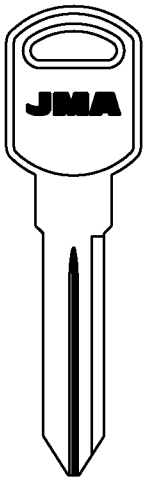

....A00-7N45  
GM-25

G.M.  
BRIGGS STRATTON

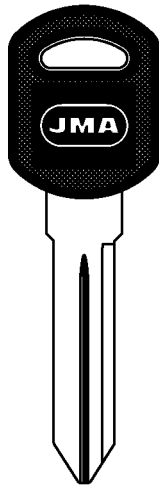

....A00-7N45  
GM-25.P

G.M.  
BRIGGS STRATTON



GM-26

LAT.

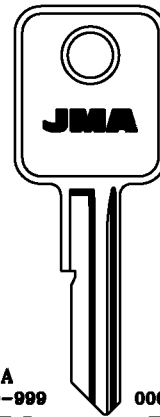

A	C
000-999	000-999
GM-A	GM-C
E	J
000-999	000-999
GM-E	GM-J

G.M.  
BRIGGS STRATTON

PARA:  
FOR:

G.M.

GHE

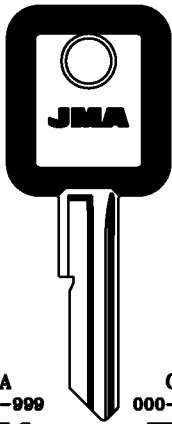

A	C
000-999	000-999
GM-A.P	GM-C.P
E	J
000-999	000-999
GM-E.P	GM-J.P

G.M.  
BRIGGS STRATTON

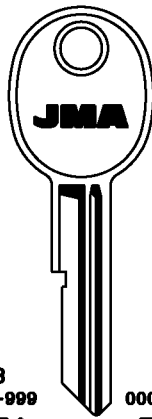

B	D
000-999	000-999
GM-B	GM-D
H	K
000-999	000-999
GM-H	GM-K

G.M.  
BRIGGS STRATTON

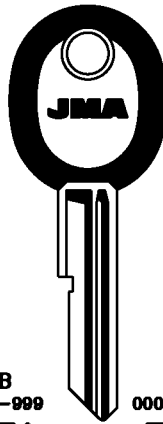

B	D
000-999	000-999
GM-B.P	GM-D.P
H	K
000-999	000-999
GM-H.P	GM-K.P

G.M.  
BRIGGS STRATTON

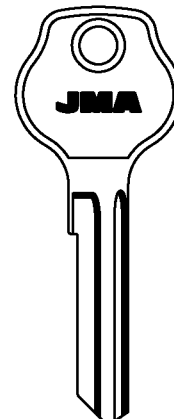

GH-1

PARA:  
FOR:

GHE

GIOBERT

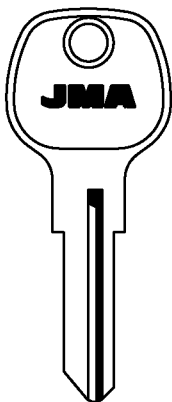

GX	HX
091-320	091-320
GH-GX	GH-HX

PEROHAUS-WECO

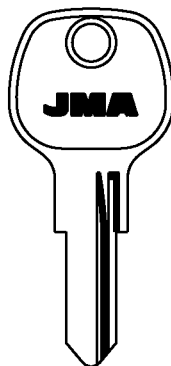

PS  
139  
GH-PS

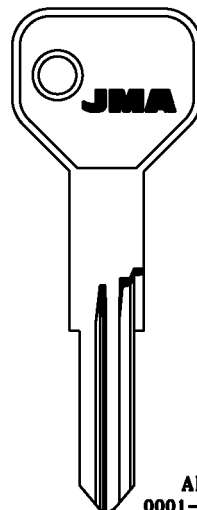

AL  
0001-1274  
AF-13  
ALFA ROMEO  
YMOS

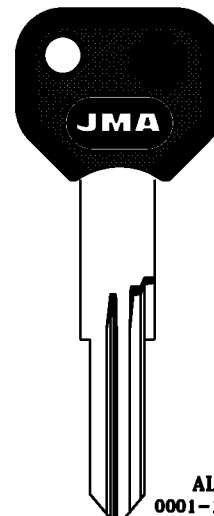

AL  
0001-1274  
AF-13.P  
ALFA ROMEO  
YMOS

Copyright by  
Alejandro Altuna S.A.  
2005

JMA



141

**PARA-FOR:**

**GIOBERT (I)**

**PARA: FOR:** **GIOBERT**

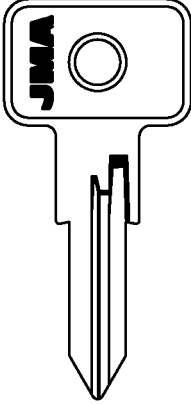
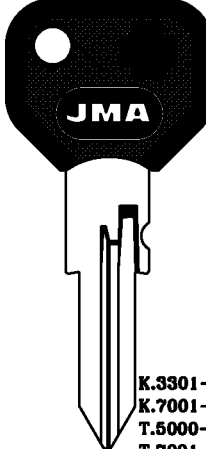
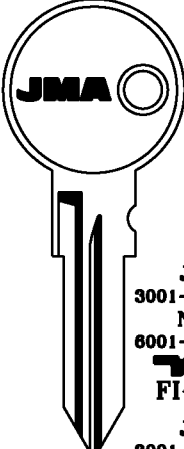
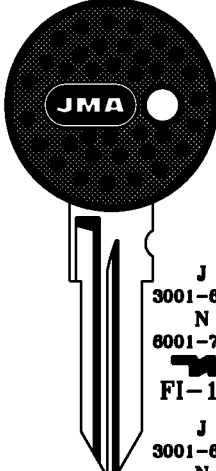
 K-H 7001-8092 AF-14	 K-H 7001-8092 AF-14.P	 J 3001-8732 N 8001-7000 FI-1 J 3001-8732 N 8001-7000 FI-10	 J 3001-8732 N 8001-7000 FI-1.P J 3001-8732 N 8001-7000 FI-10.P
K.3301-4866 K.7001-8092 T.5000-8027 T.7001-8092 S.0501-3278 H.7001-8092 FI-6I.P4		AUTOBIANCHI-FIAT-LANCIA RAYTON FISSORE-STREYR PUCH CAGIVA-GILERA-PIAGGIO VESPA	

**PARA: FOR:** **GIOBERT**

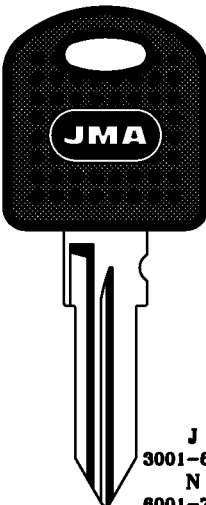
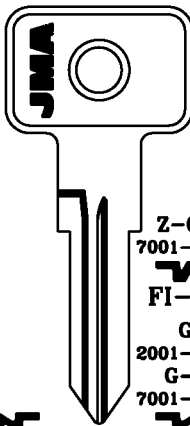
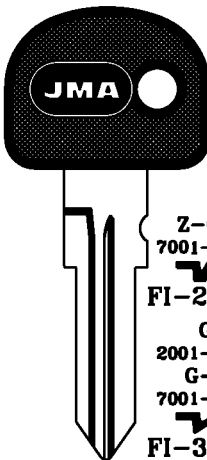
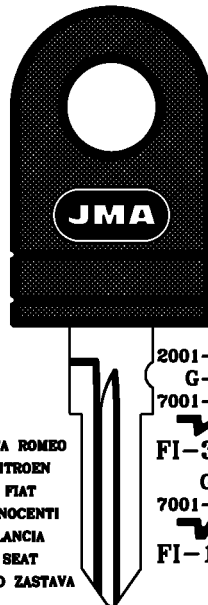
 J 3001-8732 N 8001-7000 FI-1.P8	 Z-GR 7001-9956 FI-2D G 2001-4530 G-Z 7001-9956 FI-3D G 7001-9956 FI-12	 Z-GR 7001-9956 FI-2D.P3 G 2001-4530 G-Z 7001-9956 FI-3D.P3 G 7001-9956 FI-12.P3	 G 2001-4530 G-Z 7001-9956 FI-3D.P ALFA ROMEO CITROEN FIAT INNOCENTI LANCIA SEAT YUGO ZASTAVA G 7001-9956 FI-12.P
A. ROMEO-AUTOBIANCHI-CITROEN-FIAT INNOCENTI-LANCIA-PEUGEOT-SEAT YUGO ZASTAVA-FIAT IVECO		A. ROMEO-AUTOBIANCHI-CITROEN-FIAT LANCIA-PEUGEOT-SEAT	

**PARA: FOR:** **GIOBERT**

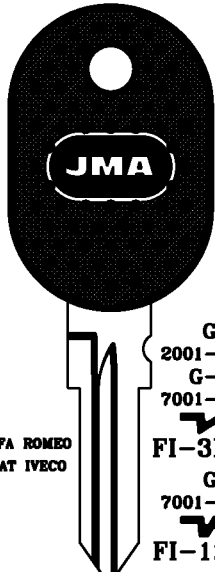
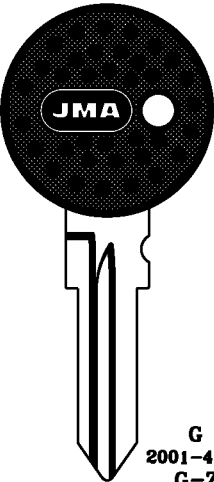
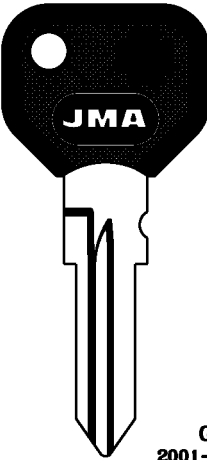
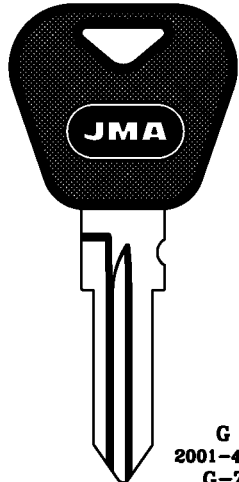
 G 2001-4530 G-Z 7001-9956 FI-3D.P1 G 7001-9956 FI-12.P1 ALFA ROMEO FIAT IVECO	 G 2001-4530 G-Z 7001-9956 FI-3D.P2 FIAT	 G 2001-4530 G-Z 7001-9956 FI-3D.P4 ALFA ROMEO	 G 2001-4530 G-Z 7001-9956 FI-3D.P5 INNOCENTI-YUGO ZASTAVA
---	---	--	---

Copyright by  
Alejandro Altuna S.A.  
2005

**JMA**

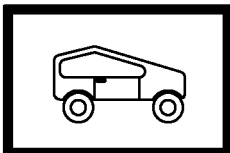

PARA:  
FOR:

# GIOBERT

PARA-FOR:

## GIOBERT (I)

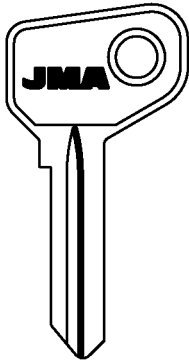

FI-4D

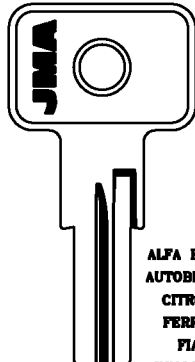

FI-6I

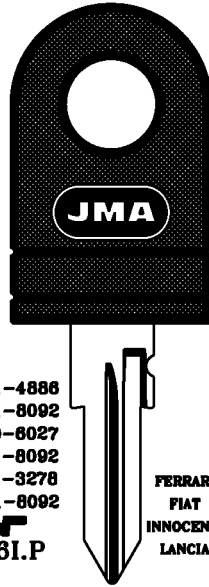

FI-6I.P

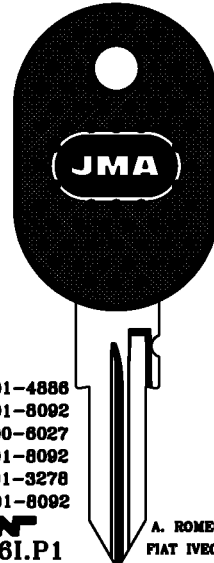

FI-6I.P1

K 3301-4886  
K 7001-8092  
T 5000-8027  
T 7001-8092  
S 0501-3278  
H 7001-8092

ALFA ROMEO  
AUTOBIANCHI  
CITROEN  
FERRARI  
FIAT  
INNOCENTI  
LANCIA  
PEUGEOT  
YUGO ZASTAVA  
CAGIVA  
DUCATI  
FANTIC MOTOR  
GARELLI  
GILERA

K 3301-4886  
K 7001-8092  
T 5000-8027  
T 7001-8092  
S 0501-3278  
H 7001-8092

FERRARI  
FIAT  
INNOCENTI  
LANCIA

K 3301-4886  
K 7001-8092  
T 5000-8027  
T 7001-8092  
S 0501-3278  
H 7001-8092

A. ROMEO  
FIAT IVECO

FI-5I  
FI-5D  
OM IVECO-FIAT IVECO  
IACAM

PARA:  
FOR:

# GIOBERT

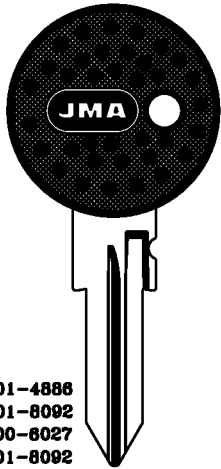

K 3301-4886  
K 7001-8092  
T 5000-8027  
T 7001-8092  
S 0501-3278  
H 7001-8092

FI-6I.P2

FERRARI  
FIAT  
CAGIVA

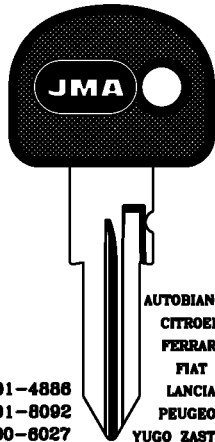

K 3301-4886  
K 7001-8092  
T 5000-8027  
T 7001-8092  
S 0501-3278  
H 7001-8092

FI-6I.P3

AUTOBIANCHI  
CITROEN  
FERRARI  
FIAT  
LANCIA  
PEUGEOT  
YUGO ZASTAVA  
CAGIVA  
DUCATI  
FANTIC MOTOR  
GARELLI  
GILERA

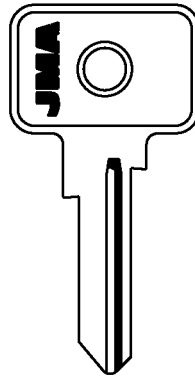

X  
3301-4886

FI-7I

FIAT  
NEIMAN-SIPEA

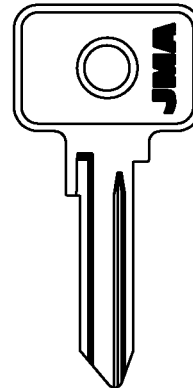

Y  
7001-9956

FI-8I

AUTOBIANCHI-FIAT-SEAT  
ARMAN

PARA:  
FOR:

# GIOBERT

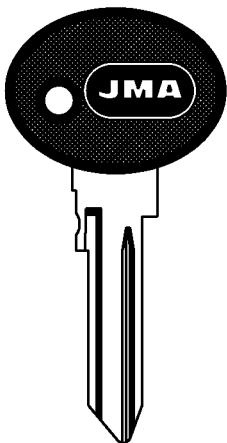

Y  
7001-9956

FI-8I.P

AUTOBIANCHI-FIAT-SEAT  
ARMAN

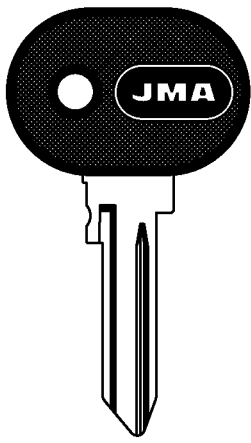

Y  
7001-9956

FI-8I.P1

FIAT-FIAT IVECO  
ARMAN



M  
0001-1050

FI-9I

ALFA ROMEO-AUTOBIANCHI-FIAT-LANCIA  
OM IVECO-SEAT-STEYR PUCH

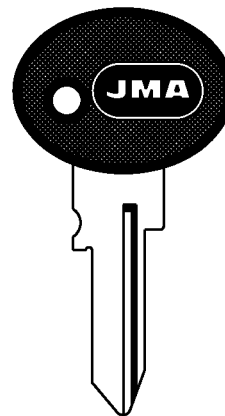

M  
0001-1050

FI-9I.P

Copyright by  
Alejandro Altuna S.A.  
2005

# JMA



# 143

**PARA-FOR:**

**GIOBERT (I)**

**PARA:  
FOR:**

**GIOBERT**

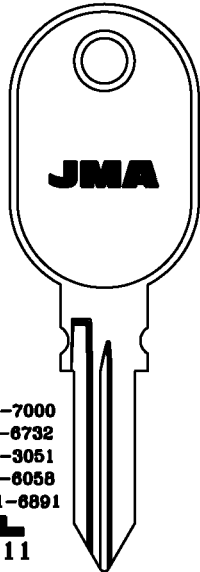

N 6001-7000  
J 3001-8732  
V 0001-3051  
V 5001-8058  
AB 6001-6891  
  
FI-11

AUTOBIANCHI-FIAT-INNOCENTI-LANCIA  
RAYTON FISSORE-STEYR PUCH-APRILIA

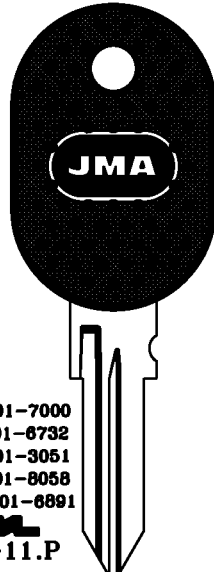

N 6001-7000  
J 3001-8732  
V 0001-3051  
V 5001-8058  
AB 6001-6891  
  
FI-11.P

AUTOBIANCHI-FIAT-INNOCENTI-LANCIA  
RAYTON FISSORE-STEYR PUCH-APRILIA

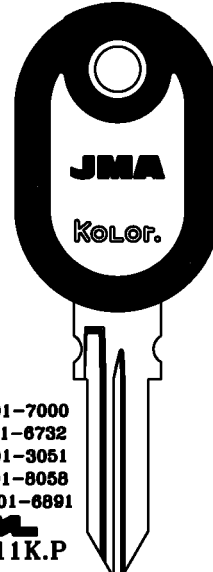

N 6001-7000  
J 3001-8732  
V 0001-3051  
V 5001-8058  
AB 6001-6891  
  
FI-11K.P

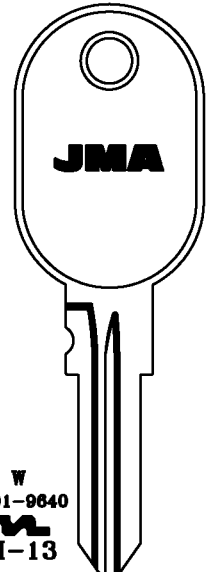

W  
0001-9640  
  
FI-13

ALFA ROMEO-FIAT-LANCIA

**PARA:  
FOR:**

**GIOBERT**

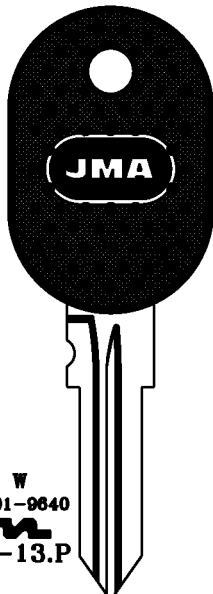

W  
0001-9640  
  
FI-13.P

ALFA ROMEO-FIAT-LANCIA

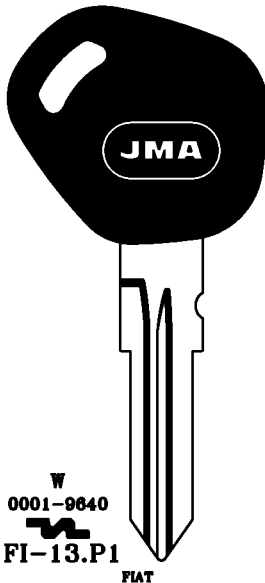

W  
0001-9640  
  
FI-13.P1

FIAT

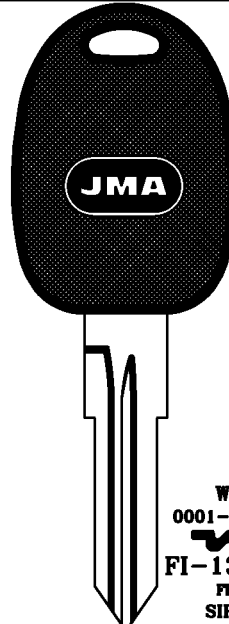

W  
0001-9640  
  
FI-13.P7

FIAT

SIPEA

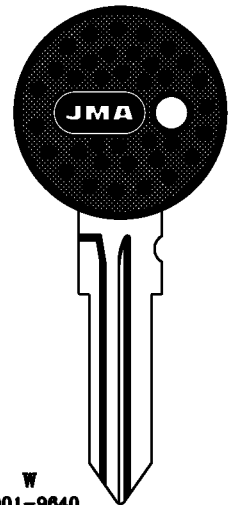

W  
0001-9640  
  
FI-14.P

ALFA ROMEO-FIAT-LANCIA

**PARA:  
FOR:**

**GIOBERT**

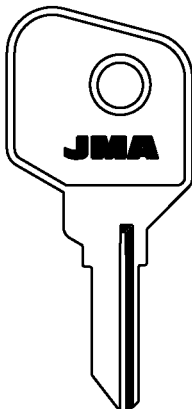

FI-15

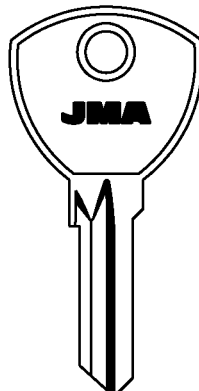

GIOB-21  
LANCIA-MASERATI

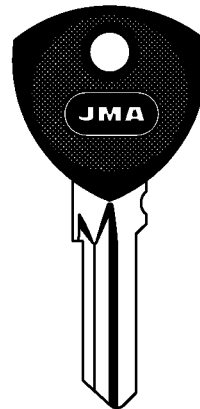

GIOB-1D.P  
LANCIA-MASERATI

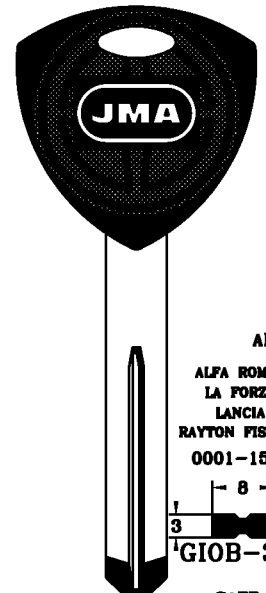



ALP.  
ALFA ROMEO  
LA FORZA  
LANCIA  
RAYTON FISSORE  
0001-1530  
  
GIOB-3.P  
SAFE

Copyright by  
Alejandro Altuna S.A.  
2005

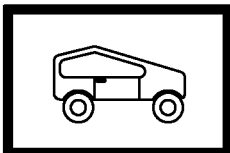
**JMA**

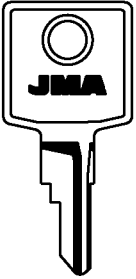
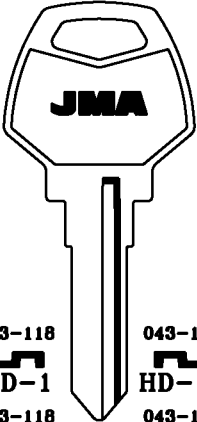
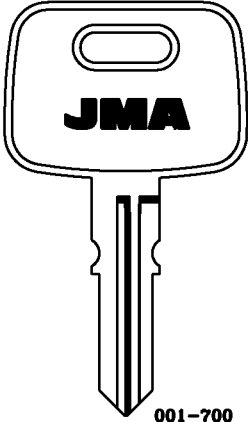
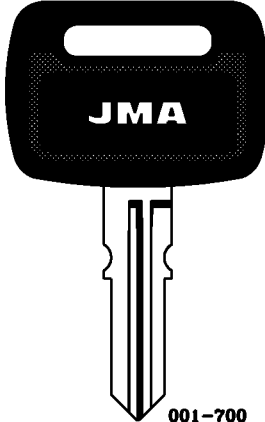

**144**

<b>PARA: FOR:</b> HAMA	<b>HARLEY DAV.</b>	<b>HONDA</b>	
			
	043-118 HD-1 043-118 HD-2 043-118 HD-3	043-118 HD-1D 043-118 HD-2D 043-118 HD-3D	001-700 HOND-1 001-700 HOND-2
751-782 HA-1I 778-789 HA-1D FORD BLAU	HARLEY DAVIDSON	HONDA-TRIUMPH	HONDA-TRIUMPH 001-700 HOND-1.P 001-700 HOND-2.P

**PARA-FOR:**  
**HAMA (D)**  
**HARLEY DAV. (USA)**  
**HONDA (J)**

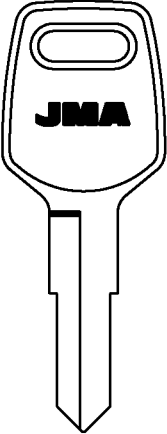
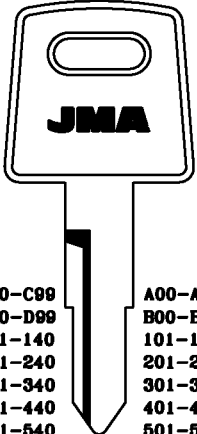
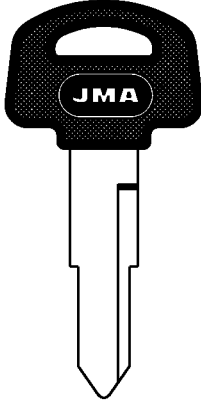
<b>PARA: FOR:</b>	<b>HONDA</b>		
			
1 AL 4 HOND-3I HONDA	C00-C99 D00-D99 121-140 221-240 321-340 421-440 521-540 621-640 721-740 821-640	A00-A99 B00-B99 101-120 201-220 301-320 401-420 501-520 601-620 701-720 801-820	A00-A99 B00-B99 101-120 201-220 301-320 401-420 501-520 601-620 701-720 801-820 HOND-4D.P2
HOND-3I HOND-3D HONDA	HOND-4I HOND-4D HONDA	HOND-25.P2 HOND-30.P2 HONDA	HOND-30D.P2 HONDA

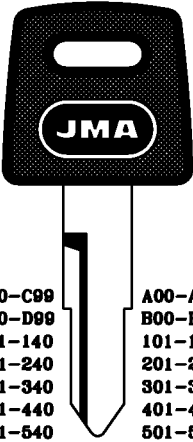
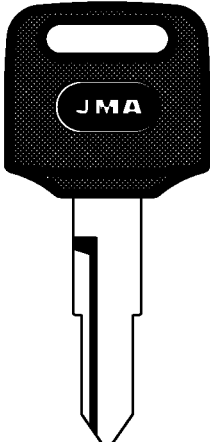
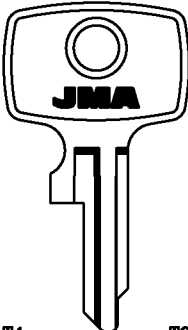
<b>PARA: FOR:</b>	<b>HONDA</b>		
			
C00-C99 D00-D99 121-140 221-240 321-340 421-440 521-540 621-640 721-740 821-640	A00-A99 B00-B99 101-120 201-220 301-320 401-420 501-520 601-620 701-720 801-820	...C00-C99 ...D00-D99 HOND-4I.P1 HOND-18.P HONDA	...A00-A99 ...B00-B99 HOND-4D.P1 HOND-18D.P HONDA
HOND-4I.P HOND-4D.P HONDA	HOND-5I HOND-6I HOND-7I HONDA	HOND-5D HOND-6D HOND-7D HONDA	T4 T9 T1 T8 T3 T8

Copyright by  
Alejandro Altuna S.A.  
2005

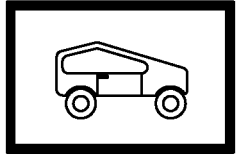

ATENCION:Concerniente a las marcas y denominaciones comerciales ver nota en indice.ATTENTION:Concerning the marks and commercial denominations see note in index. ATTENTION:Concernant les marques et denominations commerciales voir la note dans l'index.ACHTUNG:Beziehen auf die marke und handelsname sehen sie die notiz im index.

**PARA-FOR:**

**HONDA (J)**

**PARA:  
FOR:**

**HONDA**

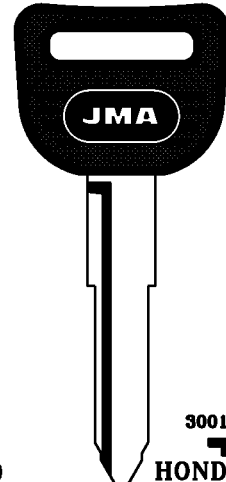
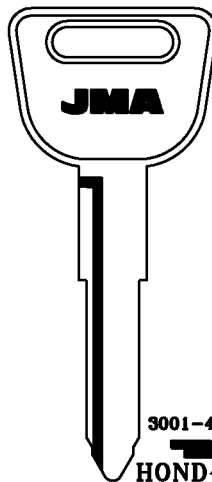
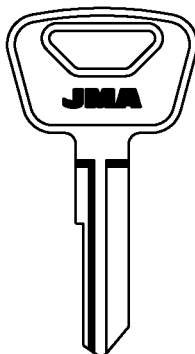
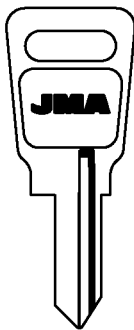

HOND-8I HOND-8D HOND-9I HOND-9D  
HONDA HONDA

3001-4481  
HOND-10  
3001-4481  
HOND-11  
ACURA-HONDA-ROVER

3001-4481  
HOND-10.P  
3001-4481  
HOND-11.P  
ACURA-HONDA-ROVER

**PARA:  
FOR:**

**HONDA**

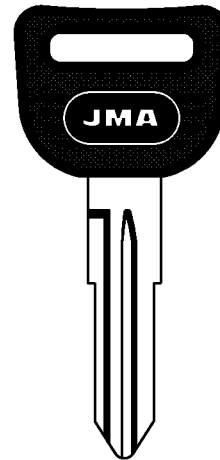
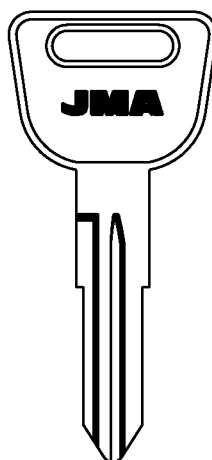
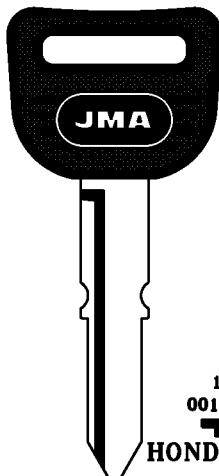
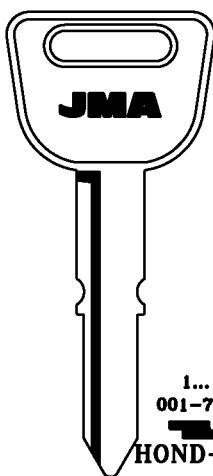

1...  
001-700  
HOND-12  
2...  
001-700  
HOND-13  
HONDA

1...  
001-700  
HOND-12.P  
2...  
001-700  
HOND-13.P  
HONDA

5001-8442  
HOND-14  
HONDA

5001-8442  
HOND-14.P  
HONDA

**PARA:  
FOR:**

**HONDA**

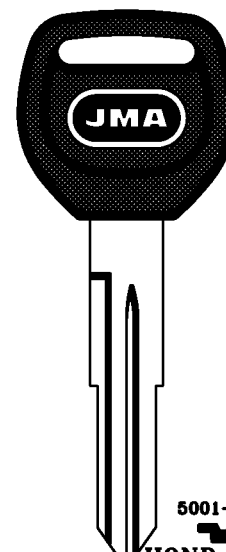
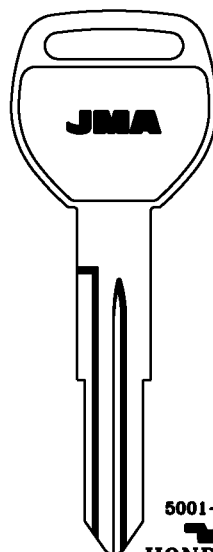
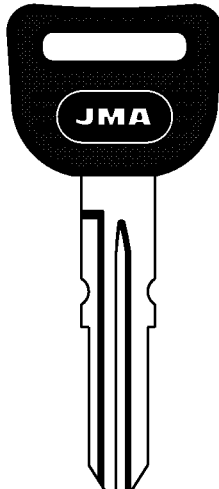
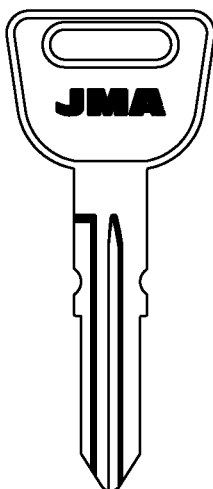

5001-8442  
HOND-15  
ACURA-HONDA

5001-8442  
HOND-15.P  
ACURA-HONDA

5001-8442  
HOND-16D  
ACURA-HONDA

5001-8442  
HOND-16D.P  
ACURA-HONDA

Copyright by  
Alejandro Altuna S.A.  
2005

**JMA**

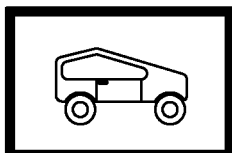

**146**

ATENCION:Concerniente a las marcas y denominaciones comerciales ver nota en indice.ATTENTION:Concerning the marks and commercial denominations see note in Index.  
ATTENTION:Concernant les marques et denominations commerciales voir la note dans l'index.ACHTUNG:Beziehen auf die marke und handelsname sehen sie die notiz im Index.

PARA:  
FOR:

### HONDA

PARA-FOR:

### HONDA (J)

5001-8442  
HOND-16D.P1  
ACURA-HONDA

ALP.  
9  
3,5  
HOND-17.P  
ACURA

...A00-A99  
...B00-B99  
HOND-19  
HONDA

...C00-C99  
...D00-D99  
HOND-19D  
HONDA

...A00-A99  
...B00-B99  
HOND-19.P  
HONDA

...C00-C99  
...D00-D99  
HOND-19D.P  
HONDA

PARA:  
FOR:

### HONDA

.....1 AL 3  
HOND-20  
HONDA

.....1 AL 3  
HOND-20D  
HONDA

...  
30B-34A  
H...0-7-8-9  
HOND-21

HOND-20.P  
HONDA

HOND-20D.P  
HONDA

HOND-22D.P  
HONDA

PARA:  
FOR:

### HONDA

HOND-23

HOND-24.P

HOND-26.P1

HOND-27D

Copyright by  
Alejandro Altuna S.A.  
2005

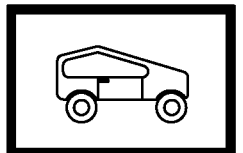

**PARA-FOR:**

PARA:  
FOR:

HONDA

HUDSON

HONDA (J)

HUDSON (USA)

HUF (D)

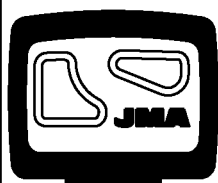

.....1 AL 3  
HOND-28.P

HOND-28D.P  
HONDA



HOND-29.P

HOND-29D.P

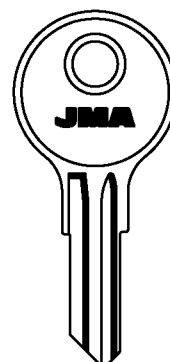

A....201-1050  
C...500-899  
H....601-1100  
HM...201-1050



HUD-1 HUD-1D

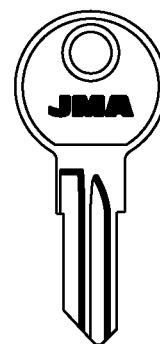

HUD-2D

PARA:  
FOR:

HUF

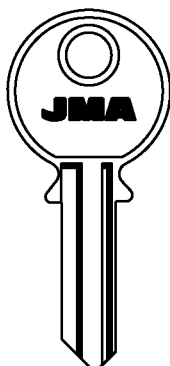

48-I 48-D

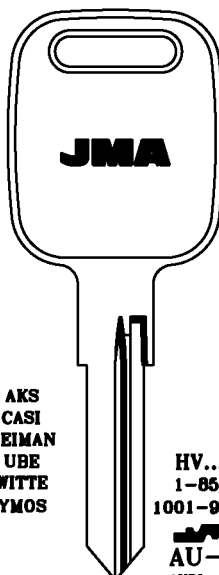

AKS  
CASI  
NEIMAN  
UBE  
WITTE  
YMOS

HV....  
1-854  
1001-9282

AU-1  
AUDI  
VOLKSWAGEN-SCANIA

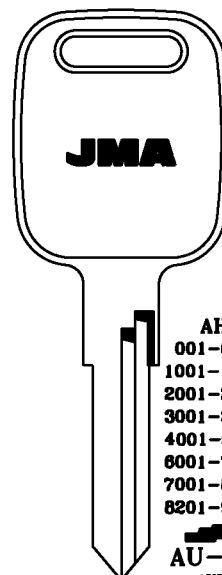

AH  
001-854  
1001-1918  
2001-2830  
3001-3890  
4001-5151  
6001-7088  
7001-8154  
8201-9282

AU-AH  
AUDI

AKS-CASI-UBE-WITTE

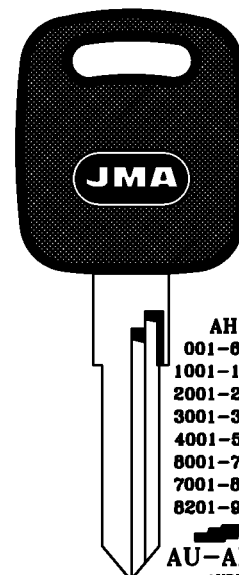

AH  
001-854  
1001-1918  
2001-2830  
3001-3890  
4001-5151  
6001-7088  
7001-8154  
8201-9282

AU-AH.P  
AUDI

AKS-CASI-UBE-WITTE

PARA:  
FOR:

HUF

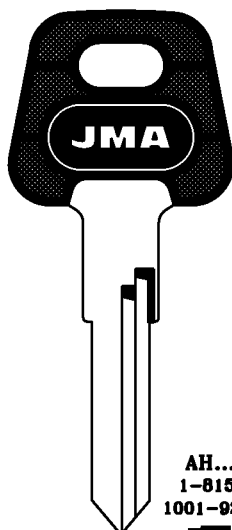

AH....  
1-8154  
1001-9282

AU-AH.P1  
AUDI  
WITTE

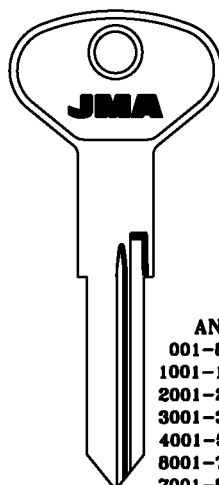

AN  
001-854  
1001-1918  
2001-2830  
3001-3890  
4001-5151  
6001-7088  
7001-8154  
8201-9282

AU-AN

AUDI-VOLKSWAGEN  
AKS-CASI-UBE-WITTE

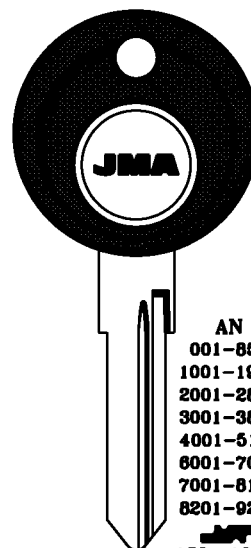

AN  
001-854  
1001-1918  
2001-2830  
3001-3890  
4001-5151  
6001-7088  
7001-8154  
8201-9282

AU-AN.P

AUDI-FORD-PORSCHE-VOLKSWAGEN  
AKS-CASI-UBE-WITTE

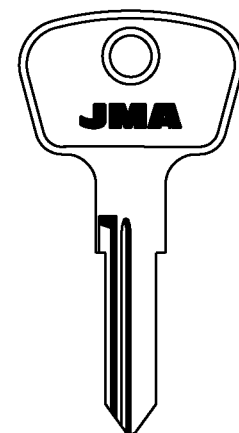

C  
01-32/01-82

AU-C  
AUDI  
AKS

Copyright by  
Alejandro Altuna S.A.  
2005

JMA

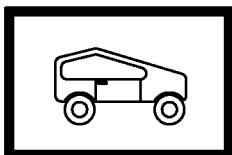

148

PARA:  
FOR:

### HUF

PARA-FOR:

### HUF (D)

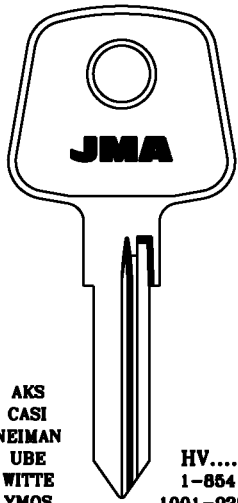

AKS  
CASI  
NEIMAN  
UBE  
WITTE  
YMOS

HV...  
1-854  
1001-9282



AU-HV  
AUDI-VOLKSWAGEN-SCANIA

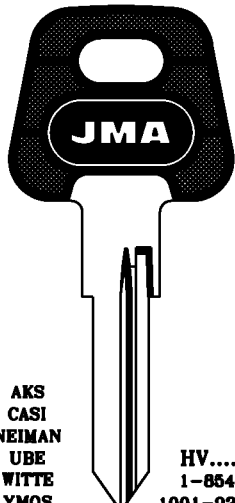

AKS  
CASI  
NEIMAN  
UBE  
WITTE  
YMOS

HV...  
1-854  
1001-9282



AU-HV.P  
AUDI-VOLKSWAGEN-SCANIA

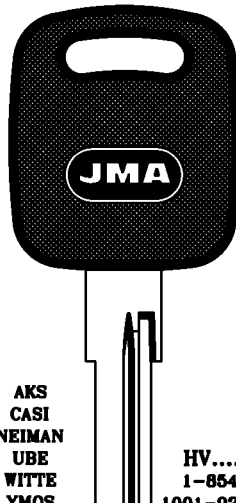

AKS  
CASI  
NEIMAN  
UBE  
WITTE  
YMOS

HV...  
1-854  
1001-9282



AU-HV.P1  
AUDI

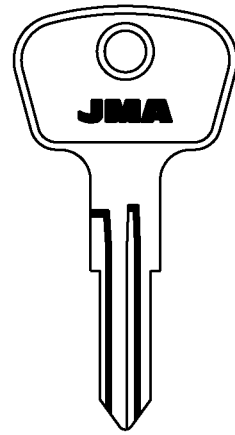

W  
11-91/11-91

AU-W  
AUDI-VOLKSWAGEN  
AKS-WITTE

PARA:  
FOR:

### HUF

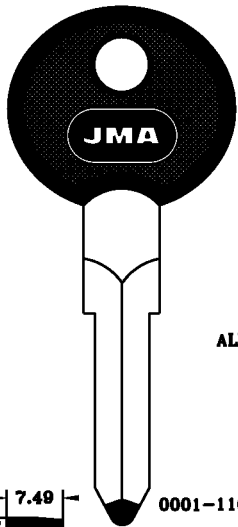

ALP.

7.49  
2.7  
BM-1.P

0001-1100

BMW  
PEBRA

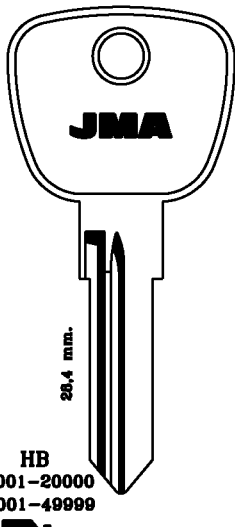

28.4 mm.

HB  
10001-20000  
40001-49999

BM-2

BMW

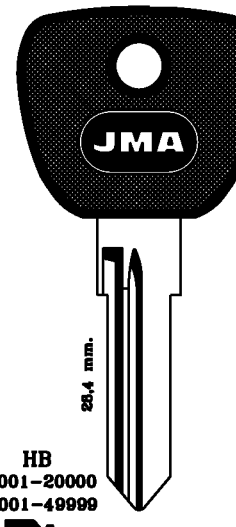

28.4 mm.

HB  
10001-20000  
40001-49999

BM-2.P

BMW

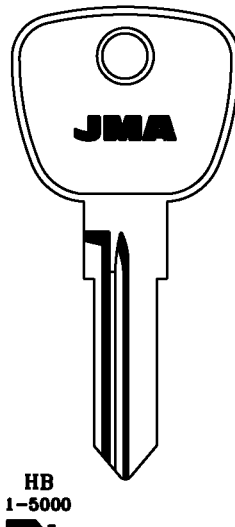

HB  
1-5000

BM-3

BMW

PARA:  
FOR:

### HUF

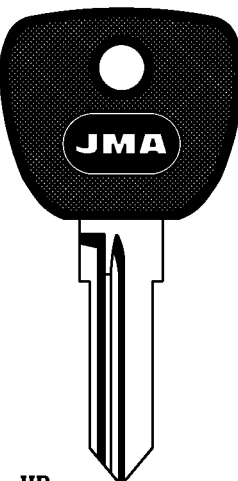

HB  
1-5000  
BM-3.P

BMW

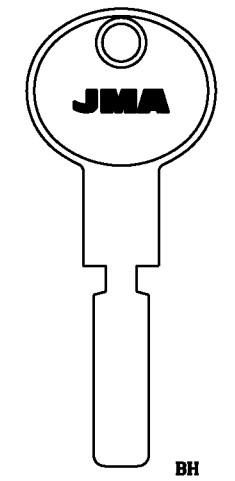

7.2  
3.5  
BM-4

BMW  
TIBBE

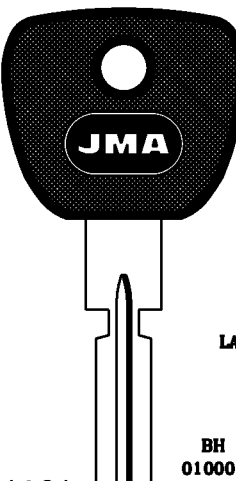

7.2  
3.5  
BM-5.P

BMW  
TIBBE

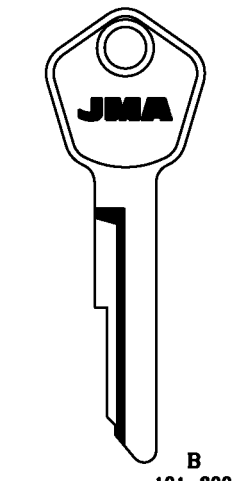

LAT.

BH  
010001  
241009

B  
101-300  
401-830

BM-B

BMW  
WITTE

Copyright by  
Alejandro Altuna S.A.  
2005

# JMA



**PARA-FOR:**

**HUF (D)**

**PARA: FOR:** **HUF**

26,6 mm. 26,6 mm. 26,6 mm. 26,6 mm.

HB 1-5000  BM-HB BMW	NB 1-5000  BM-NB BMW	HB 1-5000  BM-HB.P BMW	NB 1-5000  BM-NB.P BMW	H.....P 12353-53425  BM-HB.P1 NEIMAN	W 1001-2020 7001-8000  BM-W BMW
----------------------------------	----------------------------------	------------------------------------	------------------------------------	--	--

**PARA: FOR:** **HUF**

KST...1-240  
ST...1-240  
TST...1-240  
  
FO-SR  
FORD EUROPA

HU-1  
NEIMAN-WITTE-YMOS

ALP.  
HU-2.P  
SCANIA  
7,8  
3,5  
1-2000

AN  
001-854  
1001-1918  
2001-2830  
3001-3690  
4001-5151  
8001-7088  
7001-8154  
8201-9282  
  
HU-AN  
VOLKSWAGEN  
AKS-CASI-UBE-WITTE

**PARA: FOR:** **HUF**

DF-F  
0001-1975  
  
HU-DF  
VOLVO

DF-F  
0001-1975  
  
HU-DF.P  
VOLVO

DF-F  
0001-1975  
  
HU-DF.P1  
VOLVO

LAT.  
DN-DH  
8001-8000  
7,2  
3,45  
  
HU-DH.P  
VOLVO

Copyright by  
Alejandro Altuna S.A.  
2005

**JMA**

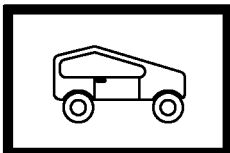

**150**

PARA:  
FOR:

HUF

PARA-FOR:

HUF (D)

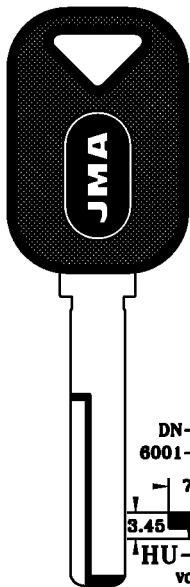

LAT.

DN-DH  
6001-6000



HU-DN.P  
VOLVO

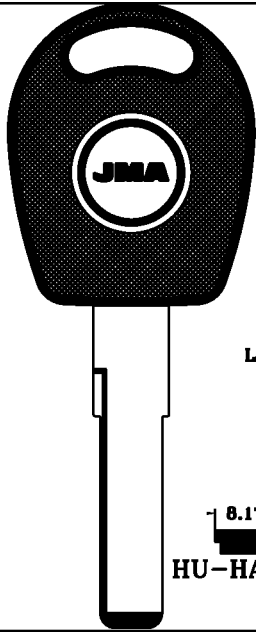

LAT.



HU-HAA.P1

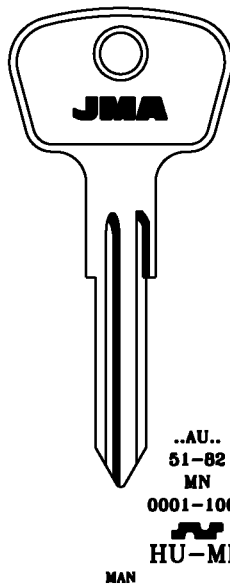

MAN

..AU..  
51-82  
MN  
0001-1000



HU-MN

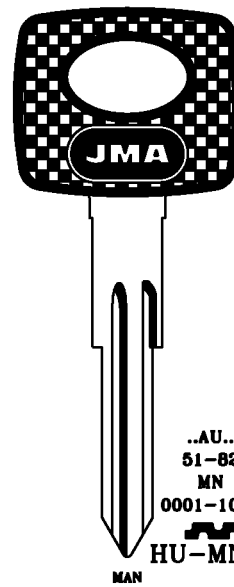

MAN

..AU..  
51-82  
MN  
0001-1000



HU-MN.P

PARA:  
FOR:

HUF



P  
001-252  
HU-P

VDO

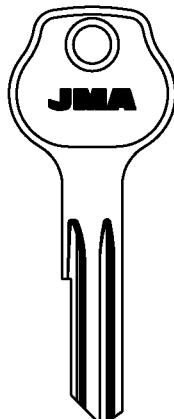

SE  
001-750  
SC  
401-630  
HU-SC

BMW-MAN-PORSCHE-STEYR PUCH-VOLKSWAGEN-SCANIA

SR  
001-240  
KSR  
001-240  
LSR  
001-240  
TSR  
001-240  
HU-SR



SZ  
1-240  
HU-SZ

AKS

SU  
001-240  
401-630  
HU-SU

SX  
001-240  
HU-SX

SY  
001-240  
HU-SY

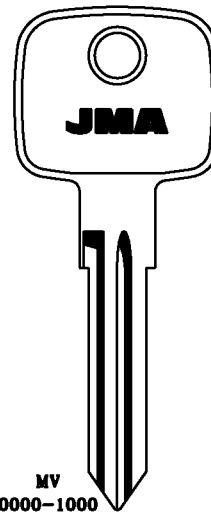

MV  
0000-1000  
ME-1

MERCEDES  
CLAUSOR

PARA:  
FOR:

HUF

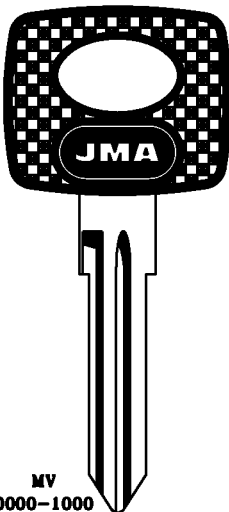

MV  
0000-1000  
ME-1.P

MERCEDES  
CLAUSOR

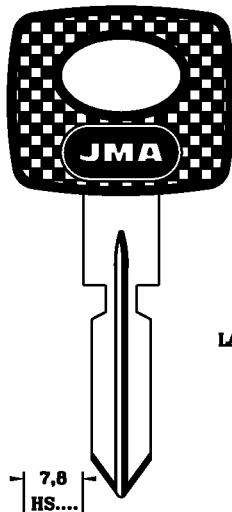

HS....  
7,8  
ME-2.P

MERCEDES  
YMOS

LAT.

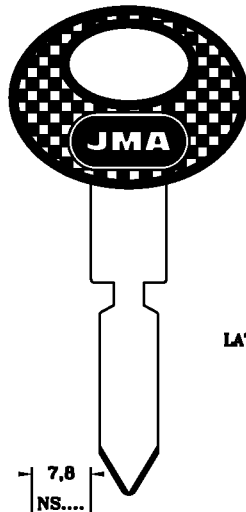

NS....  
7,8  
ME-3.P

MERCEDES  
YMOS

LAT.

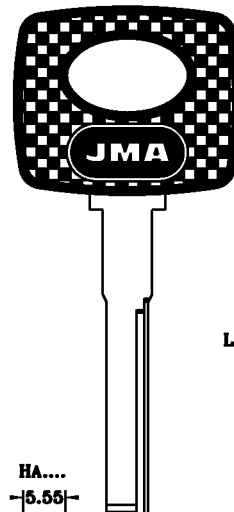

HA....  
-5.55  
ME-4.P

MERCEDES  
YMOS

LAT.

Copyright by  
Alejandro Altuna S.A.  
2005

JMA

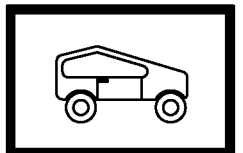

151

**PARA-FOR:**

**HUF (D)**

**PARA: HUF**  
**FOR:**

**PARA: HUF**  
**FOR:**

**PARA: HUF**  
**FOR:**

Copyright by Alejandro Altuna S.A. 2005

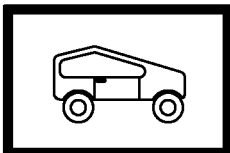

PARA:  
FOR:

HUF

PARA-FOR:

HUF (D)

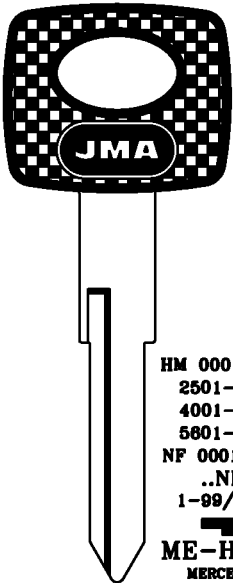

HM 0001-1200  
2501-3500  
4001-5795  
5801-7350  
NF 0001-1200  
..NF..  
1-99/1-99  
ME-HML.P  
MERCEDES  
YMOS

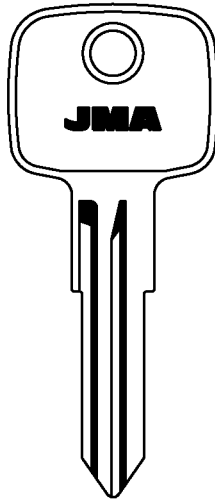

HU  
8001-8130  
ME-HU  
NU  
8001-8130  
ME-NU  
MERCEDES  
YMOS

HY  
8001-8130  
ME-HY  
NY  
8001-8130  
ME-NY

PARA:  
FOR:

HUF

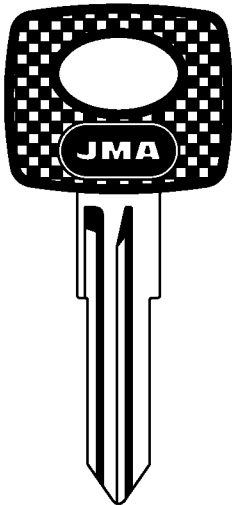

HU  
8001-8130  
ME-HU.P  
NU  
8001-8130  
ME-NU.P  
MERCEDES  
YMOS

HY  
8001-8130  
ME-HY.P  
NY  
8001-8130  
ME-NY.P

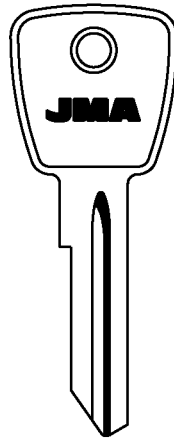

L  
001-300  
ME-L  
MERCEDES  
IMSA-YMOS

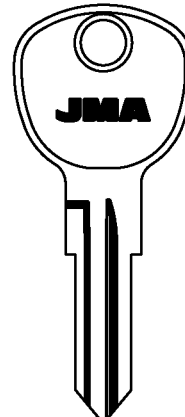

S  
101-295  
401-485  
501-895  
ME-S  
MERCEDES  
CASI

PARA:  
FOR:

HUF

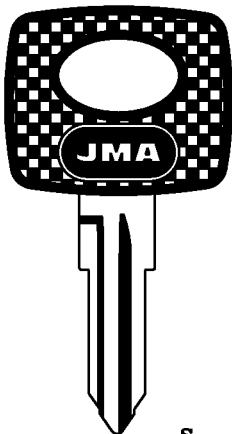

S  
101-295  
401-485  
501-895  
ME-S.P  
MERCEDES  
CASI

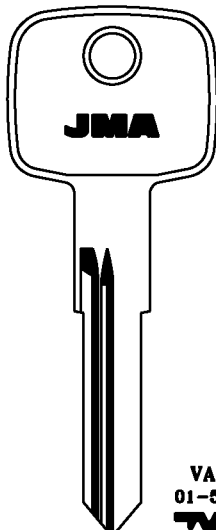

VA  
01-50  
ME-VA  
HANOMAG-MERCEDES  
CASI

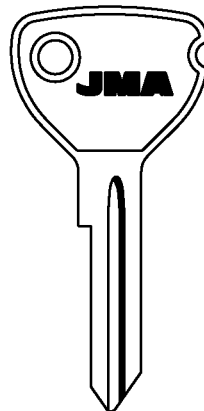

OP-1

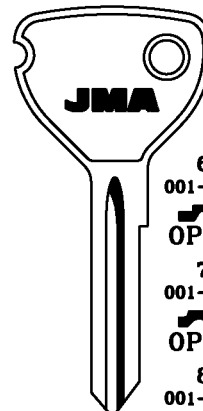

6  
001-250  
OP-6  
7  
001-250  
OP-7  
8  
001-250  
OP-8  
9  
001-250  
OP-9  
DAEWOO-OPEL-VAUXHALL  
YMOS

Copyright by  
Alejandro Altuna S.A.  
2005

JMA

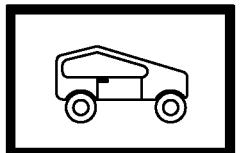

153

**PARA-FOR:**

PARA:  
FOR:

**HUF**

**HUF (D)**

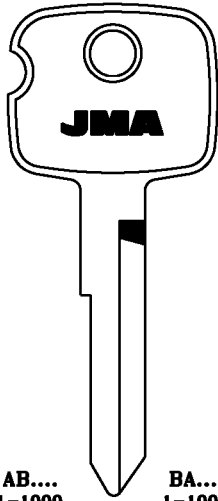

AB...  
1-1000



OP-AB

DAEWOO-HOLDEN-OPEL-VAUXHALL  
YMOS

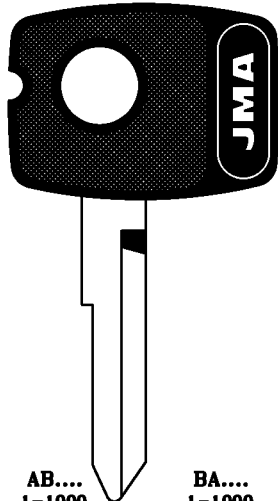

AB...  
1-1000



OP-AB.P

DAEWOO-HOLDEN-OPEL-VAUXHALL  
YMOS

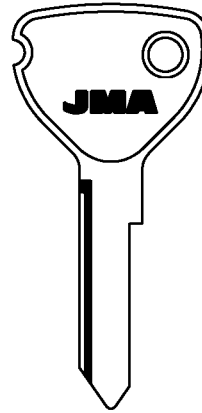

B...1-380

BB...501-1000  
BB...1751-2000  
BB...2501-3000



OP-BB

CC...501-1000  
CC...1751-2000  
CC...2501-3000



OP-CC

DD...501-1000  
DD...1751-2000  
DD...2501-3000



OP-DD

EE...501-1000  
EE...1751-2000  
EE...2501-3000



OP-EE

DAEWOO-OPEL-VAUXHALL

FF...501-1000  
FF...1751-2000  
FF...2501-3000



OP-FF

PARA:  
FOR:

**HUF**

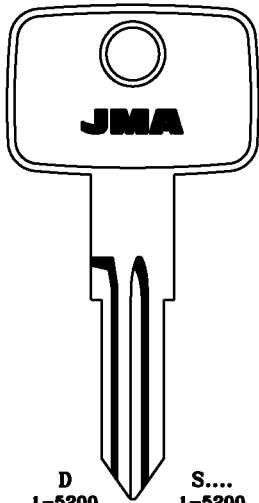

D  
1-5200



OP-D

DAEWOO-GM-LOTUS-OPEL-VAUXHALL  
YMOS

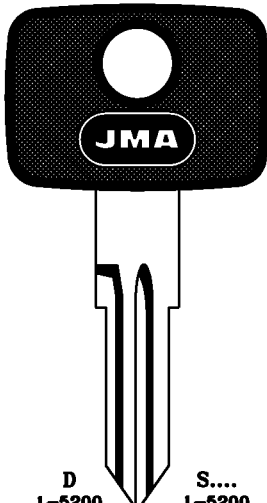

D  
1-5200



OP-D.P

S...  
1-5200



OP-S.P

DAEWOO-GM-LOTUS-OPEL-VAUXHALL  
YMOS

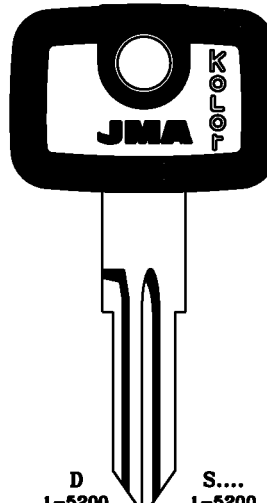

D  
1-5200



OP-DK.P

S...  
1-5200



OP-SK.P

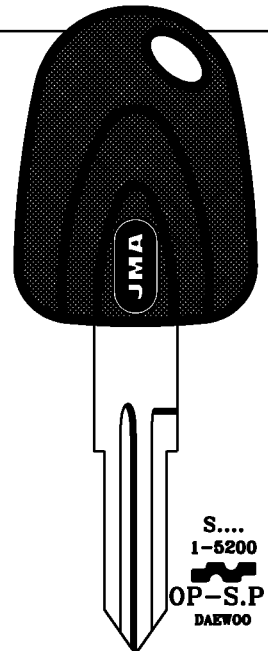

S...  
1-5200



OP-S.P1

DAEWOO

PARA:  
FOR:

**HUF**

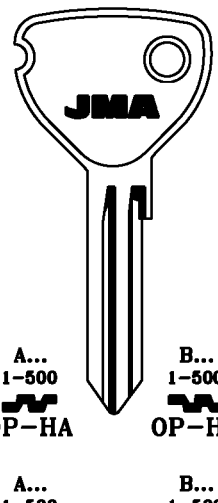

A...  
1-500



OP-HA

B...  
1-500



OP-HB

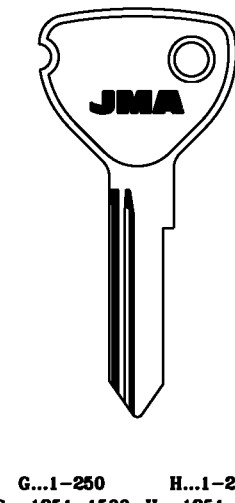

G...1-250 H...1-250  
G...1251-1500 H...1251-1500



OP-HG



OP-HH

OPEL-VAUXHALL

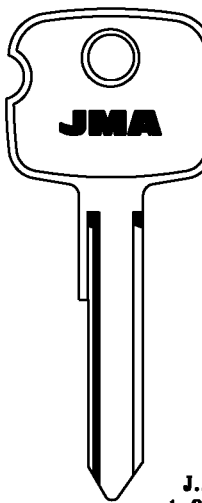

J...  
1-2874



OP-J

DAEWOO-HOLDEN-OPEL-VAUXHALL  
YMOS

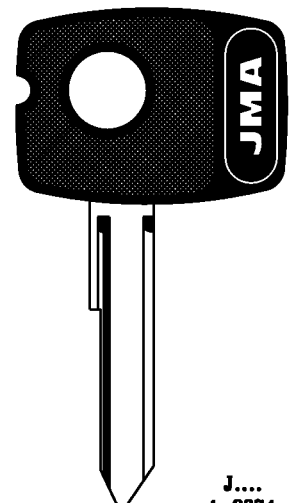

J...  
1-2874



OP-J.P

Copyright by  
Alejandro Altuna S.A.  
2005

**JMA**

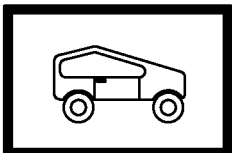

**154**

PARA:  
FOR:

### HUF

PARA-FOR:

### HUF (D)

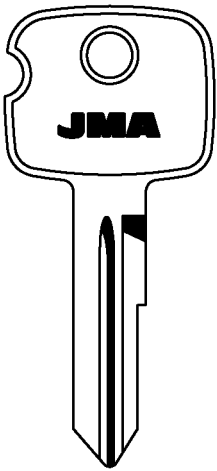

R....  
1-1500



OP-R  
GM-IRMSCHER-OPEL-VAUXHALL  
YMOS

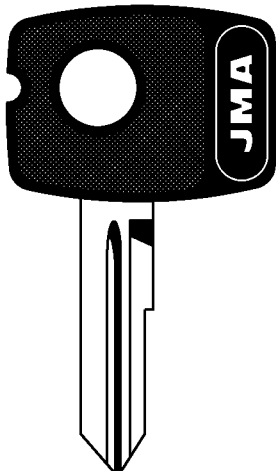

R....  
1-1500



OP-R.P

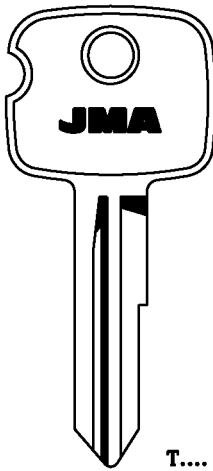

T....  
1-500  
501-1500



OP-T  
GM-IRMSCHER-OPEL-VAUXHALL  
YMOS

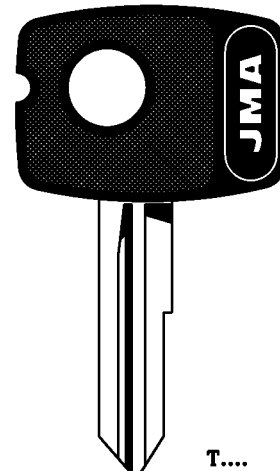

T....  
1-500  
501-1500



OP-T.P

PARA:  
FOR:

### HUF

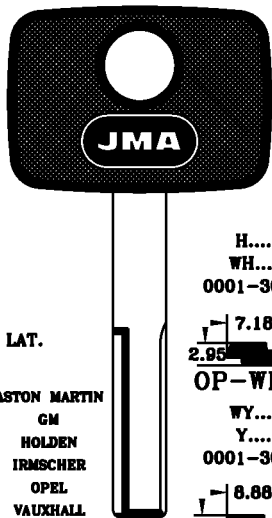

LAT.  
ASTON MARTIN  
GM  
HOLDEN  
IRMSCHER  
OPEL  
VAUXHALL

H....  
WH....  
0001-3000



OP-WH.P

WY....  
Y....  
0001-3000



OP-WY.P

YMOS

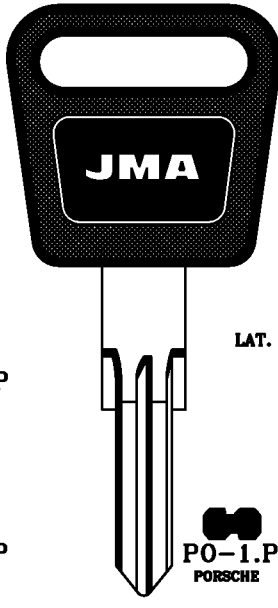

LAT.

PO-1.P  
PORSCHE

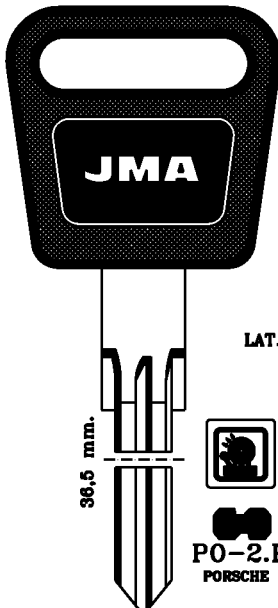

LAT.

38,5 mm.

PO-2.P  
PORSCHE

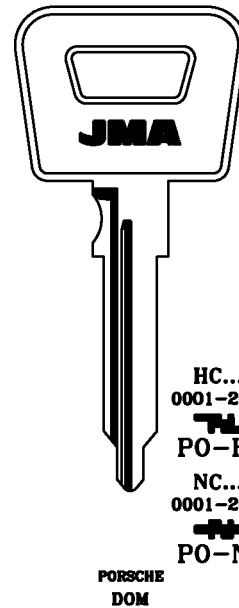

HC....  
0001-2080  
PO-HC  
NC....  
0001-2080  
PO-NC

PORSCHE  
DOM

PARA:  
FOR:

### HUF

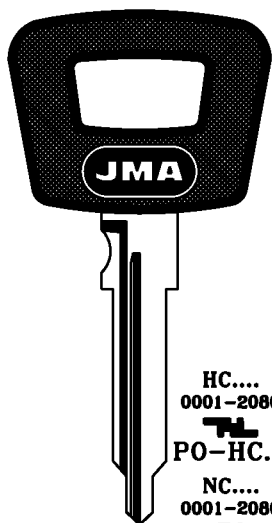

HC....  
0001-2080  
PO-HC.P  
NC....  
0001-2080  
PO-NC.P

PORSCHE  
DOM

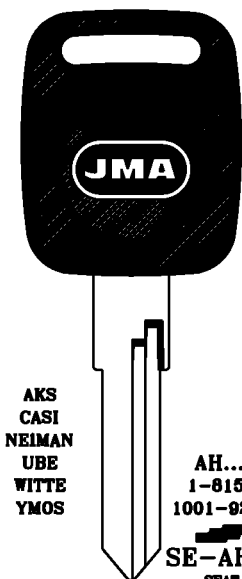

AKS  
CASI  
NEIMAN  
UBE  
WITTE  
YMOS

AH....  
1-8154  
1001-9282

SE-AH.P  
SEAT

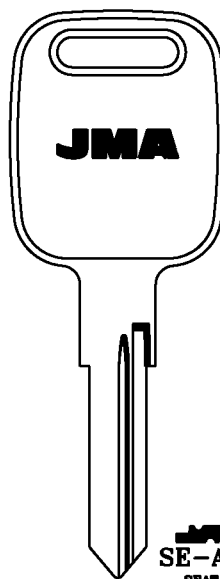

SE-AN  
SEAT

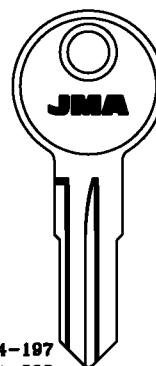

...124-197  
...501-598  
...701-790  
...G08-G10  
...0G1-1G0  
A...101-125  
A...701-790  
G...001-100



VO-1

FIAT IVECO  
NEIMAN

Copyright by  
Alejandro Altuna S.A.  
2005

# JMA

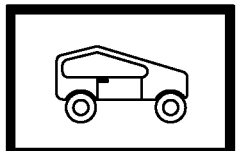

## 155

**PARA-FOR:**

PARA:  
FOR:

**HUF**

**HUF (D)**

AH...  
1-8154  
1001-9282  
VO-2

AH...  
1-8154  
1001-9282  
VO-2.P  
2FF  
VO-8.P

AH...  
1-8154  
1001-9282  
VO-2D.P  
VO-2.P1  
2FF  
VO-8.P1

AH...  
1-8154  
1001-9282  
VO-2K.P  
HV...  
1-8154  
1001-9282  
VO-3K.P  
VO-4K.P

VOLKSWAGEN  
AKS-CASI-UBE-WITTE

VOLKSWAGEN  
VOLKSWAGEN BRASIL

VOLKSWAGEN  
AKS-CASI-UBE-WITTE

PARA:  
FOR:

**HUF**

AN  
001-854  
1001-1918  
2001-2830  
3001-3890  
4001-5151  
8001-7088  
7001-8154  
8201-9282  
VO-5.P

VO-6D

AH...  
1-8154  
1001-9282  
VO-AH  
HV...  
1-8154  
1001-9282  
VO-HV  
VB-NV-MD...  
1-8154  
1001-9282  
VO-VB  
N...  
VO-N

AN...  
001-854  
1001-1918  
2001-2830  
3001-3890  
4001-5151  
8001-7088  
7001-8154  
8201-9282  
AU-AN

CASI-HUF-UBE-WITTE

AUDI-FORD-PORSCHE-VOLKSWAGEN  
AKS-CASI-UBE-WITTE

PARA:  
FOR:

**HUF**

AH...  
1-8154  
1001-9282  
VO-AH.P  
HV...  
1-8154  
1001-9282  
VO-HV.P  
VB-NV-MD...  
1-8154  
1001-9282  
VO-VB.P  
N...  
VO-N.P

AN...  
001-854  
1001-1918  
2001-2830  
3001-3890  
4001-5151  
8001-7088  
7001-8154  
8201-9282  
AU-AN.P

VO-FH  
VOLKSWAGEN

VO-FH.P  
VOLKSWAGEN

AUDI-FORD-PORSCHE-VOLKSWAGEN  
AKS-CASI-UBE-WITTE

Copyright by  
Alejandro Altuna S.A.  
2005

**JMA**

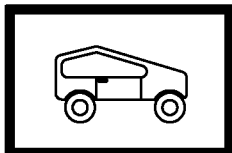

**156**

PARA:  
FOR:

### HUF

PARA-FOR:

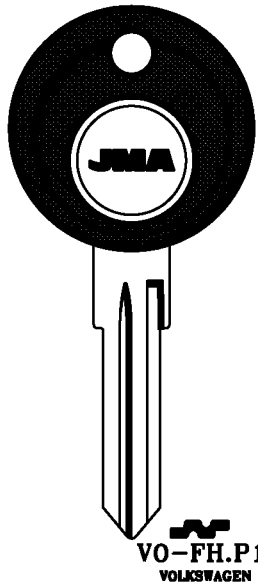

VO-FH.P1  
VOLKSWAGEN

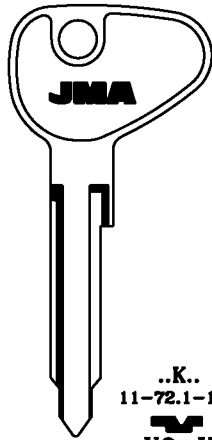

..K...  
11-72.1-110  
VO-K  
..L...  
11-72.1-110  
VO-L  
VOLKSWAGEN  
NEIMAN-WITTE

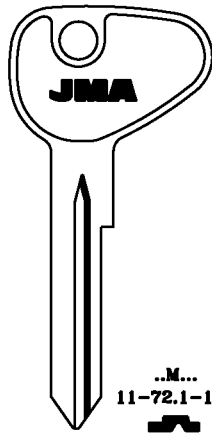

..M...  
11-72.1-110  
VO-M  
..R...  
11-72.1-110  
VO-R  
MAN-VOLKSWAGEN  
AKS-CASI-WITTE

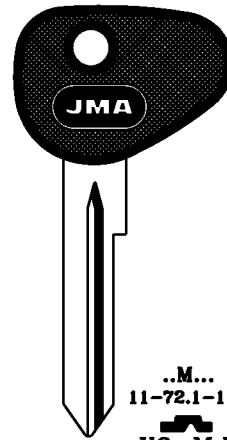

..M...  
11-72.1-110  
VO-M.P  
..R...  
11-72.1-110  
VO-R.P  
MAN-VOLKSWAGEN  
AKS-CASI-WITTE

HUF (D)  
HUWIL (D)  
HYUNDAI (K)

PARA:  
FOR:

### HUF

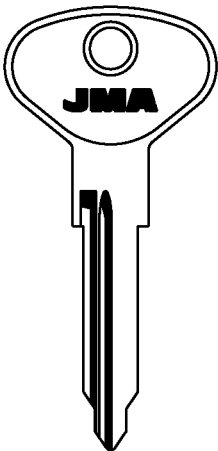

..VA..  
01-55  
VO-VA  
VOLKSWAGEN

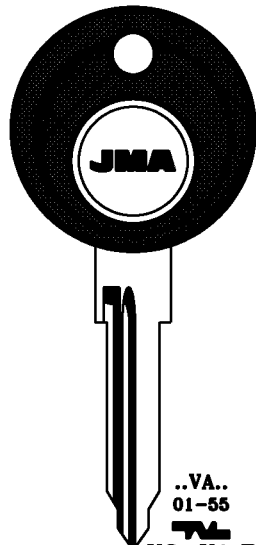

..VA..  
01-55  
VO-VA.P  
VOLKSWAGEN

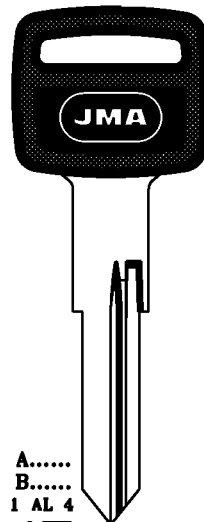

A.....  
B.....  
1 AL 4  
VO-VB.P1  
NEIMAN

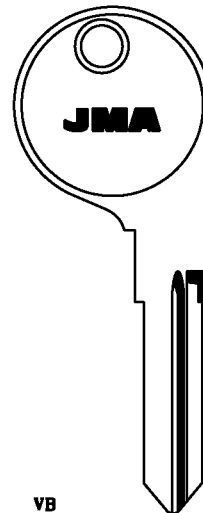

VB  
VW-K70

PARA:  
FOR:

### HUWIL

### HYUNDAI

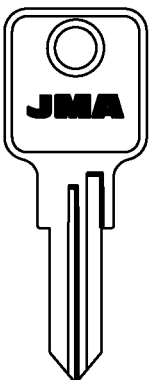

W  
3000-4000  
A  
3001-4000  
HUW-1 HUW-1D  
STRAFOR-STEELCASE



N  
0005-1878  
N  
2001-2204  
HUW-N

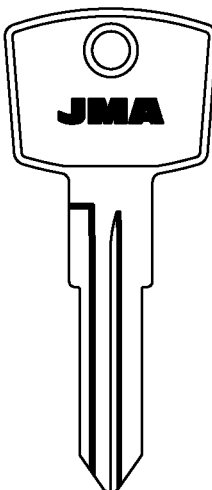

A/Z.... 0111-0333  
HY-1  
HYUNDAI

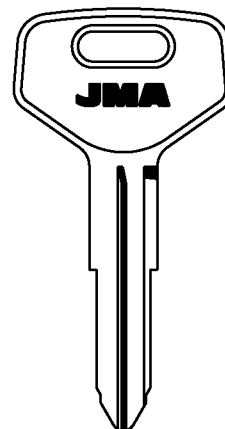

Y  
1001-2000  
HY-2  
HYUNDAI

Copyright by  
Alejandro Altuna S.A.  
2005

JMA

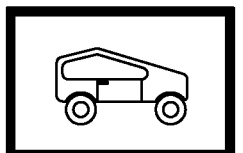

157

**PARA-FOR:**

**PARA:  
FOR:**

**HYUNDAI**

**HYUNDAI (K)**

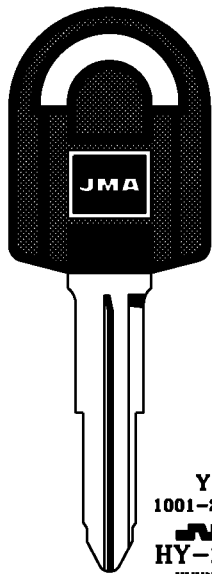

Y  
1001-2000  
HY-2.P  
HYUNDAI

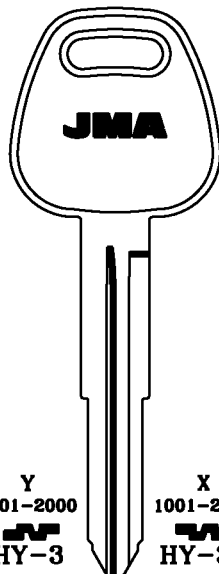

Y  
1001-2000  
HY-3  
HYUNDAI-MITSUBISHI

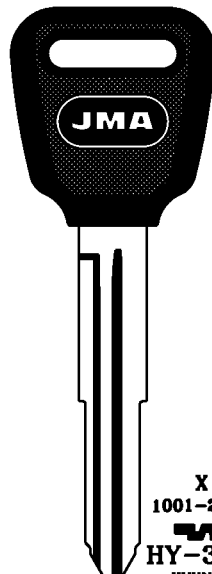

X  
1001-2000  
HY-3D.P  
HYUNDAI

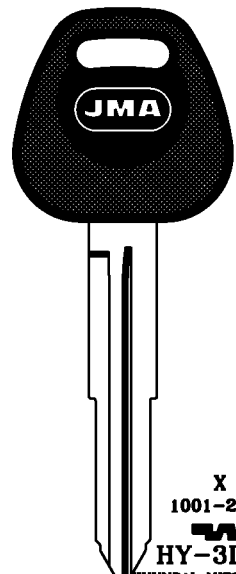

X  
1001-2000  
HY-3D.P1  
HYUNDAI-MITSUBISHI

**PARA:  
FOR:**

**HYUNDAI**

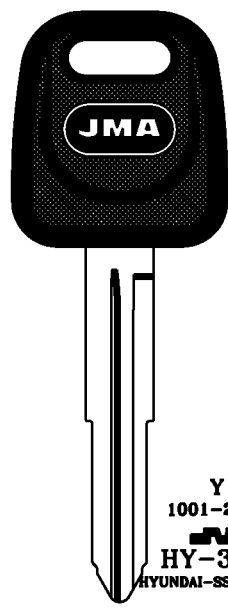

Y  
1001-2000  
HY-3.P2  
HYUNDAI-SSANGYONG

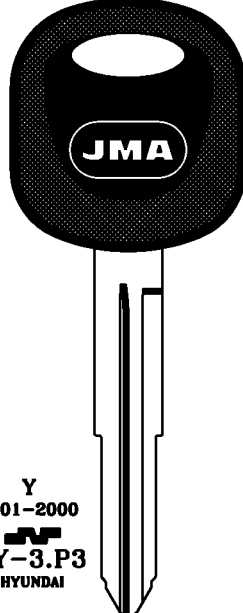

Y  
1001-2000  
HY-3.P3  
HYUNDAI

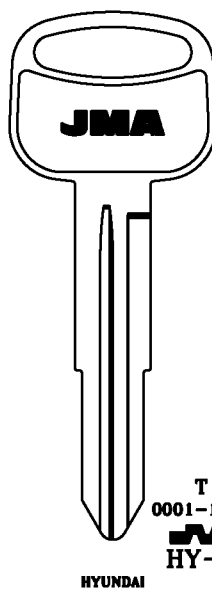

T  
0001-1000  
HY-4  
HYUNDAI

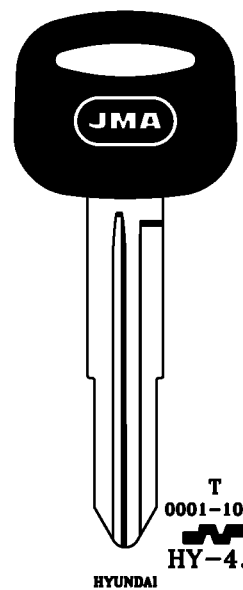

T  
0001-1000  
HY-4.P  
HYUNDAI

**PARA:  
FOR:**

**HYUNDAI**

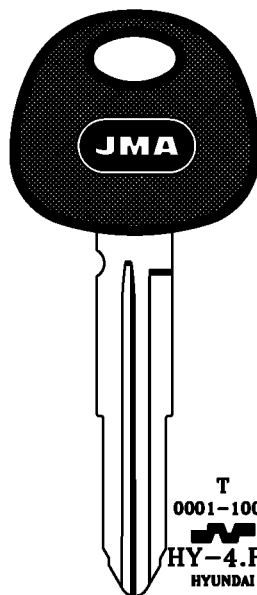

T  
0001-1000  
HY-4.P2  
HYUNDAI

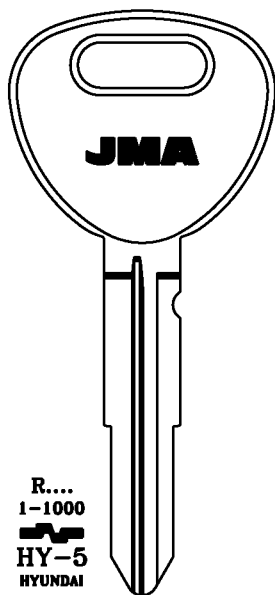

R....  
1-1000  
HY-5  
HYUNDAI

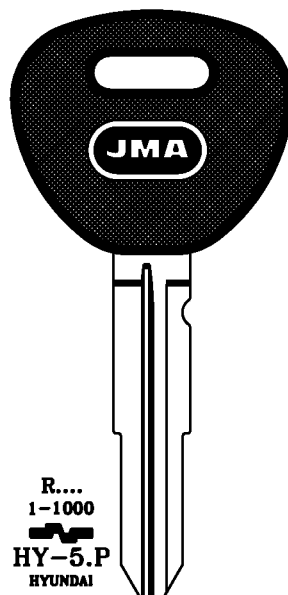

R....  
1-1000  
HY-5.P  
HYUNDAI

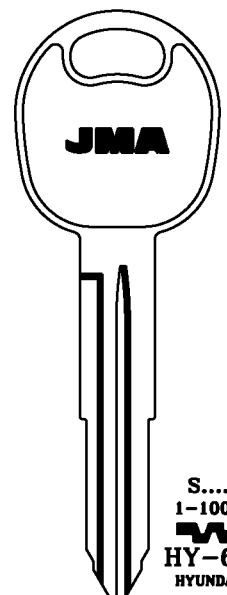

S....  
1-1000  
HY-6D  
HYUNDAI

Copyright by  
Alejandro Altuna S.A.  
2005

**JMA**

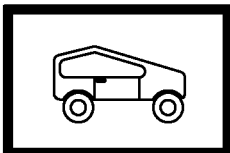

**158**

PARA:  
FOR:

# HYUNDAI

PARA-FOR:

HYUNDAI (K)

IMSA (E)

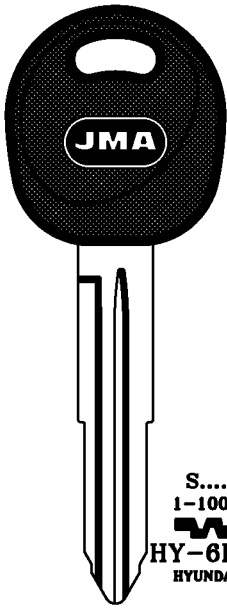

S....  
1-1000  
  
HY-6D.P  
HYUNDAI

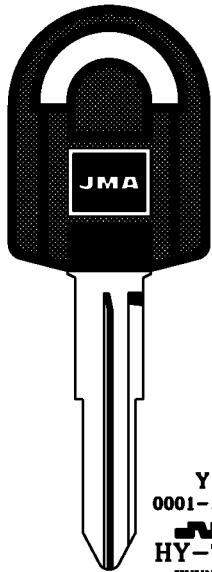

Y  
0001-1000  
  
HY-7.P  
HYUNDAI

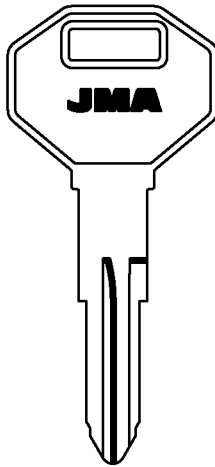

H  
1-2000  
  
HY-8  
HYUNDAI

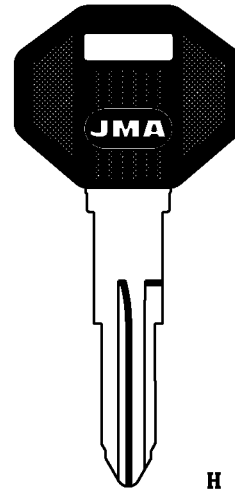

H  
1-2000  
  
HY-8.P  
HYUNDAI

PARA:  
FOR:

# HYUNDAI

# IMSA

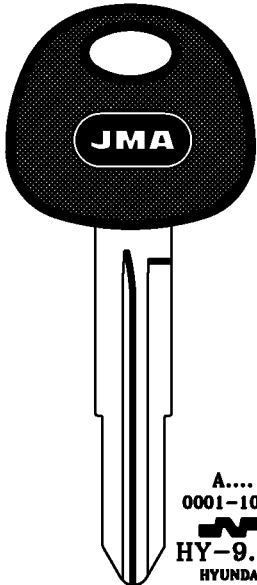

A....  
0001-1000  
  
HY-9.P2  
HYUNDAI

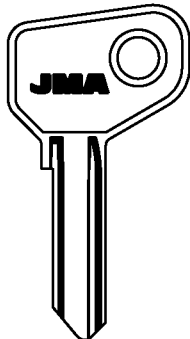

3  
0501-1000  
  
IMS-3C  
1  
0501-1000  
  
IMS-5C

SAFE

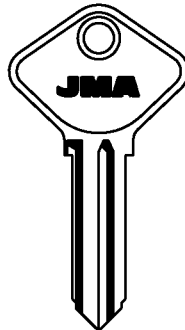

IMS-6I IMS-6D

SAFE

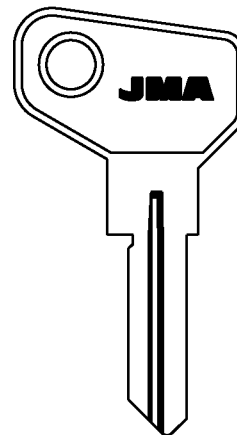

....  
2,3,4,5,6,7,8  
  
IMS-7  
LAND ROVER-SEAT-SUZUKI

PARA:  
FOR:

# IMSA

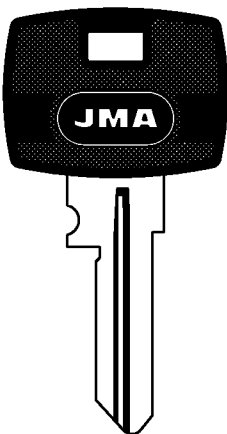

....  
2,3,4,5,8,7,8  
  
IMS-7.P  
LAND ROVER-SEAT-SUZUKI

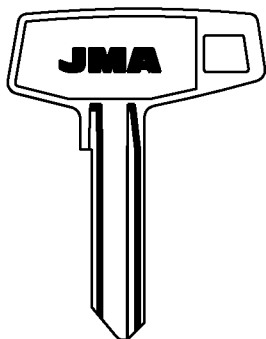

3  
0501-1000  
  
IMS-8  
1  
0501-1000  
  
IMS-9

SAFE

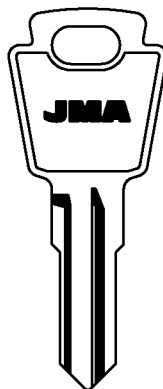

IMS-10  
SUZUKI

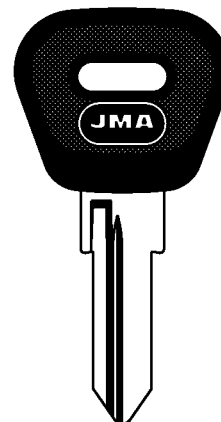

IMS-11.P  
SUZUKI

Copyright by  
Alejandro Altuna S.A.  
2005

# JMA

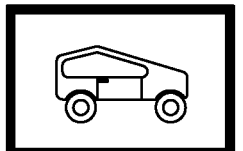

# 159





**PARA-FOR:**



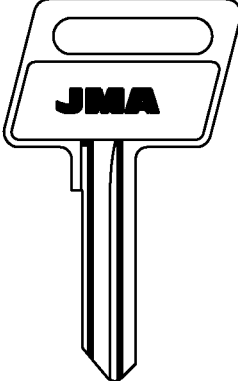
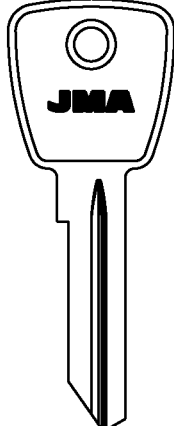

IMSA (E)

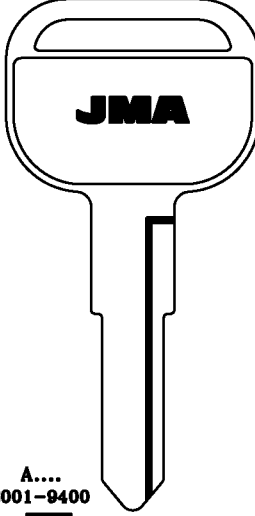
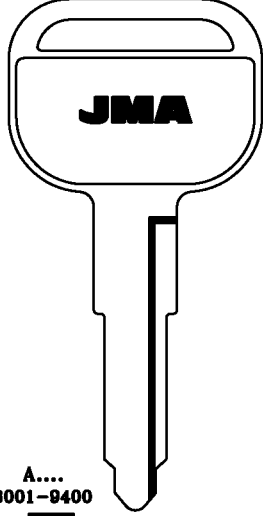



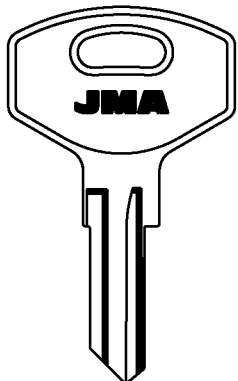

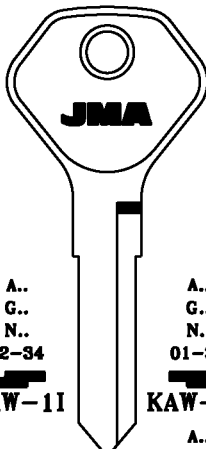
ISUZU (J)

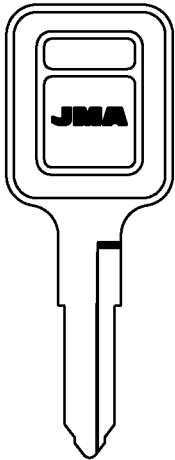

KAMAZ (RUS)

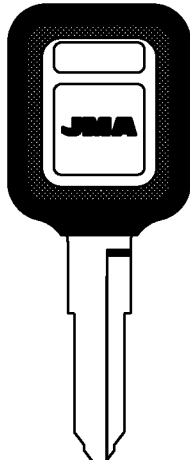
KAWASAKI (J)

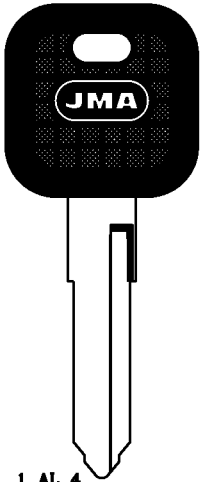
<b>PARA: FOR:</b>	<b>IMSA</b>	<b>ISUZU</b>
	  1 0501-1000  IMS-12 SAFE	  A.... 8001-9400  ISU-1 ISUZU

<b>PARA: FOR:</b>	<b>KAMAZ</b>	<b>KAWASAKI</b>
	  KAM-1 ZIL	 A.. G.. N.. 02-34  KAW-1I KAWASAKI

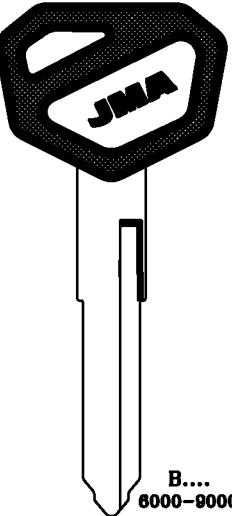
<b>PARA: FOR:</b>	<b>KAWASAKI</b>		
	 Z.... 5000-8000  KAW-5 KAWASAKI	 Z.... 5000-8000  KAW-5.P KAWASAKI	 B.. 1 AL 4 H.. 1 AL 4  KAW-6.P KAW-6D.P CAGIVA-DUCATI-KAWASAKI

 B.... 6000-9000  KAW-7.P KAWASAKI
---

Copyright by  
Alejandro Altuna S.A.  
2005

**JMA**

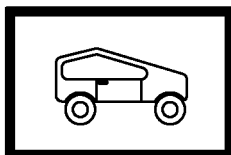

**160**

PARA: FOR:	KAWASAKI	KENWORTH	KIA
	  Z.... 5000-6000 <b>KAW-9.P</b> KAWASAKI	 C.... 250-499 1701-1950  <b>KEN-1 KEN-1D</b> BASCO	 Y.... 7001-8200 <b>KI-1D</b> FORD (AUSTRALIA)-KIA

**PARA-FOR:**  
**KAWASAKI (J)**  
**KENWORTH (USA)**  
**KIA (K)**  
**KYMCO (K)**  
**LADA BAKONY (RUS)**

PARA: FOR:	KIA			
	 Y.... 7001-8200 <b>KI-1D.P</b> FORD (AUSTRALIA)-KIA	 Y.... 7001-8200 <b>KI-1D.P1</b> FORD (AUSTRALIA)-KIA	 Y.... 7001-8200 <b>KI-2D</b> FORD (AUSTRALIA)-KIA	 Y.... 2001-3000 <b>KI-3.P KI-3D.P</b>

PARA: FOR:	KYMCO	LADA BAKONY		
	 <b>KYM-1.P KYM-1D.P</b>	 LU... 0001-1280 <b>LA-1D</b> LADA	 LU... 0001-1280 <b>LA-1D.P</b> LADA	 TU... 0001-1000 <b>LA-2</b> LADA

Copyright by  
 Alejandro Altuna S.A.  
 2005

**JMA**

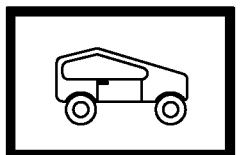

**161**

**PARA-FOR:**

**LADA BAKONY  
(RUS)**

**LAS (F)**

**PARA:  
FOR:**

**LADA BAKONY**

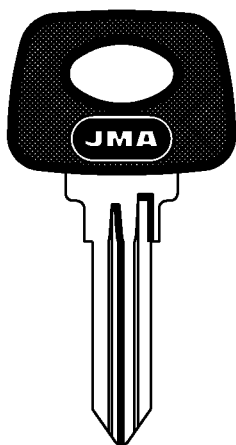

TU...  
0001-1000  
LA-2.P  
LADA

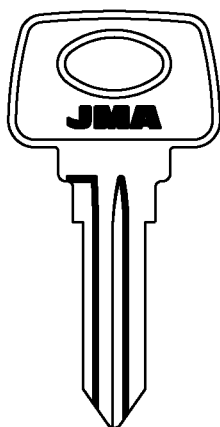

....  
0 AL 3  
LA-3D  
LADA-MOSKVITCH

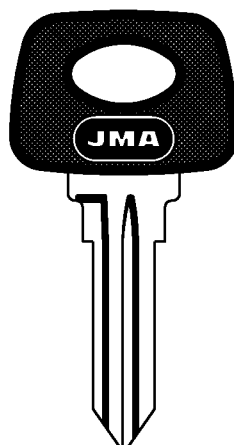

....  
0 AL 3  
LA-3D.P  
LADA-MOSKVITCH

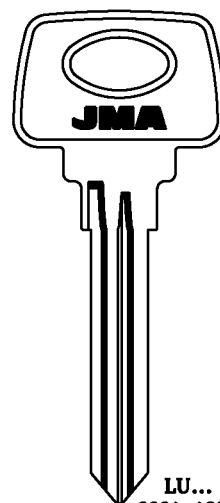

LU...  
0001-1280  
LA-4D  
LADA

**PARA:  
FOR:** LADA B.

**LAS**

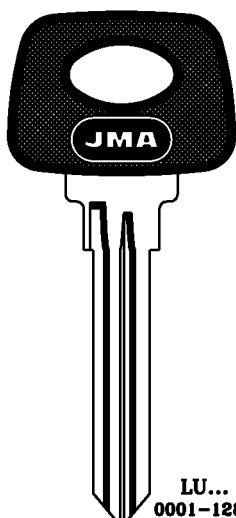

LU...  
0001-1280  
LA-4D.P  
LADA

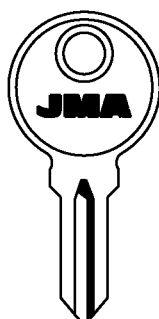

AX  
001-224  
LAS-AX

EX  
LAS-1D

ATAL-HAEFELE-KIFERM-RENZ



ABBES  
ATAL  
DUBOIS  
ORDO  
RENZ  
STRAFOR

FM  
LAS-2

FM  
001-400  
501-550  
LAS-4

FH  
001-400  
501-550  
LAS-FH

LAS-4D

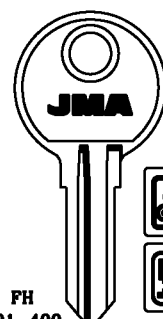

FH  
001-400  
501-550  
LAS-3

H  
LAS-5

U  
LAS-U



E  
LAS-5D

X  
LAS-X

KIFERM

**PARA:  
FOR:**

**LAS**

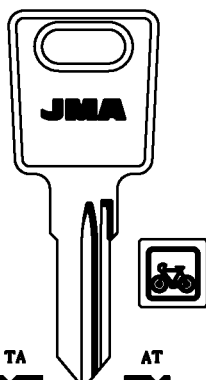

TA  
LAS-6  
AT  
LAS-6D

RM  
0001-2000

KT  
3001-4000

LAS-KT  
LAS-TK

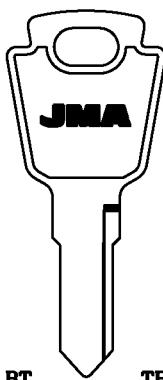

BT  
001-850  
LAS-BT

CR  
001-850

LAS-CR

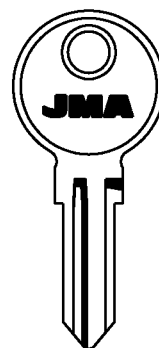

P  
001-224  
LAS-P

KIFERM-PJ

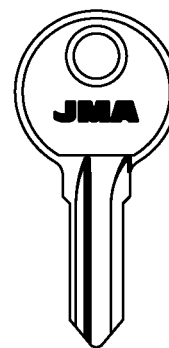

R  
001-224  
LAS-R

Y  
001-224

LAS-Y

DUBOIS-KIFERM-PJ-PK

ATAL-KIFERM-MARCADET-RONIS

Copyright by  
Alejandro Altuna S.A.  
2005

**JMA**

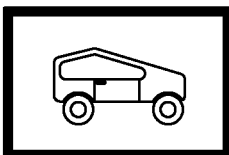

**162**

ATENCION:Concerniente a las marcas y denominaciones comerciales ver nota en indice.ATTENTION:Concerning the marks and commercial denominations see note in index.  
ATTENTION:Concernant les marques et denominations commerciales voir la note dans l'index.ACHTUNG:Beziehen auf die marke und handelsname sehen sie die notiz im index.

PARA:  
FOR:

LAS

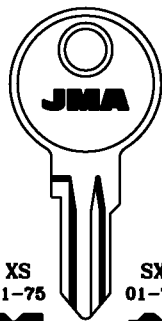

XS 01-75  
LAS-XS  
SX 01-75  
LAS-SX  
TX 01-75  
LAS-TX  
XY 01-75  
LAS-XY

ATAL-JU-KIFERM-METEOR-RENZ

LMP



10055-12538

LMP-1  
EBRO-PEUGEOT-RENAULT  
GELBON-ROS-SEIMA

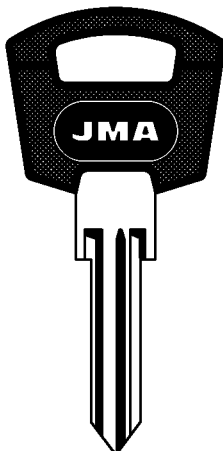

10055-12538

LMP-1.P  
EBRO-PEUGEOT-RENAULT  
GELBON-ROS-SEIMA

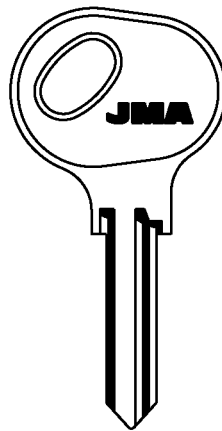

20000-25527  
50001-52500

LMP-2  
PEUGEOT-RENAULT  
GELBON-SEIMA

PARA-FOR:

LAS (F)

LMP (F)

L. & F. (GB)

PARA:  
FOR:

LMP

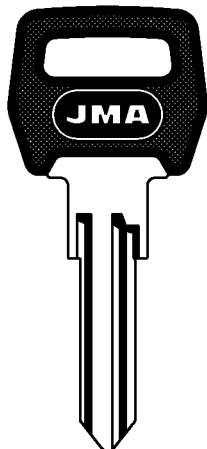

20000-25527  
50001-52500

LMP-2.P  
PEUGEOT-RENAULT  
GELBON-SEIMA

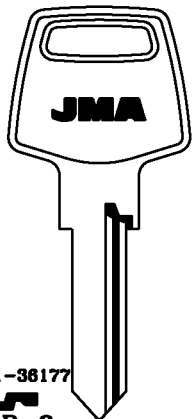

35001-36177

LMP-3

70001-72500  
75000-77500  
1AA-7FZ

LMP-4  
PEUGEOT-RENAULT-TALBOT  
GELBON-SEIMA

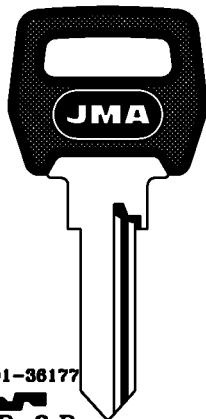

35001-36177

LMP-3.P

70001-72500  
75000-77500  
1AA-7FZ

LMP-4.P  
PEUGEOT-RENAULT-TALBOT  
GELBON-SEIMA

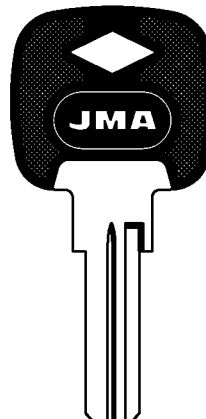

70001-72500  
75000-77500  
1AA-7FZ

LMP-5.P  
RENAULT  
GELBON-SEIMA

PARA:  
FOR:

LOWE & FLETCHER



90...1-200  
...1-400  
91...201-275  
GH...1-4000  
SS...1-400  
91...276-350

LF-11 LF-1D  
CEM-EURO LOCKS-UNION

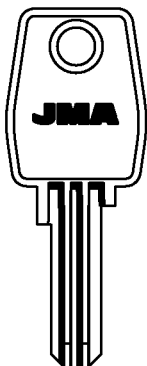

95001-97000  
97001-99000

LF-2

LF-12 LF-12D  
BICICLETTE CYCLES  
DOBLE SAFE-EURO LOCKS

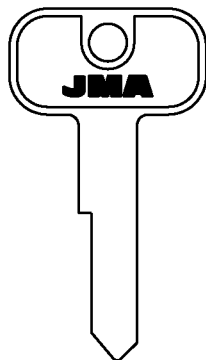

RL-RM  
801-952

LF-3

STREBOR

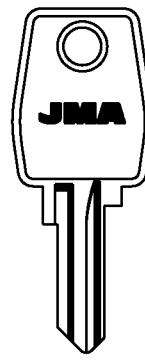

LF-4I

EURO LOCKS

Copyright by  
Alejandro Altuna S.A.  
2005

JMA



163

**PARA-FOR:**

**L. & F. (GB)**

**PARA:  
FOR:**

**LOWE & FLETCHER**

....  
70001-71000  
M....  
70001-71000

LF-5      LF-5D

LF-32

TELTFORD

FV-VM  
101-225  
301-360  
VT...  
400-474

LF-6

CHRYSLER-VAUXHALL-BEDFORD-FORD

.....

68001-87200      61001-87000

LF-7      LF-7D

FORD EUROPA

93...201-400  
.....93901-94000

LF-8      LF-8D

93...401-900  
.....90901-90975

LF-11      LF-11D

EURO LOCKS-MIBRA-UTZ

**PARA:  
FOR:**

**LOWE & FLETCHER**

16.6 mm

60... 001-200  
60... 001-200  
90... 001-200  
...1-400  
GHM...1-155  
M...1-400  
RV...1-400  
RVM...1-400  
SP...1-400  
99...1-400

LF-15      LF-15D

FFE  
001-100

LF-17

15001-19000  
85001-87000

LF-9

ROVER-BEDFORD  
BRITAX

CEM-EURO LOCKS-ULTRA-UNION

LF-28

EURO LOCKS

BL...  
BL...N  
1001-2000

LF-BL

BRITAX

**PARA:  
FOR:**

**LOWE & FLETCHER**

AUSTIN  
CARBODIES  
INNOCENTI  
LAND ROVER  
LOTUS  
MASERATI  
OM IVECO  
ROVER  
VAUXHALL  
BEDFORD  
FIAT IVECO

RO  
BL...N  
1001-2000

LF-RO

AUSTIN  
CARBODIES  
INNOCENTI  
LAND ROVER  
LOTUS  
MASERATI  
OM IVECO  
ROVER  
VAUXHALL  
BEDFORD  
FIAT IVECO

RO  
BL...N  
1001-2000

LF-RO.P

SL  
5001-7000

LF-SL

CHRYSLER-FORD (USA)-SUNBEAM  
ROOTES

SL  
5001-7000

LF-SL.P

CHRYSLER-FORD (USA)-SUNBEAM  
ROOTES

Copyright by  
Alejandro Altuna S.A.  
2005

**JMA**

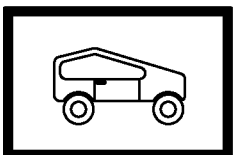

**164**

PARA:  
FOR:

### LOWE & FLETCHER

### MARUTI

PARA-FOR:

L. & F. (GB)

MARUTI (IND)

MAZDA (J)

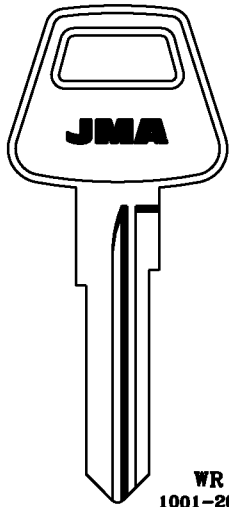

WR  
1001-2000  
LF-WB

TRIUMPH  
WILMOT BREEDEN

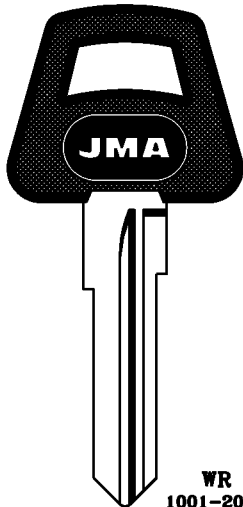

WR  
1001-2000  
LF-WB.P

TRIUMPH  
WILMOT BREEDEN

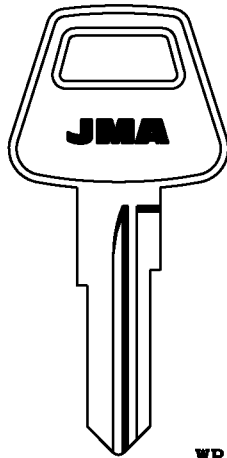

WR  
3000-3999  
5000-5999  
LF-WR

DE LOREAN-FORD (USA)  
WILMOT BREEDEN

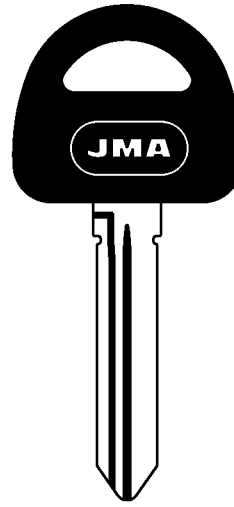

MAR-1.P

PARA:  
FOR:

### MAZDA

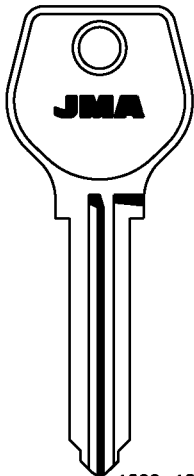

2000-2499 1500-1999  
5000-6100  
MAZ-1I MAZ-1D  
FORD (USA)-MAZDA

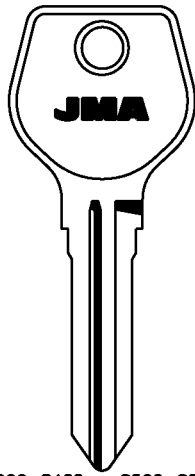

3000-3499 2500-2999  
5000-6100 3500-4600  
MAZ-2I MAZ-2D  
FORD (AUSTRALIA)-MAZDA

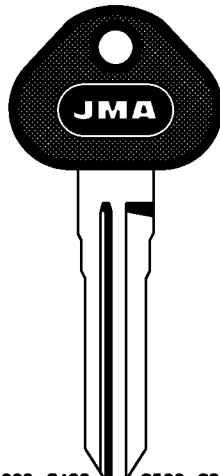

3000-3499 2500-2999  
5000-6100 3500-4600  
MAZ-2I.P MAZ-2D.P  
FORD (AUSTRALIA)-MAZDA

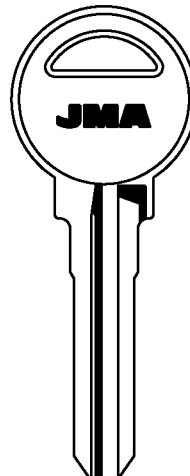

6500-7733  
MAZ-3I MAZ-3D  
MAZDA

PARA:  
FOR:

### MAZDA

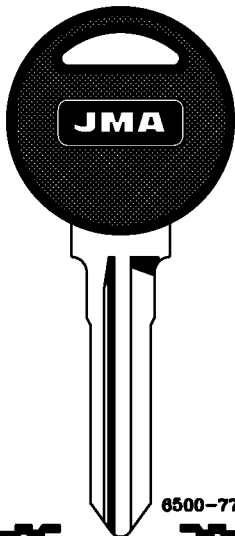

6500-7733  
MAZ-3I.P MAZ-3D.P  
MAZDA

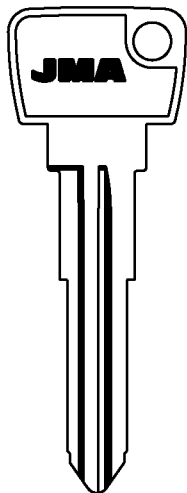

MAZ-4  
MAZDA

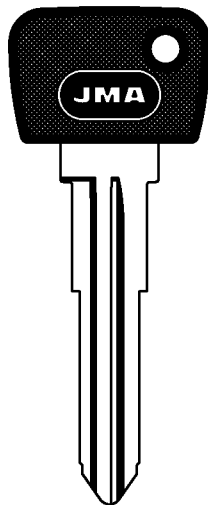

MAZ-4.P  
MAZDA

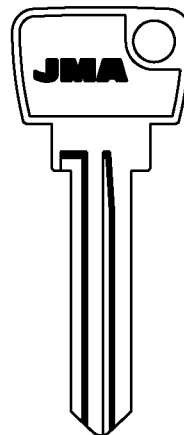

FA....  
6500-7733  
MAZ-5D  
MAZDA

Copyright by  
Alejandro Altuna S.A.  
2005

# JMA

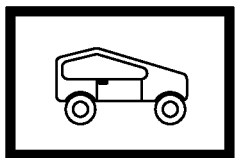

# 165

**PARA-FOR:**

**PARA:  
FOR:**

**MAZDA**

**MAZDA (J)**

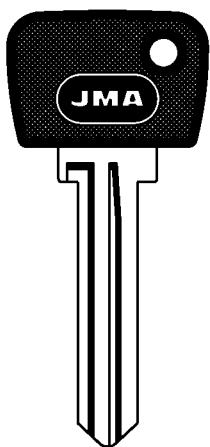

FA....  
6500-7733  
MAZ-5D.P  
MAZDA

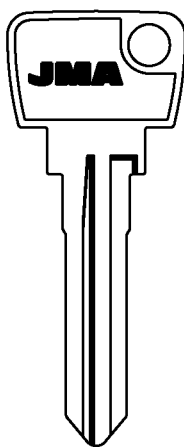

....  
6500-7733  
MAZ-6 MAZ-6D  
FORD (USA)-MAZDA

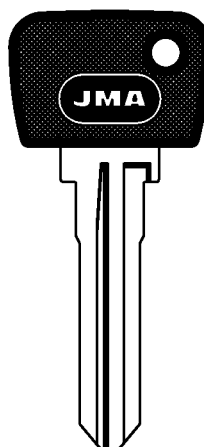

....  
6500-7733  
MAZ-6.P MAZ-6D.P  
FORD (USA)-MAZDA

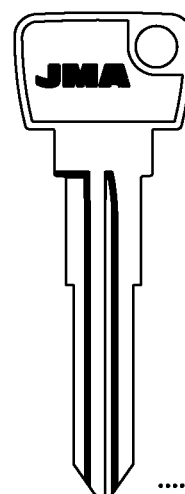

....  
10100-12099  
MAZ-7D  
MAZDA

**PARA:  
FOR:**

**MAZDA**

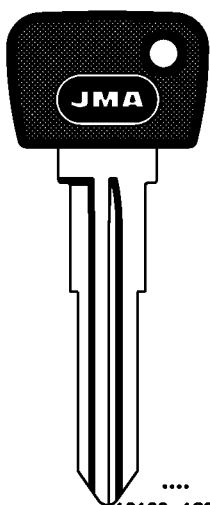

....  
10100-12099  
MAZ-7D.P  
MAZDA

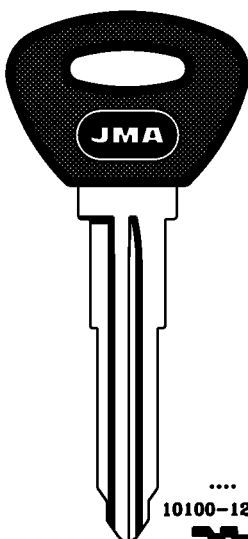

....  
10100-12099  
MAZ-7D.P1  
MAZDA

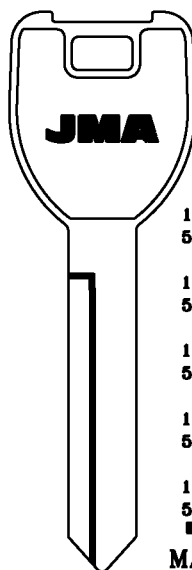

....A...  
101-291  
501-579  
....B...  
101-332  
501-602  
....C...  
101-344  
501-624  
....D...  
101-327  
501-602  
....E...  
101-296  
501-579  
MAZ-8D  
MAZDA

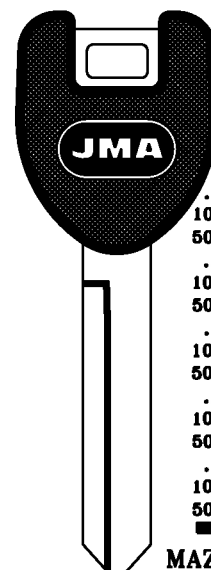

....A...  
101-291  
501-579  
....B...  
101-332  
501-602  
....C...  
101-344  
501-624  
....D...  
101-327  
501-602  
....E...  
101-296  
501-579  
MAZ-8D.P  
MAZDA

**PARA:  
FOR:**

**MAZDA**

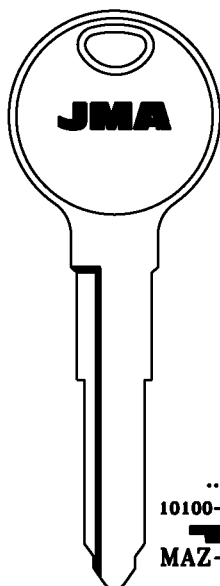

....  
10100-12099  
MAZ-11D

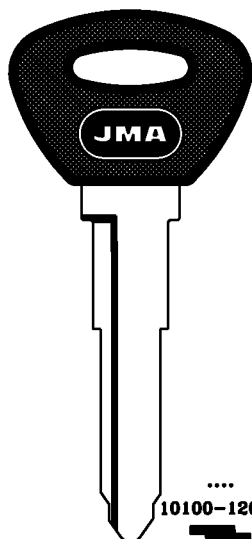

....  
10100-12099  
MAZ-11D.P1

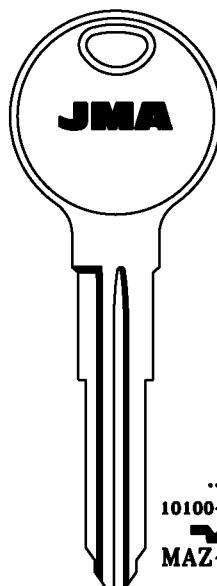

....  
10100-12099  
MAZ-13D

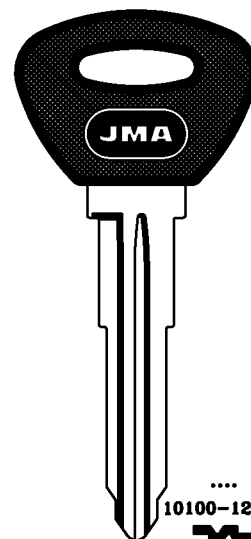

....  
10100-12099  
MAZ-13D.P

Copyright by  
Alejandro Altuna S.A.  
2005

**JMA**

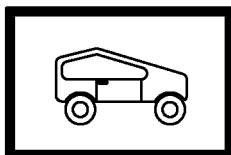

**166**

ATENCION:Concerniente a las marcas y denominaciones comerciales ver nota en indice.ATTENTION:Concerning the marks and commercial denominations see note in Index.  
ATTENTION:Concernant les marques et denominations commerciales voir la note dans l'Index.ACHTUNG:Beziehen auf die marke und handelsname sehen sie die notiz im Index.

PARA:  
FOR:

### MAZDA

PARA-FOR:

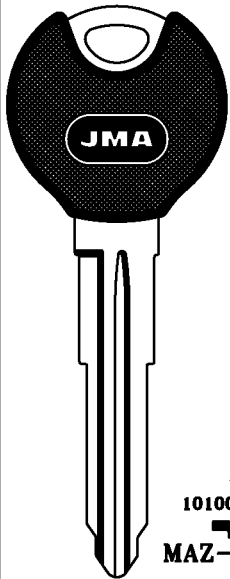

....  
10100-12099  
MAZ-13D.P1

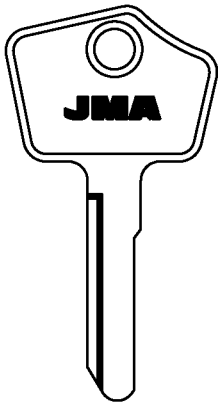

...002-989  
MAZ-14D

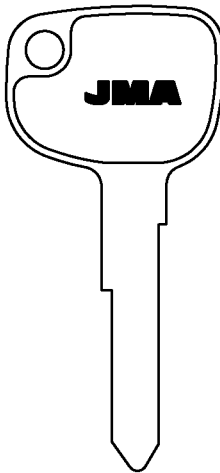

MAZ-15D

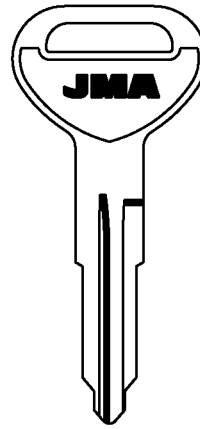

M....  
1-3392  
MAZ-16

**MAZDA (J)**  
**MERIT-LINDE (D)**  
**MITSUBISHI (J)**

PARA:  
FOR: MERIT-LIN.

### MITSUBISHI

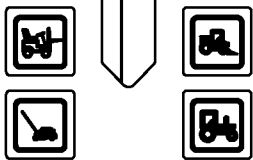
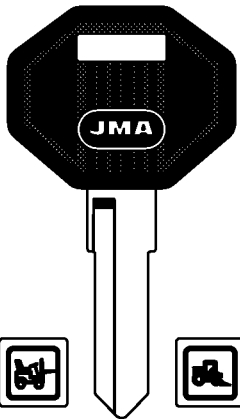

MERI-1D.P

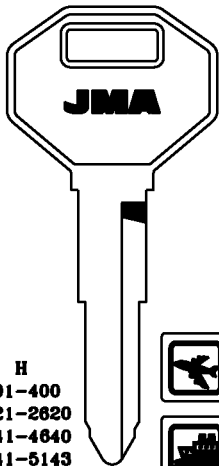

H  
001-400  
2221-2620  
4441-4640  
4641-5143  
E  
2001-3000

MIT-11



MIT-1D MIT-11.P  
CHRYSLER-HOLDEN-ISUZU-MITSUBISHI

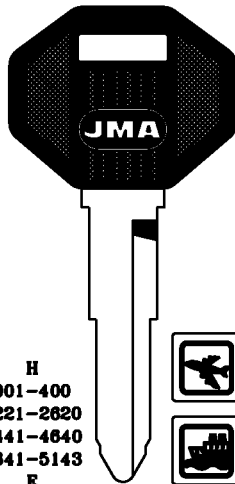

H  
001-400  
2221-2620  
4441-4640  
4641-5143  
E  
2001-3000

MIT-1D.P

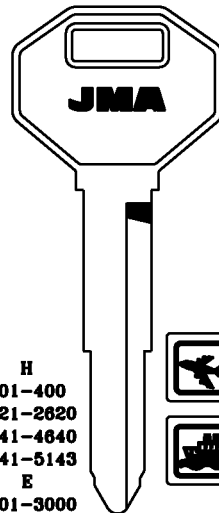

H  
001-400  
2221-2620  
4441-4640  
4641-5143  
E  
2001-3000

MIT-2I



MIT-2D  
CHRYSLER-GM-HYUNDAI-ISUZU  
MITSUBISHI-SUZUKI

PARA:  
FOR:

### MITSUBISHI

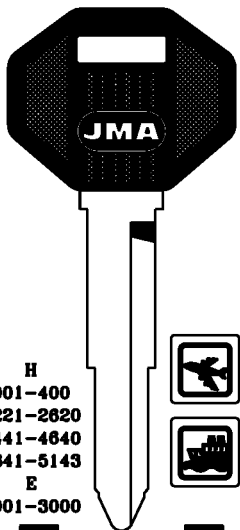

H  
001-400  
2221-2620  
4441-4640  
4641-5143  
E  
2001-3000

MIT-2I.P



MIT-2D.P  
CHRYSLER-GM-HYUNDAI-ISUZU  
MITSUBISHI-SUZUKI

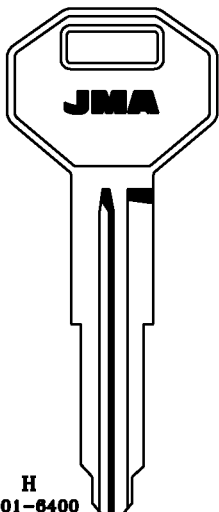

H  
7001-8400

MIT-3

MITSUBISHI-OPEL

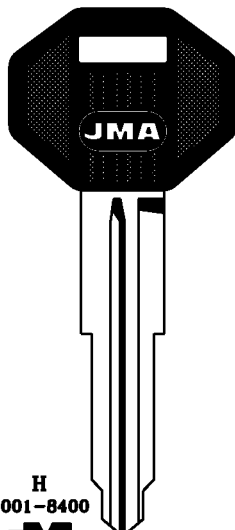

H  
7001-8400

MIT-3.P

MITSUBISHI-OPEL

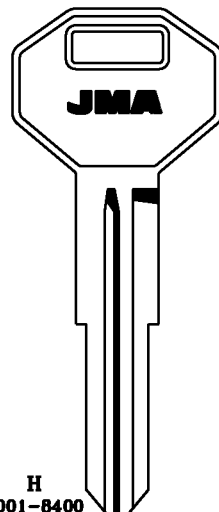

H  
7001-8400

MIT-4

MITSUBISHI

Copyright by  
Alejandro Altuna S.A.  
2005

# JMA

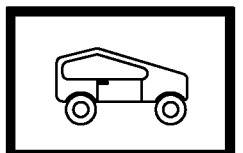

## 167

**PARA-FOR:**

**MITSUBISHI  
(J)**

**PARA:  
FOR:**

**MITSUBISHI**

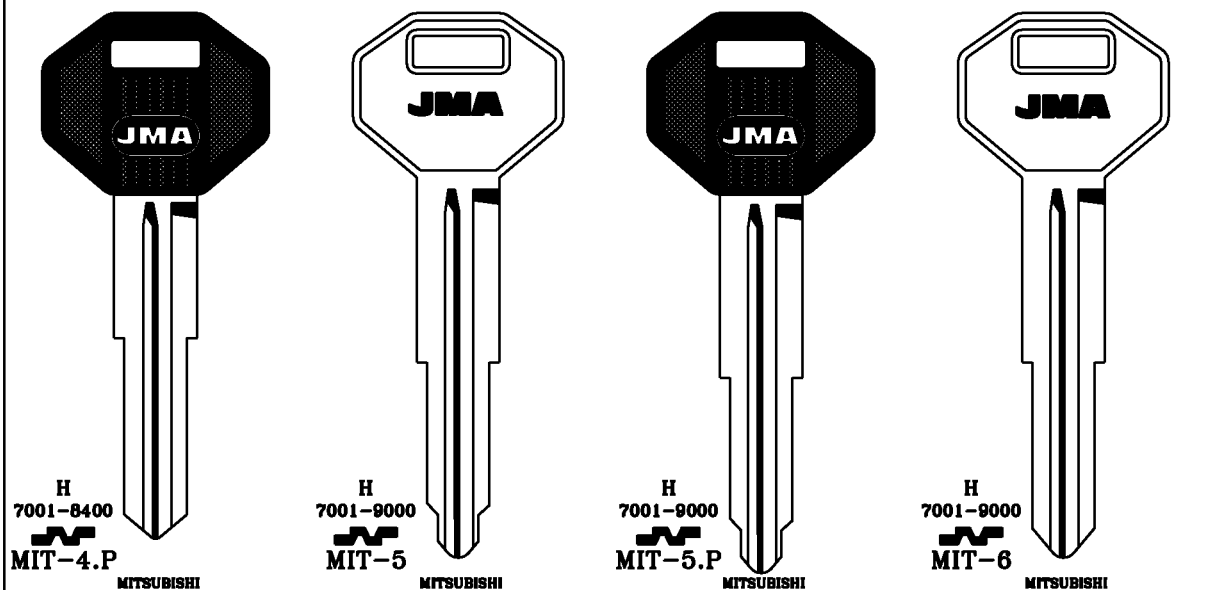

**PARA:  
FOR:**

**MITSUBISHI**

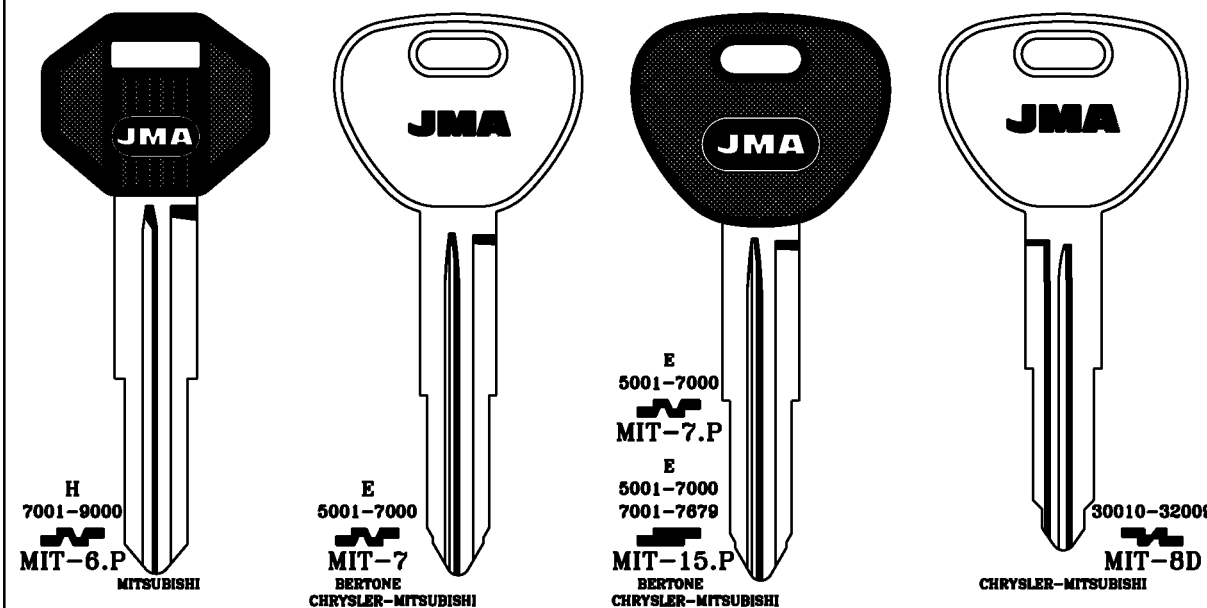

**PARA:  
FOR:**

**MITSUBISHI**

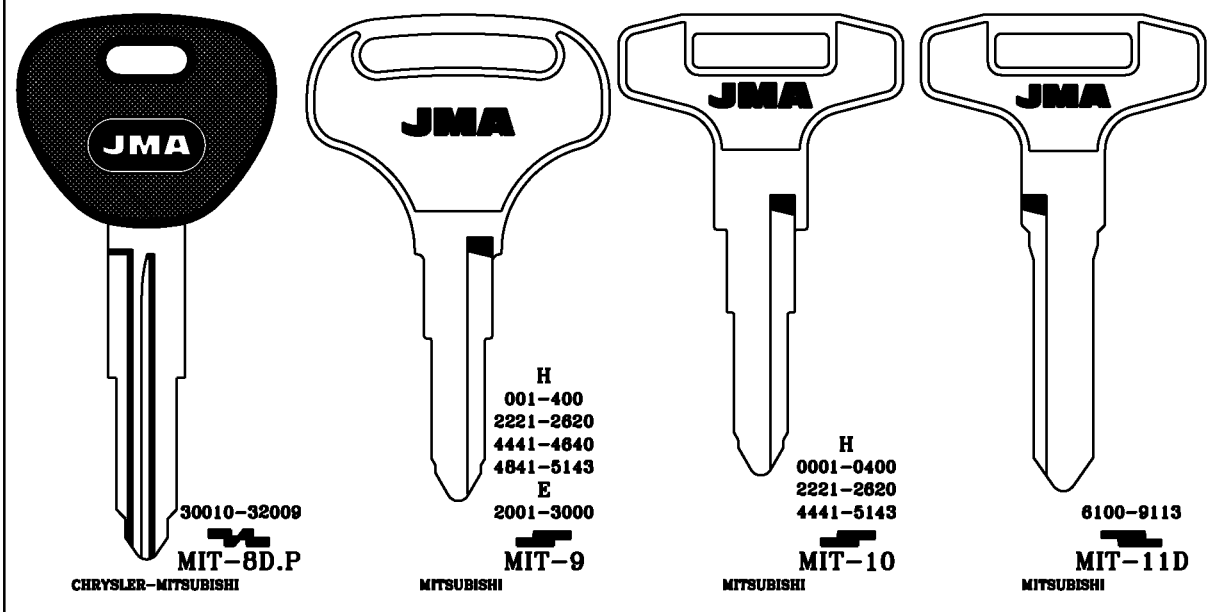

Copyright by  
Alejandro Altuna S.A.  
2005

**JMA**

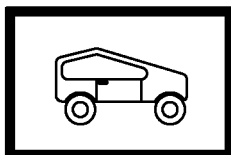

**168**

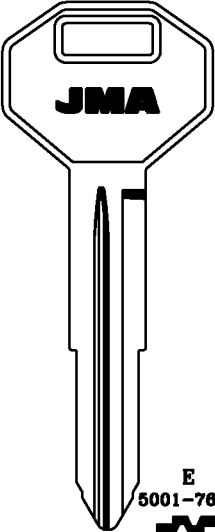
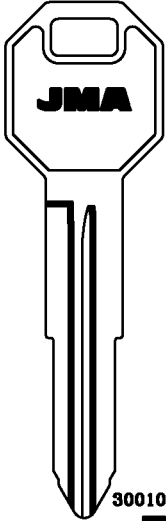
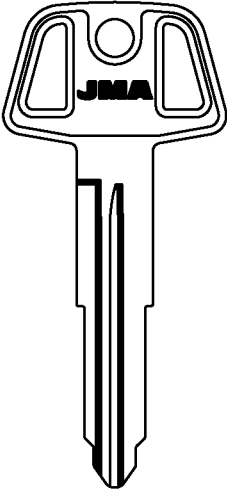
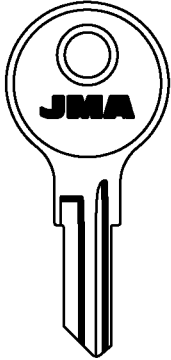
<b>PARA: FOR:</b>	<b>MITSUBISHI</b>			<b>MOSKVITCH</b>
				
E 5001-7679 MIT-12 BERTONE-CHRYSLER-MITSUBISHI	30010-32009 MIT-13D	30010-32009 MIT-14D CHRYSLER-MITSUBISHI	MOS-1	

**PARA-FOR:**  
**MITSUBISHI (J)**  
**MOSKVITCH (RUS)**  
**NEIMAN (F)**

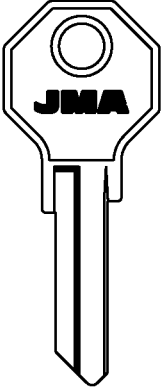
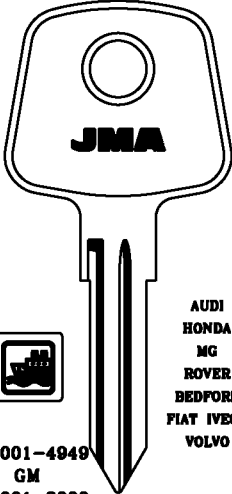
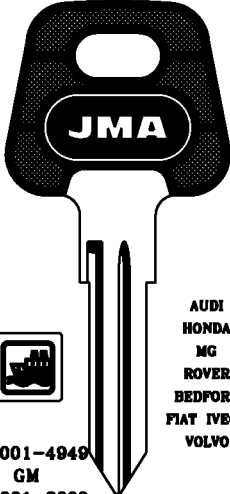
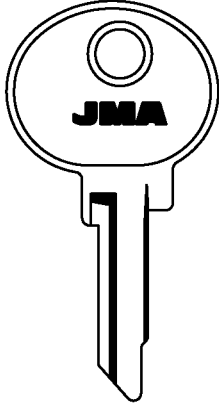
<b>PARA: FOR:</b>	<b>NEIMAN</b>			
				
41-4/4 RENAULT	....2001-4949 GM ....2001-3000 NE-1 CLAUSOR	AUDI HONDA MG ROVER BEDFORD FIAT IVECO VOLVO ....2001-4949 GM ....2001-3000 NE-1D NE-1.P CLAUSOR	AUDI HONDA MG ROVER BEDFORD FIAT IVECO VOLVO ....2001-4949 GM ....2001-3000 NE-1D.P CLAUSOR	S,T,X,Y Z,R 1-2-3-5-7 NE-2 CLAUSOR

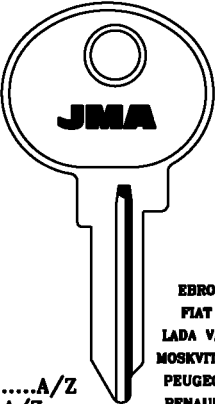
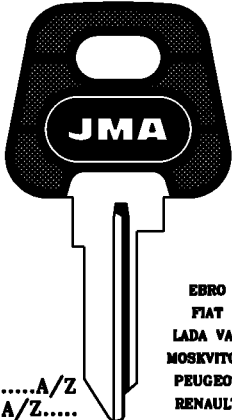
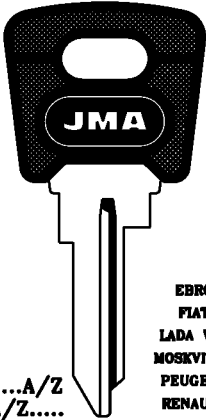
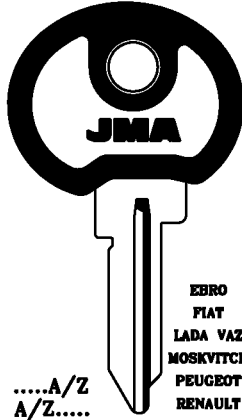
<b>PARA: FOR:</b>	<b>NEIMAN</b>			
				
.....A/Z A/Z..... A/Z.....A/Z 1 AL 7 .....A/Z 0 AL 9 NE-3 CLAUSOR	EBRO FIAT LADA VAZ MOSKVITCH PEUGEOT RENAULT TALBOT SIMCA ZAZ DAF VOLVO .....A/Z A/Z..... A/Z.....A/Z 1 AL 7 .....A/Z 0 AL 9 NE-3D NE-3.P CLAUSOR	EBRO FIAT LADA VAZ MOSKVITCH PEUGEOT RENAULT TALBOT SIMCA ZAZ DAF VOLVO .....A/Z A/Z..... A/Z.....A/Z 1 AL 7 .....A/Z 0 AL 9 NE-3.P1 CLAUSOR	EBRO FIAT LADA VAZ MOSKVITCH PEUGEOT RENAULT TALBOT SIMCA ZAZ DAF VOLVO .....A/Z A/Z..... A/Z.....A/Z 1 AL 7 .....A/Z 0 AL 9 NE-3.P2 CLAUSOR	

Copyright by  
Alejandro Altuna S.A.  
2005

**JMA**

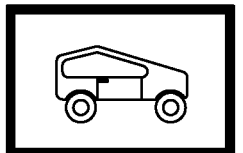

**169**

**PARA-FOR:**

**NEIMAN (F)**

**PARA:  
FOR:**

**NEIMAN**

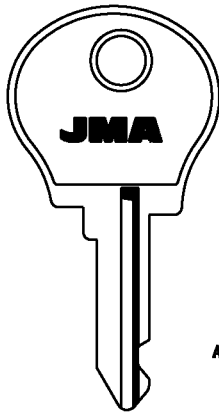

.A/Z.....  
.A/Z....A/Z  
A/Z....A/Z  
0 AL 8  
1 AL 7  
A/Z.....1 AL 7 Y A AL E

NE-4 NE-4D

11-34-39....  
1 AL 7  
34-39....A/Z  
1 AL 7

NE-15I NE-15D

ACM-ARO DACIA-CITROEN-PIAT-RENAULT  
CLAUSOR

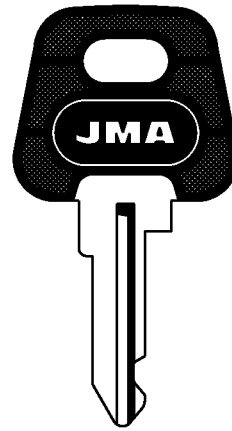

.A/Z.....  
.A/Z....A/Z  
A/Z....A/Z  
0 AL 8  
1 AL 7  
A/Z.....1 AL 7 Y A AL E

NE-4.P

11-34-39....  
1 AL 7  
34-39....A/Z  
1 AL 7

NE-15I.P NE-15D.P

ACM-ARO DACIA-CITROEN-PIAT-RENAULT  
CLAUSOR

**PARA:  
FOR:**

**NEIMAN**

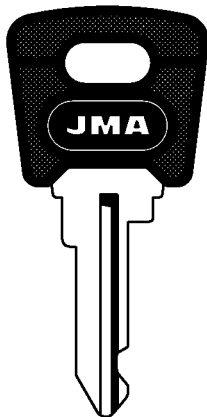

.A/Z.....  
.A/Z....A/Z  
A/Z....A/Z  
0 AL 8  
1 AL 7  
A/Z.....1 AL 7 Y A AL E

NE-4.P1

11-34-39....  
1 AL 7  
34-39....A/Z  
1 AL 7

NE-15I.P1 NE-15D.P1

ACM-ARO DACIA-CITROEN-PIAT-RENAULT  
CLAUSOR

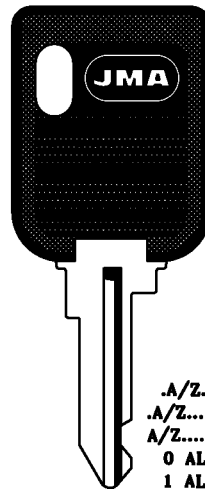

.A/Z.....  
.A/Z....A/Z  
A/Z....A/Z  
0 AL 8  
1 AL 7  
A/Z.....1 AL 7 Y A AL E

NE-4.P2

RENAULT  
CLAUSOR

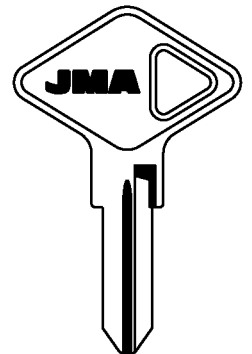

NE-5

CLAUSOR

**PARA:  
FOR:**

**NEIMAN**

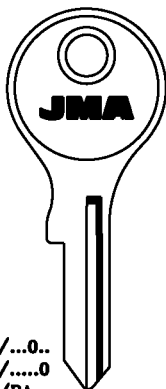

.0..../...0..  
....0./....0  
AA..../BA....  
CA..../EA....  
Z..../Z....  
...Z..../...Z..  
....Z./....Z  
1 AL 5

NE-6

VARIAS MARCAS DE MOTOS

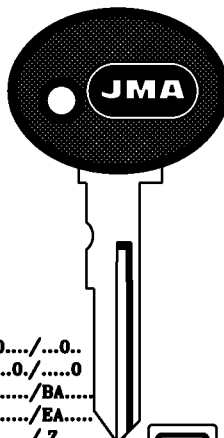

.0..../...0..  
....0./....0  
AA..../BA....  
CA..../EA....  
Z..../Z....  
...Z..../...Z..  
....Z./....Z  
1 AL 5

NE-6.P

VARIAS MARCAS DE MOTOS

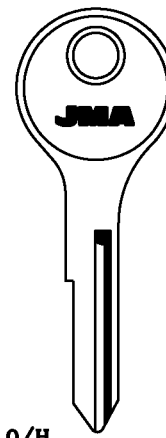

....0/H....  
.H..../..H...  
...H../....H.  
1 AL 5

NE-7

BMW

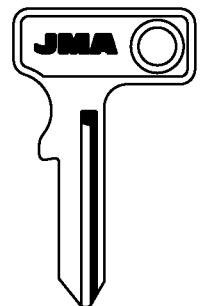

.0..../...0..  
....0/0....0  
AA..../BA....  
CA....  
1 AL 5

NE-8

VARIAS MARCAS DE MOTOS  
CLAUSOR

Copyright by  
Alejandro Altuna S.A.  
2005

**JMA**

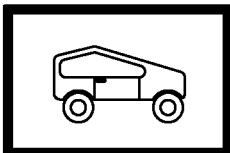

**170**

ATENCION:Concerniente a las marcas y denominaciones comerciales ver nota en indice.ATTENTION:Concerning the marks and commercial denominations see note in Index.  
ATTENTION:Concernant les marques et denominations commerciales voir la note dans l'Index.ACHTUNG:Beziehen auf die marke und handelsname sehen sie die notiz im Index.

PARA:  
FOR:

NEIMAN

PARA-FOR:

NEIMAN (F)

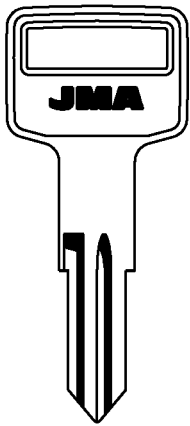

....6250-6499



NE-9

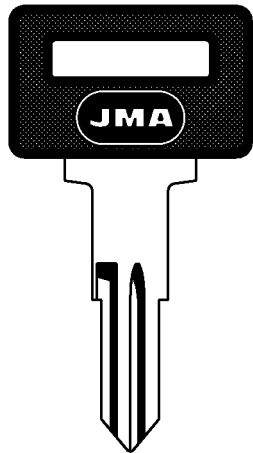

....6250-6499



NE-9.P

VOLVO  
CLAUSOR

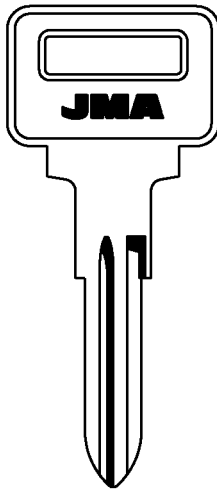

....7001-9000



NE-10

DE LOREAN-MG-VOLVO-BEDFORD

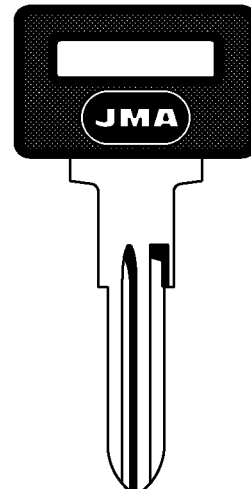

....7001-9000



NE-10.P

PARA:  
FOR:

NEIMAN

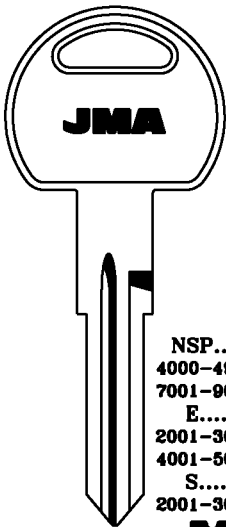

NSP....  
4000-4999  
7001-9000  
E....  
2001-3000  
4001-5000  
S....  
2001-3000

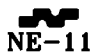

NE-11

FORD-NISSAN-ROVER-STERLING  
DAF-KENWORTH

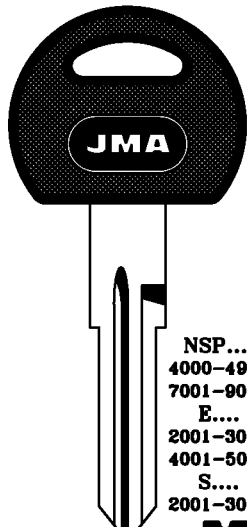

NSP....  
4000-4999  
7001-9000  
E....  
2001-3000  
4001-5000  
S....  
2001-3000



NE-11.P

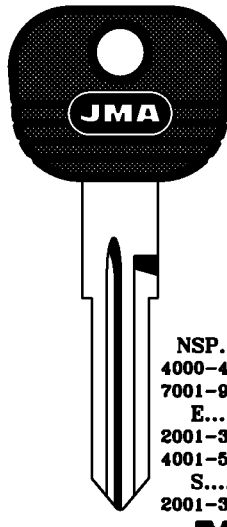

NSP....  
4000-4999  
7001-9000  
E....  
2001-3000  
4001-5000  
S....  
2001-3000

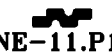

NE-11.P1

LAND RANGE ROVER-ROVER

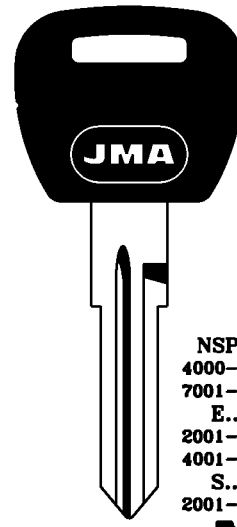

NSP....  
4000-4999  
7001-9000  
E....  
2001-3000  
4001-5000  
S....  
2001-3000



NE-11.P2

ROVER

PARA:  
FOR:

NEIMAN

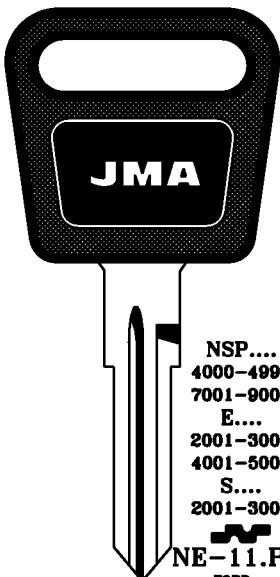

NSP....  
4000-4999  
7001-9000  
E....  
2001-3000  
4001-5000  
S....  
2001-3000

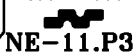

NE-11.P3

FORD

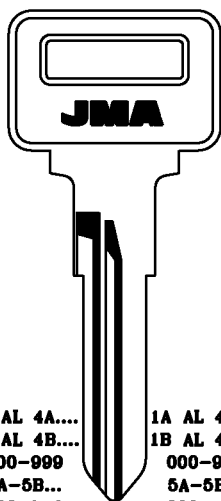

1A AL 4A....  
1B AL 4B....  
000-999  
5A-5B...  
000-746



NE-12

VOLVO

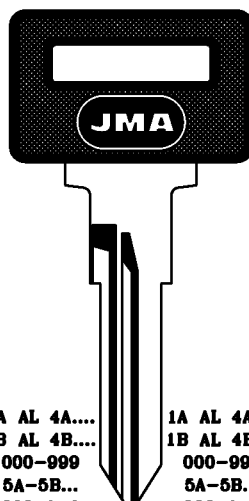

1A AL 4A....  
1B AL 4B....  
000-999  
5A-5B...  
000-746



NE-12.P

VOLVO

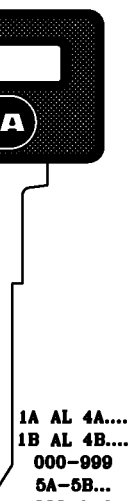

1A AL 4A....  
1B AL 4B....  
000-999  
5A-5B...  
000-746



NE-18.P

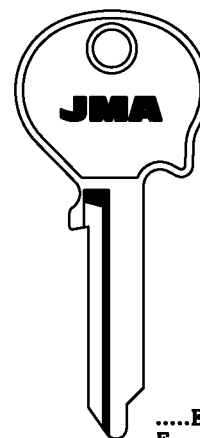

.....E  
E....  
N....  
X....  
1 AL 5



NE-13

VOLVO

Copyright by  
Alejandro Aituna S.A.  
2005

JMA

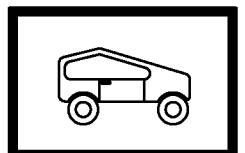

171

**PARA-FOR:**

**NEIMAN (F)**

**PARA:  
FOR:**

**NEIMAN**

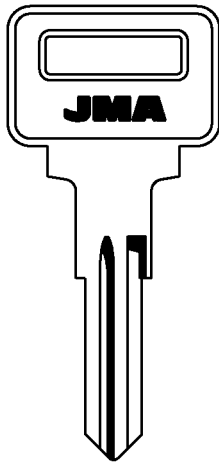

NP....  
1-1000  
  
**NE-14**  
ROVER  
CEM

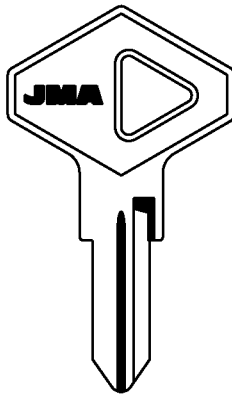

T...001-999  
V...000-922  
2.....  
2.....A/Z  
B-C-D-E-G  
  
**NE-16**  
AMERICAN MOTORS-RENAULT  
CLAUSOR

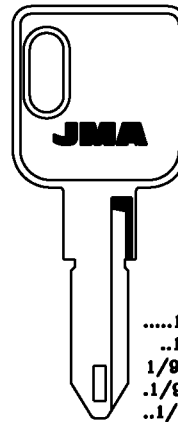

.....1/9.A/Z  
..1/9....  
1/9.....A/Z  
.1/9.....A/Z  
..1/9....A/Z  
...1/9...A/Z  
....1/9..A/Z  
.....1/9..A/Z A/Z  
M-N-P-R-S  
  
**NE-19**  
AMERICAN MOTORS-CHRYSLER-PEUGEOT  
RENAULT

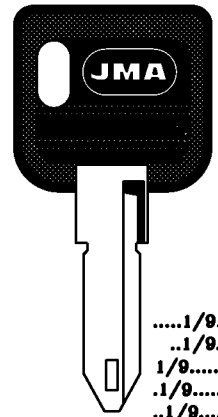

.....1/9.A/Z  
..1/9....  
1/9.....A/Z  
.1/9.....A/Z  
..1/9....A/Z  
...1/9...A/Z  
....1/9..A/Z  
.....1/9..A/Z A/Z  
M-N-P-R-S  
  
**NE-19.P**

**PARA:  
FOR:**

**NEIMAN**

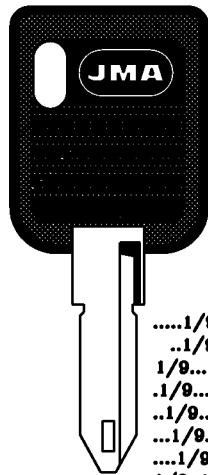

.....1/9.A/Z  
..1/9....  
1/9.....A/Z  
.1/9.....A/Z  
..1/9....A/Z  
...1/9...A/Z  
....1/9..A/Z  
.....1/9..A/Z A/Z  
M-N-P-R-S  
  
**NE-19.P1**  
RENAULT

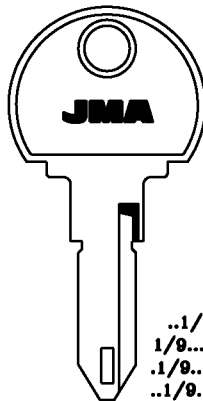

..1/9....  
1/9.....A/Z  
.1/9.....A/Z  
..1/9....A/Z  
...1/9...A/Z  
....1/9..A/Z  
.....1/9..A/Z A/Z  
M-N-P-R-S  
  
**NE-20**  
PEUGEOT

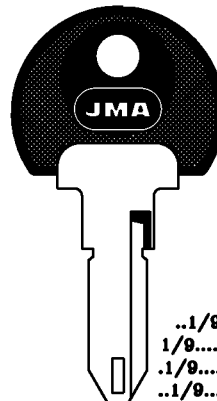

..1/9....  
1/9.....A/Z  
.1/9.....A/Z  
..1/9....A/Z  
...1/9...A/Z  
....1/9..A/Z  
.....1/9..A/Z A/Z  
M-N-P-R-S  
  
**NE-20.P**  
PEUGEOT

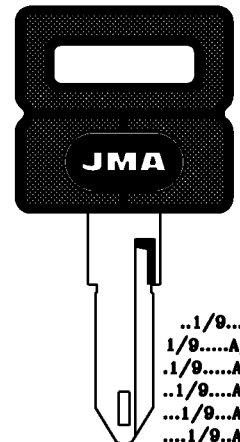

..1/9....  
1/9.....A/Z  
.1/9.....A/Z  
..1/9....A/Z  
...1/9...A/Z  
....1/9..A/Z  
.....1/9..A/Z A/Z  
M-N-P-R-S  
  
**NE-20.P1**  
PEUGEOT

**PARA:  
FOR:**

**NEIMAN**

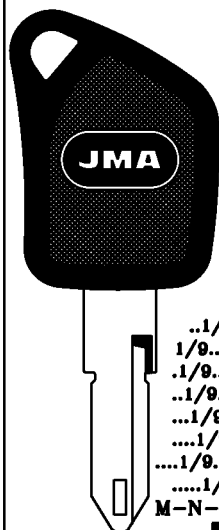

..1/9....  
1/9.....A/Z  
.1/9.....A/Z  
..1/9....A/Z  
...1/9...A/Z  
....1/9..A/Z  
.....1/9..A/Z A/Z  
M-N-P-R-S  
  
**NE-20.P2**  
PEUGEOT

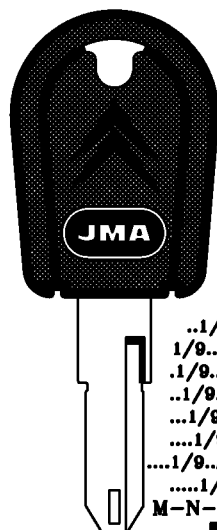

..1/9....  
1/9.....A/Z  
.1/9.....A/Z  
..1/9....A/Z  
...1/9...A/Z  
....1/9..A/Z  
.....1/9..A/Z A/Z  
M-N-P-R-S  
  
**NE-20.P3**  
CITROEN

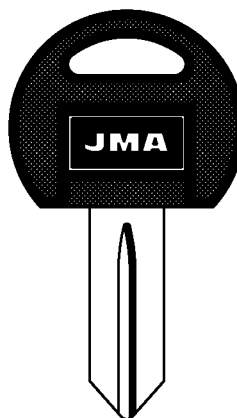

  
**NE-21.P**  
VOLVO  
FASTEX

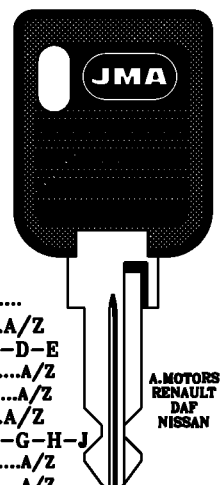

.....  
.....A/Z  
B-C-D-E  
1/9.....A/Z  
1/9.....A/Z  
.....A/Z  
B-D-E-G-H-J  
.1/9.....A/Z  
.1/9.....A/Z  
E-M-N-P-R  
  
**NE-22.P**  
CLAUSOR  
A.MOTORS  
RENAULT  
DAF  
NISSAN

Copyright by  
Alejandro Altuna S.A.  
2005

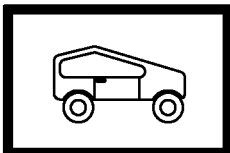

**172**

PARA:  
FOR:

### NEIMAN

PARA-FOR:

NEIMAN (F)

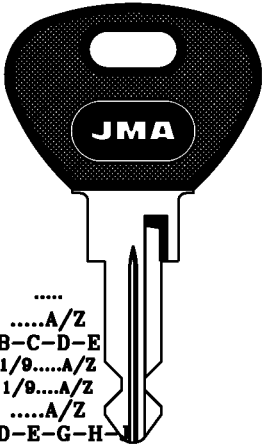

.....  
.....A/Z  
B-C-D-E  
1/9.....A/Z  
1/9.....A/Z  
.....A/Z  
B-D-E-G-H-J  
.1/9.....A/Z  
.1/9.....A/Z  
E-M-N-P-R

**NE-22.P1**  
CITROEN-PEUGEOT-PEGASO  
CLAUSOR

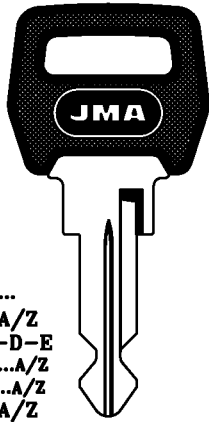

.....  
.....A/Z  
B-C-D-E  
1/9.....A/Z  
1/9.....A/Z  
.....A/Z  
B-D-E-G-H-J  
.1/9.....A/Z  
.1/9.....A/Z  
E-M-N-P-R

**NE-22.P2**  
MAZDA-TALBOT SIMCA-DAF  
CLAUSOR

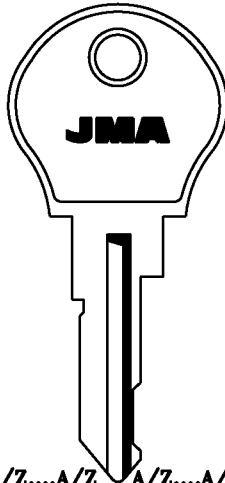

A/Z.....A/Z A/Z.....A/Z  
0-4-6-8-9 0-4-6-8-9

**NE-23** **NE-26**  
MAZDA  
DATSUN

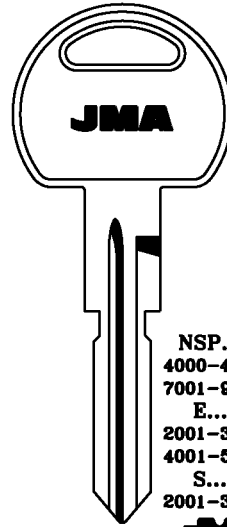

NSP....  
4000-4999  
7001-9000  
E....  
2001-3000  
4001-5000  
S....  
2001-3000

**NE-24**  
FORD-ROVER-STERLING

PARA:  
FOR:

### NEIMAN

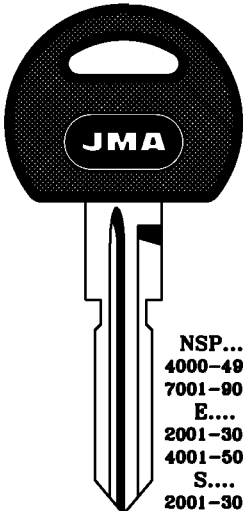

NSP....  
4000-4999  
7001-9000  
E....  
2001-3000  
4001-5000  
S....  
2001-3000

**NE-24.P**  
FORD-ROVER-STERLING

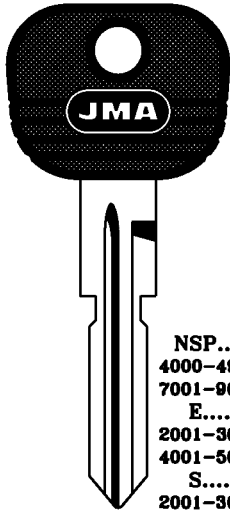

NSP....  
4000-4999  
7001-9000  
E....  
2001-3000  
4001-5000  
S....  
2001-3000

**NE-24.P1**  
LAND RANGE ROVER-ROVER

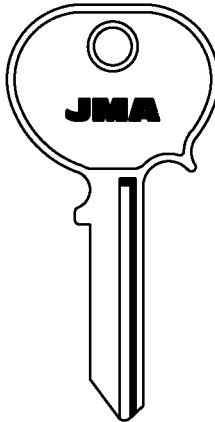

.....A  
.....D  
.....F  
1 AL 5

**NE-25**  
ALFA ROMEO-FERRARI-STEYR PUCH

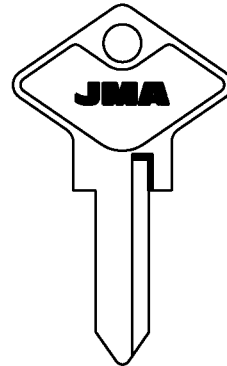

**NE-27**

PARA:  
FOR:

### NEIMAN

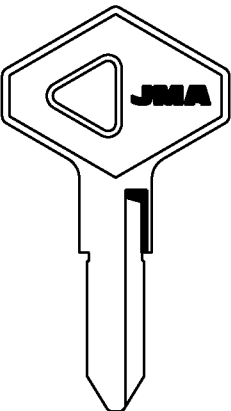

..1/9...A/Z  
M-N-P-R-S

**NE-28**  
CHRYSLER (EAGLE)-RENAULT

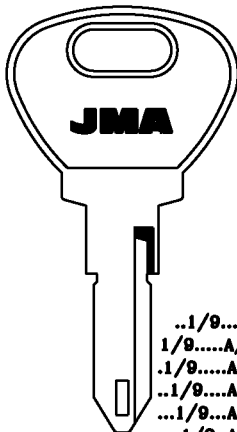

..1/9...  
1/9.....A/Z  
.1/9.....A/Z  
..1/9.....A/Z  
...1/9...A/Z  
....1/9..A/Z  
....1/9..A/Z A/Z  
.....1/9..A/Z  
M-N-P-R-S

**NE-29**  
PEUGEOT

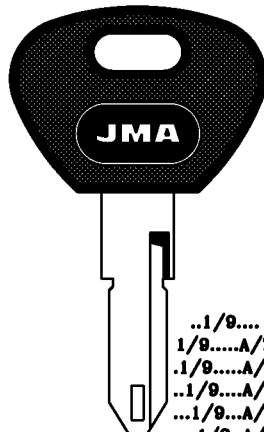

..1/9...  
1/9.....A/Z  
.1/9.....A/Z  
..1/9.....A/Z  
...1/9...A/Z  
....1/9..A/Z  
....1/9..A/Z A/Z  
.....1/9..A/Z  
M-N-P-R-S

**NE-29.P**  
PEUGEOT



....  
5001-8278

**NE-30**  
BASTA

Copyright by  
Alejandro Altuna S.A.  
2005

**JMA**

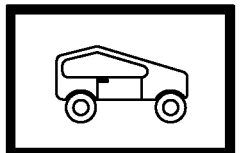







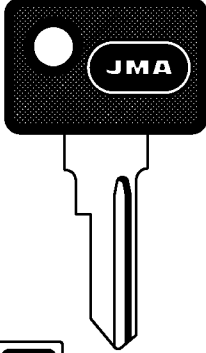

**173**

**PARA-FOR:**

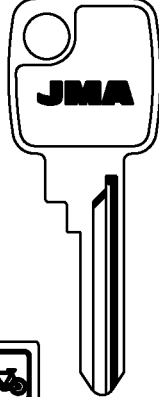
**NEIMAN (F)**

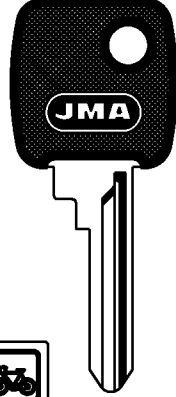

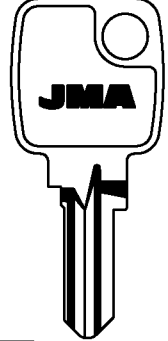
**PARA:  
FOR:**

**NEIMAN**

  <p>.... 5001-6278 NE-30.P</p> <p>BASTA</p>	  <p>..1/9....A/Z M-N-P-R-S NE-31</p> <p>BASTA</p>	  <p>..1/9....A/Z M-N-P-R-S NE-31.P</p> <p>BASTA</p>	  <p>.B...3-5-7-L ..B...3-5-7-L/2-3-5-7-L ...B...3-5-7-L ....B.3-5-7-L NE-32</p> <p>BASTA</p>
--	--	--	---

**PARA:  
FOR:**

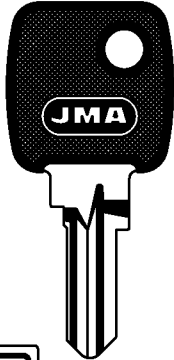
**NEIMAN**

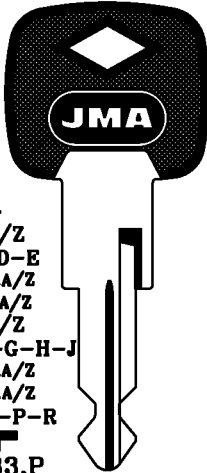
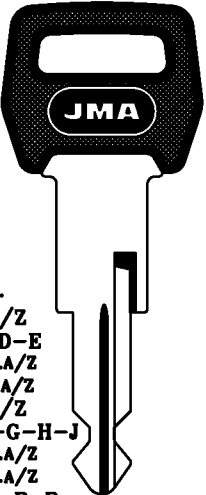
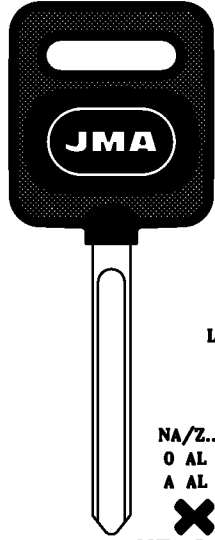
  <p>.B...3-5-7-L ..B...3-5-7-L/2-3-5-7-L ...B...3-5-7-L ....B.3-5-7-L NE-32.P</p> <p>BASTA</p>	 <p>.... ....A/Z B-C-D-E 1/9....A/Z 1/9....A/Z ....A/Z B-D-E-G-H-J .1/9....A/Z .1/9....A/Z E-M-N-P-R NE-33.P</p> <p>RENAULT CLAUSOR</p>	 <p>.... ....A/Z B-C-D-E 1/9....A/Z 1/9....A/Z ....A/Z B-D-E-G-H-J .1/9....A/Z .1/9....A/Z E-M-N-P-R NE-33.P1</p> <p>TALBOT SIMCA CLAUSOR</p>	 <p>LAT. NA/Z..... O AL 9 A AL F NE-34.P</p> <p>PEUGEOT</p>
--	--	--	--

**PARA:  
FOR:**

**NEIMAN**

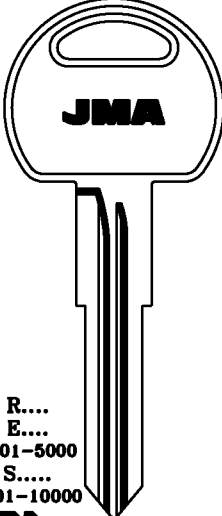
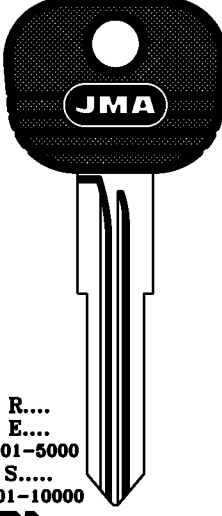
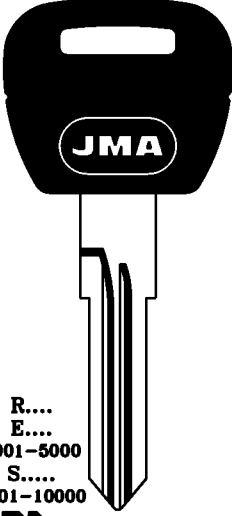
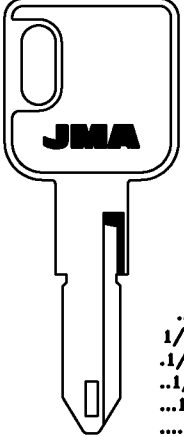
 <p>R.... E.... 4001-5000 S..... 8001-10000 NE-35</p> <p>HONDA-ROVER</p>	 <p>R.... E.... 4001-5000 S..... 8001-10000 NE-35.P</p> <p>ROVER</p>	 <p>R.... E.... 4001-5000 S..... 8001-10000 NE-35.P2</p> <p>HONDA-ROVER</p>	 <p>..1/9.... 1/9....A/Z .1/9....A/Z ..1/9....A/Z ...1/9....A/Z ....1/9....A/Z ....1/9.A/Z A/Z ....1/9.A/Z M-N-P-R-S NE-36</p> <p>CITROEN-PEUGEOT-RENAULT</p>
--	--	--	---

Copyright by  
Alejandro Altuna S.A.  
2005

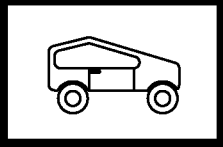
**174**

PARA:  
FOR:

### NEIMAN

PARA-FOR:

NEIMAN (F)

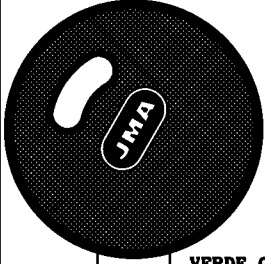

VERDE O NEGRO

..1/9....  
1/9.....A/Z  
.1/9.....A/Z  
..1/9.....A/Z  
...1/9.....A/Z  
....1/9.....A/Z  
.....1/9.A/Z A/Z  
.....1/9.A/Z  
M-N-P-R-S

**NE-36.P**  
RENAULT

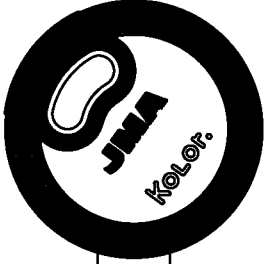

..1/9....  
1/9.....A/Z  
.1/9.....A/Z  
..1/9.....A/Z  
...1/9.....A/Z  
....1/9.....A/Z  
.....1/9.A/Z A/Z  
.....1/9.A/Z  
M-N-P-R-S

**NE-36K.P**  
RENAULT

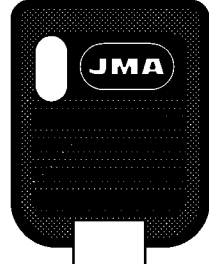

..1/9....  
1/9.....A/Z  
.1/9.....A/Z  
..1/9.....A/Z  
...1/9.....A/Z  
....1/9.....A/Z  
.....1/9.A/Z A/Z  
.....1/9.A/Z  
M-N-P-R-S

**NE-36.P1**  
CITROEN-PEUGEOT-RENAULT

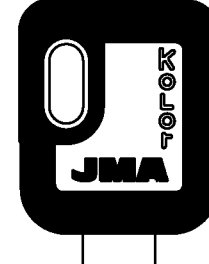

..1/9....  
1/9.....A/Z  
.1/9.....A/Z  
..1/9.....A/Z  
...1/9.....A/Z  
....1/9.....A/Z  
.....1/9.A/Z A/Z  
.....1/9.A/Z  
M-N-P-R-S

**NE-36K.P1**  
CITROEN-PEUGEOT-RENAULT

PARA:  
FOR:

### NEIMAN

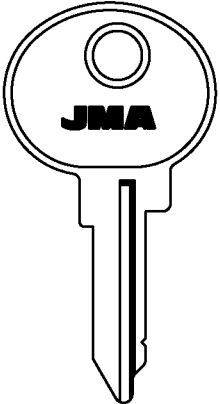

.....A/Z  
1-2-3-5-7

**NE-37**  
PEUGEOT

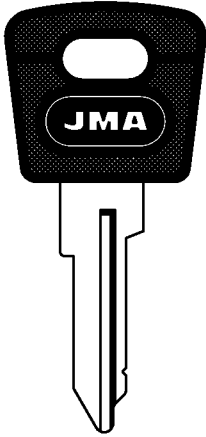

.....A/Z  
1-2-3-5-7

**NE-37.P**  
PEUGEOT

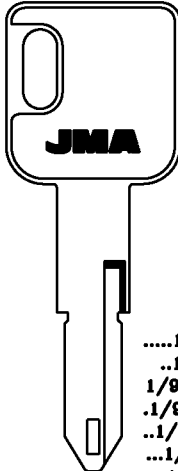

.....1/9.A/Z  
..1/9....  
1/9.....A/Z  
.1/9.....A/Z  
..1/9.....A/Z  
...1/9.....A/Z  
....1/9.....A/Z  
.....1/9.A/Z A/Z

**NE-38**  
RENAULT

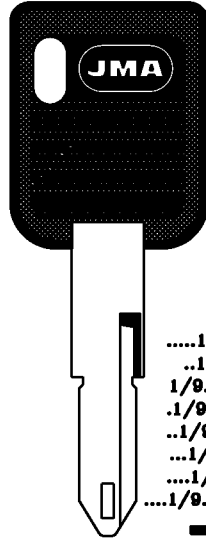

.....1/9.A/Z  
..1/9....  
1/9.....A/Z  
.1/9.....A/Z  
..1/9.....A/Z  
...1/9.....A/Z  
....1/9.....A/Z  
.....1/9.A/Z A/Z

**NE-38.P1**  
RENAULT

PARA:  
FOR:

### NEIMAN



..1/9....  
1/9.....A/Z  
.1/9.....A/Z  
..1/9.....A/Z  
...1/9.....A/Z  
....1/9.....A/Z  
.....1/9.A/Z A/Z  
.....1/9.A/Z  
M-N-P-R-S

**NE-39.P**  
PEUGEOT

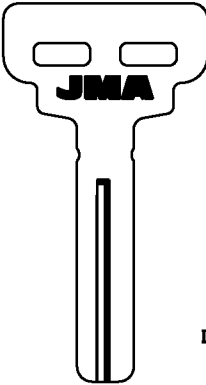

LAT.

7,5  
3

**NE-40**  
VOLVO  
YMOS

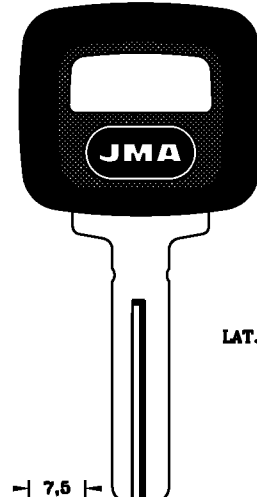

LAT.

7,5  
3

**NE-40.P**  
VOLVO  
YMOS

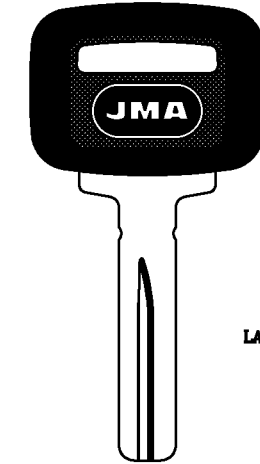

LAT.

7,5  
3

**NE-41.P1**  
VOLVO  
YMOS

Copyright by  
Alejandro Altuna S.A.  
2005

# JMA

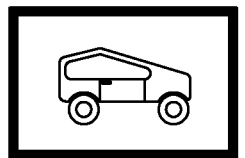

# 175

**PARA-FOR:**

**NEIMAN  
(F-RA)**

**PARA:  
FOR:**

**NEIMAN**

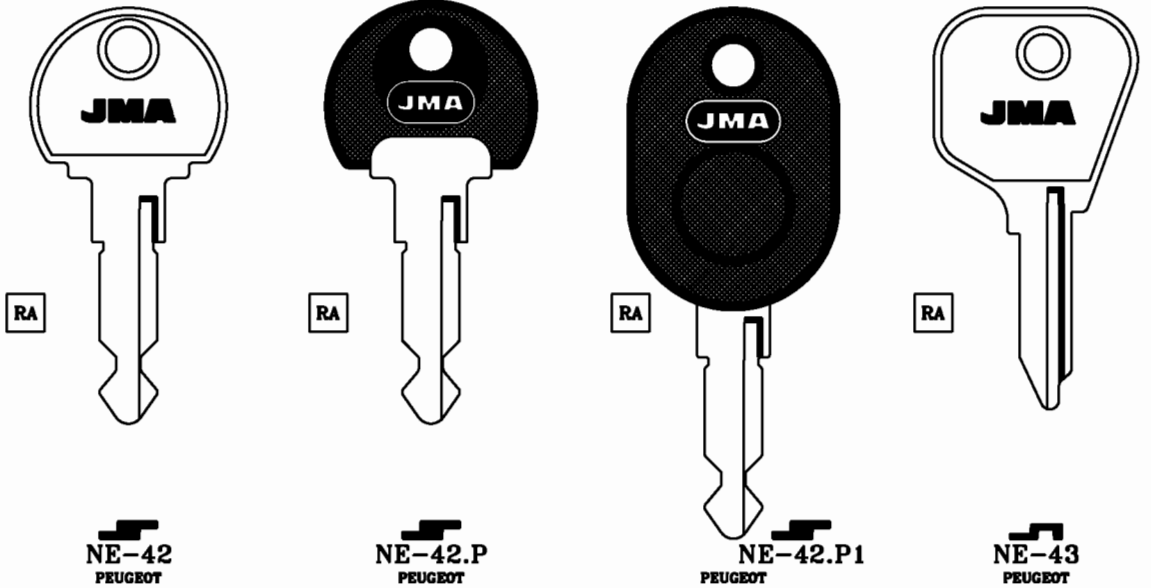

**PARA:  
FOR:**

**NEIMAN**

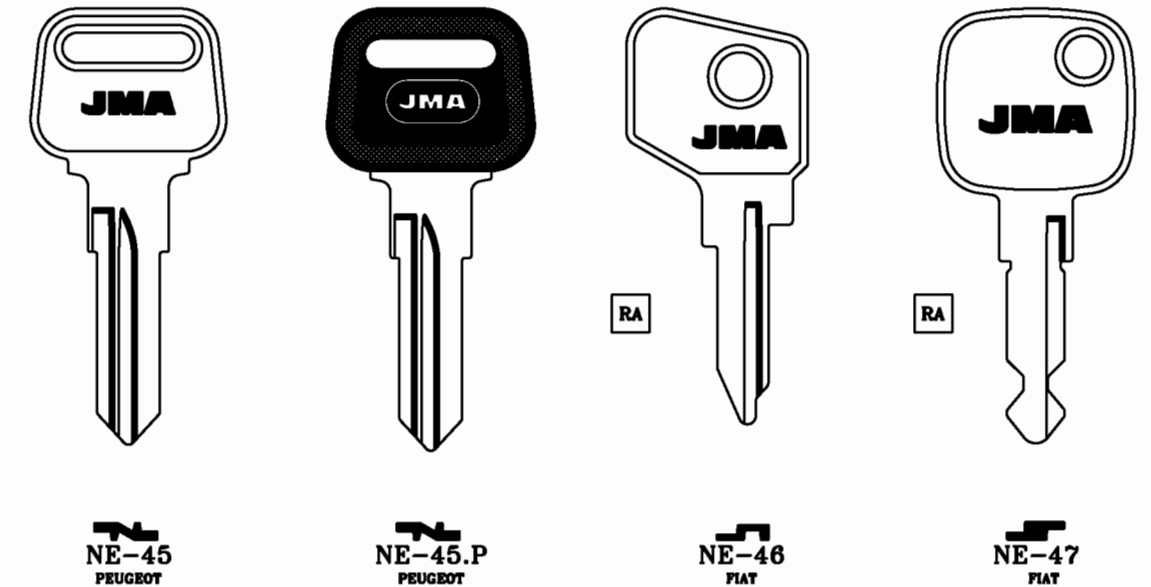

**PARA:  
FOR:**

**NEIMAN**

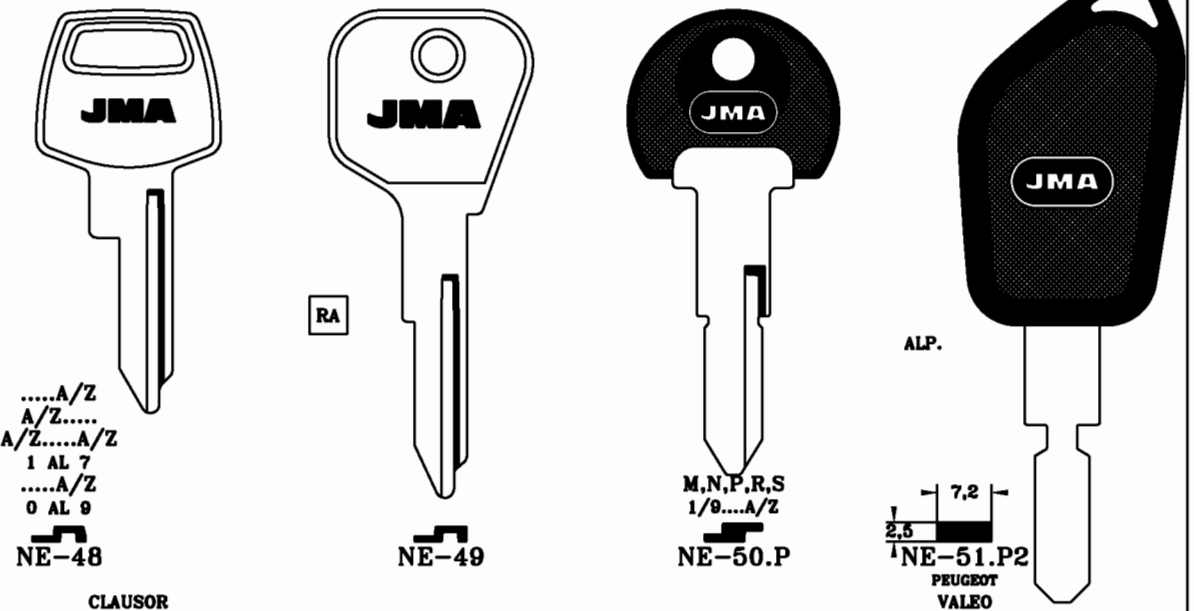

Copyright by  
Alejandro Altuna S.A.  
2005

**JMA**

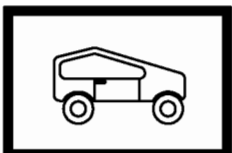

**176**

.....A/Z  
A/Z.....  
A/Z.....A/Z  
1 AL 7  
.....A/Z  
0 AL 9  
NE-48

CLAUSOR

NE-49

M,N,P,R,S  
1/9...A/Z  
NE-50.P

ALP.  
2.5 7.2  
NE-51.P2  
PEUGEOT  
VALEO

PARA:  
FOR:

### NEIMAN

**PARA-FOR:**

**NEIMAN  
(F-RA)**

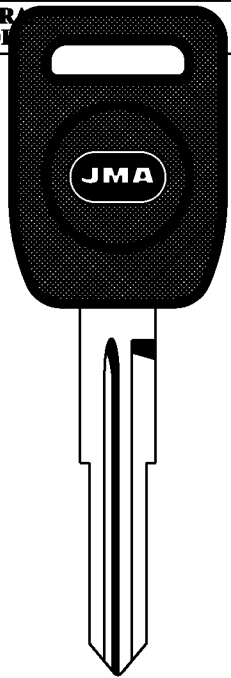

L....  
8001-10000  
  
NE-52.P  
ROVER

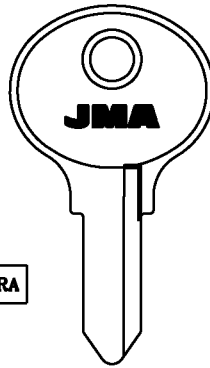

RA

NE-53

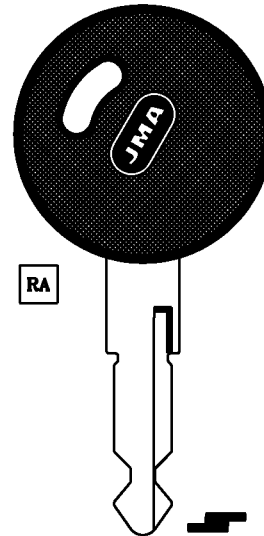

RA

NE-54.P  
RENAULT

PARA:  
FOR:

### NEIMAN

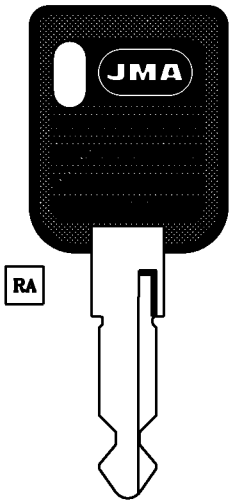

RA

NE-55.P  
RENAULT

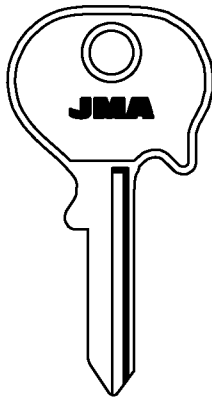

.....  
1 AL 5  
  
NE-56

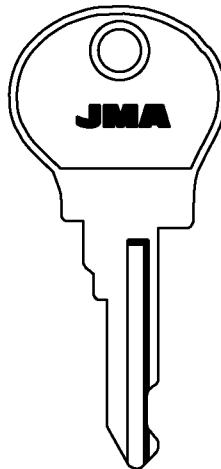

NE-57  
MAZDA

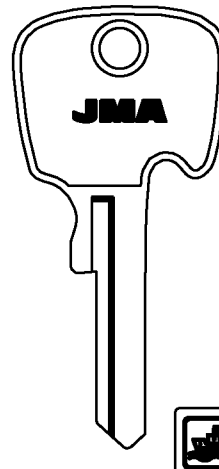

N....1 AL 5  
  
NE-58D

BOMORO-BOSCH

PARA:  
FOR:

### NEIMAN

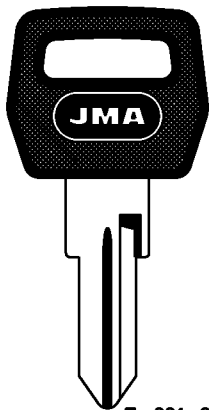

T...001-999  
V...000-922  
2.....  
2.....A/Z  
B-C-D-E-G  
  
NE-59.P

CLAUSOR



..1/9....  
1/9....A/Z  
.1/9....A/Z  
..1/9....A/Z  
...1/9....A/Z  
....1/9....A/Z  
.....1/9..A/Z A/Z  
.....1/9.A/Z  
M-N-P-R-S

NE-60C1

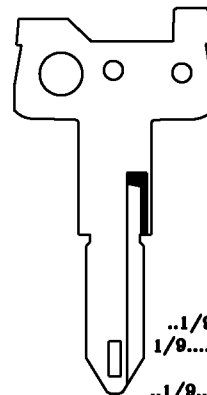

..1/9....  
1/9....A/Z  
..1/9....A/Z  
...1/9....A/Z  
....1/9....A/Z  
.....1/9..A/Z A/Z  
.....1/9.A/Z  
M-N-P-R-S

NE-60C2

Copyright by  
Alejandro Altuna S.A.  
2005

**JMA**

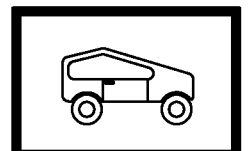

**177**

**PARA-FOR:**

**NISSAN (J)**

**PARA:** NISSAN  
**FOR:**

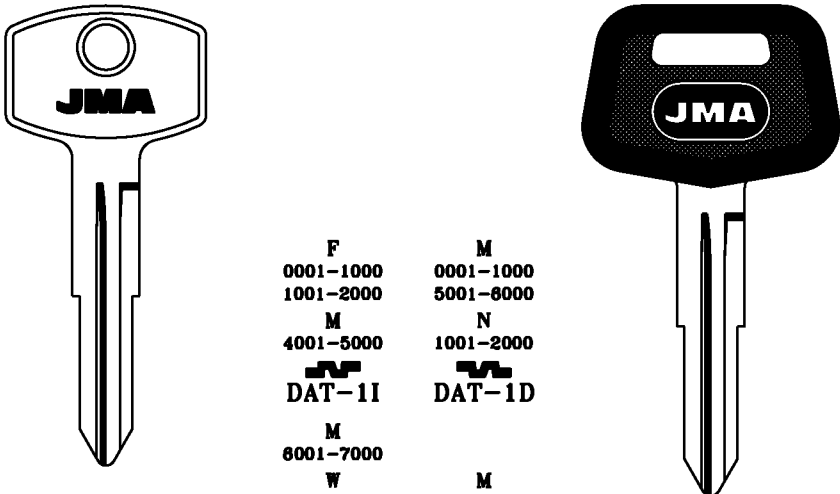

F 0001-1000 1001-2000	M 0001-1000 5001-6000	F 0001-1000 1001-2000	M 0001-1000 5001-6000
M 4001-5000	N 1001-2000	M 4001-5000	N 1001-2000
 DAT-1I	 DAT-1D	 DAT-1I.P	 DAT-1D.P
M 8001-7000		M 8001-7000	
W 0001-1000	M 7001-8000	W 0001-1000	M 7001-8000
 DAT-2I	 DAT-2D	 DAT-2I.P	 DAT-2D.P
NISSAN-SUBARU DATSUN-WASO		NISSAN-SUBARU DATSUN-WASO	

**PARA:** NISSAN  
**FOR:**

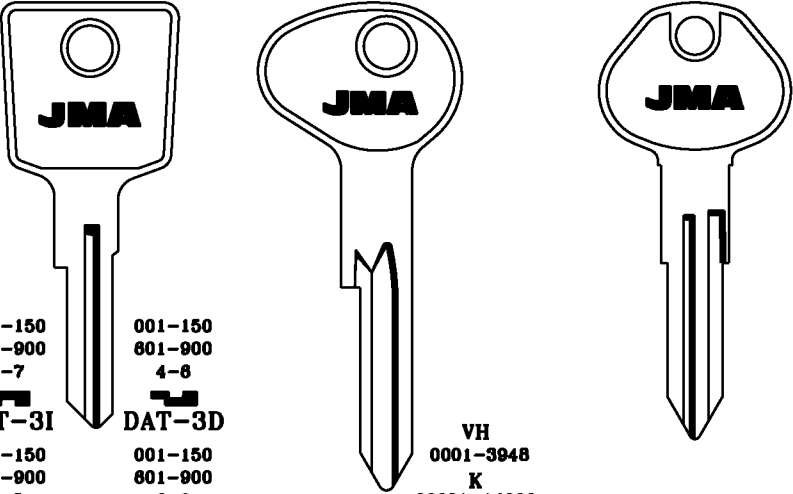

001-150 601-900 3-7  DAT-3I	001-150 601-900 4-8  DAT-3D	VH 0001-3948 K 00001-14000  DAT-5D	X 0001-8000  DAT-6	 DAT-6D
001-150 601-900 1-5  DAT-4I	001-150 601-900 6-9  DAT-4D	NISSAN DATSUN-WASO	Y 0001-8000 8001-9000  DAT-7	ALFA ROMEO-DELTA-EBRO-GMC-INFINITI-NISSAN-SUBARU DATSUN
MAZDA-NISSAN-SUBARU DATSUN				

**PARA:** NISSAN  
**FOR:**

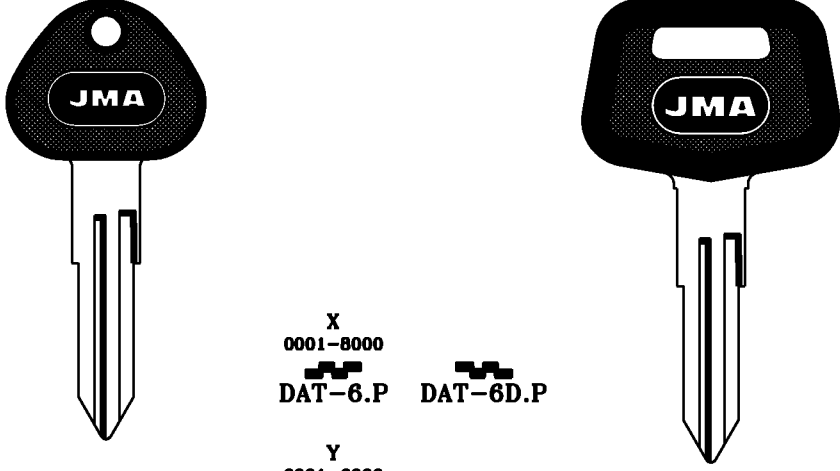

X 0001-8000  DAT-6.P	 DAT-6D.P	X 0001-8000  DAT-6.P1	 DAT-6D.P1
Y 0001-8000 8001-9000  DAT-7.P		Y 0001-8000 8001-9000  DAT-7.P1	
ALFA ROMEO-DELTA-EBRO-GMC-INFINITI-NISSAN-SUBARU DATSUN		INFINITI-NISSAN-SUBARU DATSUN	

Copyright by  
Alejandro Altuna S.A.  
2005

**JMA**

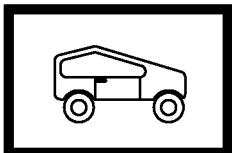

**178**

PARA:  
FOR:

# NISSAN

PARA-FOR:

NISSAN (J)

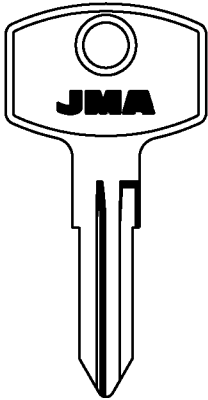

F  
0001-1000  
1001-2000  
M  
4001-5000  
DAT-8I

M  
0001-1000  
5001-6000  
N  
1001-2000  
DAT-8

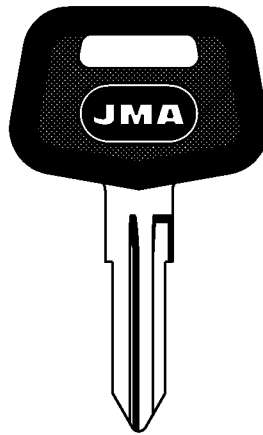

F  
0001-1000  
1001-2000  
M  
4001-5000  
DAT-8I.P

M  
0001-1000  
5001-6000  
N  
1001-2000  
DAT-8.P

M  
6001-7000  
7001-800  
W  
0001-1000  
DAT-9I

M  
7001-800  
DAT-9D

NISSAN-SUBARU  
DATSUN

M  
6001-7000  
7001-800  
W  
0001-1000  
DAT-9I.P

M  
7001-600  
DAT-9D.P

NISSAN-SUBARU  
DATSUN

PARA:  
FOR:

# NISSAN

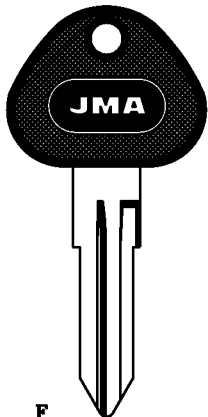

F  
0001-1000  
1001-2000  
M  
4001-5000  
DAT-8I.P1  
NISSAN-SUBARU  
DATSUN

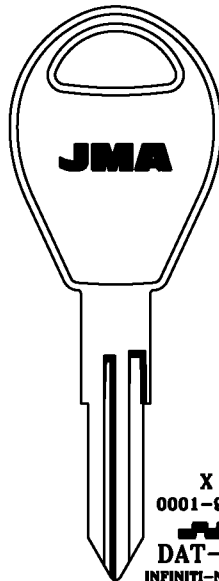

X  
0001-9000  
DAT-10  
INFINITI-NISSAN

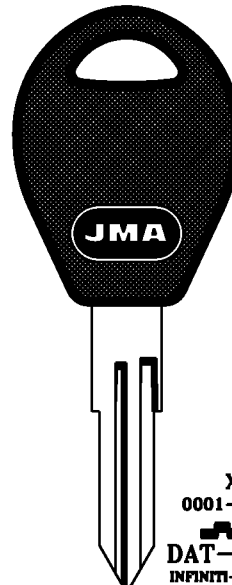

X  
0001-9000  
DAT-10.P  
INFINITI-NISSAN

PARA:  
FOR:

# NISSAN

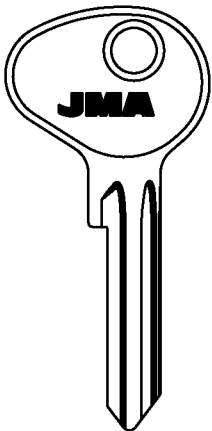

VH  
0001-3948  
K  
00001-14000  
DAT-11 DAT-11D  
MAZDA-SUBARU  
DATSUN-WASO

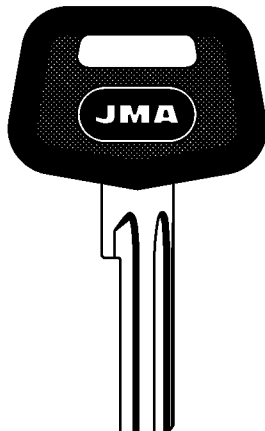

VH  
0001-3948  
K  
00001-14000  
DAT-11P DAT-11DP  
MAZDA-SUBARU  
DATSUN-WASO

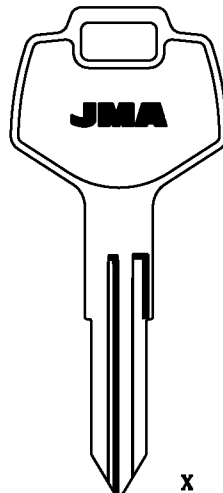

X  
0001-9000  
DAT-12  
HOLDEN-NISSAN

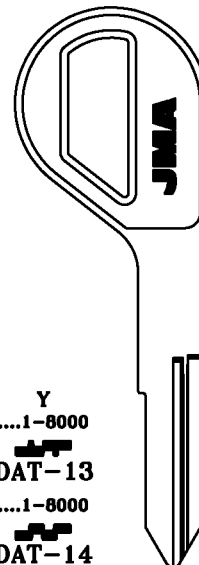

Y  
....1-8000  
DAT-13  
....1-8000  
DAT-14  
INFINITI

Copyright by  
Alejandro Altuna S.A.  
2005

# JMA

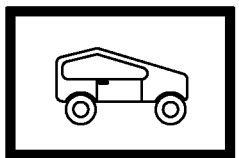

# 179

**PARA-FOR:**

**NISSAN (J)**

**PGO (J)**

**PJ (F)**

**PARA:** NISSAN  
**FOR:**

Y  
....1-8000  
DAT-13.P  
....1-8000  
DAT-14.P  
INFINITI

1-22185  
DAT-15

1-22185  
DAT-15.P

1-22185  
DAT-16

**PARA:** NISSAN  
**FOR:**

LAT.

LAT.

A  
101-291  
501-579  
B  
101-332  
501-802  
C  
101-344  
501-824  
D  
101-327  
501-602  
E  
101-296  
501-579  
DAT-19

A  
101-291  
501-579  
B  
101-332  
501-602  
C  
101-344  
501-824  
D  
101-327  
501-602  
E  
101-296  
501-579  
DAT-19.P

**PARA:** NISSAN  
**FOR:**

....X  
0001-1706  
DAT-20

....X  
0001-1706  
DAT-20.P

**PGO**

PGO-1

**PJ**

J...  
001-224  
PJ-1  
DAF-RENAULT-TALBOT S.-VOLKSWAGEN  
KIFERM

Copyright by  
Alejandro Altuna S.A.  
2005

**JMA**

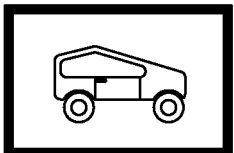

**180**

PARA:  
FOR:

PJ

PARA-FOR:

PJ (F)

POLLAK (USA)

POS (D)

PRESTA (D)

RONIS (F)

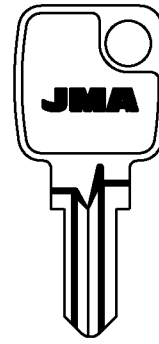
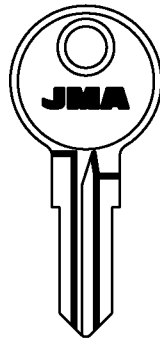
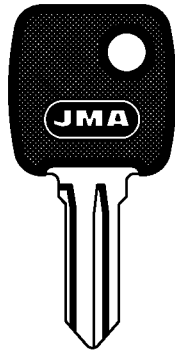
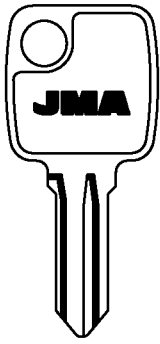

J...  
001-224  
PJ-2  
KIFERM



J...  
001-224  
PJ-2.P  
KIFERM



K...4-8-8  
K...4-8-8-A-B-C  
G..01-99  
PJ-3  
TALBOT SIMCA



K...4-8-8  
K...4-8-8-A-B-C  
PJ-K

PARA:  
FOR:

PJ

POLLAK

POS

PRESTA

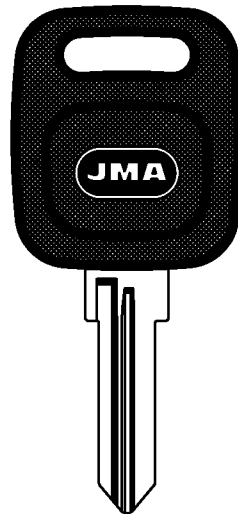
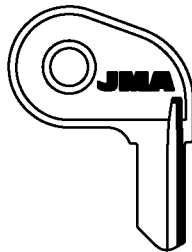
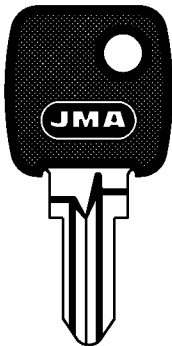

K...4-8-8  
K...4-8-8-A-B-C  
PJ-K.P



PLL-1  
ERINRUDE

POS-1D.P  
SISPA

....  
1001-1052  
....  
7200-7399  
PRE-1I



PRE-3  
FIAT IVECO-MAGIRUS DEUTZ  
LAPORTE

PARA:  
FOR:

PRESTA

RONIS

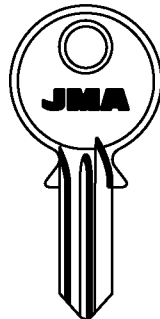
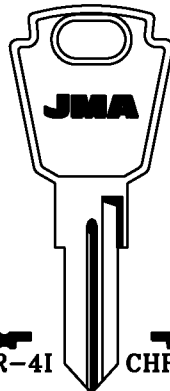
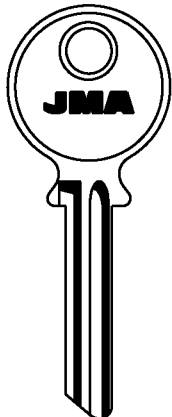

CHR-4I CHR-4D

RO-1IS RO-1DS  
C  
001-224  
RO-3

A8..AA-DS A9..AA-DS  
..8AB-ZZ ..8AB-ZZ  
S...385-402 S...403-420  
RO-1I RO-1D  
CITROEN-PEUGEOT-RENAULT-TALBOT  
ABSA-FROSER-PJ-SADV

..4AB-ZZ ..3AB-ZZ  
S...331-348 ....1 AL 4  
RO-2I RO-2D  
AA-JZ AA-JZ  
A4../A.4. S...213-248  
RO-4I RO-4D  
AB-ZZ AB-ZZ  
..6 ..7  
S...349-388 S...387-384  
RO-6I RO-6D

....7700-7749  
PRE-2I  
LAPORTE

Copyright by  
Alejandro Altuna S.A.  
2005

JMA

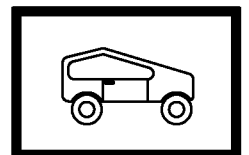

181

**PARA-FOR:**

**RONIS (F)**

**ROSS (E)**

**SAAB (S)**

**PARA:  
FOR:**

**RONIS**

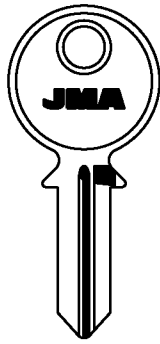

ARMOR  
EMHART  
FORINDEX  
KARDEX  
MLM  
NEMEF  
RONEO  
SANEL STRAFOR  
SCHAFFER  
YAC

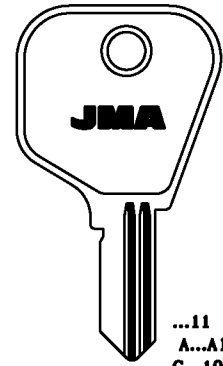

C4..AA-ZY  
D4..AA-HR  
RO-5I  
CITROEN-PEUGEOT  
ABS

...11 1-700  
A...A1-700  
C...101-600  
D...1-1000  
T...1-380  
...151-700  
E...1-1000  
T...107-400  
Y...101-600  
RO-7I

...151-700  
E...1-1000  
T...107-400  
Y...101-600  
RO-8I  
F...1-500  
RO-30  
RO-32D  
T...1-380  
TA...1-224  
GV...1-300  
...F1-500  
1F..1-21  
RO-8D  
RO-30D  
RO-33

...11 1-700  
A...A1-700  
C...101-600  
D...1-1000  
T...1-380  
TA...1-224  
GV...1-300  
...F1-500  
1F..1-21  
...151-700  
E...1-1000  
T...107-400  
Y...101-600  
RO-11I  
PEUGEOT-RENAULT  
ABS-SADV-SIMPLEX  
RO-11D

**PARA:  
FOR:**

**RONIS**

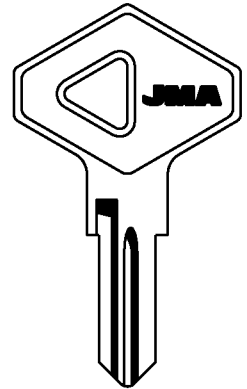
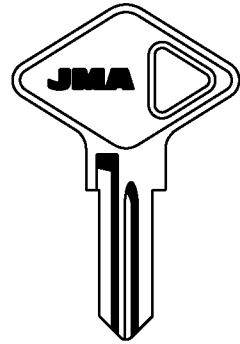
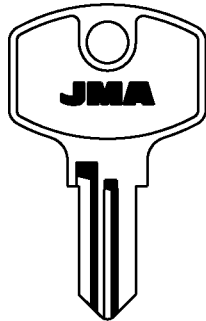
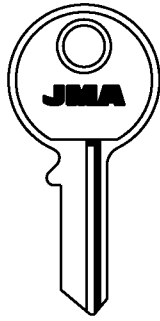

RO-12I RO-12D  
M...601-983 TAV  
RO-16I RO-16D  
BURG-STRAFOR

RO-14  
PEUGEOT

70.....  
1 AL 3  
...1-975  
RO-15  
ACN-ARO DACIA-RENAULT

77....  
0 AL 3  
RO-17  
RENAULT

**PARA:  
FOR:**

**ROSS**

**SAAB**

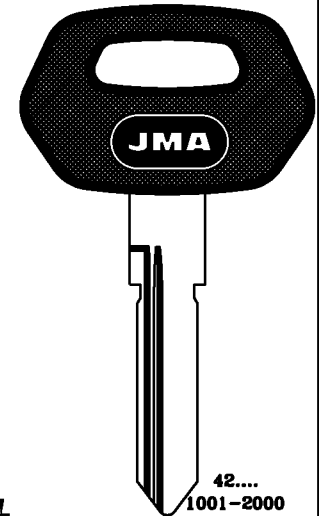
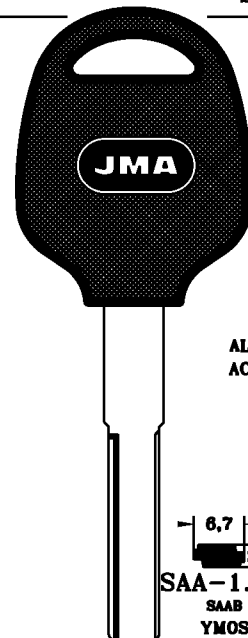
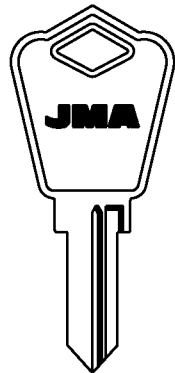
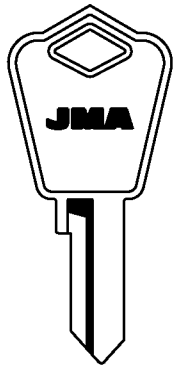

ROS-1D

ROS-2

ALP.  
ACE.  
6,7  
2,95  
SAA-1.P1  
SAAB  
YMOS

42....  
1001-2000  
SAA-2.P

Copyright by  
Alejandro Altuna S.A.  
2005

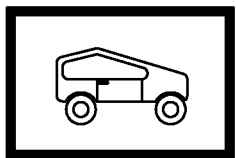

**182**

<b>PARA:</b> <b>FOR:</b>	<b>SAAB</b>	<b>PARA-FOR:</b>	<b>SAFE</b>
AC 1-3192 SAA-AC SAAB YMOS		AC 1-3192 SAA-AC.P SAAB YMOS	
		TRAMA-FIST	

<b>PARA:</b> <b>FOR:</b>	<b>SAFE</b>				
A 001-125 AF-1I ALFA ROMEO-AUTOBIANCHI SIPEA-MAGNETI MARELLI		B 001-125 AF-1D ALFA ROMEO-AUTOBIANCHI SIPEA-MAGNETI MARELLI		D 1-125 AF-2I ALFA ROMEO-AUTOBIANCHI SIPEA-MAGNETI MARELLI	
		C 1-125 AF-2D ALFA ROMEO-AUTOBIANCHI SIPEA-MAGNETI MARELLI			
				S 815-899 712-799 812-899 AF-4I ALFA ROMEO-FIAT FIST-TRAMA	
				D 115-199 212-299 312-399 AF-4D ALFA ROMEO-FIAT FIST-TRAMA	

<b>PARA:</b> <b>FOR:</b>	<b>SAFE</b>				
CROMODORA FIST FREA GIOBERT MIRAGLIO RUFFINI		1 100-789 AF-10		3 100-789 AF-11	
8 100-309 AF-5I		8 100-309 AF-5D		3 0501-1000 IMS-3	
2 100-309 AF-6I ALFA ROMEO-AUTOBIANCHI-FIAT		4 100-309 AF-6D		4 0501-1000 AF-21	
		5 100-789 AF-12 ALFA-INNOCENTI-LANCIA-MASERATI		1 0501-1000 IMS-5 CROMODORA-FIST-IMSA	
				2 0501-1000 AF-19 BLOSTER CROMODORA-FIST-IMSA	
				3 0501-1000 IMS-3.P	
				4 0501-1000 AF-21.P	
				1 0501-1000 IMS-5.P	
				2 0501-1000 AF-19.P BLOSTER CROMODORA-FIST-IMSA	

Copyright by  
Alejandro Altuna S.A.  
2005

**JMA**

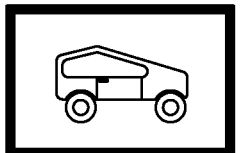

**183**

**PARA-FOR:**

**SIMPLEX (F)**

**PARA:** SIMPLEX  
**FOR:**

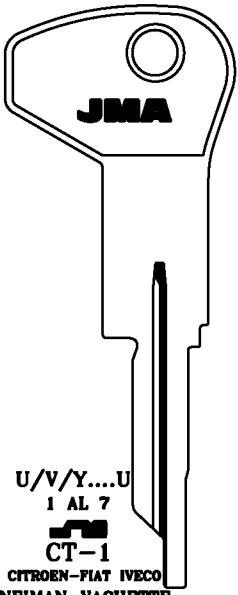
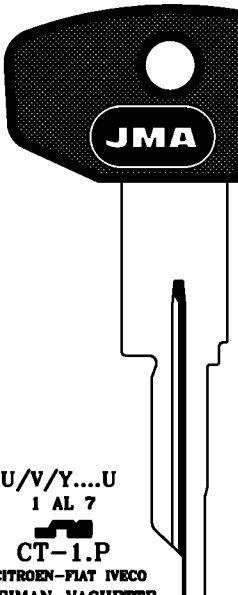
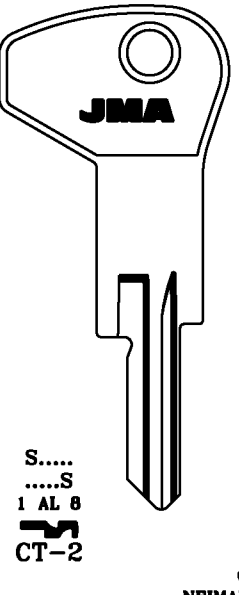
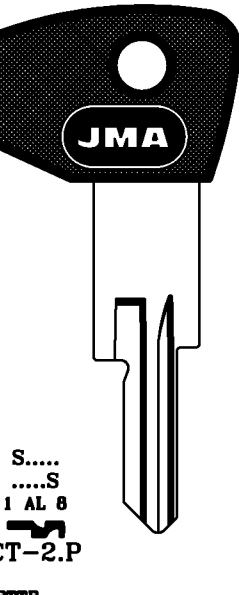
 <p>U/V/Y...U 1 AL 7 CT-1 CITROEN-FIAT IVECO NEIMAN-VACHETTE</p>	 <p>U/V/Y...U 1 AL 7 CT-1.P CITROEN-FIAT IVECO NEIMAN-VACHETTE</p>	 <p>S..... .....S 1 AL 8 CT-2</p>	 <p>S..... .....S 1 AL 8 CT-2.P CITROEN NEIMAN-VACHETTE</p>
---	---	---	--

**PARA:** SIMPLEX  
**FOR:**

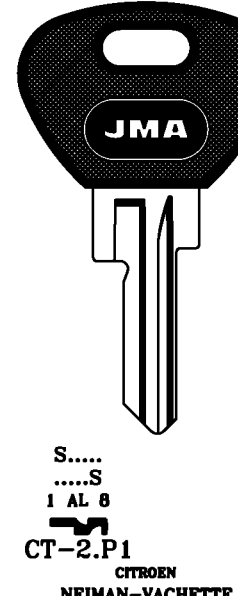
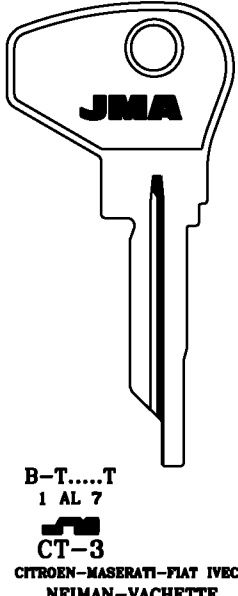
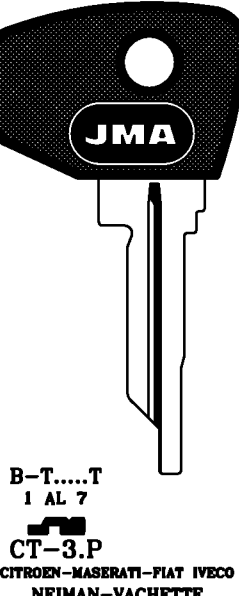
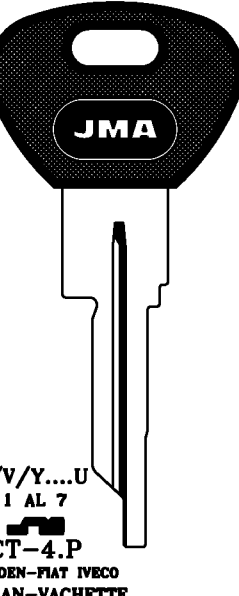
 <p>S..... .....S 1 AL 8 CT-2.P1 CITROEN NEIMAN-VACHETTE</p>	 <p>B-T.....T 1 AL 7 CT-3 CITROEN-MASERATI-FIAT IVECO NEIMAN-VACHETTE</p>	 <p>B-T.....T 1 AL 7 CT-3.P CITROEN-MASERATI-FIAT IVECO NEIMAN-VACHETTE</p>	 <p>U/V/Y...U 1 AL 7 CT-4.P CITROEN-FIAT IVECO NEIMAN-VACHETTE</p>
--	---	--	--

**PARA:** SIMPLEX  
**FOR:**

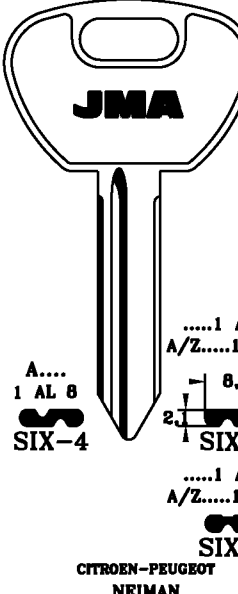
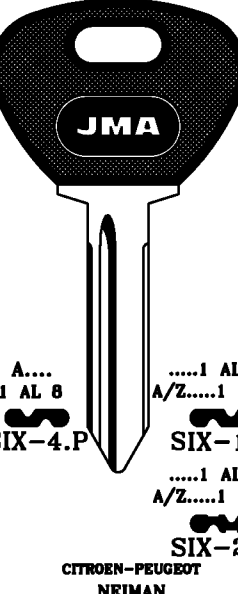
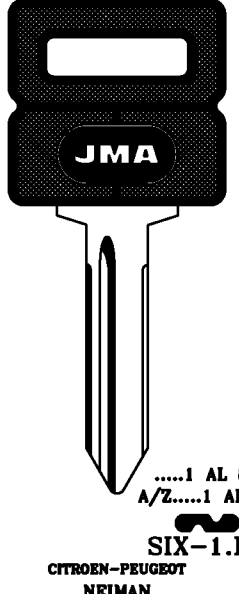
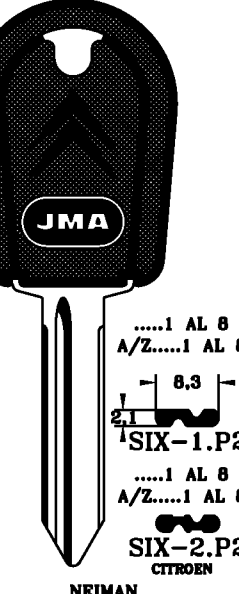
 <p>A.... 1 AL 8 SIX-4</p> <p>.....1 AL 8 A/Z.....1 AL 8 8,3 2,1 SIX-1</p> <p>.....1 AL 8 A/Z.....1 AL 8 SIX-2</p> <p>CITROEN-PEUGEOT NEIMAN</p>	 <p>A.... 1 AL 8 SIX-4.P</p> <p>.....1 AL 8 A/Z.....1 AL 8 SIX-1.P</p> <p>.....1 AL 8 A/Z.....1 AL 8 SIX-2.P</p> <p>CITROEN-PEUGEOT NEIMAN</p>	 <p>.....1 AL 8 A/Z.....1 AL 8 SIX-1.P1</p> <p>CITROEN-PEUGEOT NEIMAN</p>	 <p>.....1 AL 8 A/Z.....1 AL 8 8,3 2,1 SIX-1.P2</p> <p>.....1 AL 8 A/Z.....1 AL 8 SIX-2.P2</p> <p>CITROEN NEIMAN</p>
---	---	---	---

Copyright by Alejandro Altuna S.A. 2005

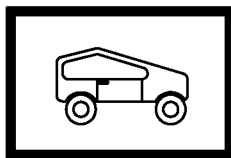

ATENCION:Concernente a las marcas y denominaciones comerciales ver nota en indice.ATTENTION:Concerning the marks and commercial denominations see note in index. ATTENTION:Concernant les marques et denominations commerciales voir la note dans l'index.ACHTUNG:Beziehen auf die marke und handelsname sehen sie die notiz im index.

PARA:  
FOR:

**SIMPLEX**

**PARA-FOR:**

**SIMPLEX (F)**

**SIPEA (I)**

**SISPA (I)**

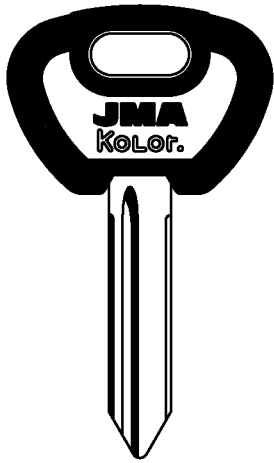

.....1 AL 8  
A/Z.....1 AL 8  
  
**SIX-1K.P**  
CITROEN-PEUGEOT  
NEIMAN

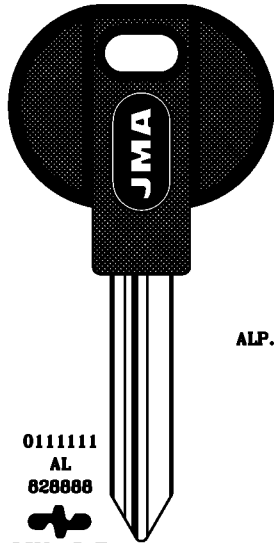

0111111  
AL  
828888  
  
**SIX-3.P**  
CITROEN

ALP.

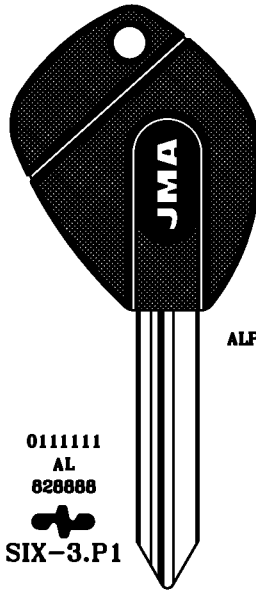

0111111  
AL  
828888  
  
**SIX-3.P1**  
CITROEN-FIAT-LANCIA-PEUGEOT

ALP.

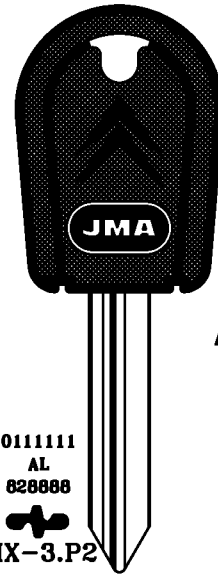

0111111  
AL  
828888  
  
**SIX-3.P2**  
CITROEN

ALP.

PARA:  
FOR: **SIMPLEX**

**SIPEA**

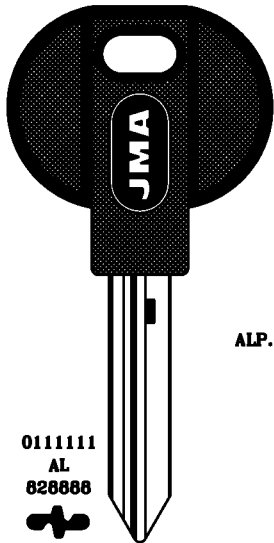

0111111  
AL  
828888  
  
**SIX-5.P**  
CITROEN

ALP.

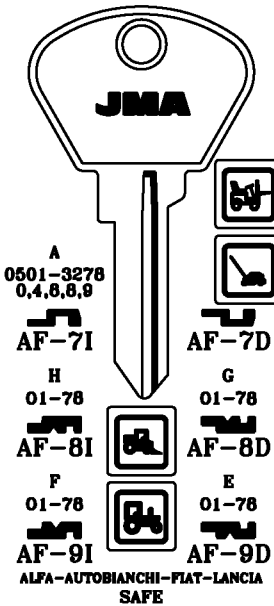

A  
0501-3278  
0,4,8,8,9  
  
**AF-7I**

G  
01-78  
**AF-7D**

H  
01-78  
  
**AF-8I**

E  
01-78  
  
**AF-8D**

F  
01-78  
  
**AF-9I**

**AF-9D**

ALFA-AUTOBIANCHI-FIAT-LANCIA  
SAFE

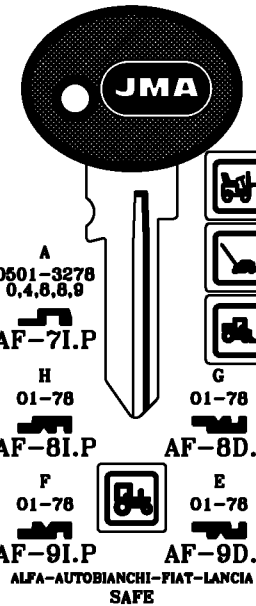

A  
0501-3278  
0,4,8,8,9  
  
**AF-7I.P**

H  
01-78  
  
**AF-8I.P**

F  
01-78  
  
**AF-9I.P**

G  
01-78  
  
**AF-8D.P**

E  
01-78  
  
**AF-9D.P**

ALFA-AUTOBIANCHI-FIAT-LANCIA  
SAFE

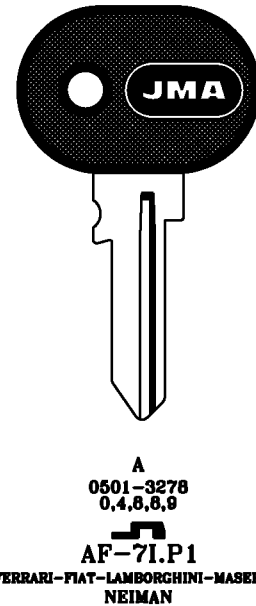

A  
0501-3278  
0,4,8,8,9  
  
**AF-7I.P1**  
FERRARI-FIAT-LAMBORGHINI-MASERATI  
NEIMAN

PARA:  
FOR:

**SIPEA**

**SISPA**

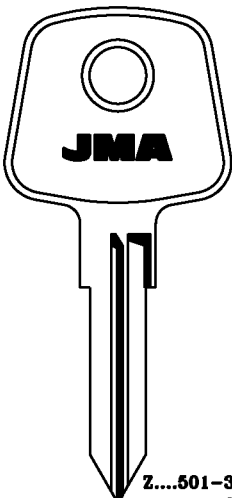

Z....501-3278  
P....501-3278  
  
**SIP-1**  
OM IVECO-YUGO ZASTAVA-FIAT IVECO

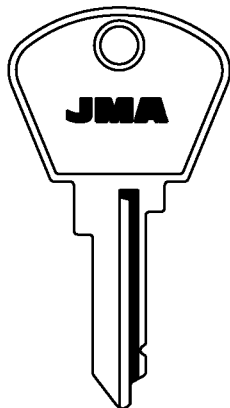

....4-8-8-9  
  
**SIP-2**  
FIAT-PREMIER  
MAGNETI MARELLI-NEIMAN

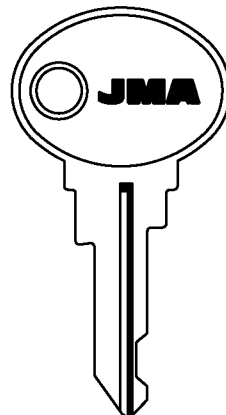

B....501-3278  
B....0-4-8-8-9  
  
**SIP-3**  
A.ROMEO-AUTOBIANCHI-FIAT-LANCIA  
ARTEB-CLAUSOR-NEIMAN

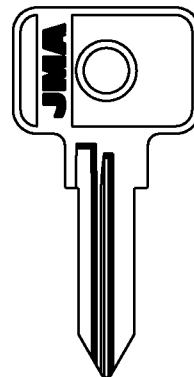

....1100-1307  
  
**SI-1D**  
AUTOBLOCK

Copyright by  
Alejandro Altuna S.A.  
2005



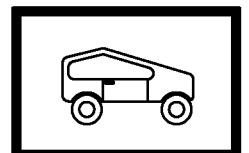







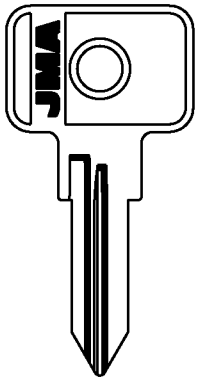
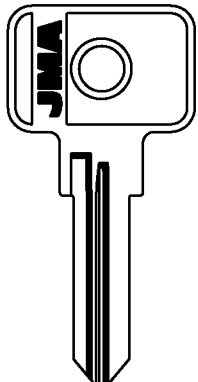
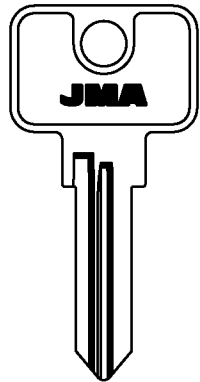
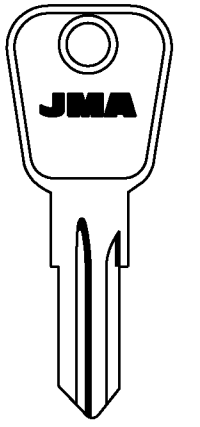
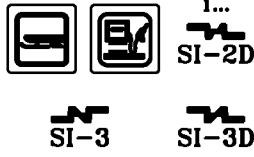
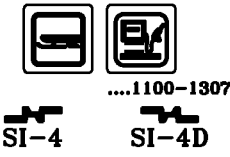

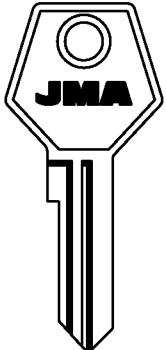
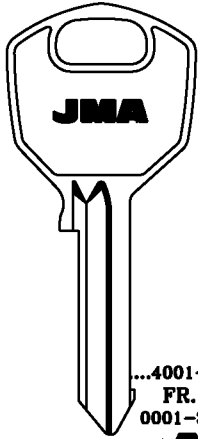
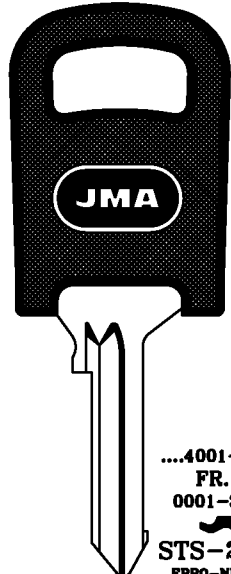
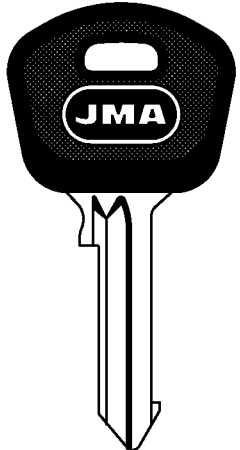

**JMA**

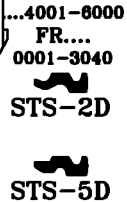

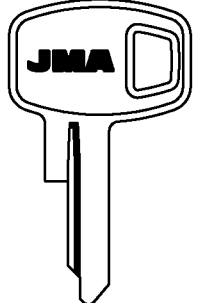
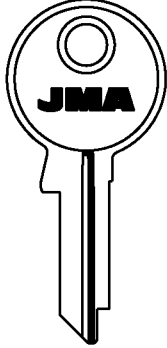
**185**

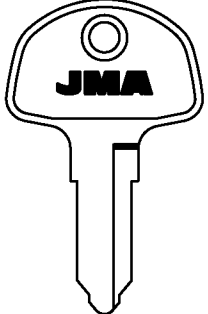
**PARA-FOR:**

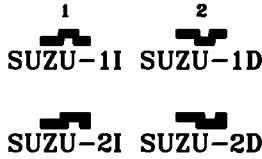
**SISPA (I)**  
**STREBOR (GB)**  
**STS (E)**  
**SUZUKI (J)**

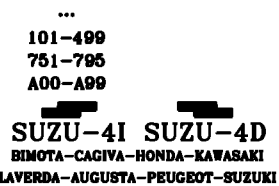
PARA: FOR:	SISPA	STREBOR	
	          <b>AUTOBLOCK</b> <b>AUTOBLOCK</b> <b>AUTOBLOCK</b> <b>UNION</b>		
<b>PARA: FOR:</b>	<b>STREBOR</b>	<b>STS</b>	
	        <b>S..1-70</b> <b>STR-4</b> <b>...4001-8000</b> <b>FR....</b> <b>0001-3040</b> <b>STS-2D</b> <b>STS-5D</b> <b>EBRO-NISSAN</b> <b>BLOCK-DOM</b> <b>...4001-8000</b> <b>FR....</b> <b>0001-3040</b> <b>STS-2D.P</b> <b>EBRO-NISSAN</b> <b>BLOCK-DOM</b> <b>STS-5D.P</b> <b>EBRO-NISSAN</b> <b>DOM</b>		
<b>PARA: FOR:</b>	<b>STS</b>	<b>SUZUKI</b>	
	        <b>STS-11</b> <b>PIAGGIO</b> <b>SUZU-11 SUZU-1D</b> <b>SUZU-2I SUZU-2D</b> <b>SUZU-3I</b> <b>SUZUKI</b> <b>...4</b> <b>101-499</b> <b>751-795</b> <b>A00-A99</b> <b>SUZU-4I SUZU-4D</b> <b>BIMOTA-CAGIVA-HONDA-KAWASAKI</b> <b>LAVERDA-AUGUSTA-PEUGEOT-SUZUKI</b>		

Copyright by  
 Alejandro Altuna S.A.  
 2005

**JMA**

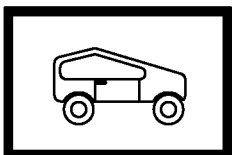

**186**

PARA:  
FOR:

### SUZUKI

PARA-FOR:

SUZUKI (J)

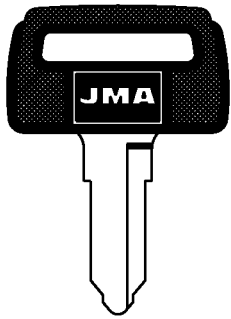

...  
101-499  
751-795  
A00-A99

SUZU-4I.P SUZU-4D.P  
BIMOTA-CAGIVA-HONDA-KAWASAKI  
LAVERDA-AUGUSTA-PEUGEOT-SUZUKI

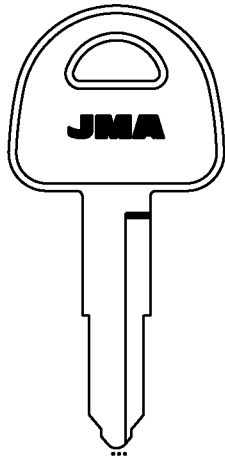

...  
101-499  
751-795

SUZU-5  
BIMOTA-SUZUKI

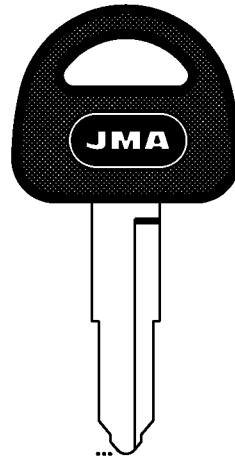

...  
101-499  
751-795

SUZU-5.P  
BIMOTA-SUZUKI

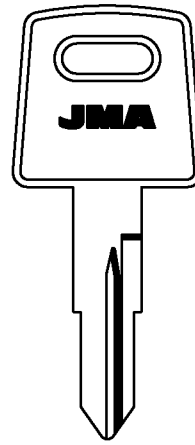

A  
001-133

SUZU-6

PARA:  
FOR:

### SUZUKI

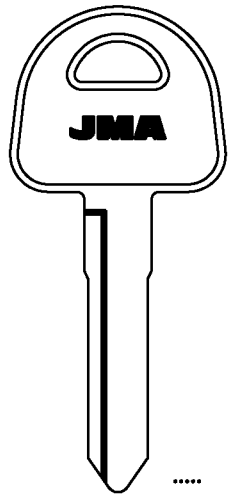

.....  
16501-17704

SUZU-7  
GM-MARUTI-SUZUKI

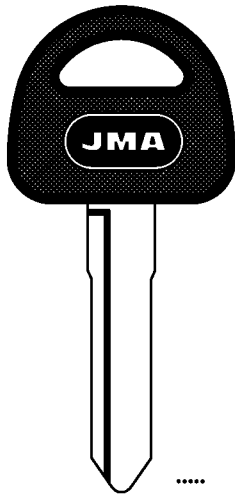

.....  
16501-17704

SUZU-7.P  
GM-MARUTI-SUZUKI

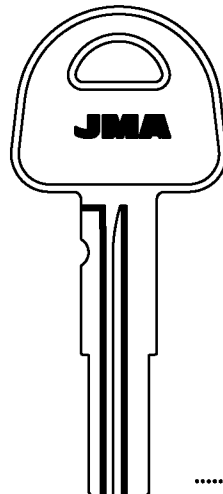

.....  
16100-19229

SUZU-8  
SUZUKI

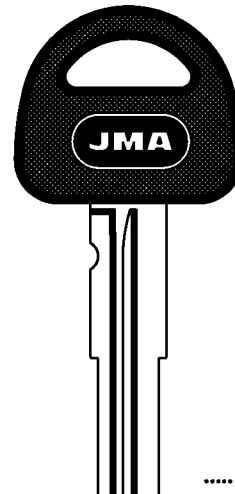

.....  
16100-19229

SUZU-8.P  
SUZUKI

PARA:  
FOR:

### SUZUKI

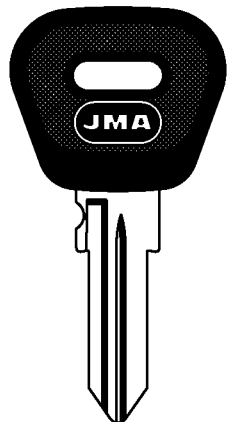

.....1 AL 5

SUZU-9.P  
SUZUKI  
CLAUSOR

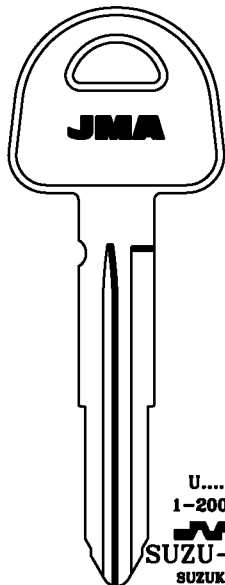

U....  
1-2000

SUZU-10  
SUZUKI

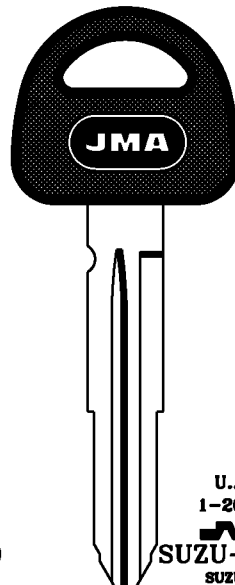

U....  
1-2000

SUZU-10.P  
SUZUKI

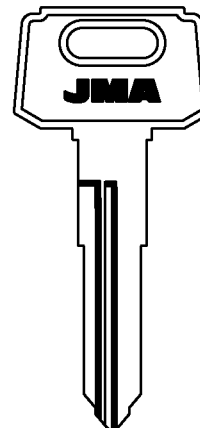

.....  
6001-7000

SUZU-11D  
SUZUKI

Copyright by  
Alejandro Altuna S.A.  
2005

# JMA

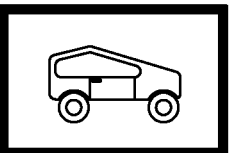

# 187

**PARA-FOR:**

**SUZUKI (J)**









**TAP-AGIS (YU)**

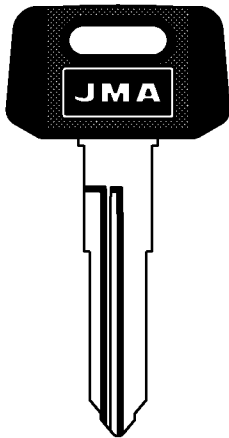

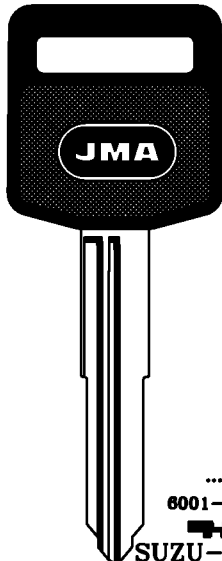

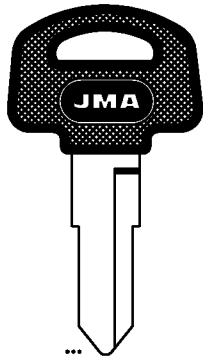

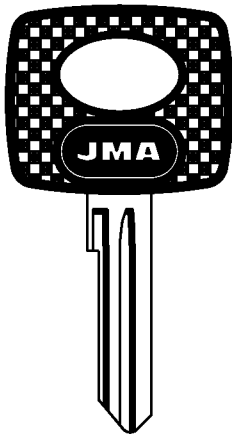

**TECUMSEH (A)**

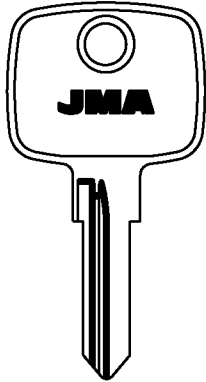

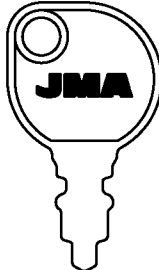

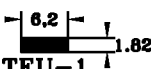
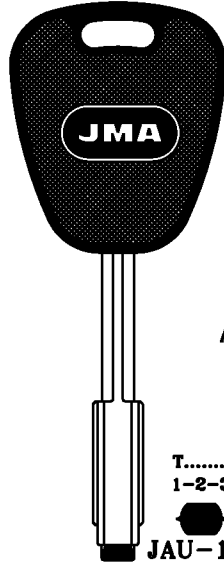

**TIBBE (D)**

**TITAN (YU)**

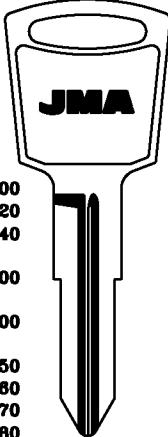
**TOYOTA (J)**

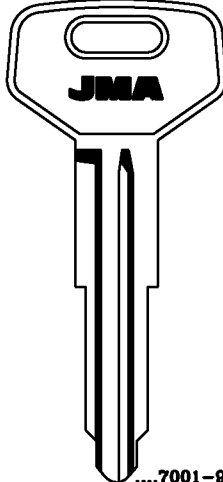
<b>PARA:</b> <b>FOR:</b>	<b>SUZUKI</b>		<b>TAP-AGIS</b>	
	 .... 6001-7000  <b>SUZU-11D.P</b> SUZUKI	 .... 6001-7000  <b>SUZU-12D.P</b> SUZUKI	 ... 101-499 751-795 A00-A99  <b>SUZU-13.P</b>  <b>SUZU-13D.P</b> BIMOTA-CAGIVA-HONDA-KAWASAKI LAVERDA-AUGUSTA-PEUGEOT-SUZUKI	   <b>TAP-1P</b>

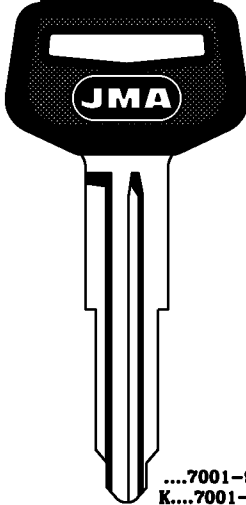
<b>PARA:</b> <b>FOR:</b>	<b>TAP-AGIS</b>	<b>TECUMSEH</b>	<b>TIBBE</b>	<b>TITAN</b>
	   <b>TAP-2</b>	    <b>TEU-1</b> INDAK	 ALP. T..... 1-2-3  <b>JAU-1.P</b>	   <b>TIT-7D</b>

<b>PARA:</b> <b>FOR:</b>	<b>TOYOTA</b>		
	 A.... 0001-0400 2221-2620 4441-4840 B.... 5001-6000 C.... 6001-7000 M.... 5551-5950 6661-7060 7771-8170 8814-9280 N.... 1921-2220  <b>TOYO-2</b> GM-TOYOTA TOKAJ-RIKA	 ....7001-9000 K....7001-9000  <b>TOYO-3</b> DAIHATSU-TOYOTA TOKAJ-RIKA	 ....7001-9000 K....7001-9000  <b>TOYO-3.P</b> DAIHATSU-TOYOTA TOKAJ-RIKA

Copyright by  
Alejandro Altuna S.A.  
2005

**JMA**

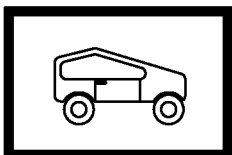

**188**

PARA:  
FOR:

# TOYOTA

PARA-FOR:

TOYOTA (J)

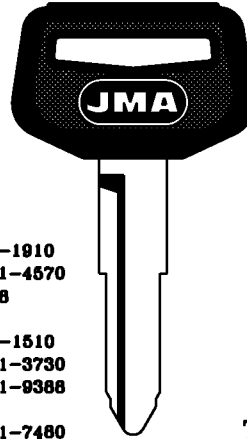
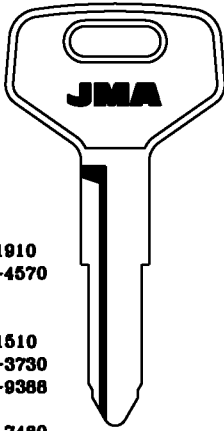

K....  
001-400/1511-1910  
2221-2620/3731-4570  
5001-6368

R....  
401-800/1112-1510  
2821-3020/3331-3730  
5001-8924/8001-9388

S....  
5951-8350/7081-7480  
8171-8570/9281-9880

D....  
8001-7042

TOYO-K1

F....  
5951-8350  
7061-7460  
8171-8570  
9281-9880

P....  
7001-8500

TOYO-4

C....  
8001-7042

TOYO-14

BEDFORD-DAIHATSU-D.MOTOR-HOLDEN-HYUNDAI-ISUZU-LOTUS-SUZUKI-HINO  
TOKAJ-RIKA

K....  
001-400/1511-1910  
2221-2620/3731-4570  
5001-6368

R....  
401-800/1112-1510  
2821-3020/3331-3730  
5001-8924/8001-9388

S....  
5951-8350/7081-7480  
8171-8570/9281-9880

D....  
8001-7042

TOYO-K1.P

F....  
5951-8350  
7061-7460  
8171-8570  
9281-9880

P....  
7001-8500

TOYO-4.P

C....  
8001-7042

TOYO-14.P

PARA:  
FOR:

# TOYOTA

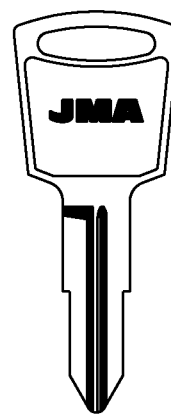
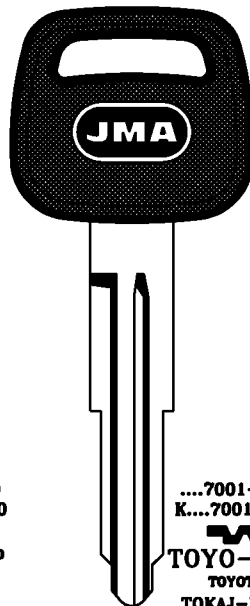
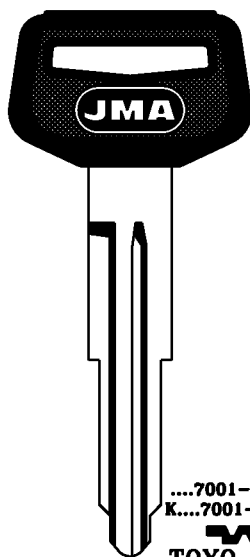
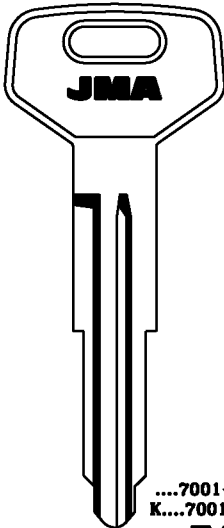

....7001-9000  
K....7001-9000

TOYO-5

TOYOTA  
TOKAJ-RIKA

....7001-9000  
K....7001-9000

TOYO-5.P

TOYOTA  
TOKAJ-RIKA

....7001-9000  
K....7001-9000

TOYO-5.P1

TOYOTA  
TOKAJ-RIKA

TOYO-6

TOKAJ-RIKA

PARA:  
FOR:

# TOYOTA

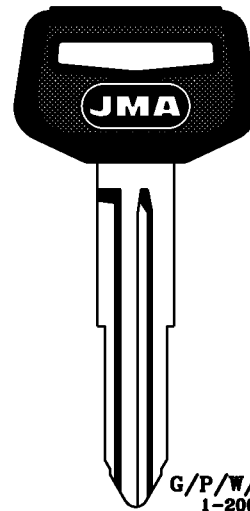
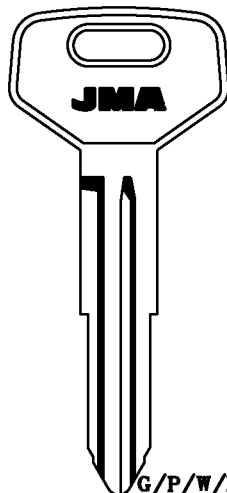
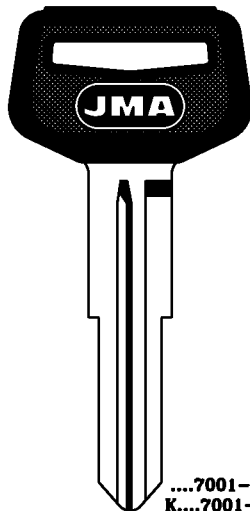
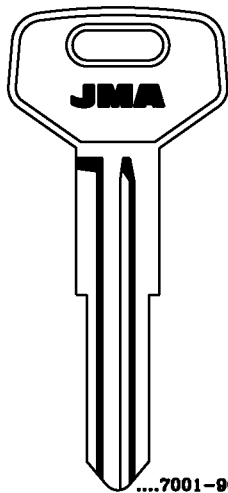

....7001-9000  
K....7001-9000

TOYO-8

DAIHATSU-TOYOTA  
TOKAJ-RIKA

....7001-9000  
K....7001-9000

TOYO-81.P

DAIHATSU-TOYOTA  
TOKAJ-RIKA

G/P/W/X....  
1-2000

TOYO-9

TOYOTA-VOLKSWAGEN  
TOKAJ-RIKA

G/P/W/X....  
1-2000

TOYO-9.P

TOYOTA-VOLKSWAGEN  
TOKAJ-RIKA

Copyright by  
Alejandro Altuna S.A.  
2005

# JMA

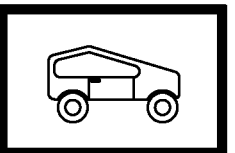

# 189

**PARA-FOR:**

**PARA:  
FOR:**

**TOYOTA**

**TOYOTA (J)**

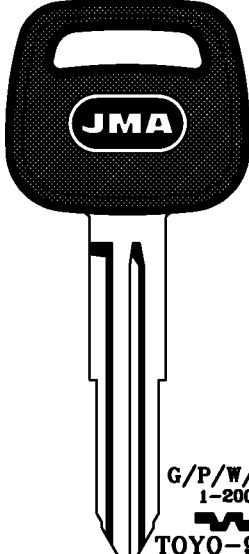
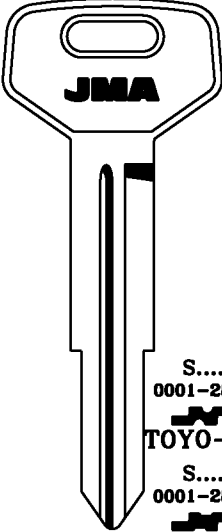
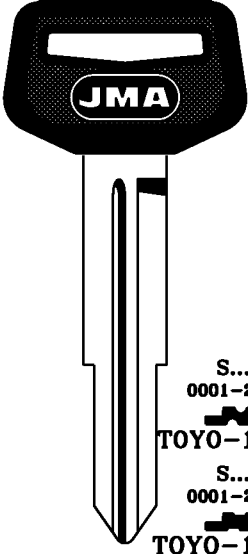
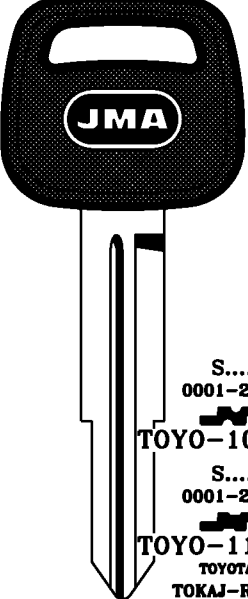
 G/P/W/X.... 1-2000 TOYO-9.P1 TOYOTA-VOLKSWAGEN TOKAJ-RIKA	 S.... 0001-2878 TOYO-10 S.... 0001-2878 TOYO-11 TOYOTA TOKAJ-RIKA	 S.... 0001-2878 TOYO-10.P S.... 0001-2878 TOYO-11.P TOYOTA TOKAJ-RIKA	 S.... 0001-2878 TOYO-10.P1 S.... 0001-2878 TOYO-11.P1 TOYOTA TOKAJ-RIKA
--	---	--	---

**PARA:  
FOR:**

**TOYOTA**

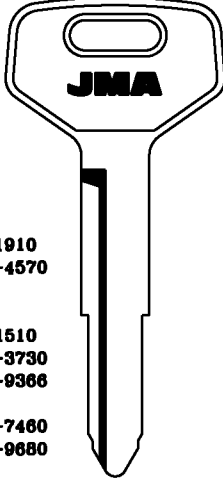
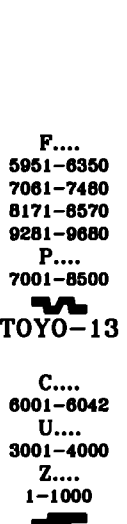
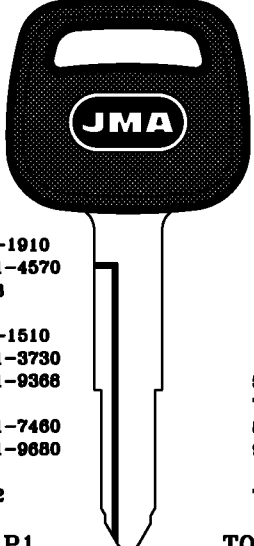
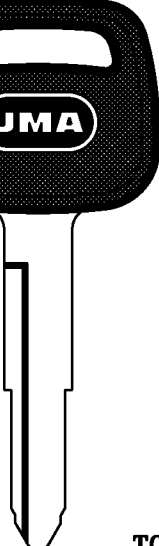
 K.... 001-400/1511-1910 2221-2620/3731-4570 5001-6368 R.... 401-800/1112-1510 2621-3020/3331-3730 5001-6924/8001-9368 S.... 5951-6350/7061-7460 8171-8570/9281-9680 D.... 6001-7042 TOYO-12 TOYOTA TOKAJ-RIKA	 F.... 5951-6350 7061-7460 8171-8570 9281-9680 P.... 7001-8500 TOYO-13 C.... 6001-6042 U.... 3001-4000 Z.... 1-1000 TOYO-12D TOYOTA TOKAJ-RIKA	 K.... 001-400/1511-1910 2221-2620/3731-4570 5001-6368 R.... 401-800/1112-1510 2621-3020/3331-3730 5001-6924/8001-9368 S.... 5951-6350/7061-7460 8171-8570/9281-9680 D.... 6001-7042 TOYO-12.P1 TOYOTA TOKAJ-RIKA	 F.... 5951-6350 7061-7460 8171-8570 9281-9680 P.... 7001-8500 TOYO-13.P1 TOYOTA TOKAJ-RIKA
--	---	---	---

**PARA:  
FOR:**

**TOYOTA**

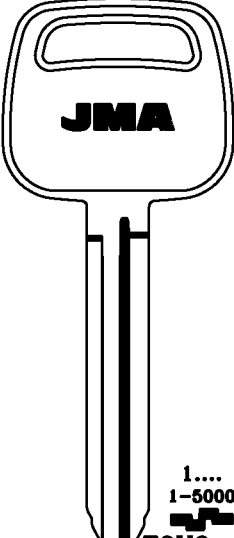
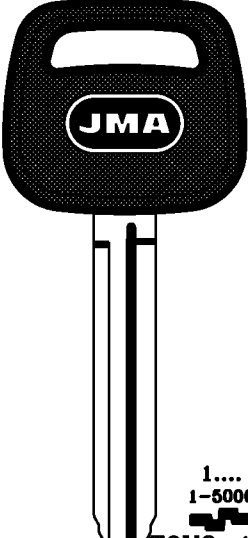
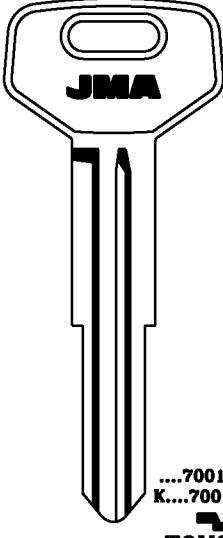
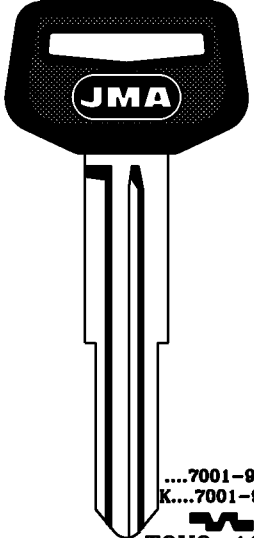
 1.... 1-5000 TOYO-15 GM-TOYOTA TOKAJ-RIKA	 1.... 1-5000 TOYO-15.P GM-TOYOTA TOKAJ-RIKA	 ....7001-9000 K....7001-9000 TOYO-16 TOYOTA TOKAJ-RIKA	 ....7001-9000 K....7001-9000 TOYO-16.P TOYOTA TOKAJ-RIKA
--	--	--	---

Copyright by  
Alejandro Altuna S.A.  
2005

**JMA**

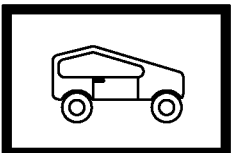

**190**

ATENCION:Concernente a las marcas y denominaciones comerciales ver nota en indice.ATTENTION:Concerning the marks and commercial denominations see note in index.  
ATTENTION:Concernant les marques et denominations commerciales voir la note dans l'index.ACHTUNG:Beziehen auf die marke und handelsname sehen sie die notiz im index.

PARA:  
FOR:

TOYOTA

PARA-FOR:

TOYOTA (J)

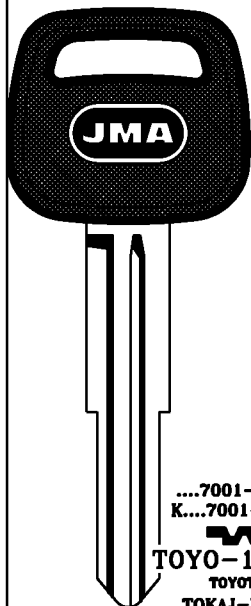

....7001-9000  
K....7001-9000  
  
TOYO-16.P1  
TOYOTA  
TOKAJ-RIKA

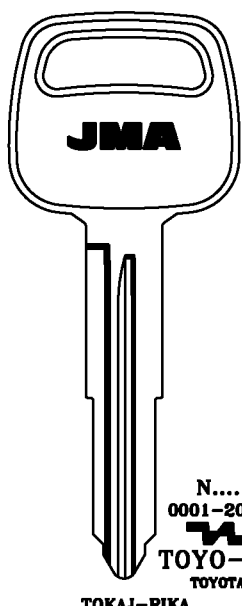

N....  
0001-2000  
  
TOYO-17  
TOYOTA  
TOKAJ-RIKA

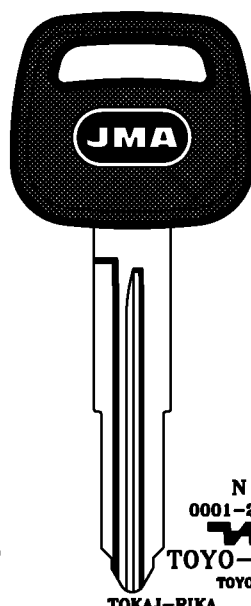

N  
0001-2000  
  
TOYO-17.P  
TOYOTA  
TOKAJ-RIKA

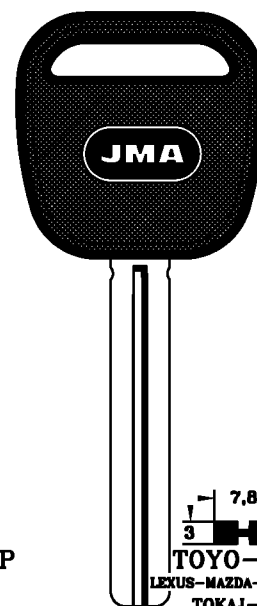

LAT.  
  
TOYO-18.P  
LEXUS-MAZDA-TOYOTA  
TOKAJ-RIKA

PARA:  
FOR:

TOYOTA

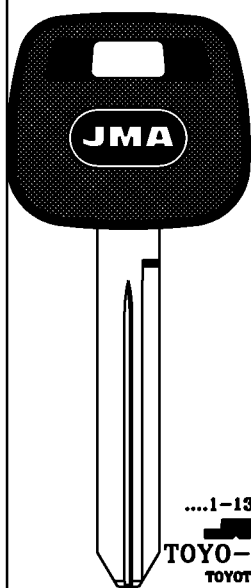

....1-13284  
  
TOYO-19.P  
TOYOTA  
VALEO

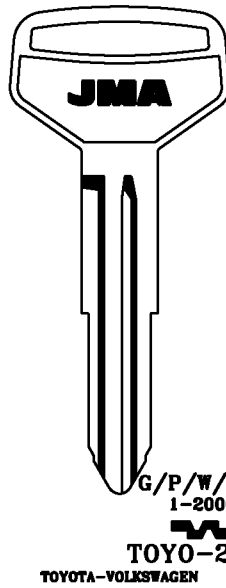

G/P/W/X....  
1-2000  
  
TOYO-20D  
TOYOTA-VOLKSWAGEN  
TOKAJ-RIKA

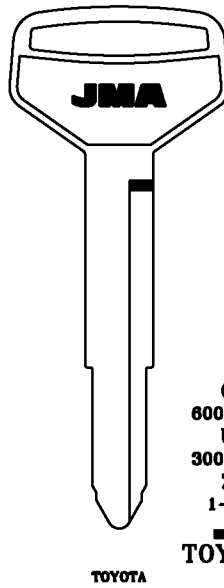

C....  
6001-8042  
U....  
3001-4000  
Z....  
1-1000  
  
TOYO-22  
TOYOTA  
TOKAJ-RIKA

K....  
001-400/1511-1910  
2221-2620/3731-4570  
5001-6368  
R....  
401-600/1112-1510  
2621-3020/3331-3730  
5001-6924/6001-9368  
S....  
5951-8350/7061-7460  
8171-8570/9281-9680  
D....  
6001-7042  
  
TOYO-22D

PARA:  
FOR:

TOYOTA

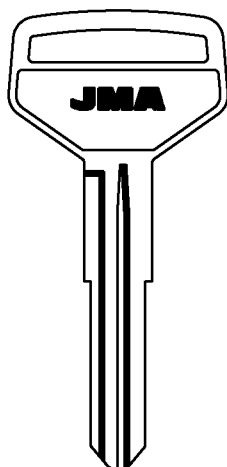

1001-2500  
3001-4500  
  
TOYO-23  
TOKAJ-RIKA

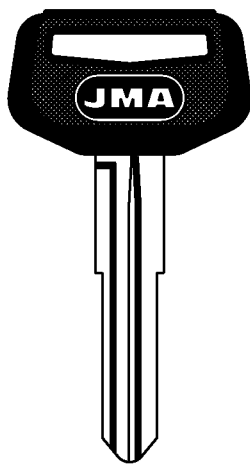

1001-2500  
3001-4500  
  
TOYO-23.P  
TOKAJ-RIKA

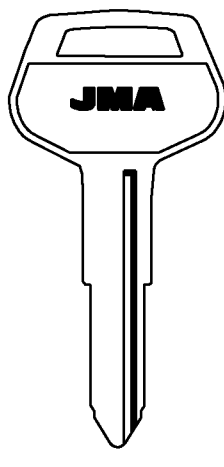

TOYO-24

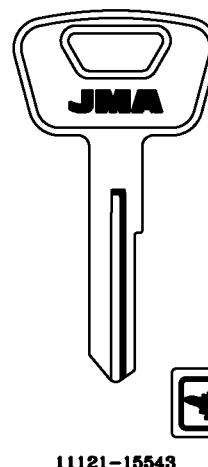

11121-15543  
51112-55424  
5....  
  
TOYO-25

Copyright by  
Alejandro Altuna S.A.  
2005

JMA

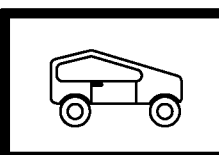

191

**PARA-FOR:**

PARA:  
FOR:

**TOYOTA**

**TOYOTA (J)**  
**TRELOCK (D)**  
**UNION (GB)**

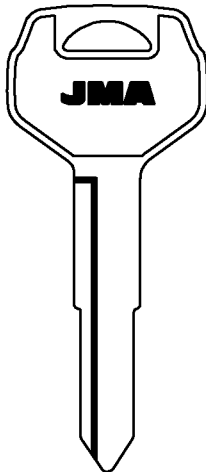

K...1-4130  
R...401-3790  
**TOYO-26**

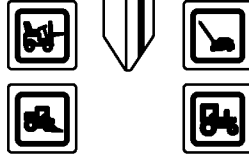
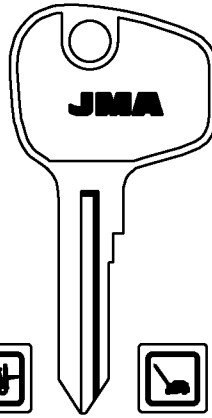

**TOYO-27**  
HINO

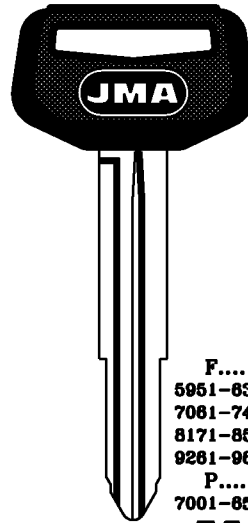

F...  
5951-6350  
7081-7480  
8171-8570  
9261-9880  
P...  
7001-8500  
**TOYO-28.P**  
TOKAJ-RIKA

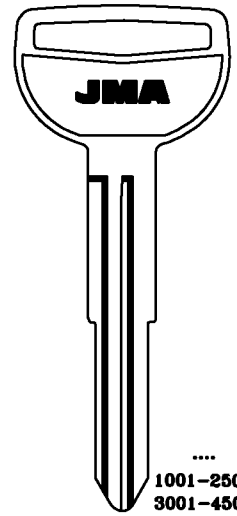

....  
1001-2500  
3001-4500  
**TOYO-29**

PARA:  
FOR: **TRELOCK**

**UNION**

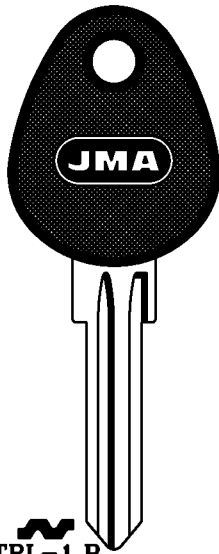

**TRL-1.P**

ASTON MARTIN  
JAGUAR  
LAND ROVER  
MG  
ROVER  
VOLVO

FK  
01-99  
876-955  
**IN-5**



FP  
626-750  
**IN-1**

FS  
01-99  
676-955  
**IN-4**

FR  
751-875  
**UN-4**

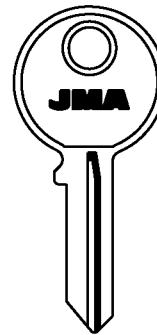

NRA  
FFE...1-100  
FJA...1-100  
FL...251-500  
NRA..51-90  
YFB..1-75  
FMD..1-75  
FG..1-30  
NF..1-30  
EJR..1-75

**UN-FFE**

MC..1-40  
MRA...251-290  
MRN...1-54  
MRN...201-250  
MRN...251-300

**UN-MRN**

FA...  
501-625

**UN-44**



**UN-3**

HX...100  
**UN-2**

RM...  
911-952

**UN-44D**

FP...  
626-750  
**UN-FP**

FR...  
751-875  
**UN-FR**

NGN..1-54  
**UN-NG**

BRITISH LEYLAND-FORD-HILLMAN-JAGUAR-LAND ROVER-MG-MORRIS-ROVER

PARA:  
FOR:

**UNION**

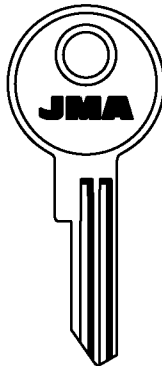

KB662  
**UN-46D**

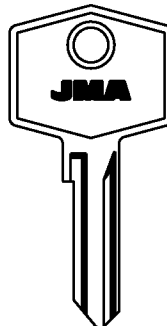

FK...  
01-99  
876-955

**UN-FK**

JAGUAR-VAUXHALL



FS...  
01-99  
876-955

**UN-FS**

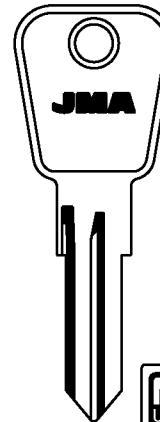

FT-BC...301-360  
BC-FT...101-225  
LF...451-575  
CB...801-875

**UN-FT**

BEDFORD-B.LEYLAND-FORD  
CEM



TF  
TF...1001-1140

**UN-TF**

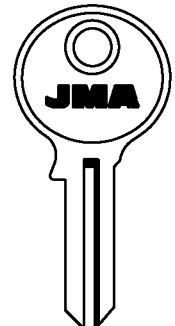

NC...  
1-1000

**UN-NC**

Copyright by  
Alejandro Altuna S.A.  
2005

**JMA**

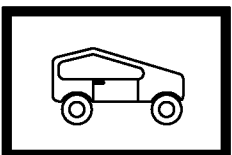

**192**

PARA:  
FOR:

### UNION

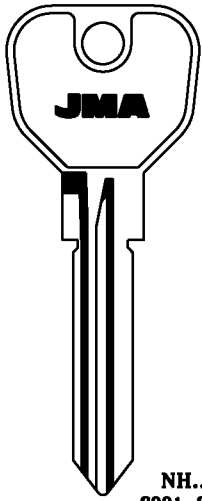

NH....  
2001-3000  
UN-NH  
MG-ROVER-TRIUMPH  
CEM

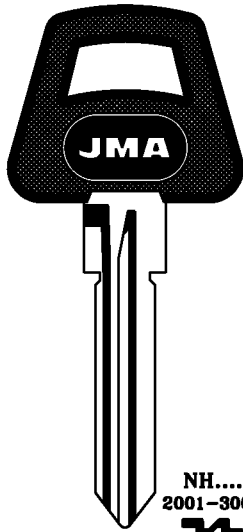

NH....  
2001-3000  
UN-NH.P  
MG-ROVER-TRIUMPH  
CEM

### VACHETTE



....1 AL 9 AL 0  
E....9001-9100  
....R9001-9100  
VA-3I VA-3  
ISEO-KLIT

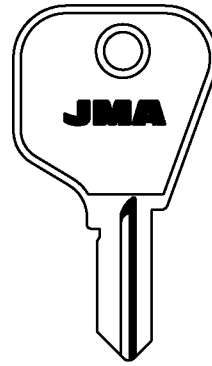

E...  
001-649  
VA-6  
CITROEN-PEUGEOT-TALBOT SIMCA  
SIMPLEX

PARA-FOR:

UNION (GB)

VACHETTE (F)

PARA:  
FOR:

### VACHETTE

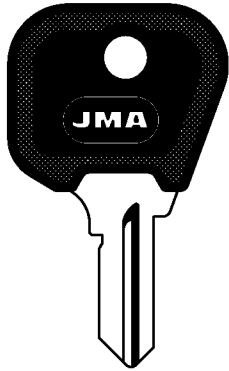

E...  
001-649  
VA-6.P  
CITROEN-PEUGEOT-TALBOT SIMCA  
SIMPLEX

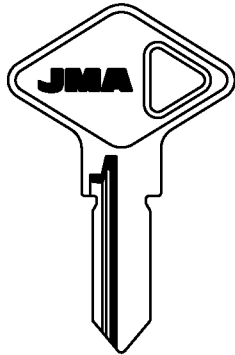

1R...000-999  
2R...1000-1837  
3R...000-665  
VA-7  
RENAULT-TALBOT SIMCA

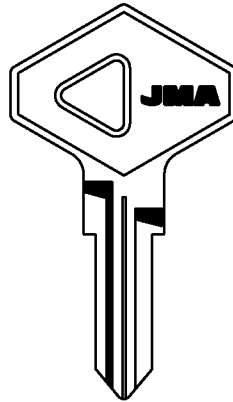

A/Z....  
....A/Z  
....A/Z 1/9  
2700-4816  
VA-10  
A.MOTORS-CHRYSLER-RENAULT

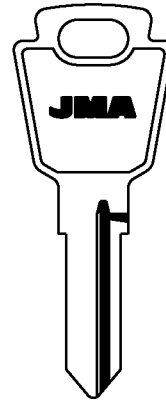

A...000-999  
B...000-999  
F...000-116  
VA-16  
TALBOT SIMCA

PARA:  
FOR:

### VACHETTE

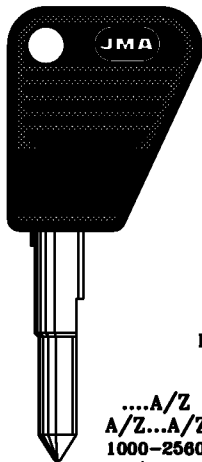

LAT.  
....A/Z  
A/Z...A/Z  
1000-2560  
.E....A/Z 0 AL 4  
VA-17.P  
RENAULT  
NEIMAN

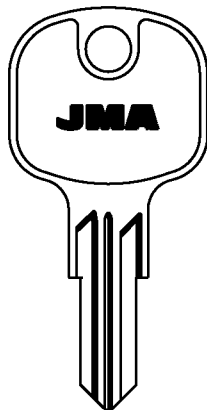

...E  
001-649  
VA-18  
PEUGEOT

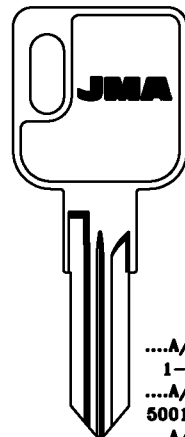

....A/Z 0/9  
1-4092  
....A/Z 0/9  
5001-9092  
....A/Z 0/9  
1-4092  
...A/Z 0/9  
5001-9092  
VA-34  
RENAULT

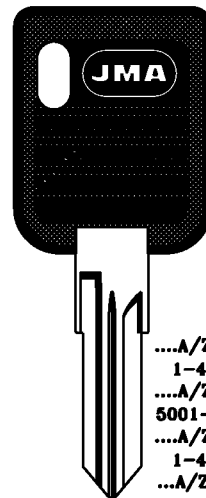

....A/Z 0/9  
1-4092  
....A/Z 0/9  
5001-9092  
....A/Z 0/9  
1-4092  
...A/Z 0/9  
5001-9092  
VA-34.P  
RENAULT

Copyright by  
Alejandro Altuna S.A.  
2005

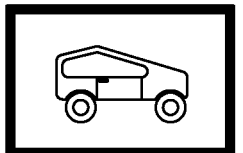



**PARA-FOR:**

**VACHETTE (F)**

**VOLGA (RUS)**

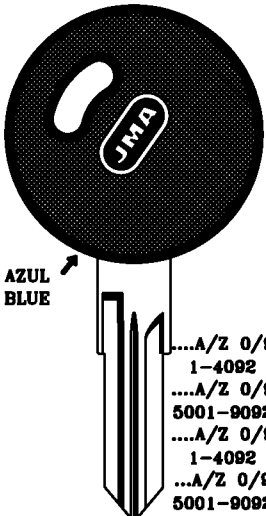
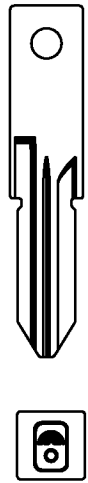
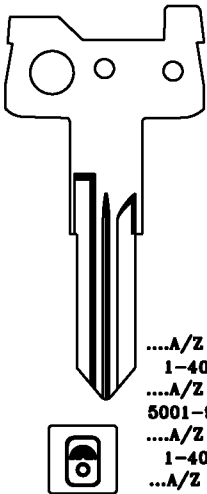
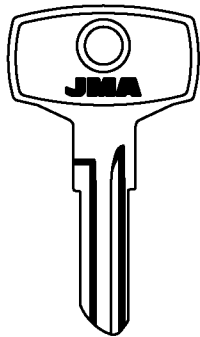
**WASO (D)**

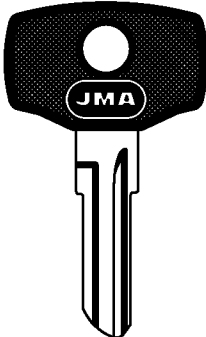
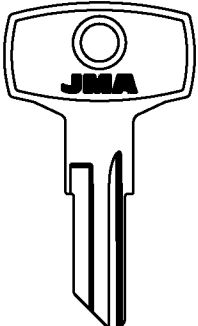
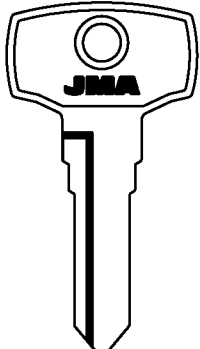
PARA: FOR:	VACHETTE	VOLGA
 <p>AZUL BLUE</p> <p>....A/Z 0/9 1-4092 ....A/Z 0/9 5001-9092 ....A/Z 0/9 1-4092 ....A/Z 0/9 5001-9092</p> <p><b>VA-34.P1</b> RENAULT</p>	 <p>....A/Z 0/9 1-4092 ....A/Z 0/9 5001-9092 ....A/Z 0/9 1-4092 ....A/Z 0/9 5001-9092</p> <p><b>VA-61C1</b></p>	 <p>....A/Z 0/9 1-4092 ....A/Z 0/9 5001-9092 ....A/Z 0/9 1-4092 ....A/Z 0/9 5001-9092</p> <p><b>VA-61C2</b></p>
		 <p><b>VOL-1</b></p>

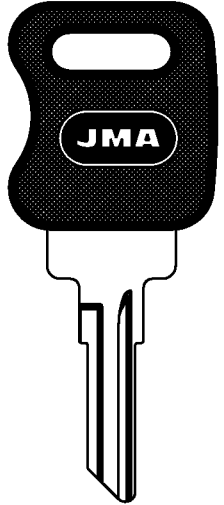
PARA: FOR:	VOLGA			
	 <p><b>VOL-1.P</b></p>	 <p><b>VOL-2</b></p>	 <p><b>VOL-2D</b></p>	 <p><b>VOL-3</b></p>
				 <p><b>VOL-4</b></p>
				 <p><b>VOL-5.P</b></p>
				<b>GAZ-ZAZ</b>

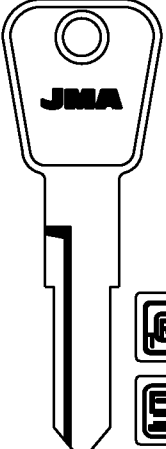
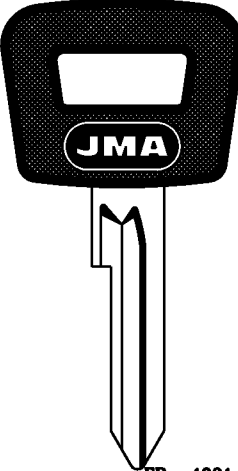
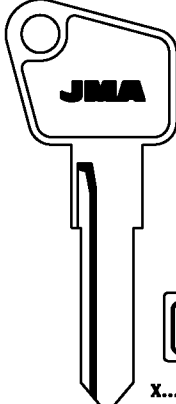
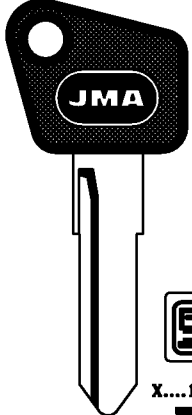
PARA: FOR:	WASO			
	 <p>W... 600-842</p> <p><b>WAS-1</b></p> <p>JAGUAR-ROVER-SAAB-VOLVO</p>	 <p>FR...4001-6000 FZ...1-1232</p> <p><b>WAS-2.P</b></p> <p>JAGUAR-MAZDA-SUBARU-TRIUMPH ARMAN-DOM</p>	 <p>X...1-4088</p> <p><b>WAS-3</b></p> <p>D...1-4088 X...1-4088</p> <p><b>WAS-4</b></p> <p>DAF</p>	 <p>X...1-4088</p> <p><b>WAS-3.P</b></p> <p>D...1-4088 X...1-4088</p> <p><b>WAS-4.P</b></p> <p>DAF</p>

Copyright by  
Alejandro Altuna S.A.  
2005

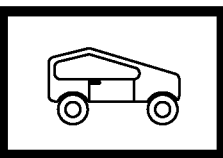



**194**

PARA:  
FOR:

### WASO

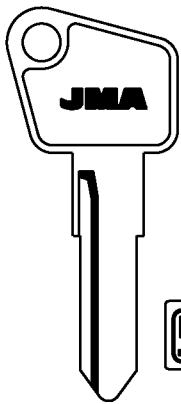
**PARA-FOR:**



W...600-842  
WAS-5  
M...100-174  
WAS-6  
LOTUS-BEDFORD-DAF

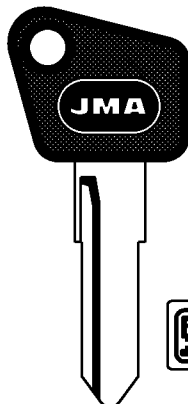

W...600-842  
WAS-5.P  
M...100-174  
WAS-6.P  
LOTUS-BEDFORD-DAF

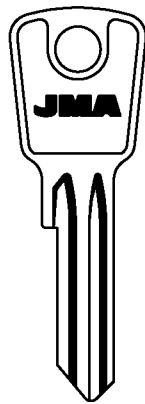

A..... L.....  
0 AL 5 0 AL 5  
WAS-71 WAS-7D

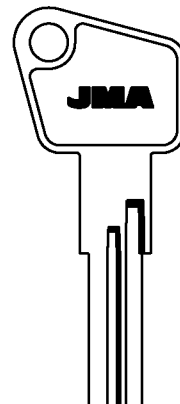

H.... A....  
1-4088 WAS-8D

TOK

UNIPART

WASO (D)  
WEST LOCK (USA)  
WITTE (D)  
YALE (D-GB-USA)

PARA:  
FOR:

### WASO

### WEST LOCK

### WITTE

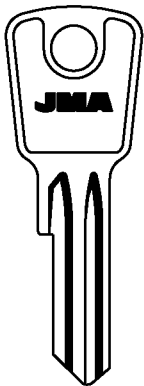

B..... L.....  
0 AL 5  
WAS-9 WAS-9D

TOK WINKHAUS

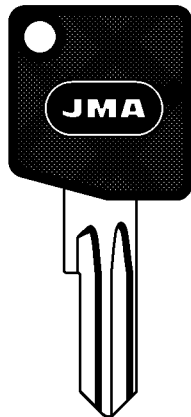

WAS-10.P WAS-10D.P

TRELOCK

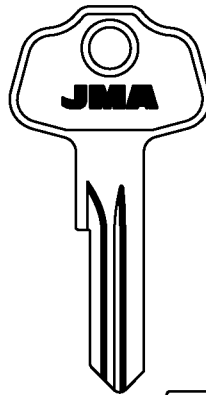

V....  
1 AL 8  
WST-2D

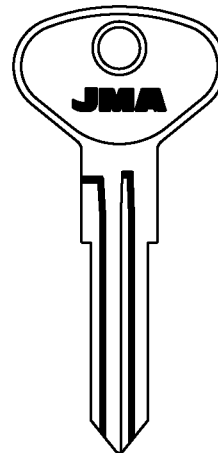

8001-8100  
WIT-1

PARA:  
FOR:

### YALE

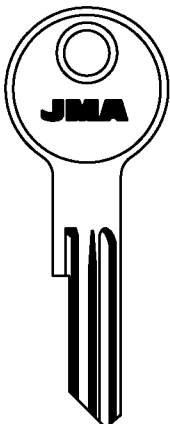

RRL  
YA-18D  
ROLLS ROYCE

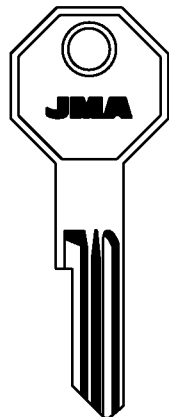

RRM  
YA-19D  
ROLLS ROYCE

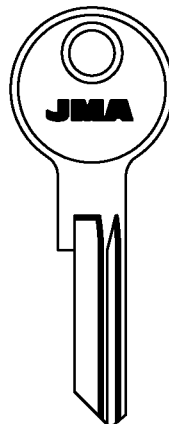

NRRL  
YA-20I YA-20D  
ROLLS ROYCE

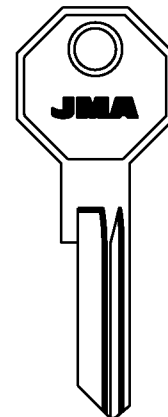

NRRM  
YA-21I YA-21D  
ROLLS ROYCE

Copyright by  
Alejandro Altuna S.A.  
2005

# JMA

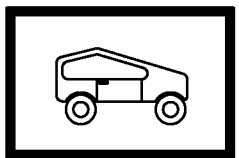



# 195

**PARA-FOR:**

**YALE  
(D-GB-USA)**

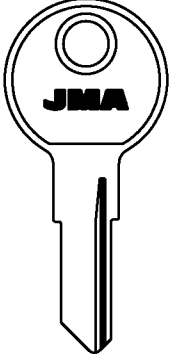
**YAMAHA (J)**

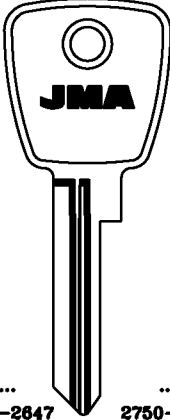
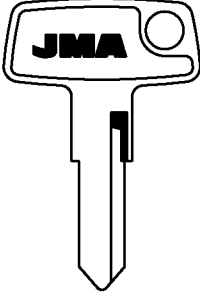
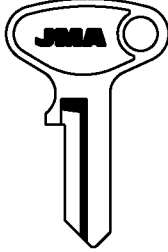
<p><b>PARA: FOR:</b> YALE</p>   <p>YA-37 YA-37D ADEMCO-BENDIX-CHICAGO FORT-ILLINOIS</p>	<p style="text-align: center;"><b>YAMAHA</b></p>  <p>.... 2840-2847</p>  <p>.... 2750-2757</p>  <p>.... 2811-2850    1711-1725</p> <p>YAMA-11    YAMA-1D 2550-2557    2640-2847</p> <p>YAMA-2I    YAMA-2D    YAMA-3I    YAMA-3D    YAMA-4D YAMAHA    YAMAHA    YAMAHA    YAMAHA    YAMAHA</p>
---	---

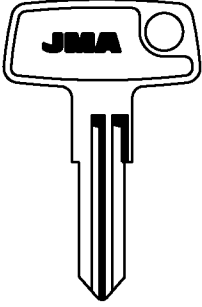
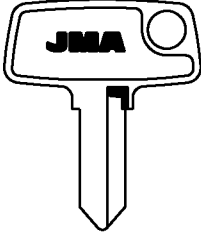
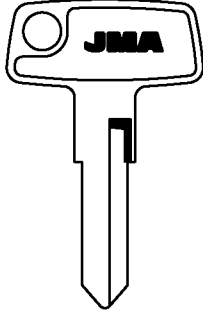
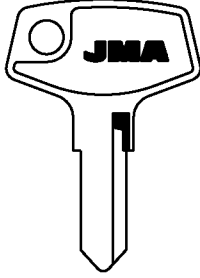
<b>PARA: FOR:</b> YAMAHA			
 <p>.... 2851-2875    1751-1775</p> <p>YAMA-5I    YAMA-5D YAMAHA</p>	 <p>.... 228-234    221-227</p> <p>YAMA-6I    YAMA-6D YAMAHA</p>	 <p>.... 2878-2700    1778-1800</p> <p>YAMA-7I    YAMA-7D YAMAHA</p>	 <p>.... 2109-2115    1209-1215 2811-2825    1711-1725 6201-6212    6101-6112</p> <p>YAMA-8I    YAMA-8D YAMAHA</p>

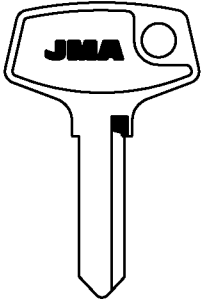
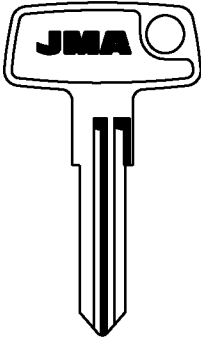
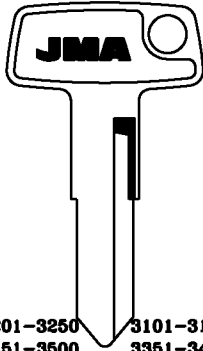
<b>PARA: FOR:</b> YAMAHA			
 <p>.... A201-A208    A101-A108 B201-B208    B101-B108</p> <p>YAMA-9I    YAMA-9D YAMAHA</p>	 <p>.... 2785-2771    1855-1861</p> <p>YAMA-10I    YAMA-10D .... 2758-2784    1848-1854</p> <p>YAMA-11I    YAMA-11D YAMAHA</p>	 <p>.... 3201-3250    3101-3150 3451-3500    3351-3400 4401-4450    4301-4350</p> <p>YAMA-12I    YAMA-12D 3251-3300    3151-3200 3851-3900    3751-3800 4451-4500    4351-4400</p> <p>YAMA-13I    YAMA-13D YAMAHA</p>	<p>3801-3850    3701-3750 4251-4300    4151-4200 4851-4900    4751-4800</p> <p>YAMA-14I    YAMA-14D 3401-3450    3301-3350 4051-4100    3951-4000 4851-4700    4551-4600</p> <p>YAMA-15I    YAMA-15D 3851-3700    3551-3600 4201-4250    4101-4150 4801-4850    4701-4750</p> <p>YAMA-16I    YAMA-16D 3801-3650    3501-3550 4001-4050    3901-3950 4601-4650    4501-4550</p> <p>YAMA-17I    YAMA-17D YAMAHA</p>

Copyright by  
Alejandro Altuna S.A.  
2005

**JMA**

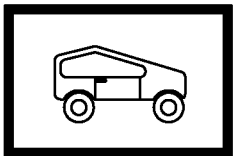

ATENCION:Concerniente a las marcas y denominaciones comerciales ver nota en indice.ATTENTION:Concerning the marks and commercial denominations see note in index.  
ATTENTION:Concernant les marques et denominations commerciales voir la note dans l'index.ACHTUNG:Beziehen auf die marke und handelsname sehen sie die notiz im index.

PARA:  
FOR:

# YAMAHA

PARA-FOR:

YAMAHA (J)

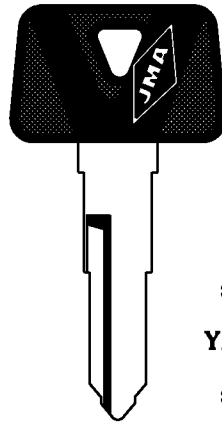
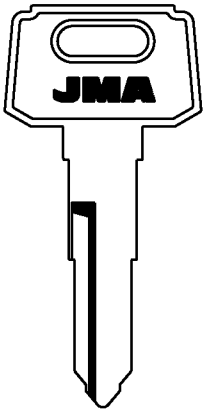

1 AL 4  
32010-79897

1 AL 4  
32010-79897

A.....	B.....
32010-79897	32010-79897
■	■
YAMA-18I	YAMA-18D
C.....	D.....
32010-79897	32010-79897
■	■
YAMA-19I	YAMA-19D
E.....	F.....
32010-79897	32010-79897
■	■
YAMA-20I	YAMA-20D

A.....	B.....
32010-79897	32010-79897
■	■
YAMA-18I.P	YAMA-18D.P
C.....	D.....
32010-79897	32010-79897
■	■
YAMA-19I.P	YAMA-19D.P
E.....	F.....
32010-79897	32010-79897
■	■
YAMA-20I.P	YAMA-20D.P

MALAGUTI-SUZUKI-YAMAHA

MALAGUTI-SUZUKI-YAMAHA

PARA:  
FOR:

# YAMAHA

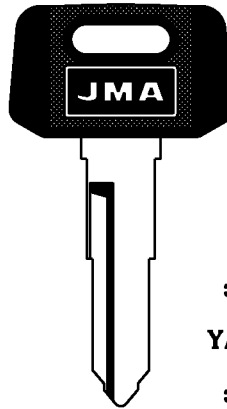
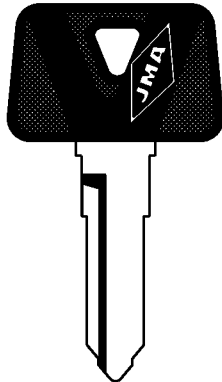
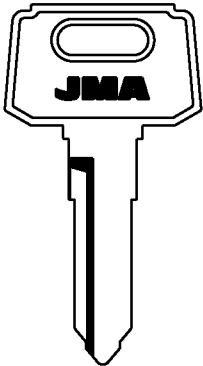

1 AL 4  
32010-79897

A.....	B.....
32010-79897	32010-79897
■	■
YAMA-22I.P	YAMA-22D.P
C.....	D.....
32010-79897	32010-79897
■	■
YAMA-23I.P	YAMA-23D.P
E.....	F.....
32010-79897	32010-79897
■	■
YAMA-24I.P	YAMA-24D.P

....  
7001-8000  
■  
YAMA-21I  
HERCULES-YAMAHA

....  
7001-7999  
■  
YAMA-21I.P  
HERCULES-YAMAHA

YAMAHA

PARA:  
FOR:

# YAMAHA

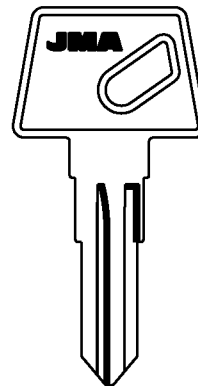
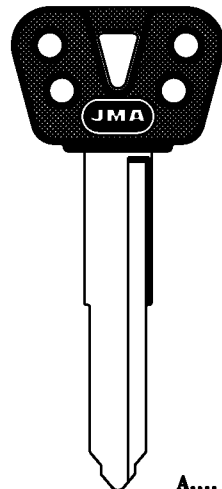
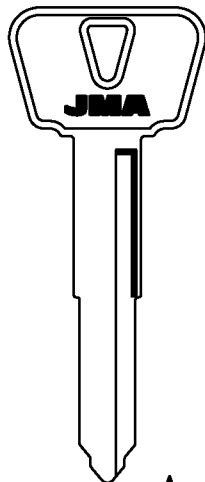
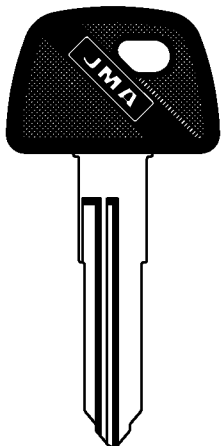

....  
8001-7000  
■

A....  
7000-8000  
■

A....  
7000-8000  
■

....3000  
■

....7000  
■

YAMA-25D.P  
PUCH-VESPA-YAMAHA

YAMA-26  
YAMAHA

YAMA-26D  
YAMAHA

YAMA-26P YAMA-26DP  
YAMAHA

YAMA-27 YAMA-27D  
ITALJET-MALAGUTI-MBK-YAMAHA

Copyright by  
Alejandro Altuna S.A.  
2005

# JMA

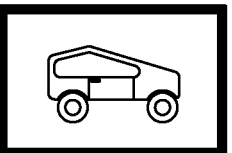







# 197



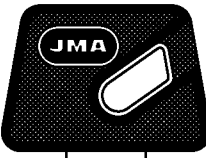
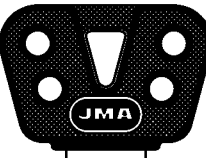

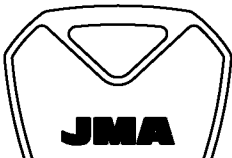

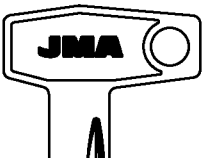



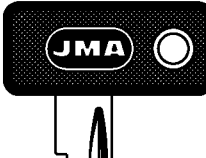

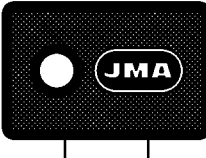
**PARA-FOR:**







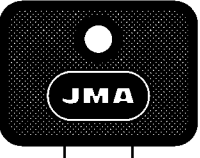

**YAMAHA (J)**

**YUGO (YU)**

**ZADI (I)**

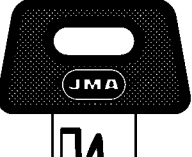
PARA: FOR:	YAMAHA	YUGO	ZADI
	  ....3000  ....7000 <b>YAMA-27P YAMA-27DP</b> ....4000  <b>YAMA-30P</b> ITALJET-MALAGUTI-MBK-YAMAHA	 C..... 32010-79897  <b>YAMA-28.P</b> E..... 32010-79897  <b>YAMA-29.P</b> YAMAHA	  ....1-1625 ....5001-6278 E...1-710  <b>ZA-1</b> BRETER

PARA: FOR:	ZADI			
	  ....1-1625 ....5001-6278 E...1-710  <b>ZA-1.P</b> BRETER	   ....2001-3554 ....8001-9554  <b>ZA-2.P</b> ....8001-9554  <b>ZA-4D.P</b> APRILIA-GILERA-PIAGGIO VESPA	   ...1-390  <b>ZA-3D</b>	  <b>ZA-5.P</b>

PARA: FOR:	ZADI			
	 8001-9554  <b>ZA-6D.P</b> BMW	 8001-9554  <b>ZA-6D.P1</b> APRILIA-BETA	 .... 8001-9554  <b>ZA-7D.P</b> GILERA-PIAGGIO	  <b>ZA-8.P</b>

Copyright by  
Alejandro Altuna S.A.  
2005

**JMA**

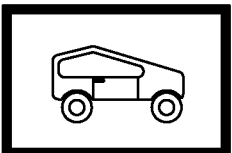

**198**

PARA:  
FOR:

### ZADI

**PARA-FOR:**

ZADI (I)

ZIL (RUS)

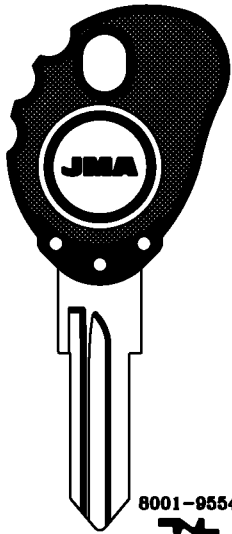

8001-9554  
MALAGUTI-MBK  
ZA-9.P

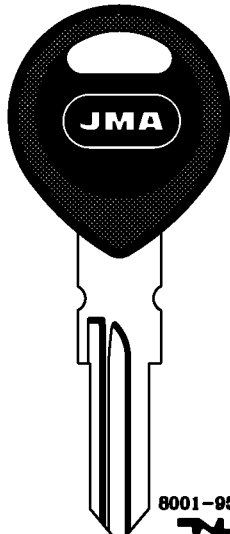

8001-9554  
PIAGGIO-MBK-YAMAHA  
ZA-9.P1

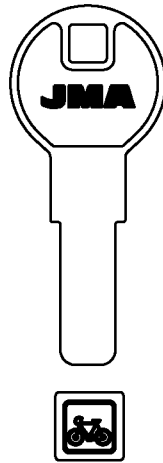

LAT.  
7.3  
ZA-10

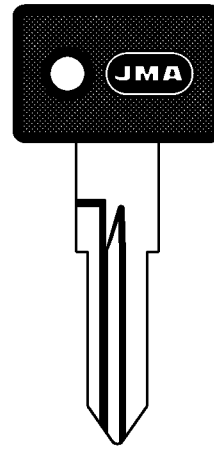

....5001-6475  
ZA-13.P

PARA:  
FOR:

### ZIL

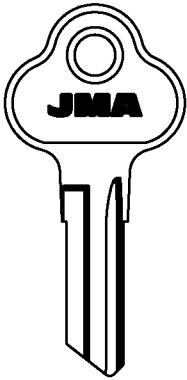

ZI-1

Copyright by  
Alejandro Altuna S.A.  
2005

**JMA**

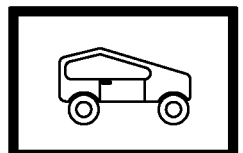

**199**

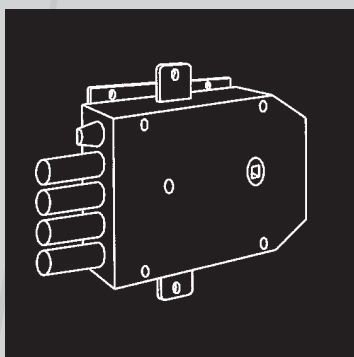

# **JMA**

**LLAVES DE CIERRE**

**IXTEKO GILTZAK**

**SNAP-LOCK KEYS**

**CLÉS DE BOUCHE D'EAU**

**DORNSCHLÜSSEL**

**CHIAVI PER CAMINO**

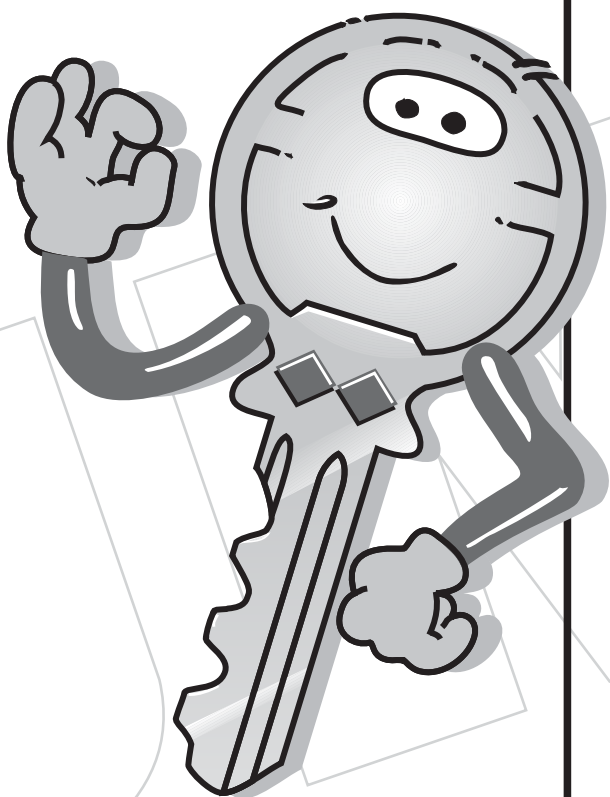

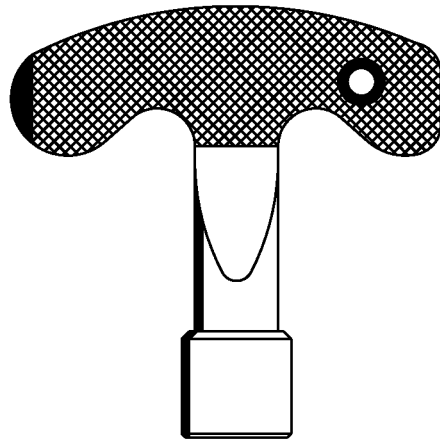

ZAM.



6  
500

7  
501

8  
502

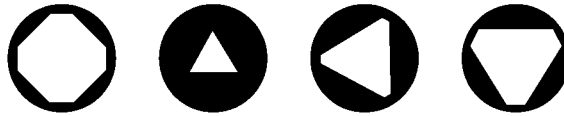

10  
503

6  
504

8  
505

10  
506

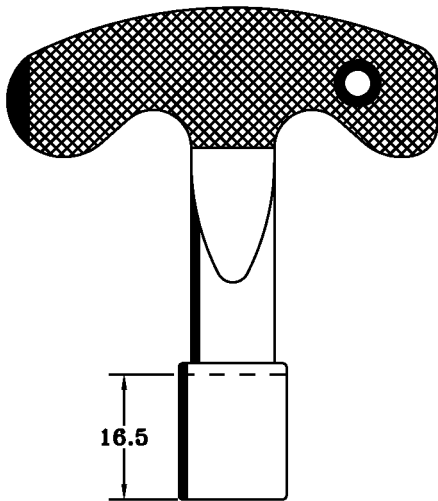

16.5

ZAM.

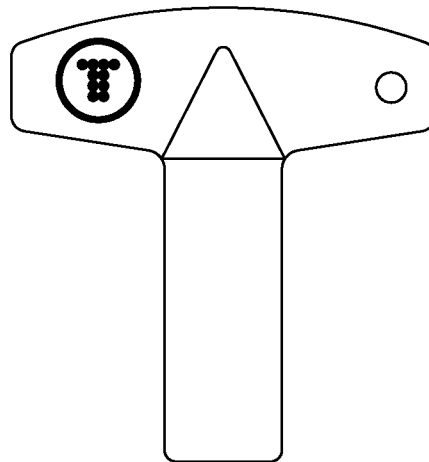

PLAS.



8.5  
507



8  
508



9.5  
509

Copyright by  
Alejandro Altuna S.A.  
2005

**JMA**

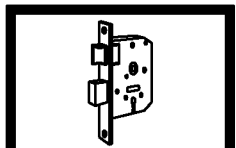

**203**

**PARA-FOR:**

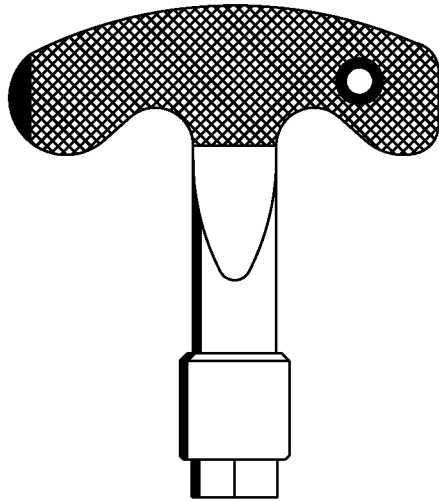

ZAM.

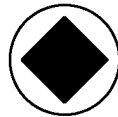

8  
510

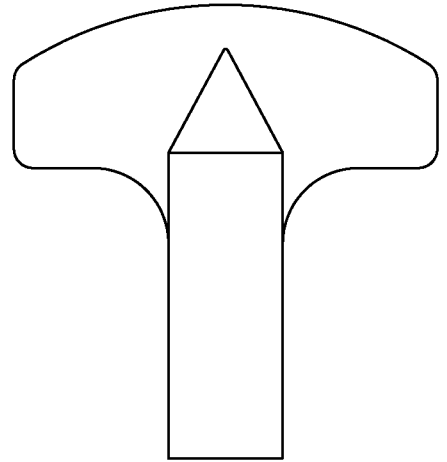

ALU.



8.5  
511

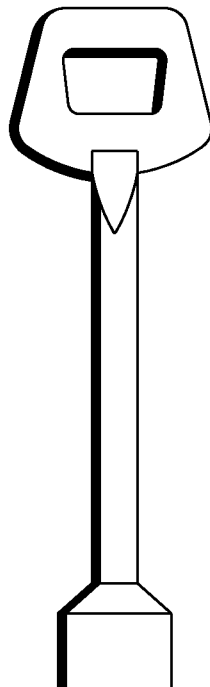

ZAM.



10  
512

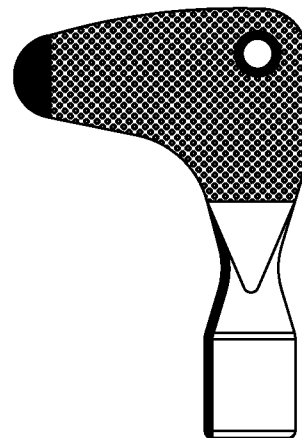

LAT.



8.5  
513  
ORONA

Copyright by  
Alejandro Altuna S.A.  
2005

**JMA**

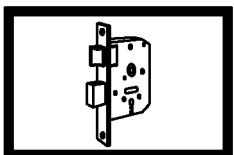

**204**

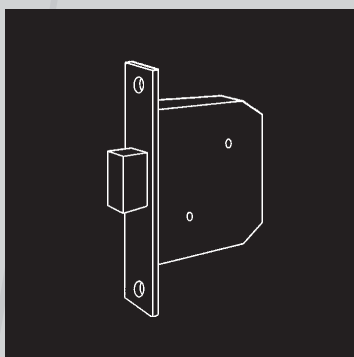

# **JMA**

**LLAVES EN CRUZ**

**GURUTZE-GILTZAK**











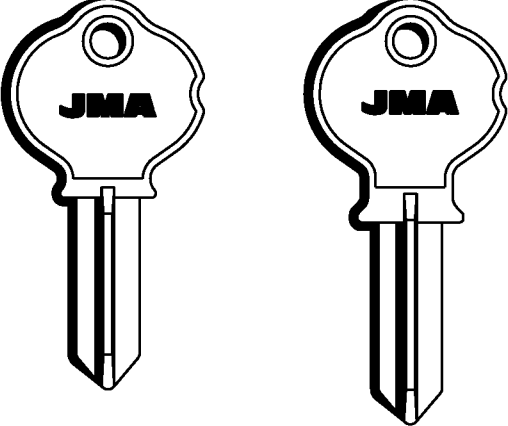

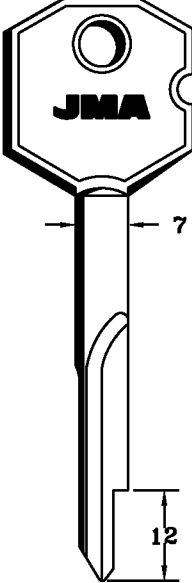
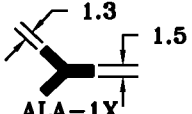
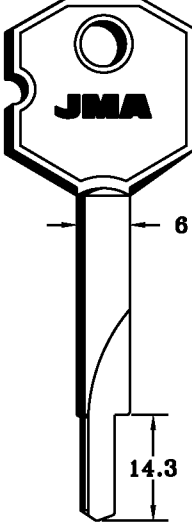
**CRUCIFORM KEYS**

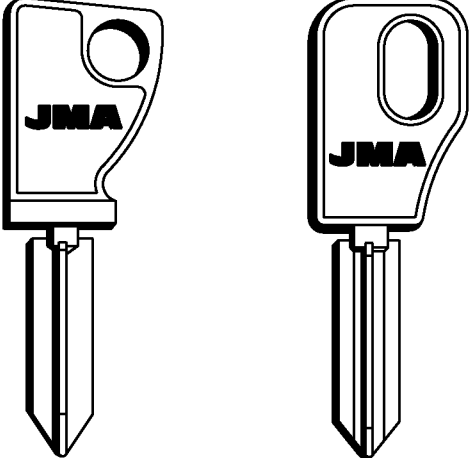
**CLÉS CRUCIFORMES**

**KREUTZSCHLÜSSEL**

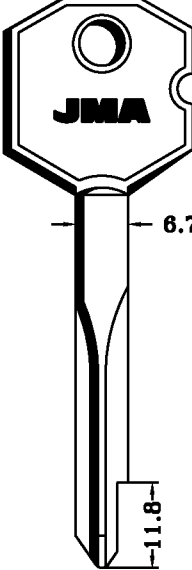
**CHIAVI A CROCE**

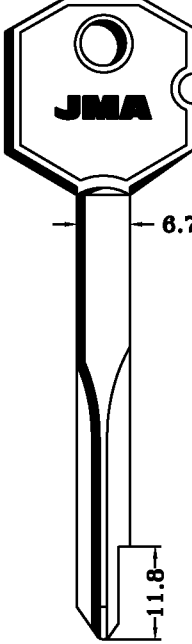
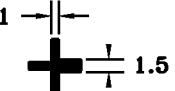

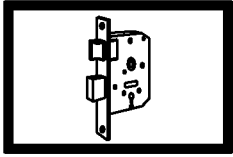
PARA: FOR:	AGC	ALA	BLUMA	<b>PARA-FOR:</b>
  <p>AGD-1X CCF3</p>  <p>AGD-2X CCF3</p>	  <p>ALA-1X</p>	  <p>BLU-1X</p>	<p><b>AGC (P)</b></p> <p><b>ALA (I)</b></p> <p><b>BLUMA (D)</b></p> <p><b>BRICARD (F)</b></p> <p><b>BURG (D)</b></p>	
PARA: FOR:	BRICARD	BURG		
  <p>BRI-1X</p>  <p>BRI-2X</p>  <p>BRI-3X</p>	  <p>BUR-1X 75mm TRIOVING</p>	  <p>BUR-2X 85mm</p>	<p>Copyright by Alejandro Altuna S.A. 2005</p>   <p><b>207</b></p>	

**PARA-FOR:**

**BURG (D)**

**CCF (P)**

**PARA:  
FOR:**

**BURG**

**CCF**

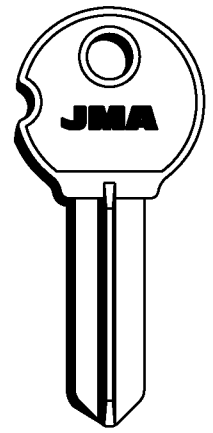
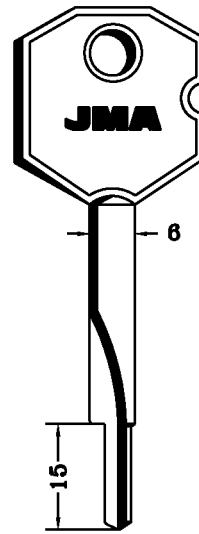
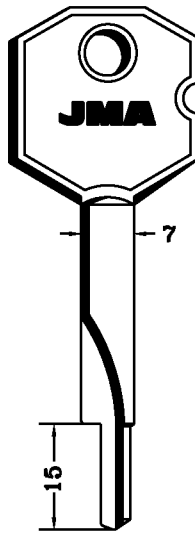
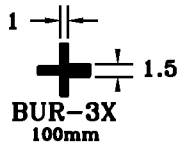
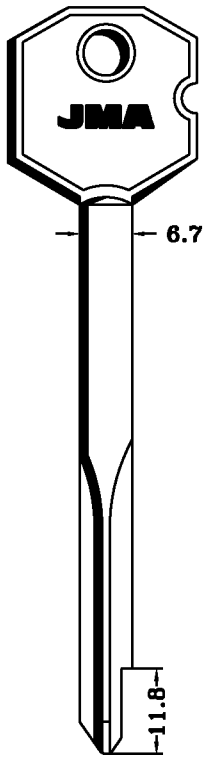

**PARA:  
FOR:**

**CCF**

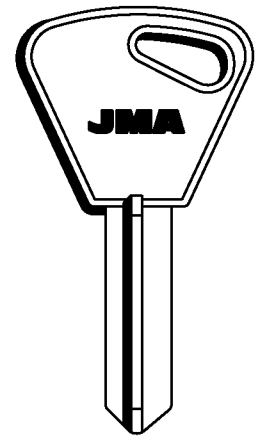
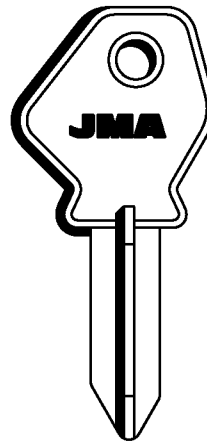
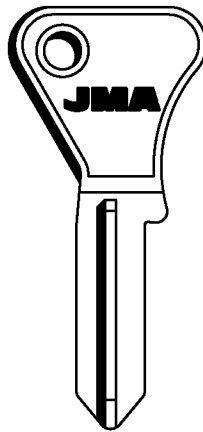
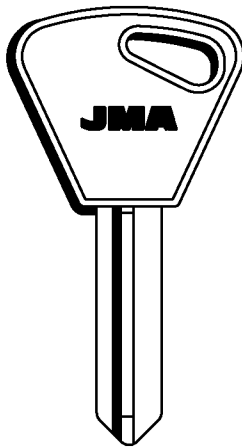





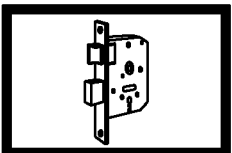



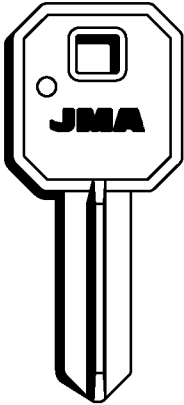

Copyright by  
Alejandro Altuna S.A.  
2005

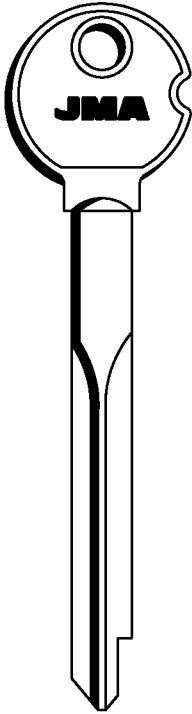
**JMA**

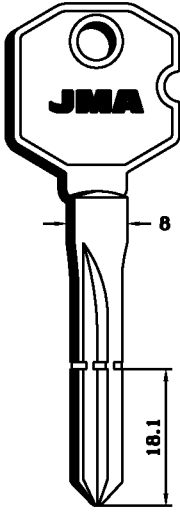
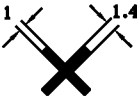
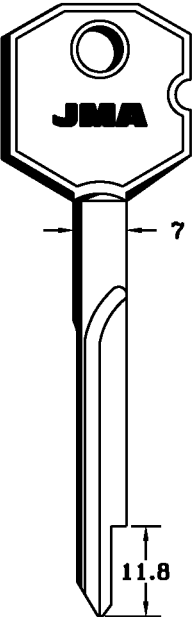
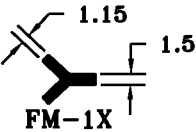
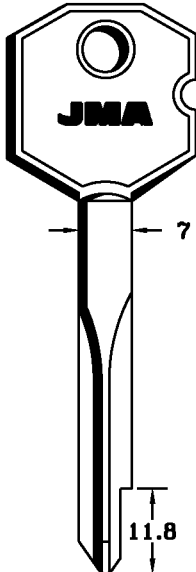
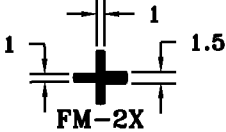
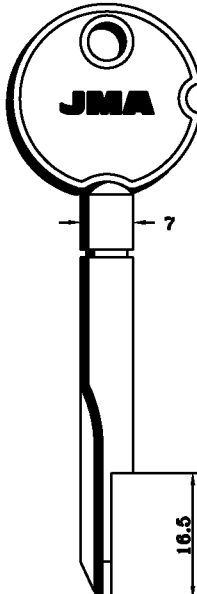

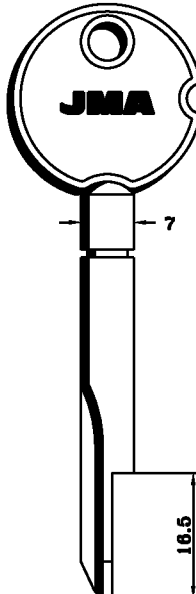
**208**

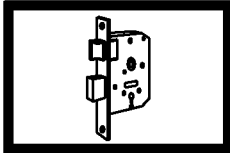
PARA: FOR:	CIFIAL	CRC CAMBOA	DEBEAURAIN	DOOR LOCK <b>PARA-FOR:</b>	
	   CIF-1X CCF4	   CRC-1X	   DEB-1X	   DOL-1X	<b>CIFIAL (P)</b> <b>CRC CAMBOA (P)</b> <b>DEBEAURAIN (F)</b> <b>DOOR LOCK</b> <b>FIAM (I)</b> <b>FRIPA (D)</b>
PARA: FOR:	FIAM		FRIPA		
	   FM-1X	   FM-2X	   FRI-1X	   FRI-2X	<p>Copyright by Alejandro Altuna S.A. 2005</p>   <b>209</b>

ATENCION:Concernlente a las marcas y denominaciones comerciales ver nota en indice.ATTENTION:Concerning the marks and commercial denominations see note in index.  
 ATTENTION:Concernant les marques et denominations commerciales voir la note dans l'index.ACHTUNG:Beziehen auf die marke und handelsname sehen sie die notiz im index.

**PARA-FOR:**

**PARA:** GERA  
**FOR:**

**HELCO KFV**

**GERA (D)**  
**HELCO KFV (D)**  
**KRESTI (RUS)**

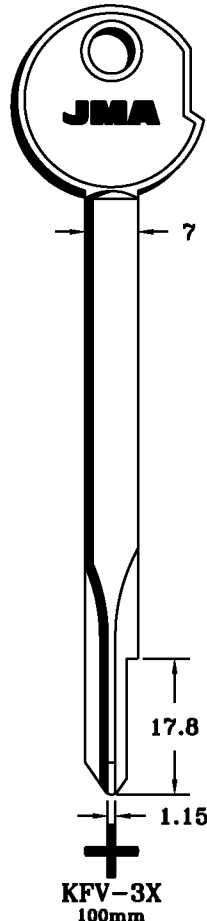
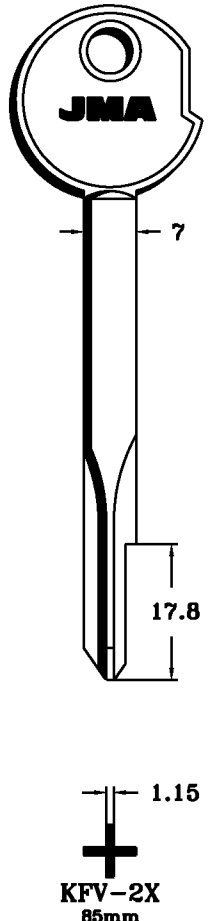
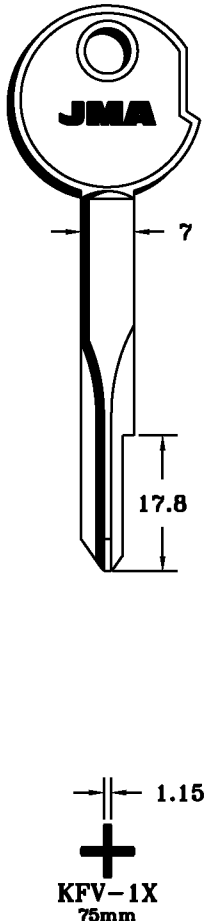
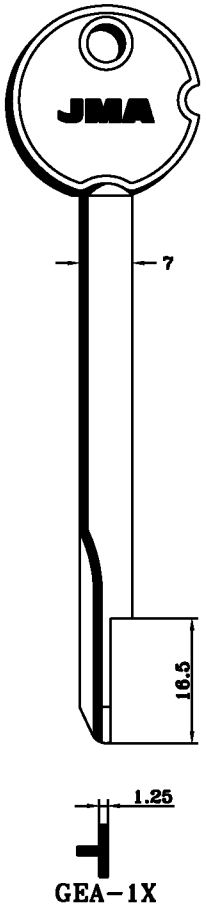

**PARA:** KRESTI  
**FOR:**

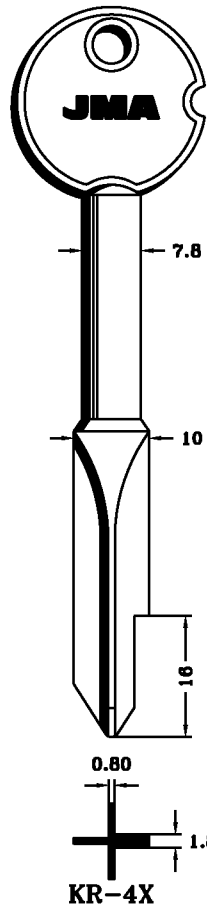
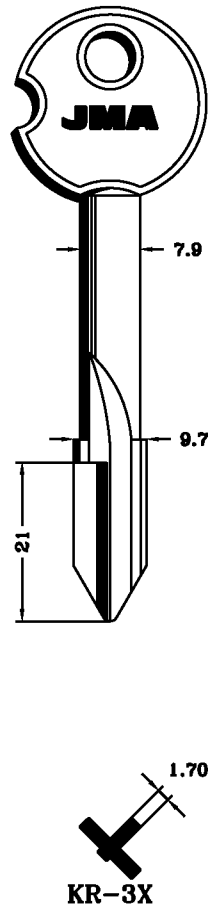
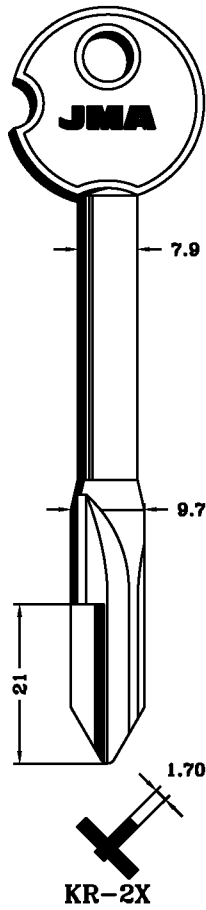
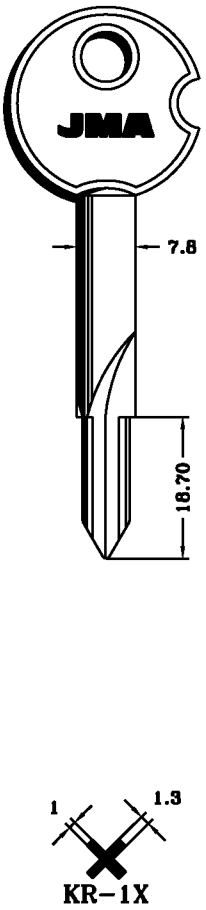

Copyright by Alejandro Altuna S.A. 2005

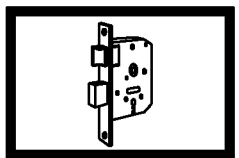

**210**

ATENCION:Concerniente a las marcas y denominaciones comerciales ver nota en indice.ATTENTION:Concerning the marks and commercial denominations see note in index. ATTENTION:Concernant les marques et denominations commerciales voir la note dans l'index.ACHTUNG:Beziehen auf die marke und handelsname sehen sie die notiz im index.

PARA:  
FOR:

### KRESTI

PARA-FOR:

KRESTI (RUS)

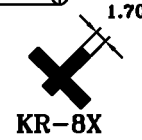
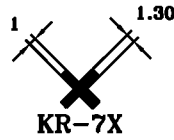
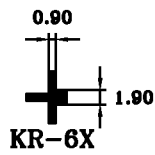
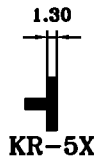
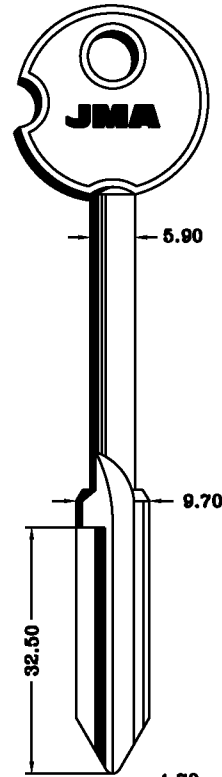
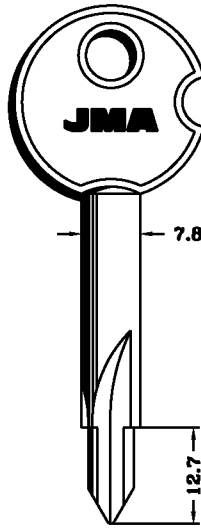
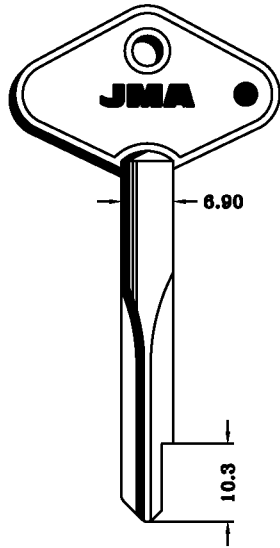
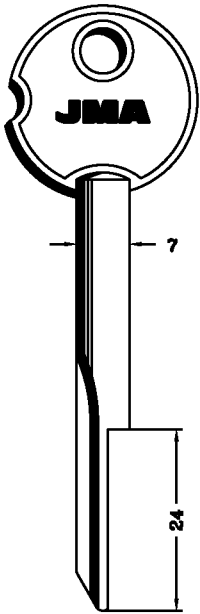

PARA:  
FOR:

### KRESTI

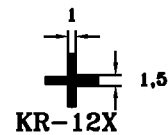
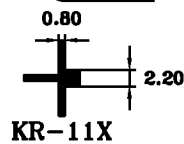
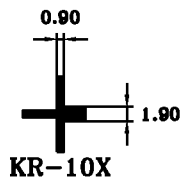
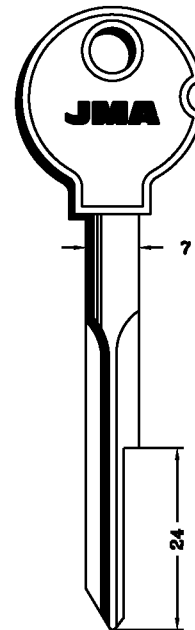
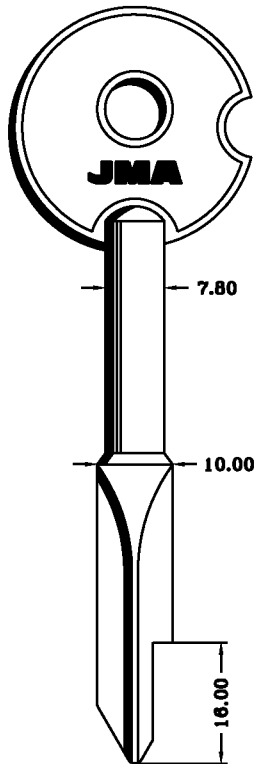
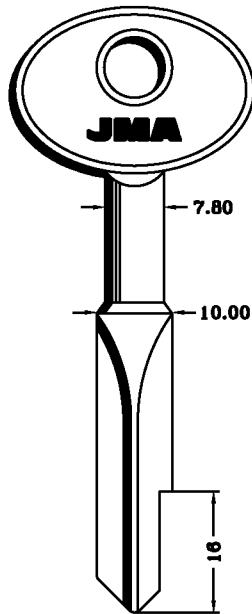
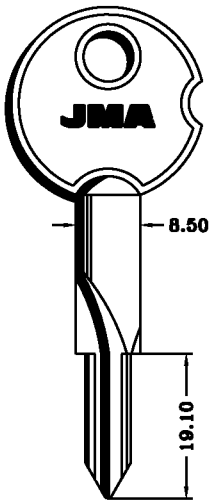

Copyright by  
Alejandro Altuna S.A.  
2005

JMA

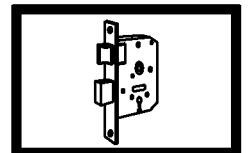

211

**PARA-FOR:**

PARA:  
FOR:

**KRESTI**

**KRESTI (RUS)**

**MAFOR (F)**

**MINI MOLA (P)**

**MOREAUX (F)**

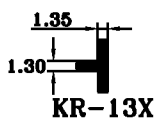
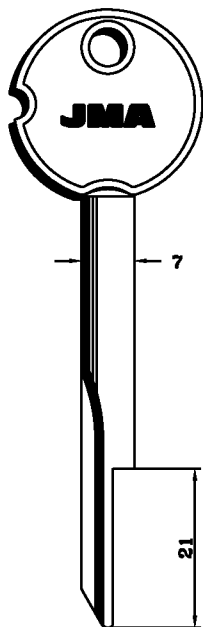

**KR-13X**

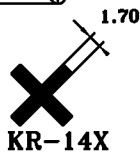
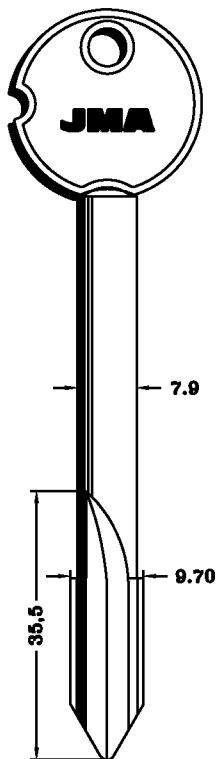

**KR-14X**

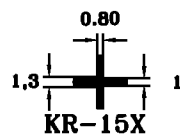
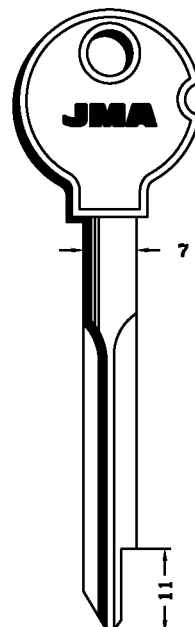

**KR-15X**

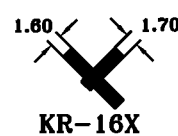
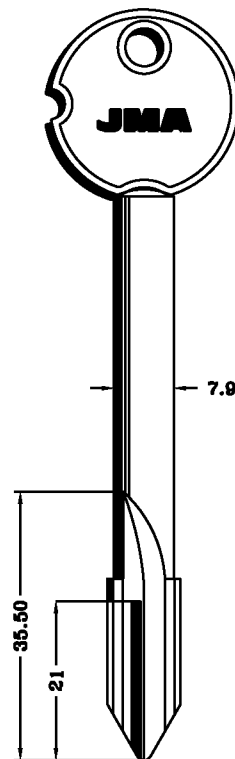

**KR-16X**

PARA: KRESTI  
FOR: KRESTI

**MAFOR**

**MINI MOLA**

**MOREAUX**

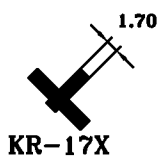
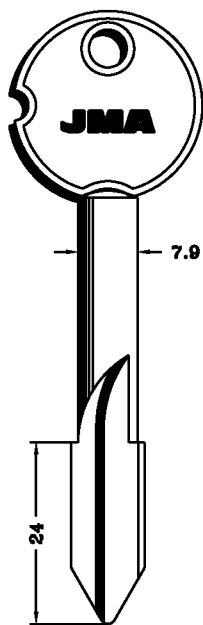

**KR-17X**

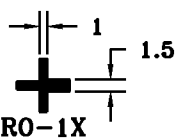
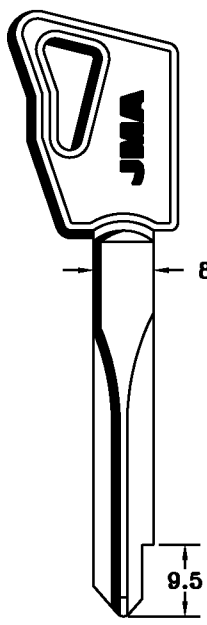

**RO-1X**

**RONIS-SOS**



**MM-1X**  
CCF7  
ANA

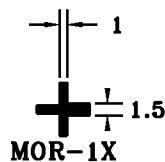
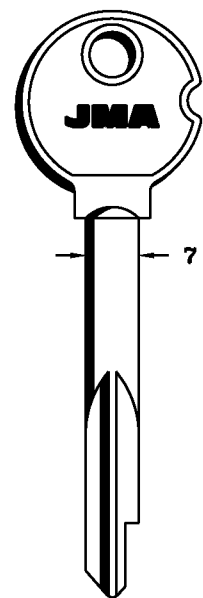







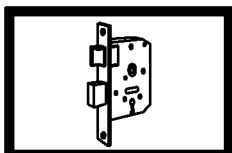

**MOR-1X**

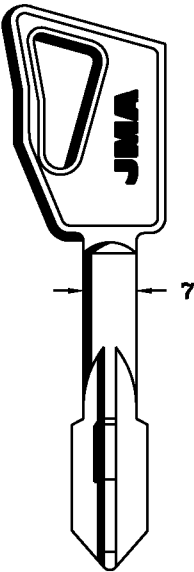
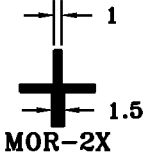
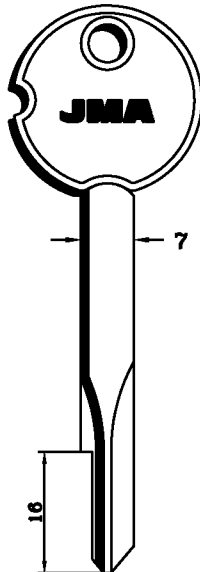
Copyright by  
Alejandro Altuna S.A.  
2005

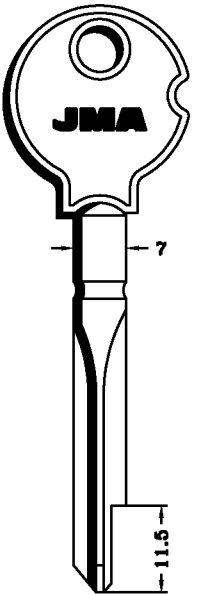
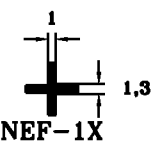
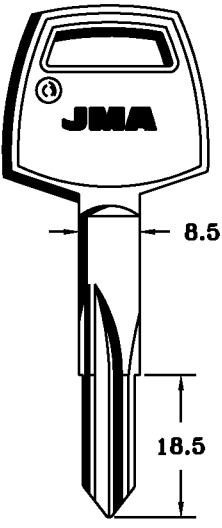
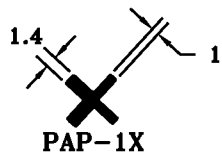
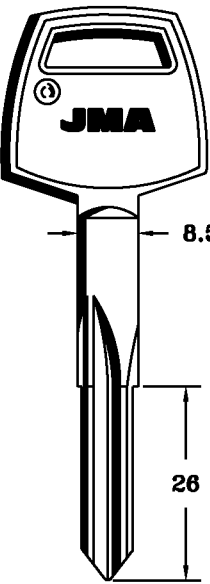
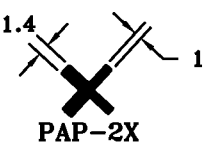
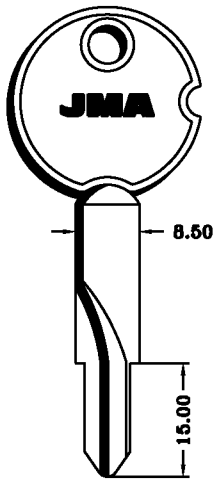
**JMA**

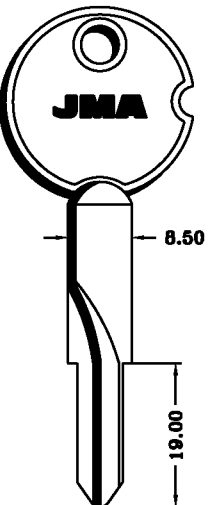

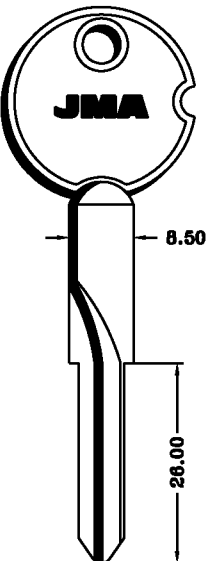
**212**

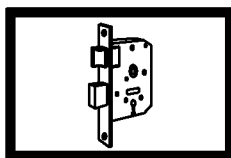
PARA: FOR: MOREAUX	NABOB	NEMEF	PAPAIZ	<b>PARA-FOR:</b>
 <p>7</p>  <p>MOR-2X</p>	 <p>7</p> <p>16</p>  <p>NAB-1X</p>	 <p>7</p> <p>11.5</p>  <p>NEF-1X</p>	 <p>8.5</p> <p>18.5</p>  <p>PAP-1X</p>	<p><b>MOREAUX (F)</b></p> <p><b>NABOB (IL)</b></p> <p><b>NEMEF (D)</b></p> <p><b>PAPAIZ (BR)</b></p> <p><b>TUFF (HK)</b></p>
PARA: FOR: PAPAIZ	TUFF			
 <p>8.5</p> <p>26</p>  <p>PAP-2X</p>	 <p>8.50</p> <p>15.00</p>  <p>TUF-1X</p>	 <p>8.50</p> <p>19.00</p>  <p>TUF-2X</p>	 <p>8.50</p> <p>26.00</p>  <p>TUF-3X</p>	<p>Copyright by Alejandro Altuna S.A. 2005</p>   <p style="font-size: 2em; font-weight: bold; border: 2px solid black; padding: 5px; display: inline-block;">213</p>

**PARA-FOR:**

**PARA: UNIVERSAL**  
**FOR:**

**YALE BKS**

**UNIVERSAL**

**YALE BKS  
(I) (D)**

**YALE (I)**

**ZEISS IKON  
(D)**

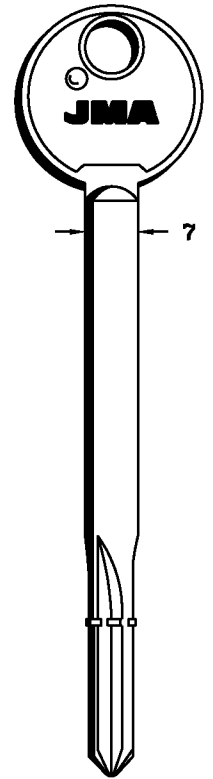
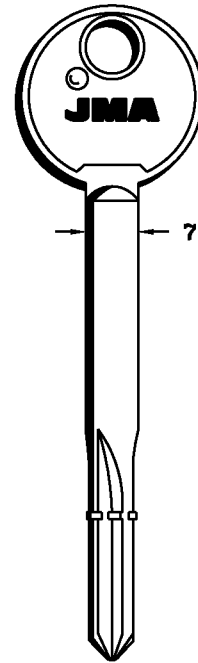
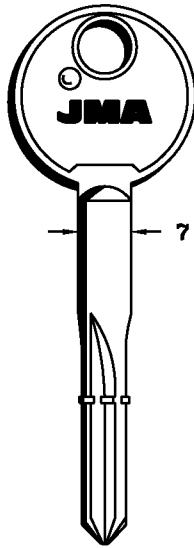
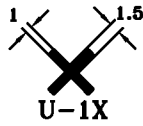
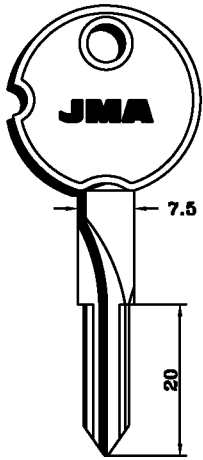

**PARA:  
FOR:**

**YALE**

**ZEISS IKON**

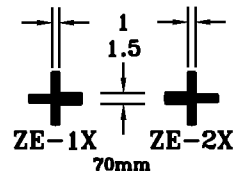
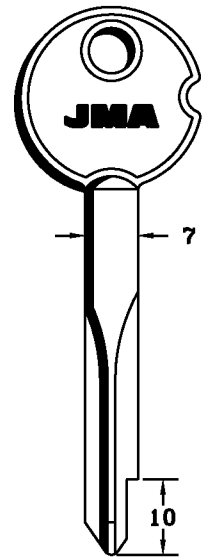
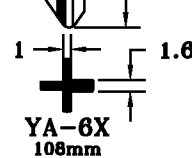
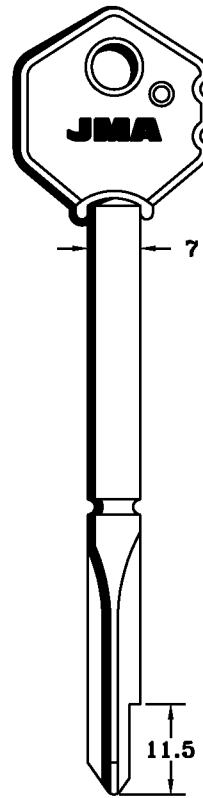
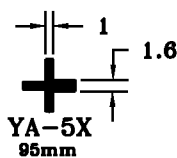
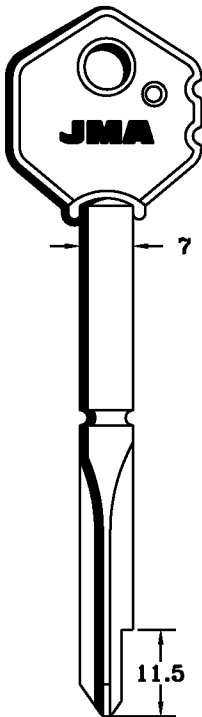
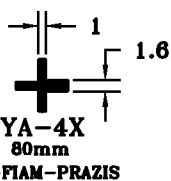
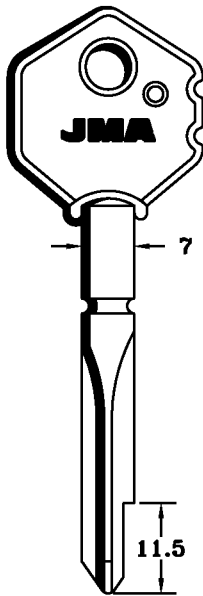

Copyright by  
Alejandro Altuna S.A.  
2005

**JMA**

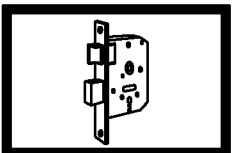

**214**

PARA:  
FOR:

# ZEISS IKON

PARA-FOR:

**ZEISS IKON  
(D)**

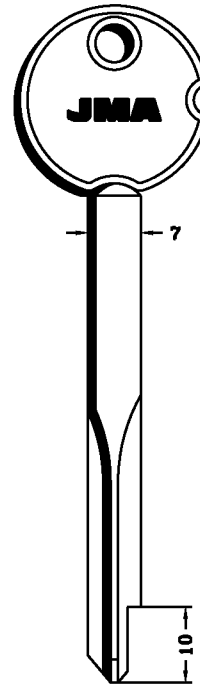
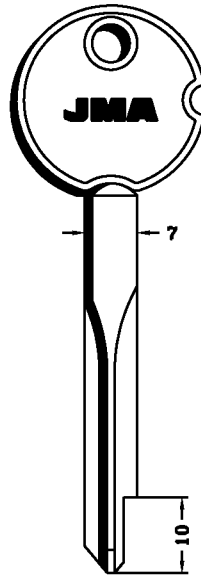
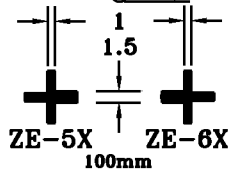
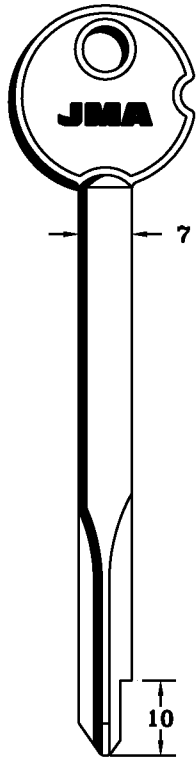
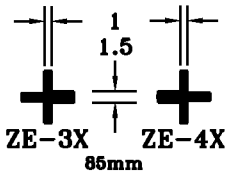
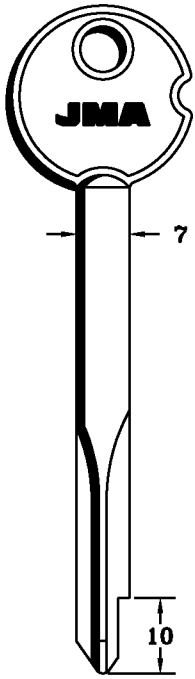

PARA:  
FOR: ZEISS IKON

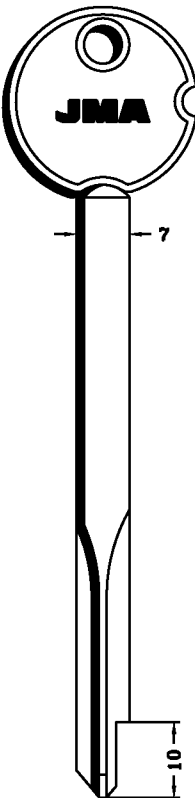

Copyright by  
Alejandro Altuna S.A.  
2005

**JMA**

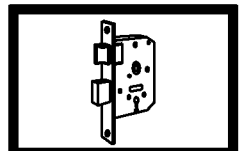

**215**

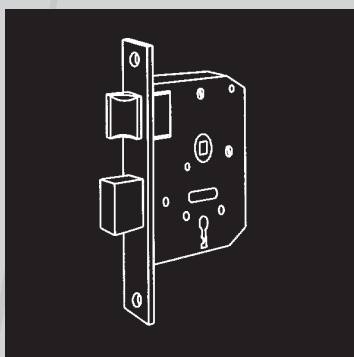

# **JMA**

**LLAVES DE GORJA ACERO DULCE**

**ALTZAIRU GOZOZKO GORJA-GILTZA**

**MILD STEEL BIT KEYS**

**CLÉS À GORGES EN ACIER DOUX**

**CHUBBSCHLÜSSEL AUS WEICHSTAHL**

**CHIAVI A MAPPA DI ACCIAIO**

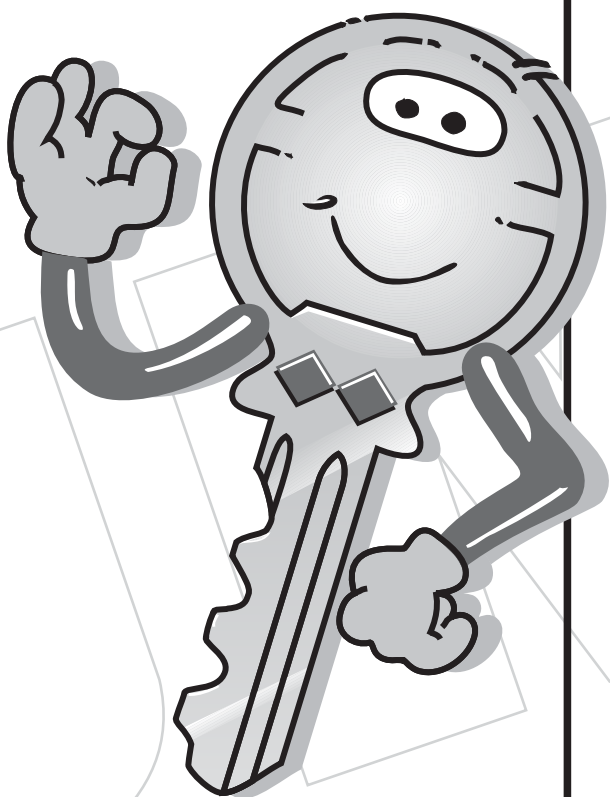

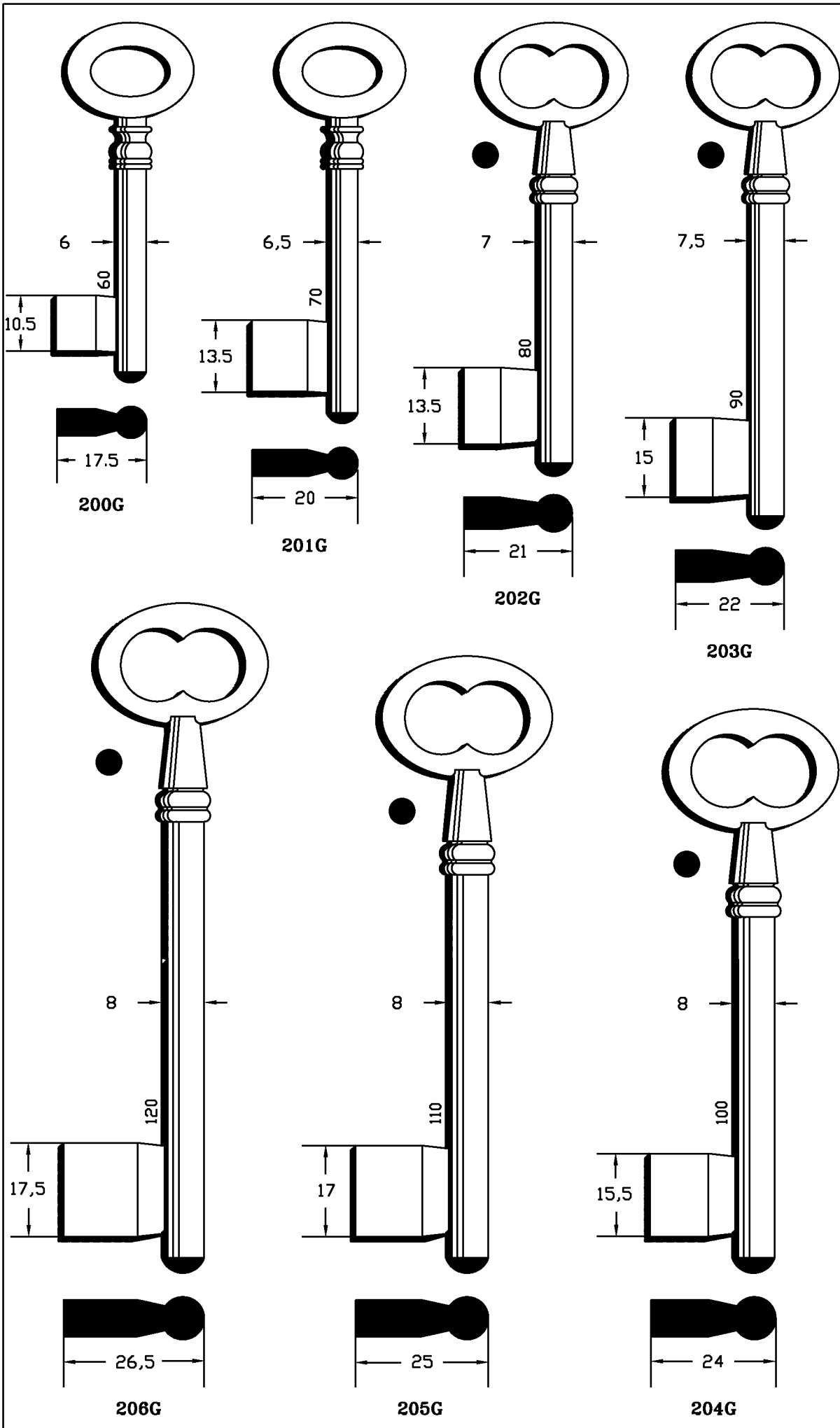

Copyright by  
Alejandro Altuna S.A.  
2005

**JMA**

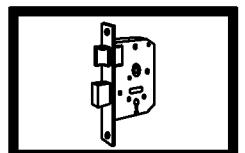

**219**

**PARA-FOR:**

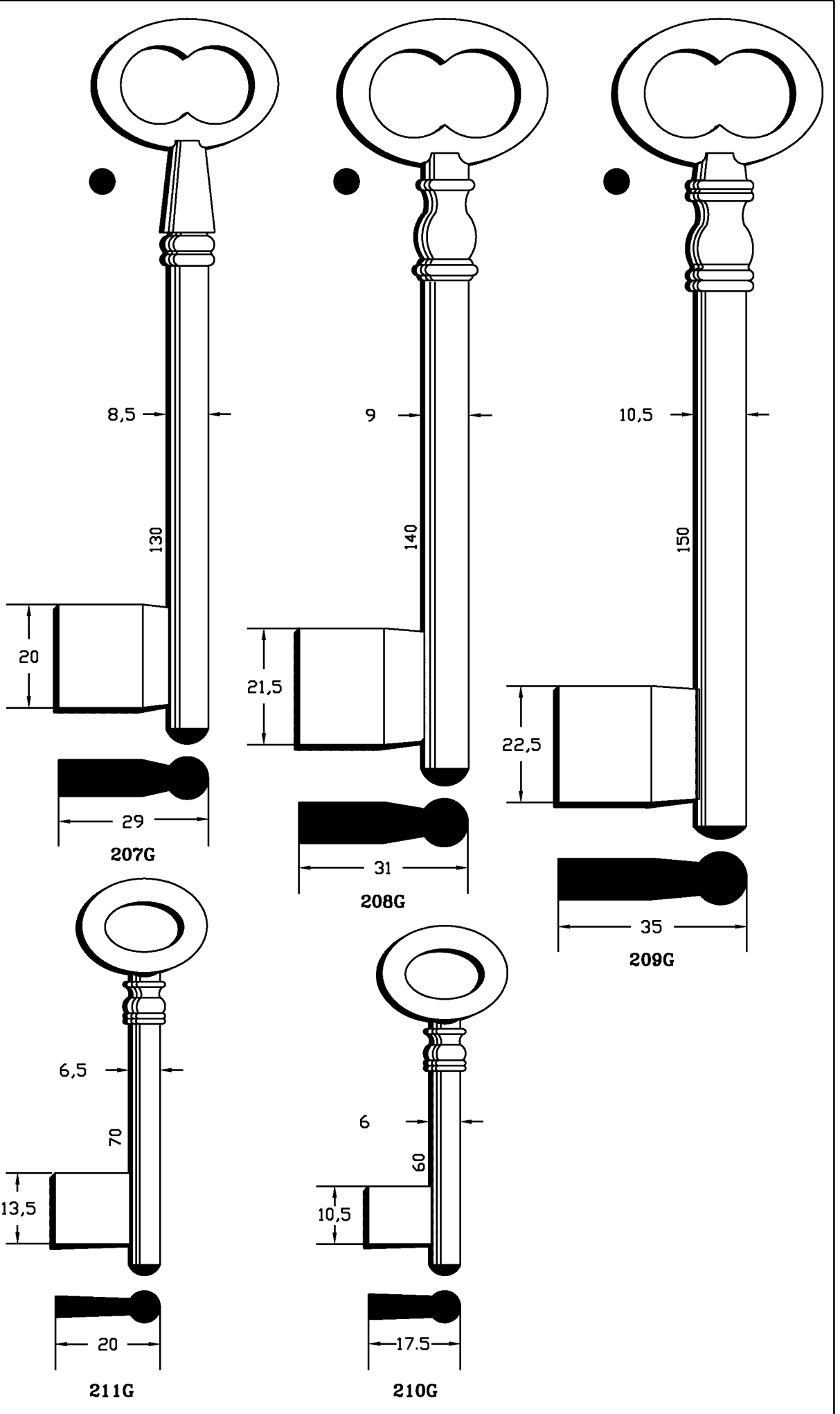

Copyright by  
Alejandro Altuna S.A.  
2005  
**JMA** 

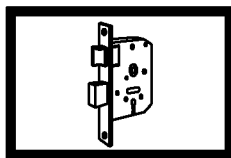

**220**

ATENCION:Concerniente a las marcas y denominaciones comerciales ver nota en indice.ATTENTION:Concerning the marks and commercial denominations see note in index. ATTENTION:Concernant les marques et denominations commerciales voir la note dans l'index.ACHTUNG:Beziehen auf die marke und handelsname sehen sie die notiz im index.

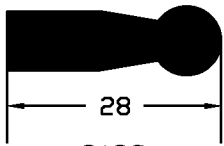
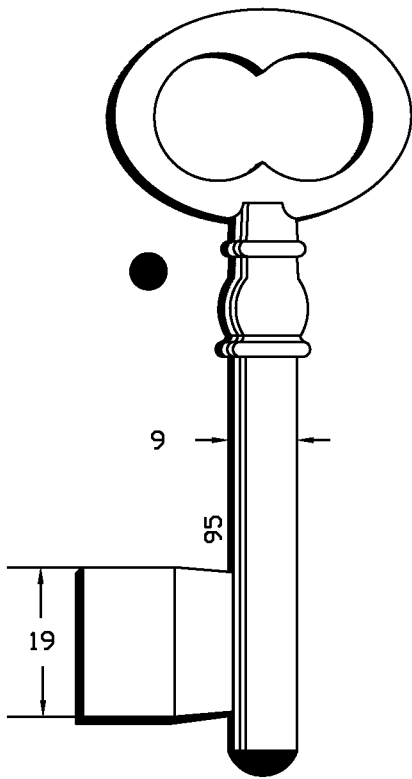

**212G**

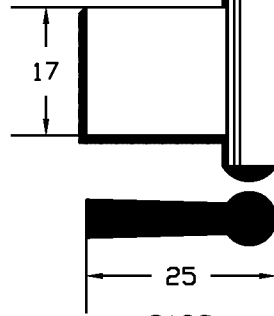
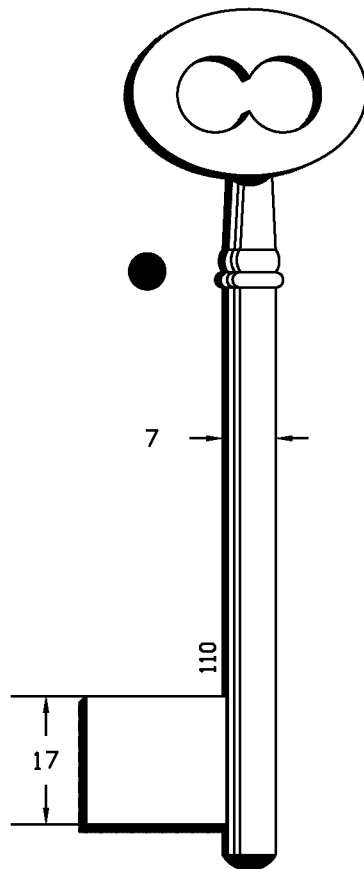

**213G**

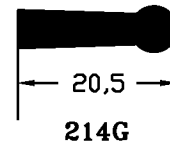
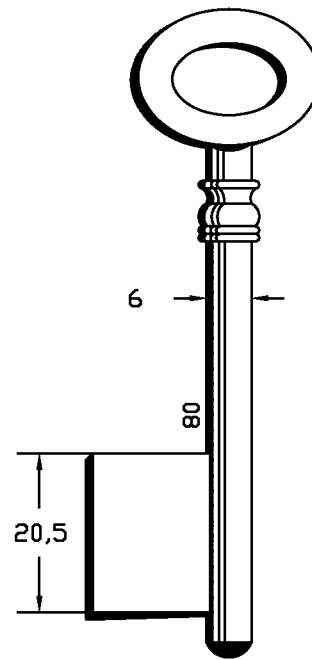

**214G**

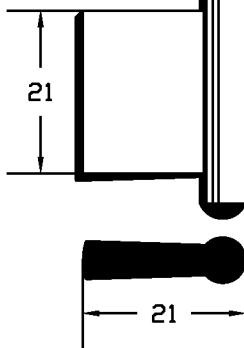
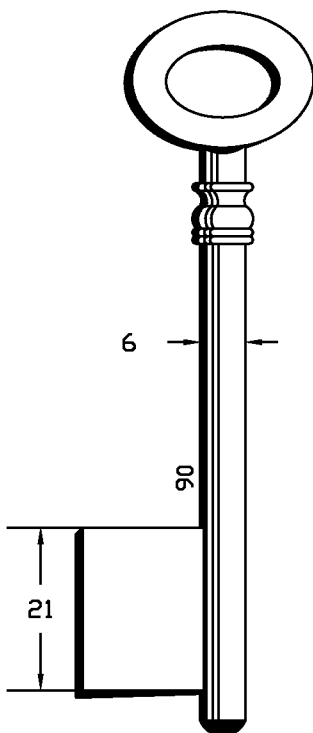

**215G**

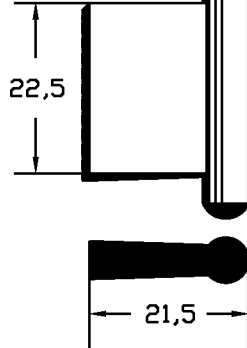
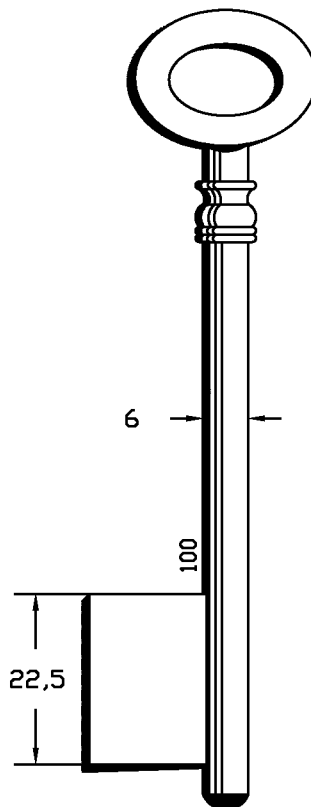

**216G**

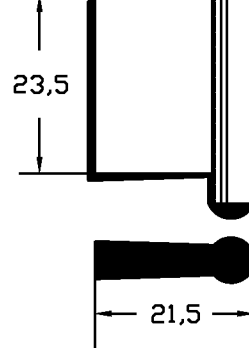
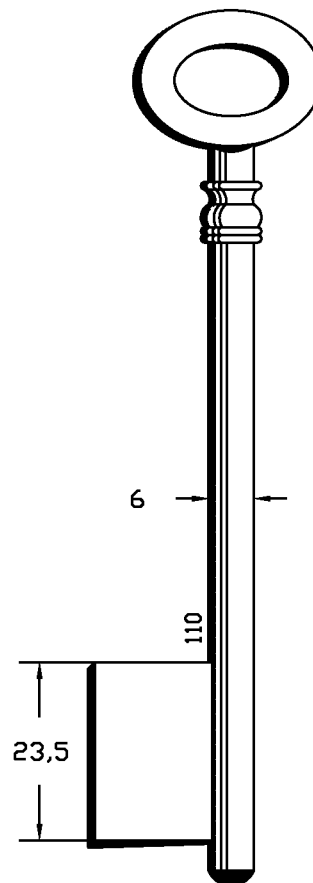

**217G**

Copyright by  
Alejandro Altuna S.A.  
2005

**JMA**

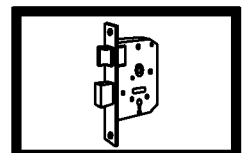

**221**

**PARA-FOR:**

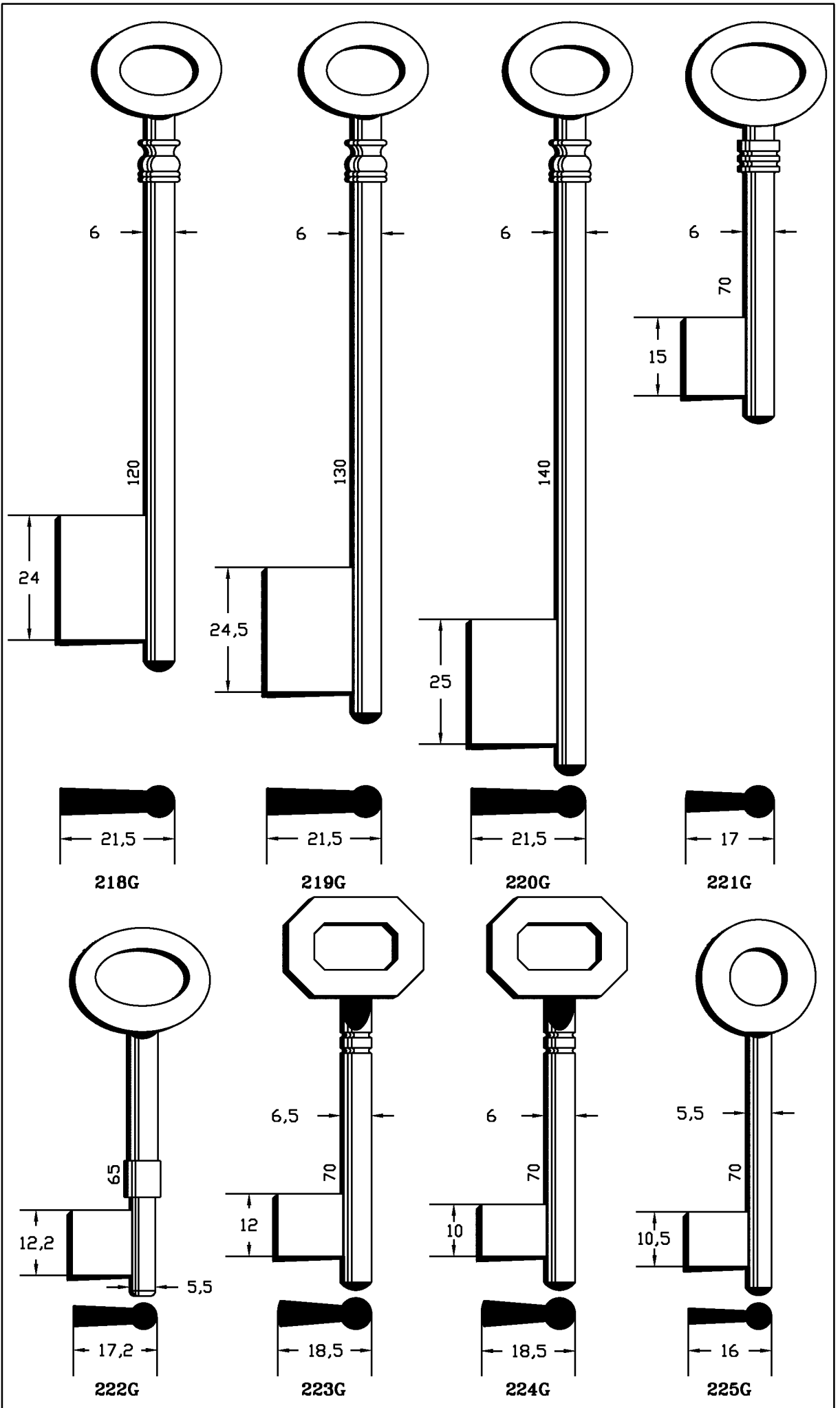

Copyright by  
Alejandro Altuna S.A.  
2005

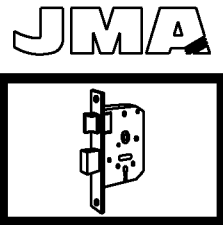

**222**

ATENCION:Concerniente a las marcas y denominaciones comerciales ver nota en indice.ATTENTION:Concerning the marks and commercial denominations see note in index. ATTENTION:Concernant les marques et denominations commerciales voir la note dans l'index.ACHTUNG:Beziehen auf die marke und handelsname sehen sie die notiz im index.

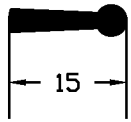
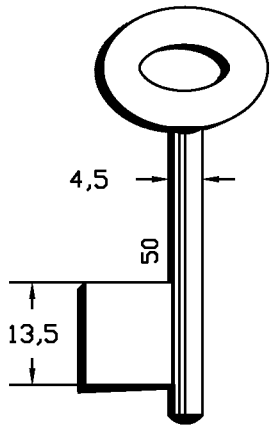

**226G**

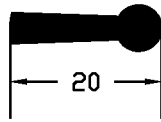
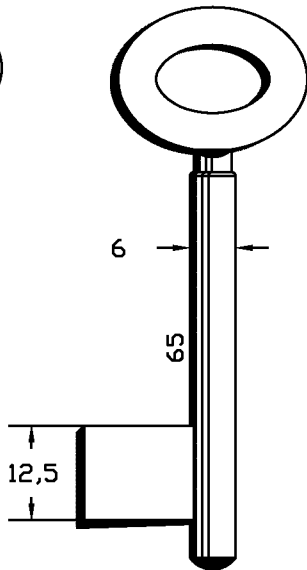

**227G**

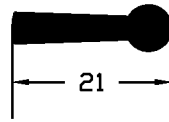
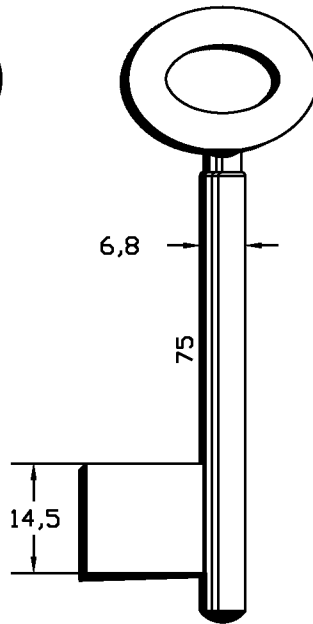

**228G**

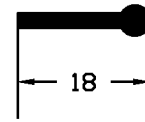
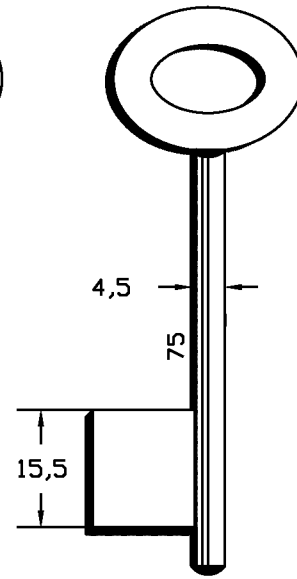

**229G**

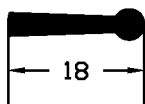
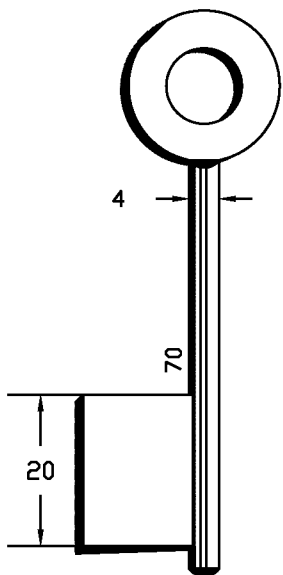

**230G**

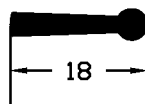
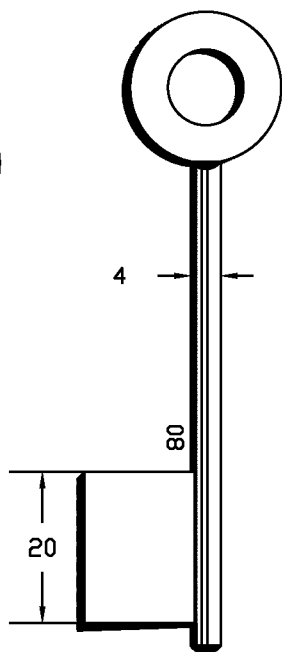

**231G**

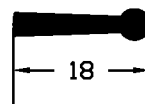
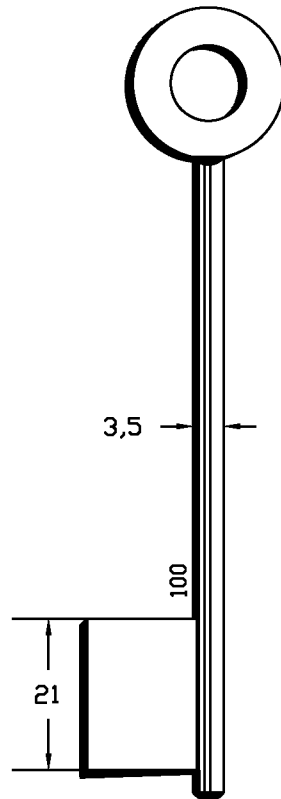

**232G**

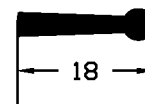
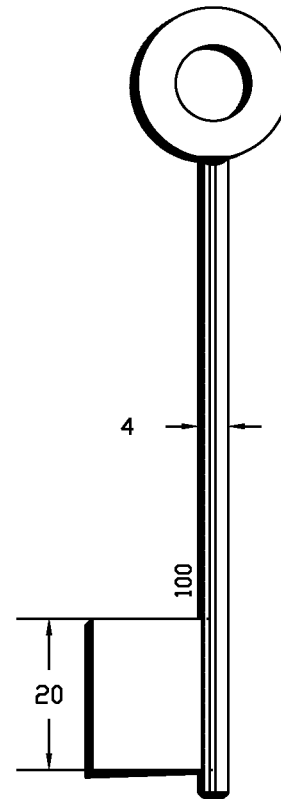

**233G**

Copyright by  
Alejandro Altuna S.A.  
2005

**JMA**

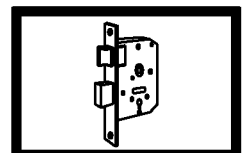

**223**

**PARA-FOR:**  
**BOINAITI (I)**

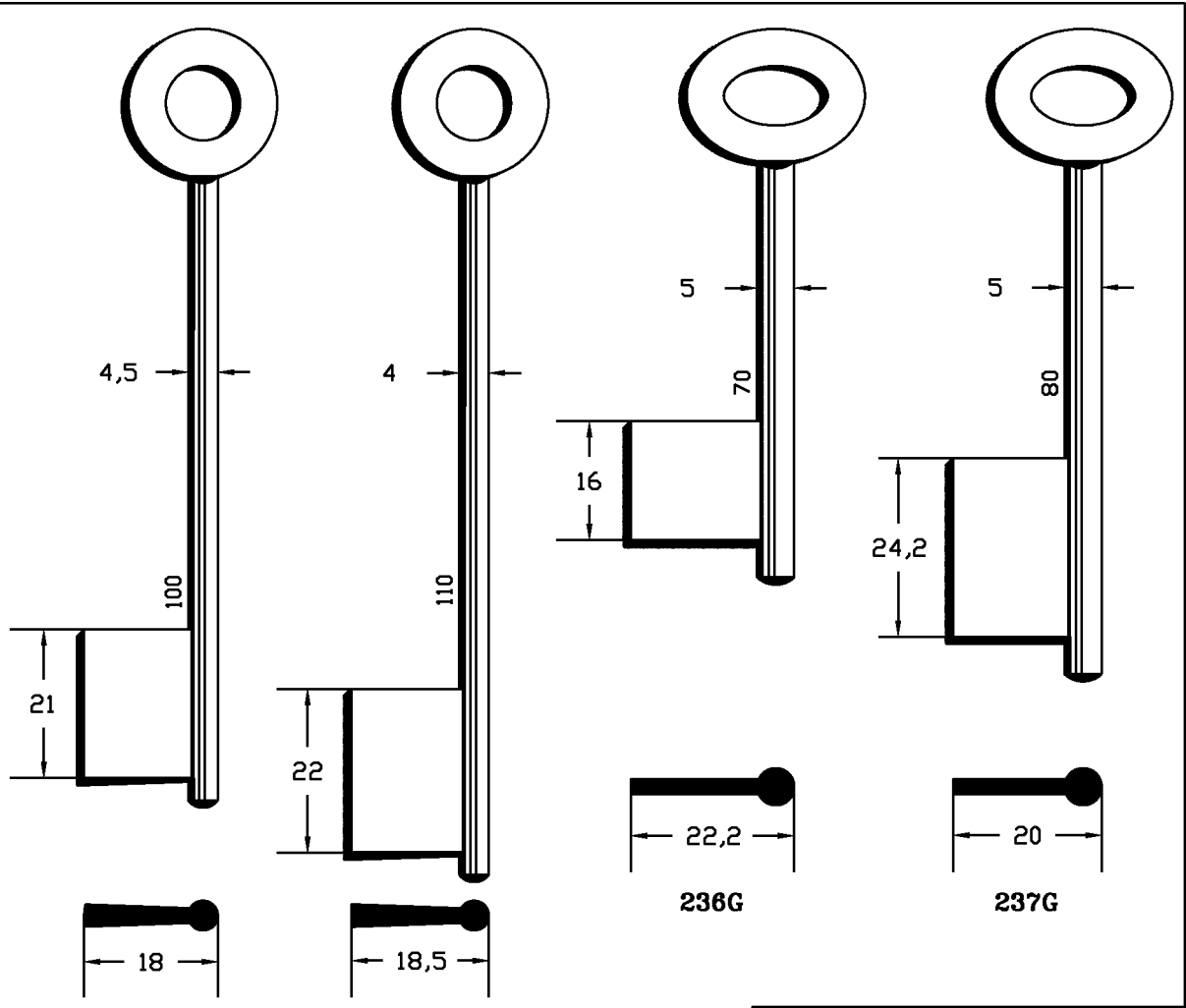

234G

235G

236G

237G

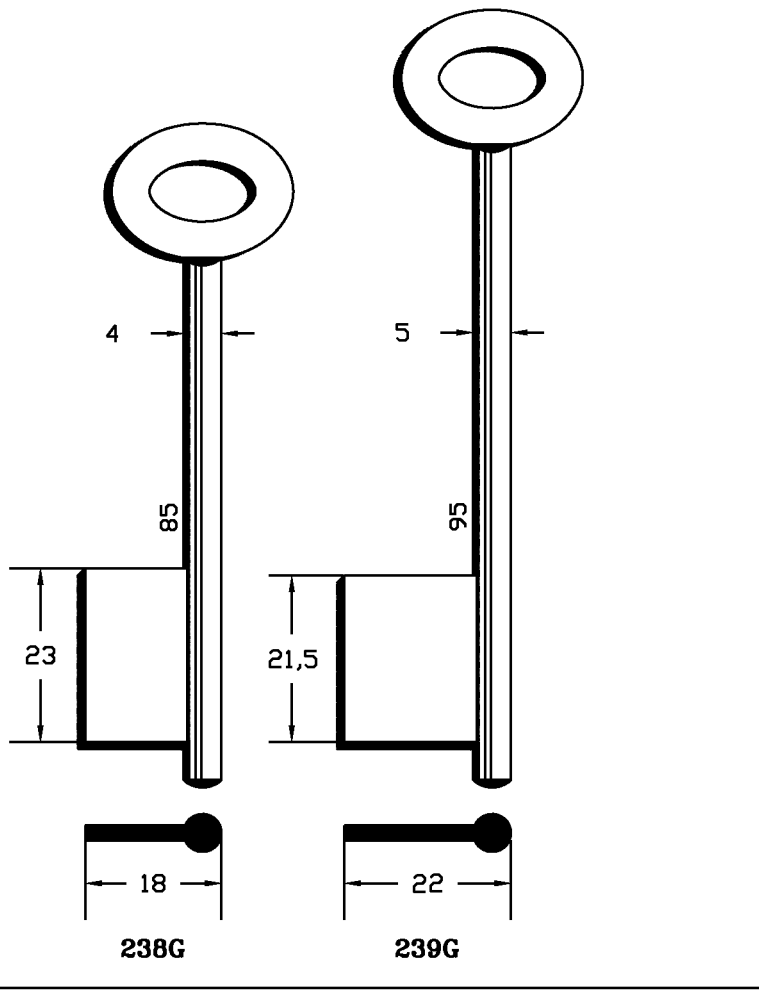

238G

239G

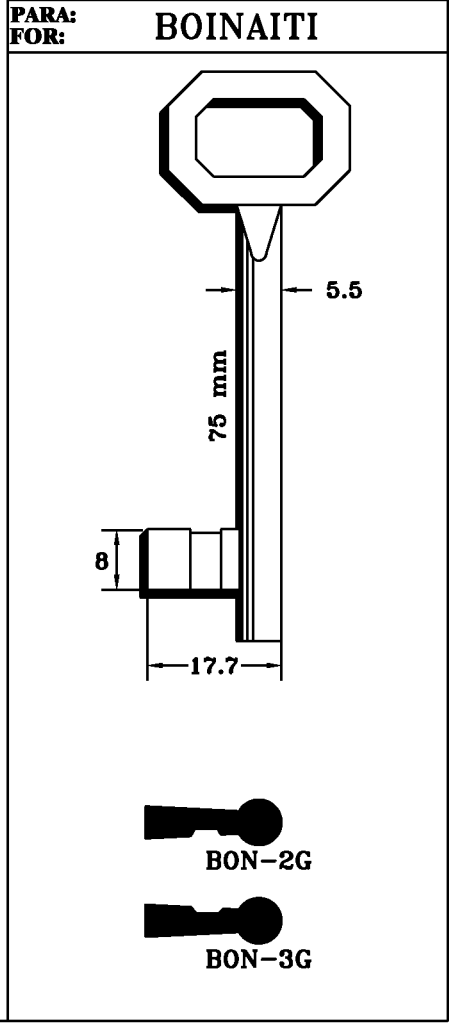

BON-2G

BON-3G

Copyright by  
Alejandro Altuna S.A.  
2005  
**JMA**

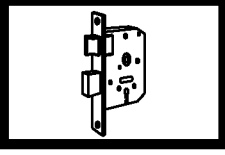

**224**

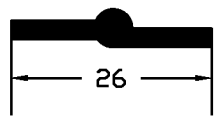
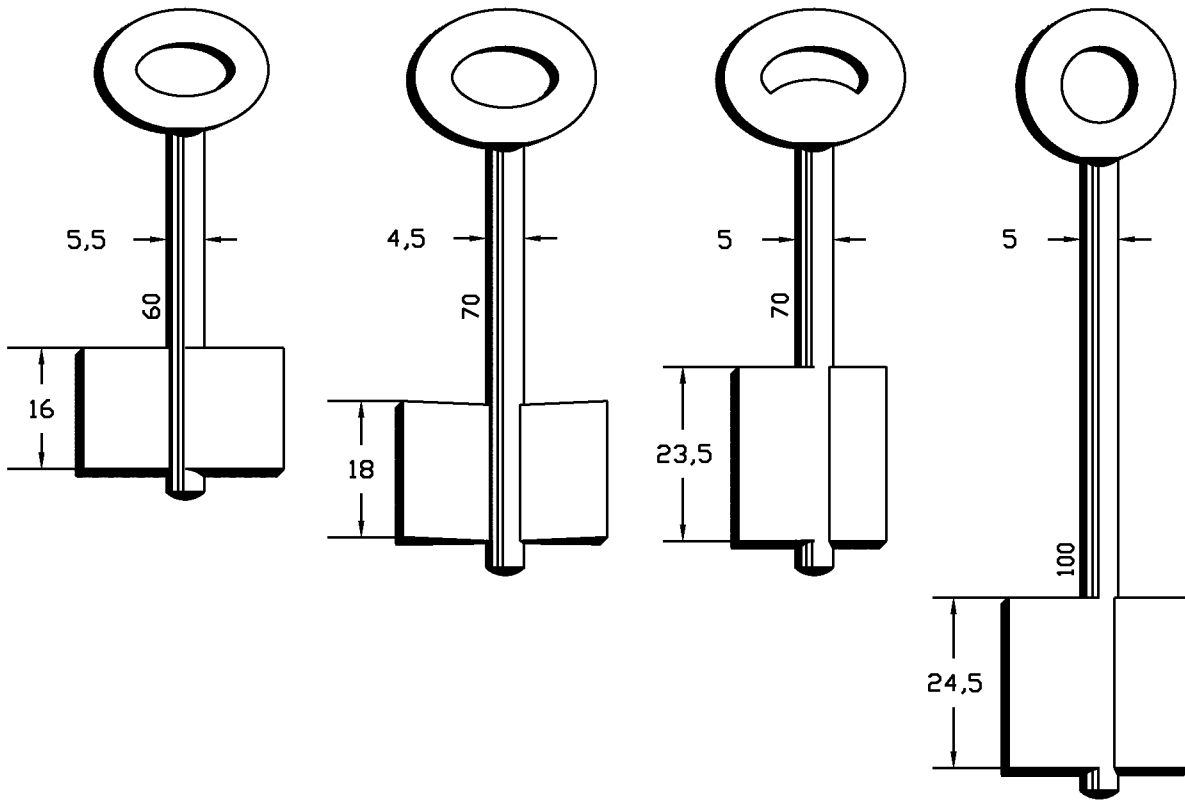

**600G**

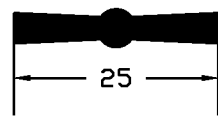

**601G**

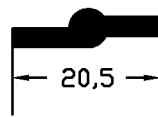

**602G**

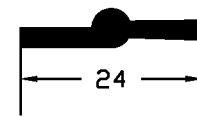

**603G**

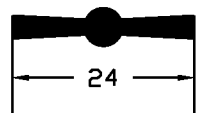
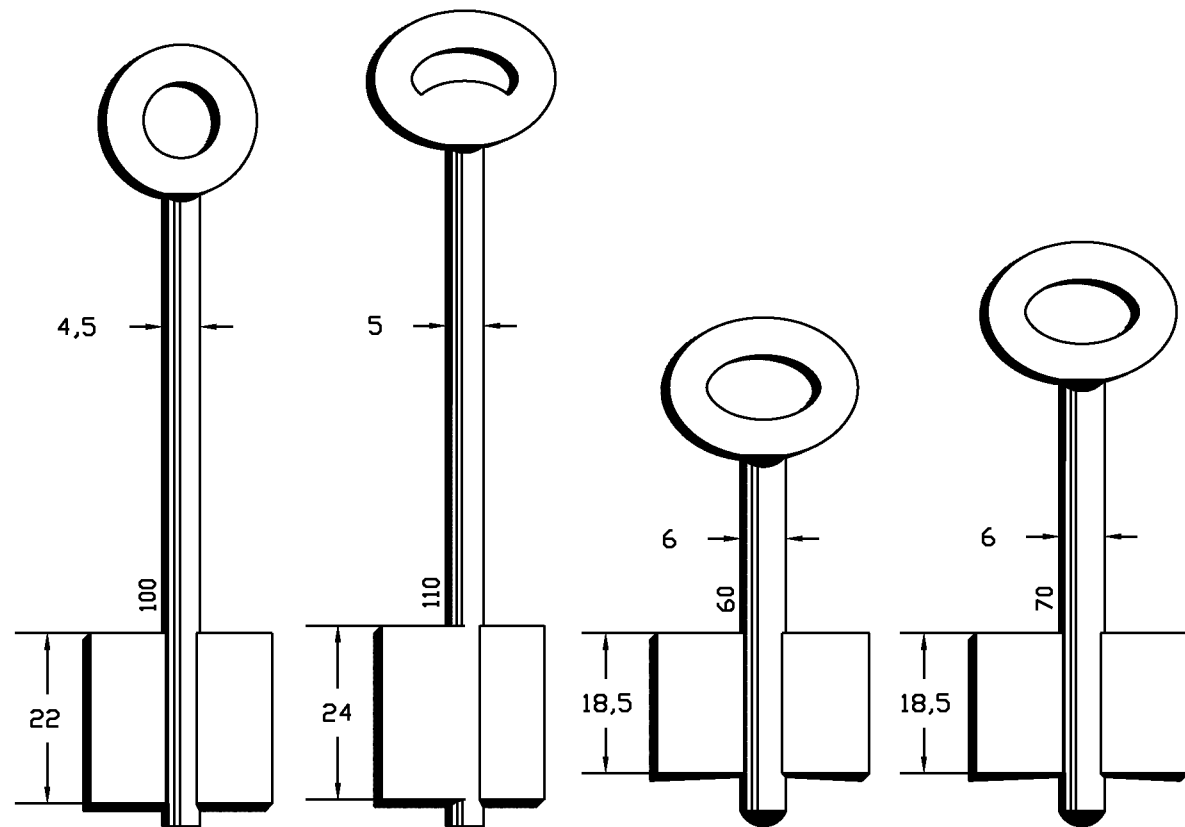

**604G**

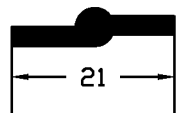

**605G**

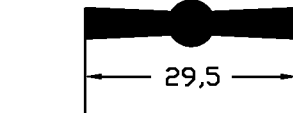

**606G**

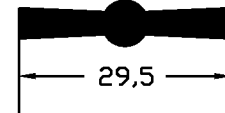

**607G**

Copyright by  
Alejandro Altuna S.A.  
2005

**JMA**

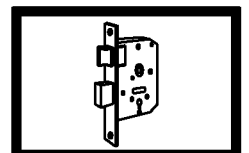

**225**

**PARA-FOR:**

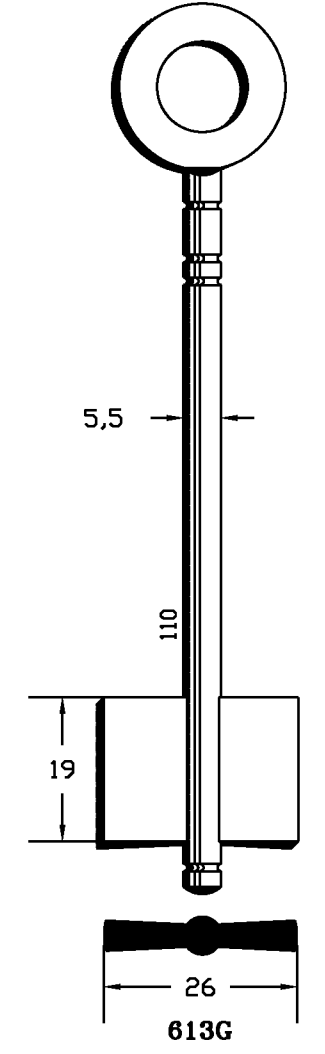
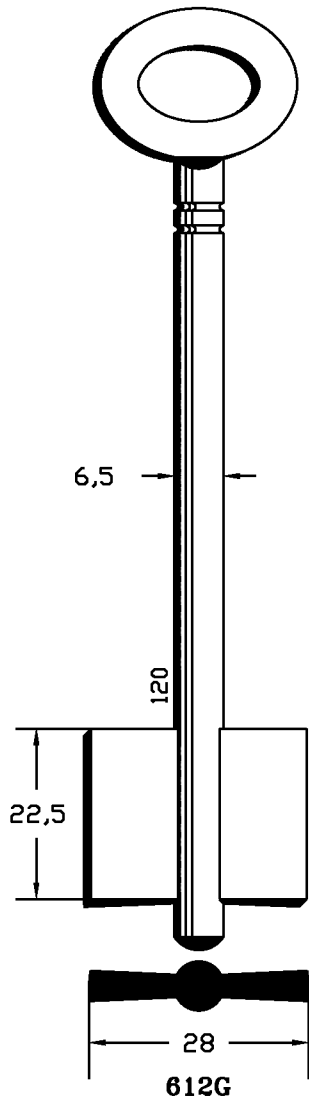
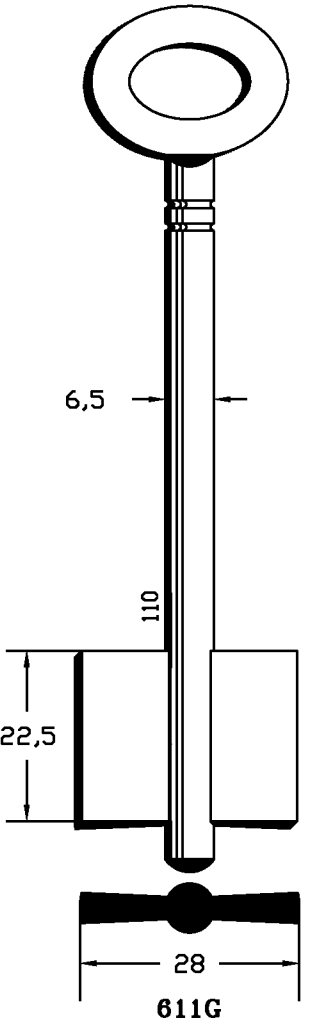
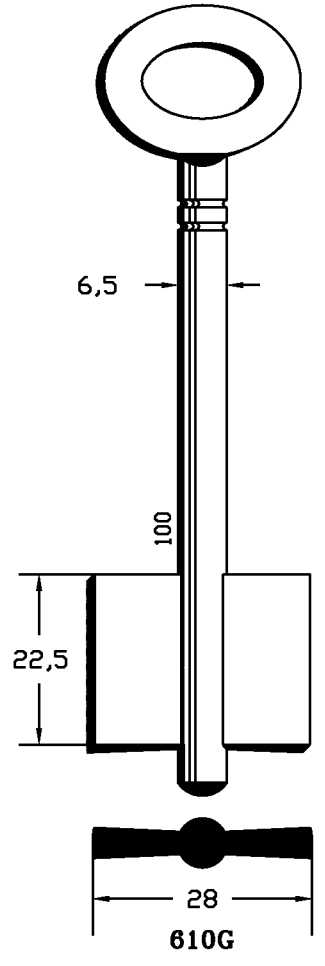
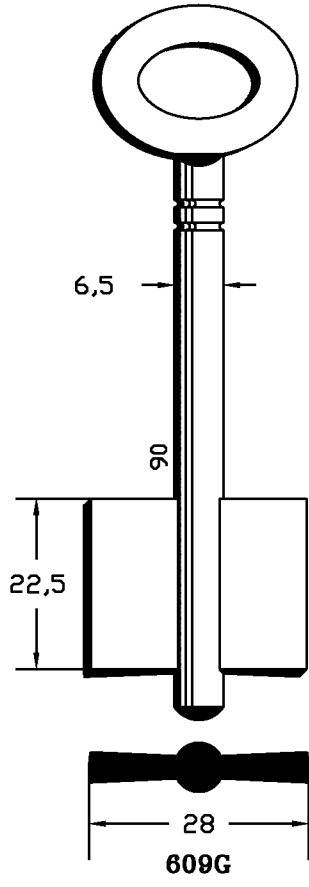
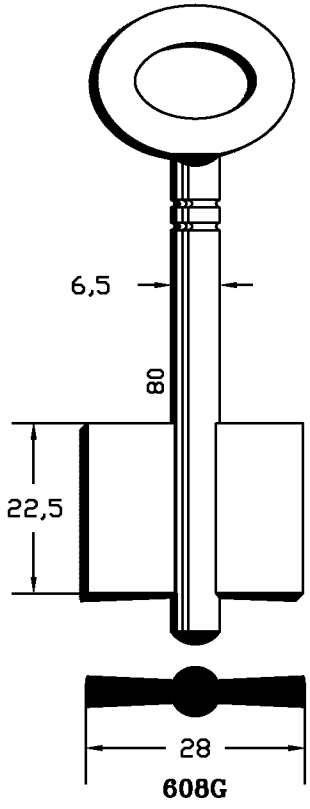

Copyright by  
Alejandro Altuna S.A.  
2005

**JMA**

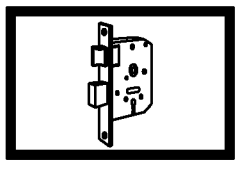

**226**

ATENCION:Concerniente a las marcas y denominaciones comerciales ver nota en indice.ATTENTION:Concerning the marks and commercial denominations see note in index.  
ATTENTION:Concernant les marques et denominations commerciales voir la note dans l'index.ACHTUNG:Beziehen auf die marke und handelsname sehen sie die notiz im index.

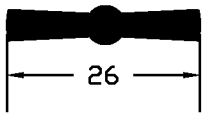
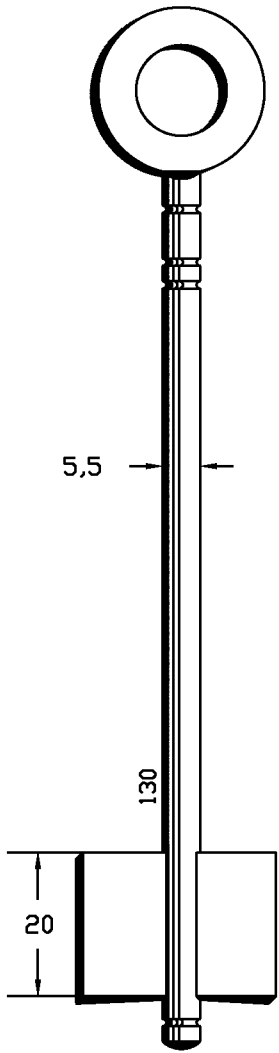

**614G**

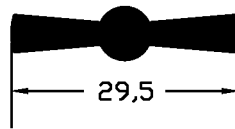
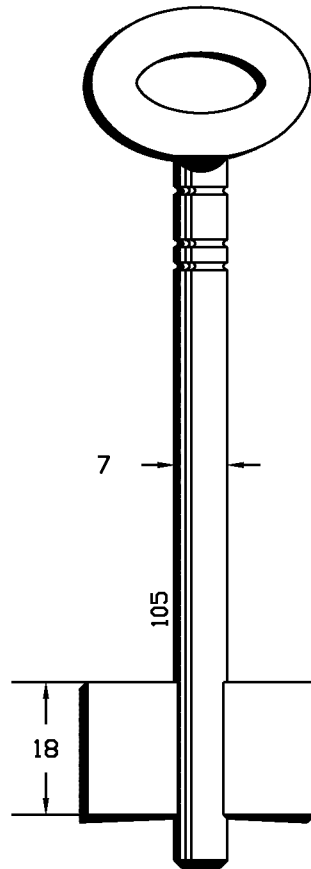

**615G**

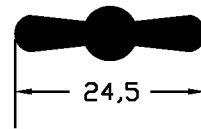
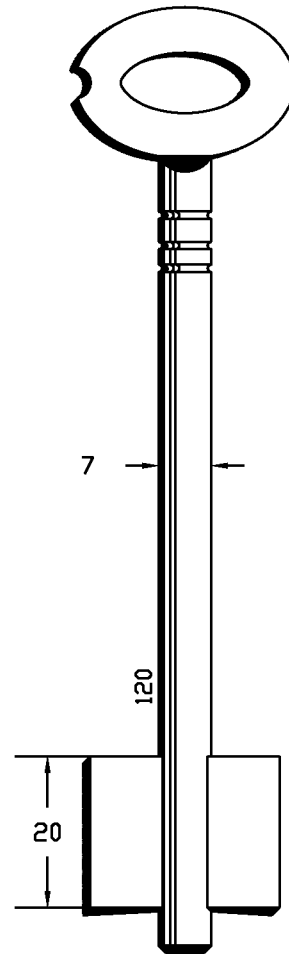

**616G**

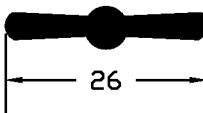
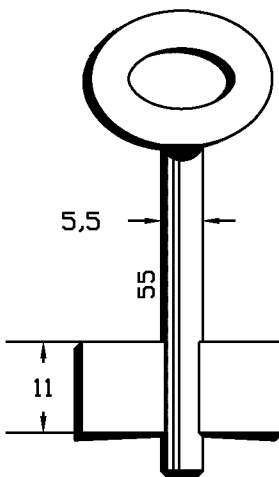

**618G**

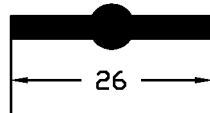
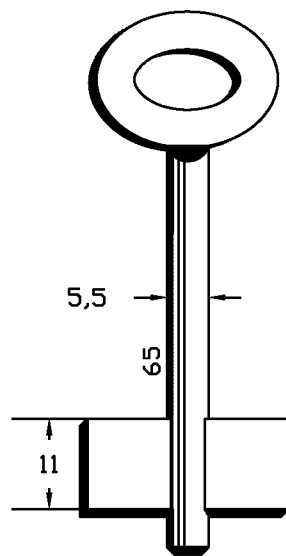

**619G**

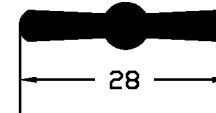
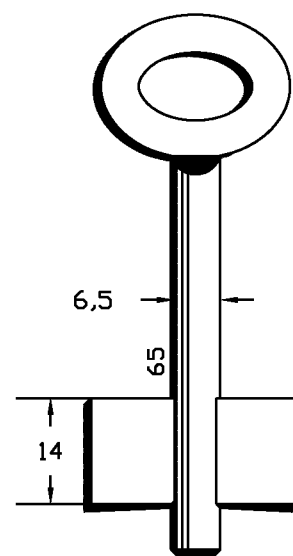

**620G**

Copyright by  
Alejandro Altuna S.A.  
2005

**JMA**

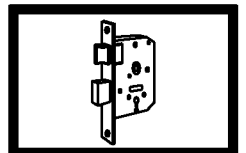

**227**

**PARA-FOR:**

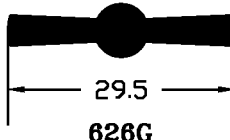
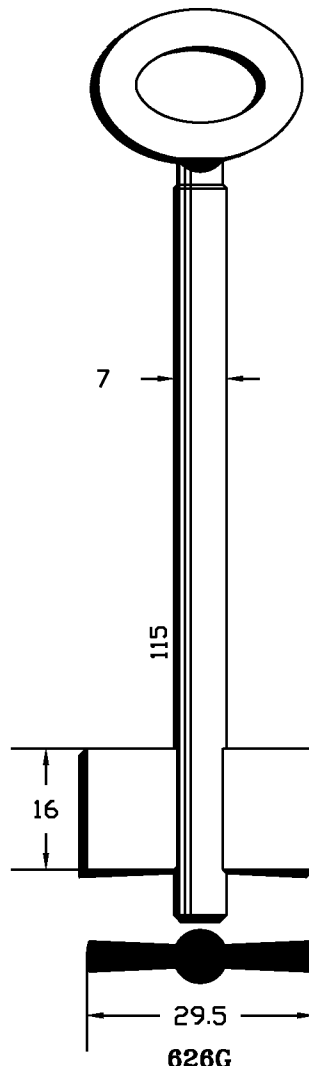
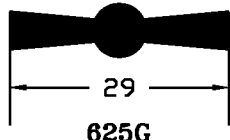
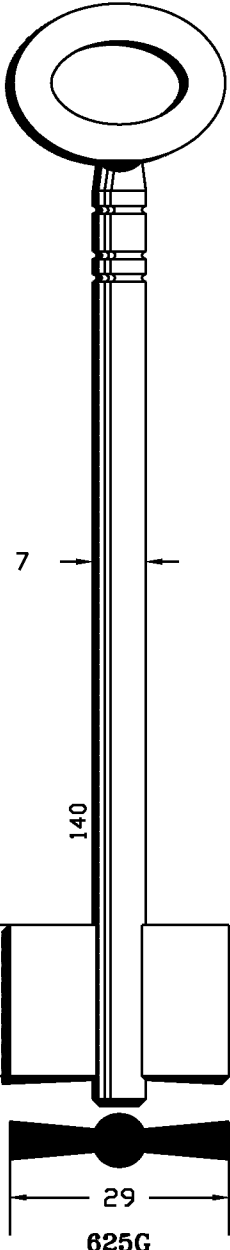
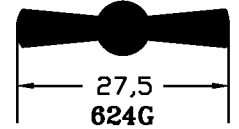
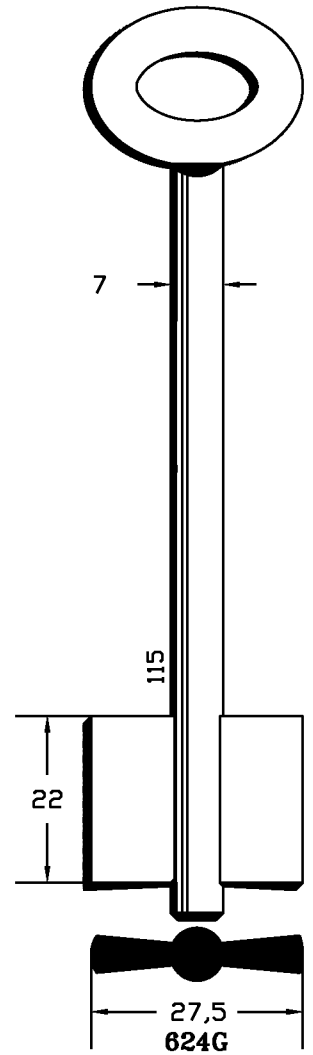
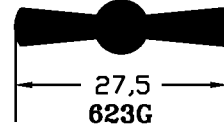
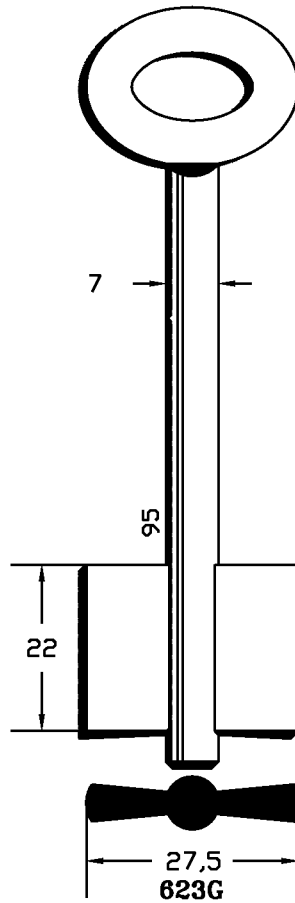
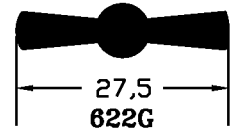
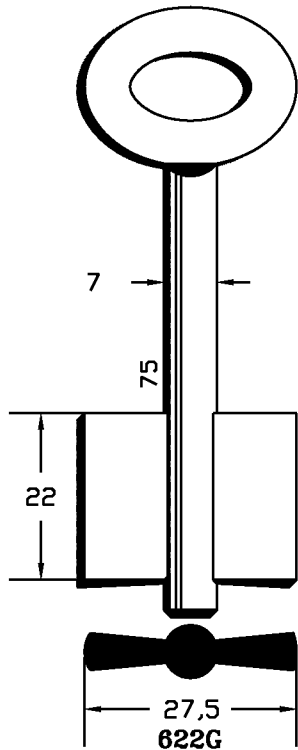

Copyright by  
Alejandro Altuna S.A.  
2005

**JMA**

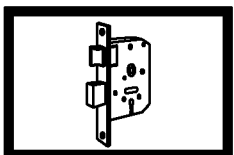

**228**

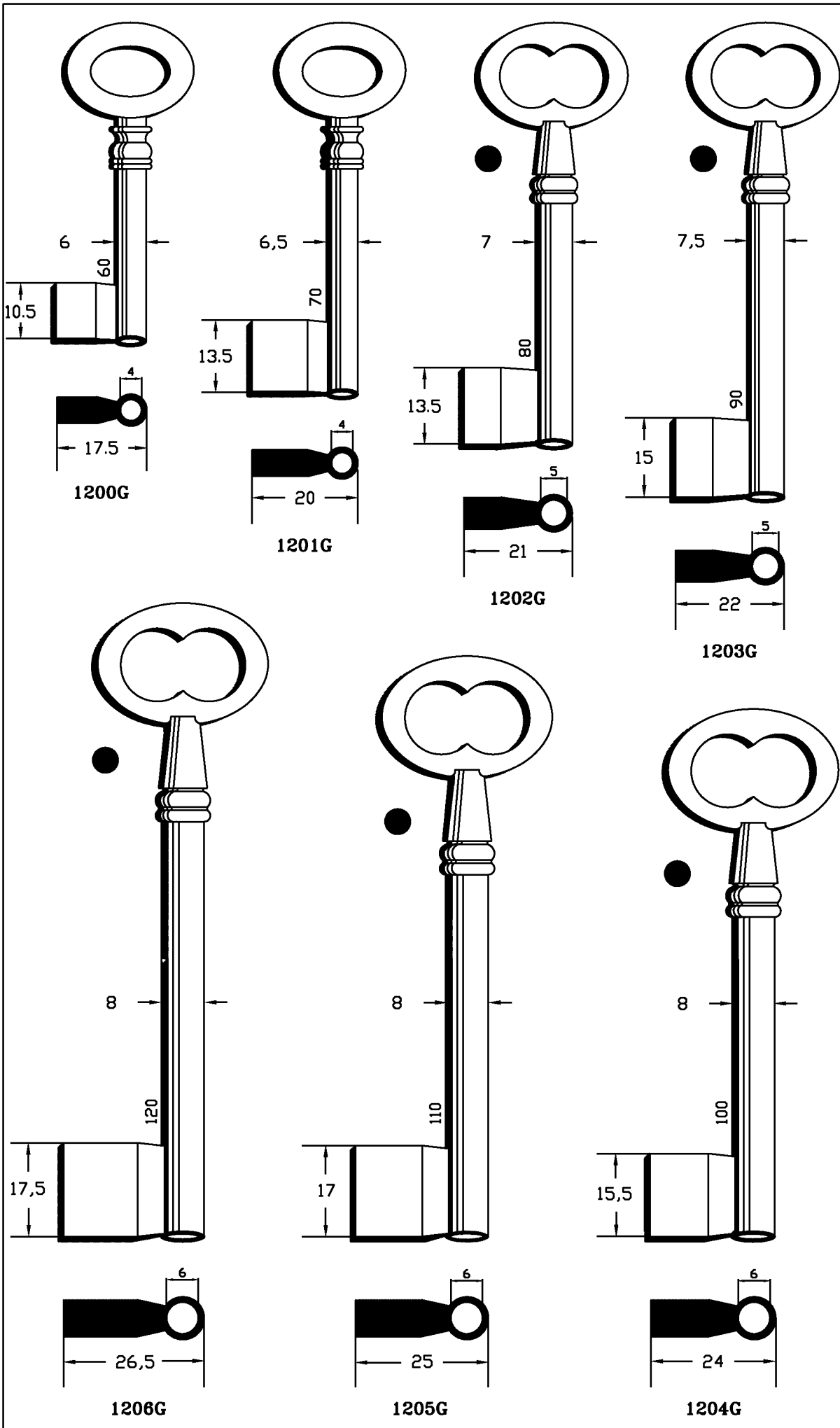

Copyright by  
Alejandro Altuna S.A.  
2005

**JMA**

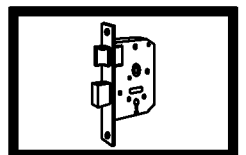

**229**

**PARA-FOR:**

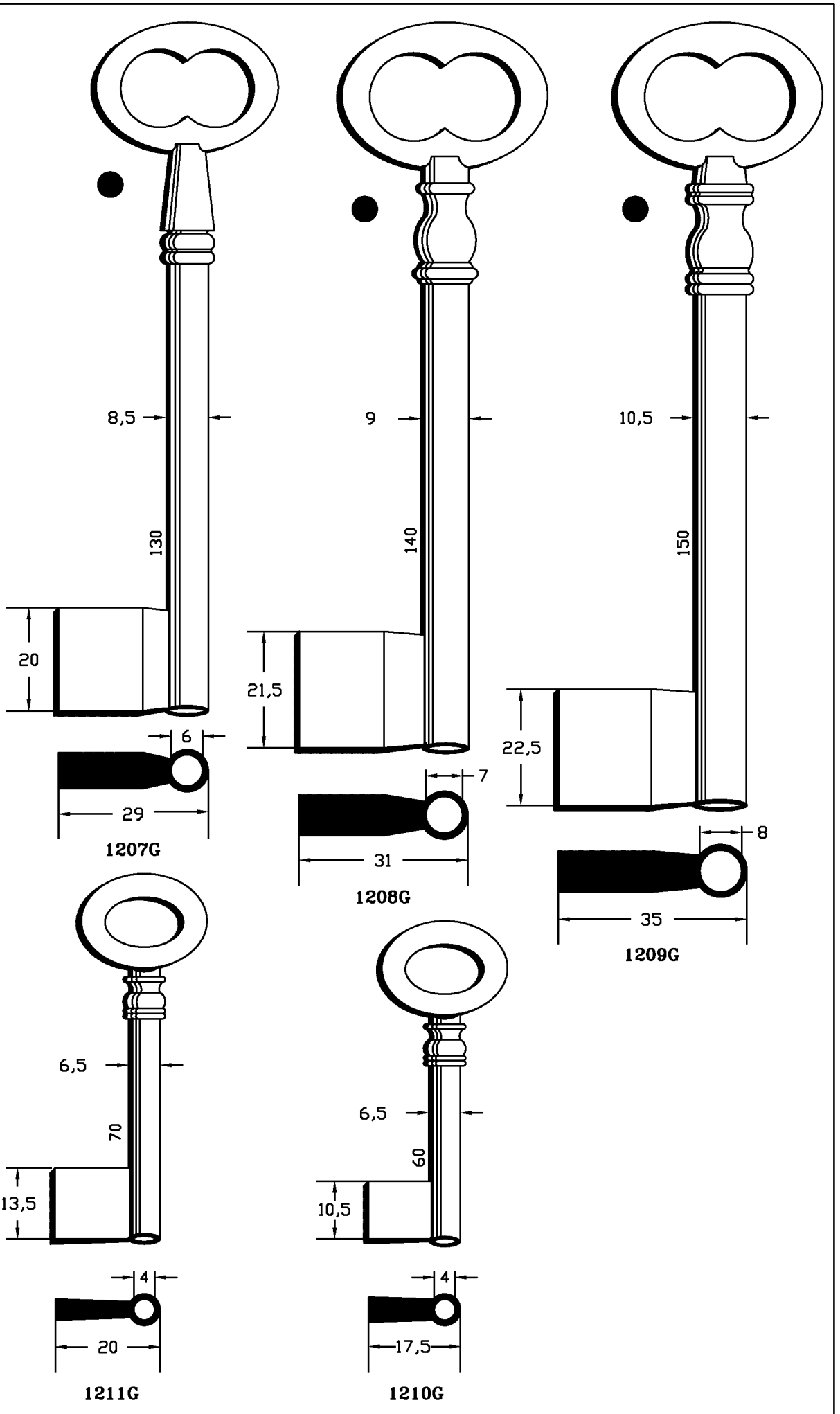

Copyright by  
Alejandro Altuna S.A.  
2005

**JMA**

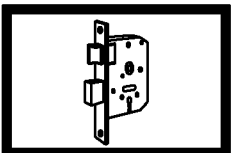

**230**

ATENCION:Concerniente a las marcas y denominaciones comerciales ver nota en indice.ATTENTION:Concerning the marks and commercial denominations see note in index.  
ATTENTION:Concernant les marques et denominations commerciales voir la note dans l'index.ACHTUNG:Beziehen auf die marke und handelsname sehen sie die notiz im index.

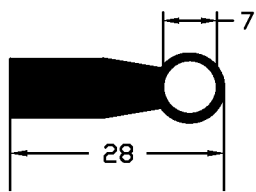
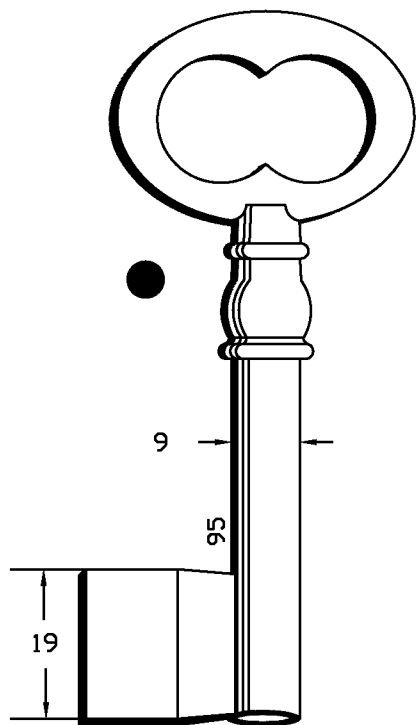

1212G

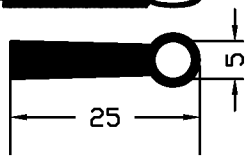
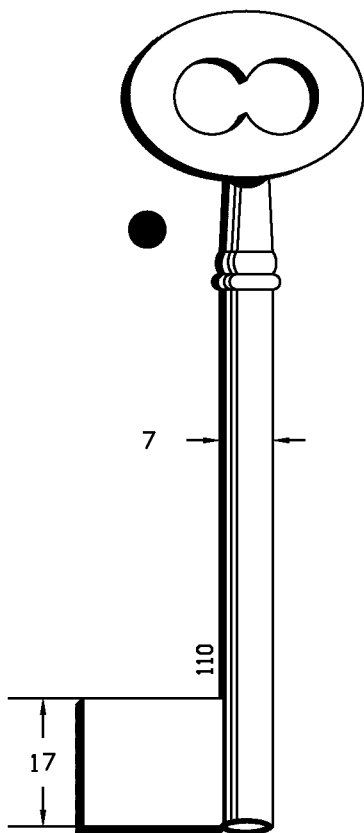

1213G

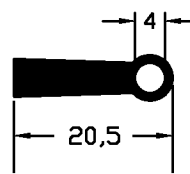
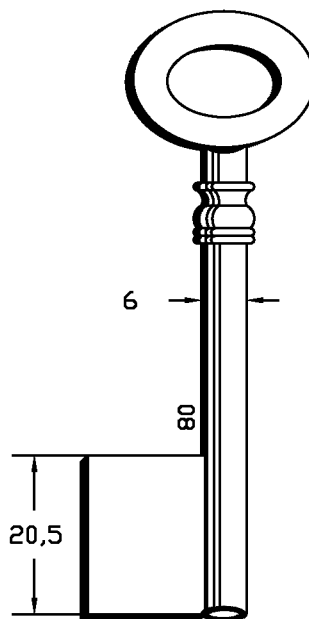

1214G

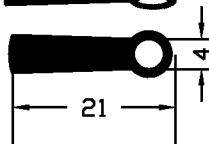
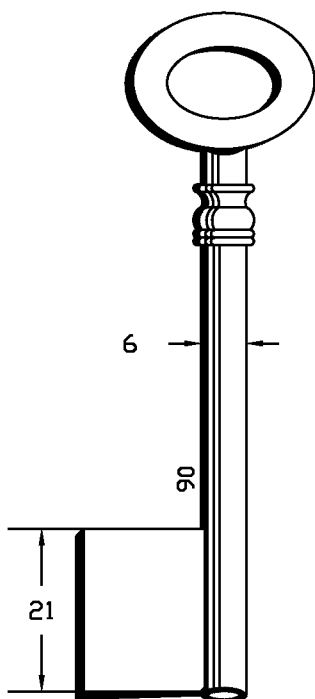

1215G

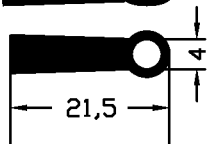
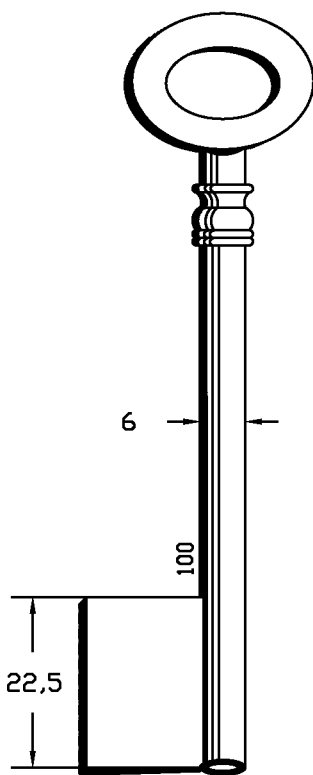

1216G

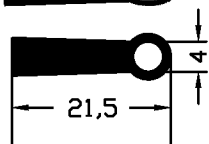
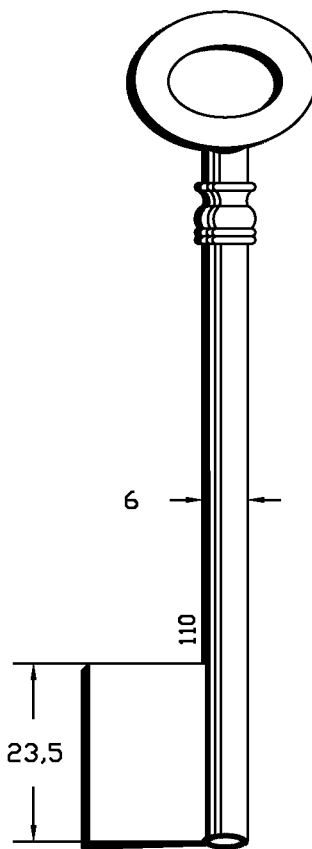

1217G

Copyright by  
Alejandro Altuna S.A.  
2005

**JMA**

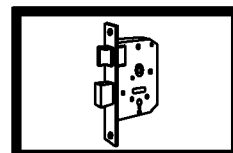

**231**

**PARA-FOR:**

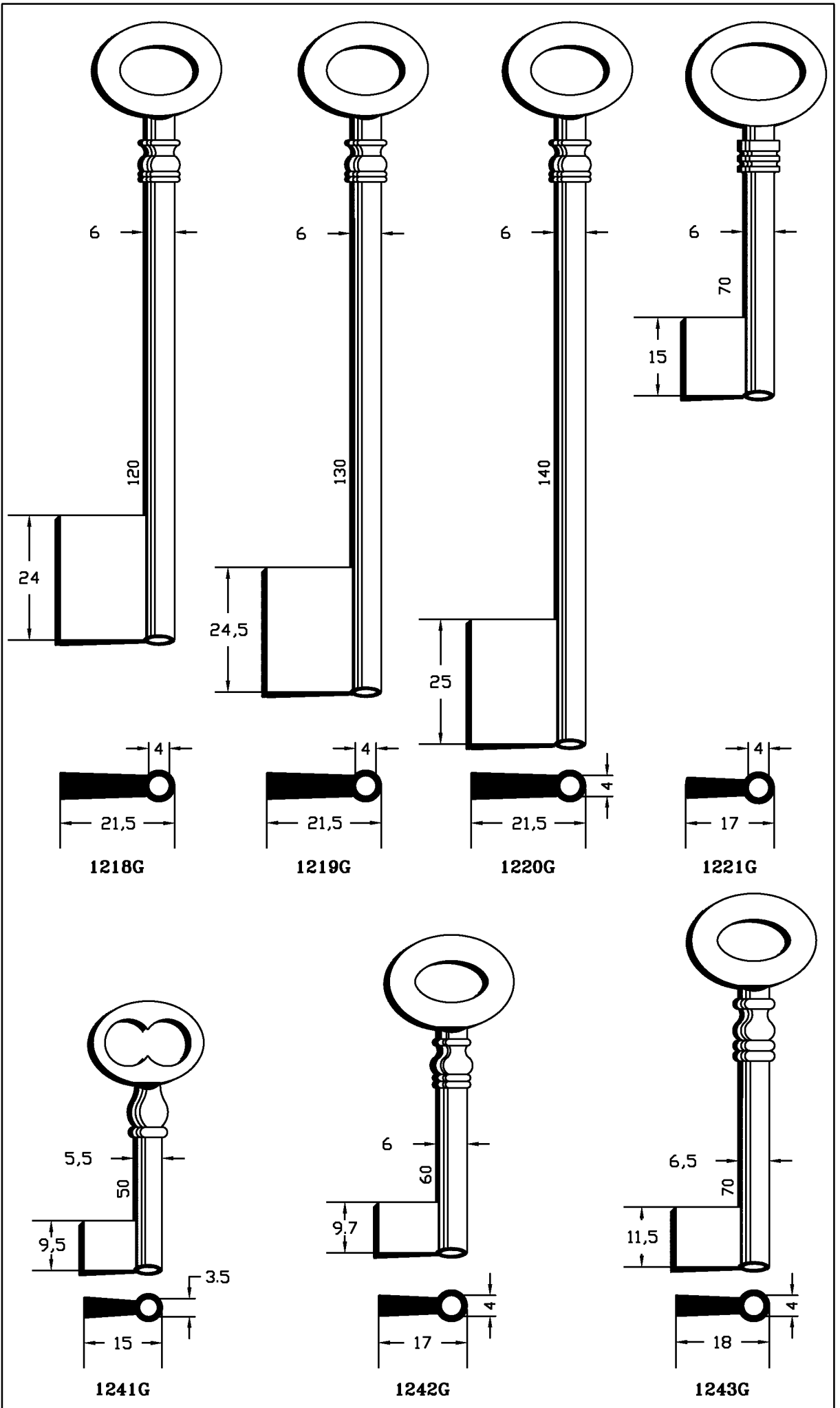

1218G

1219G

1220G

1221G

1241G

1242G

1243G

Copyright by  
Alejandro Altuna S.A.  
2005

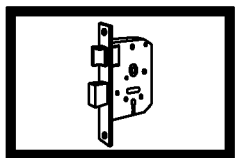

**232**

ATENCION:Concerniente a las marcas y denominaciones comerciales ver nota en indice.ATTENTION:Concerning the marks and commercial denominations see note in index. ATTENTION:Concernant les marques et denominations commerciales voir la note dans l'index.ACHTUNG:Beziehen auf die marke und handelsname sehen sie die notiz im index.

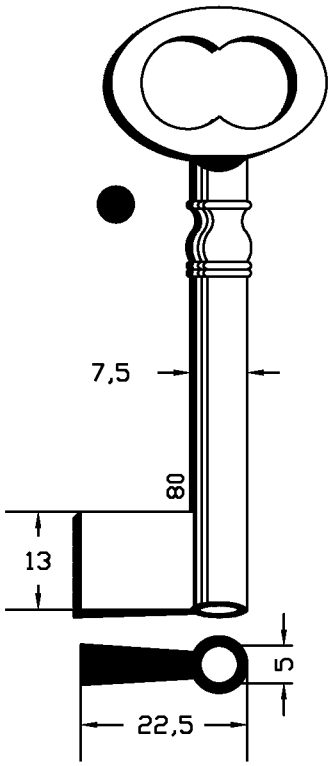

1244G

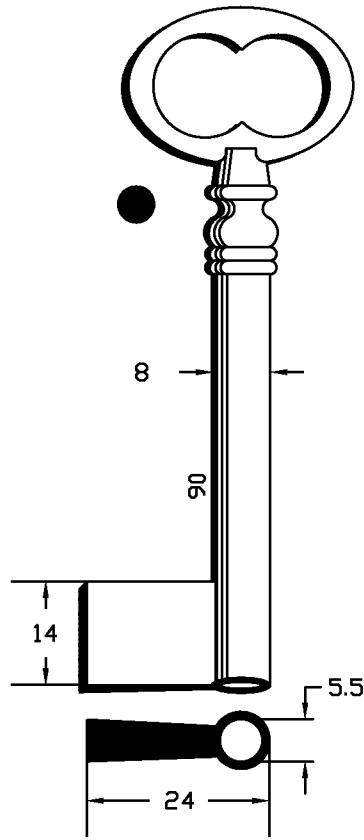

1245G

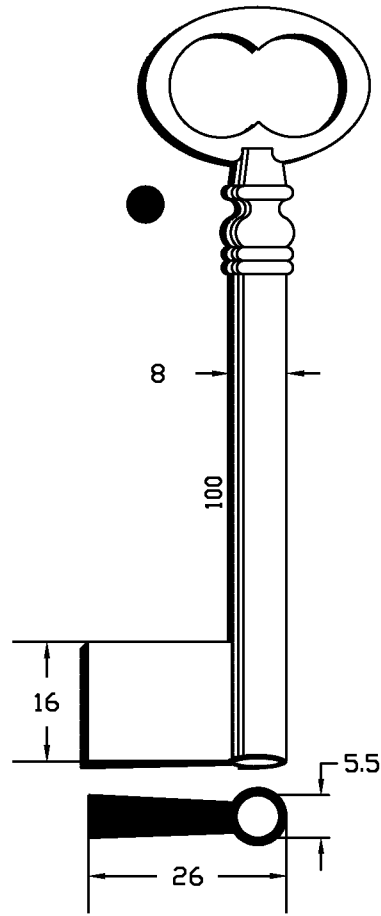

1246G

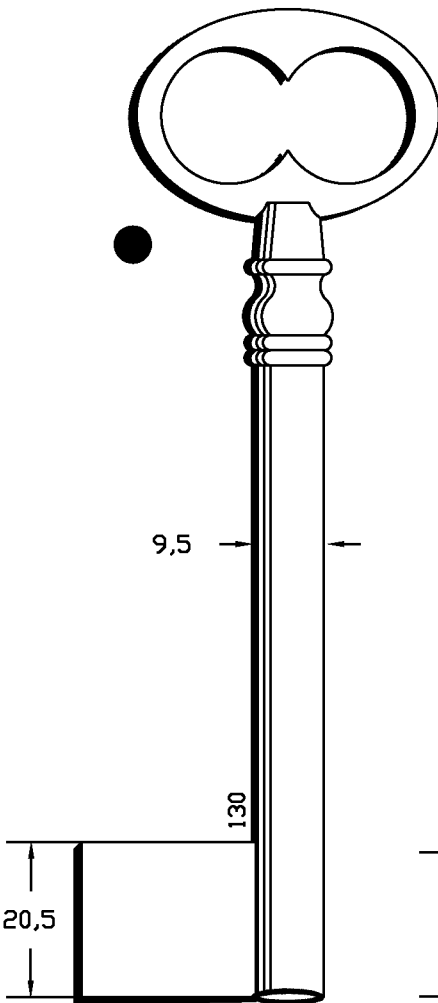

1249G

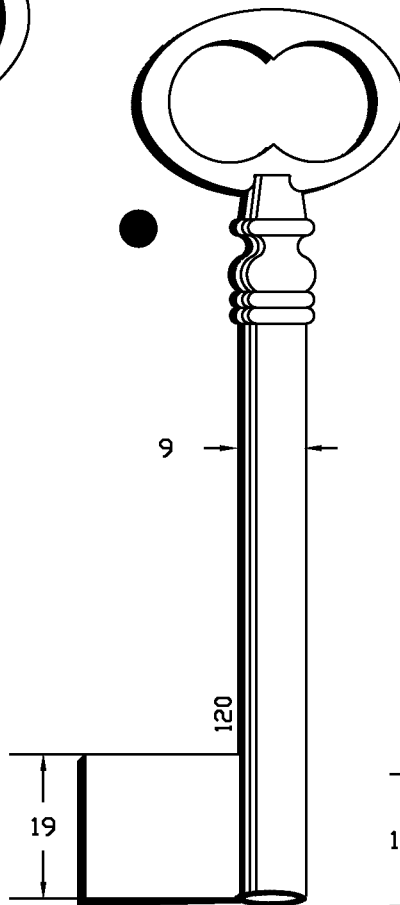

1248G

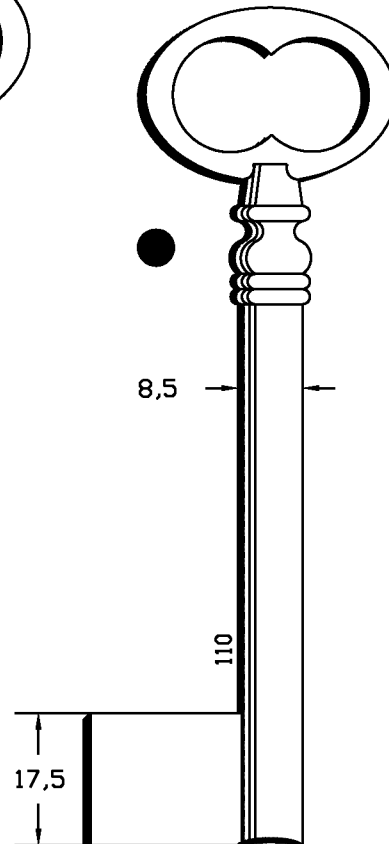

1247G

Copyright by  
Alejandro Altuna S.A.  
2005

**JMA**

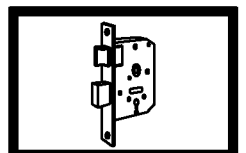

**233**

**PARA-FOR:**

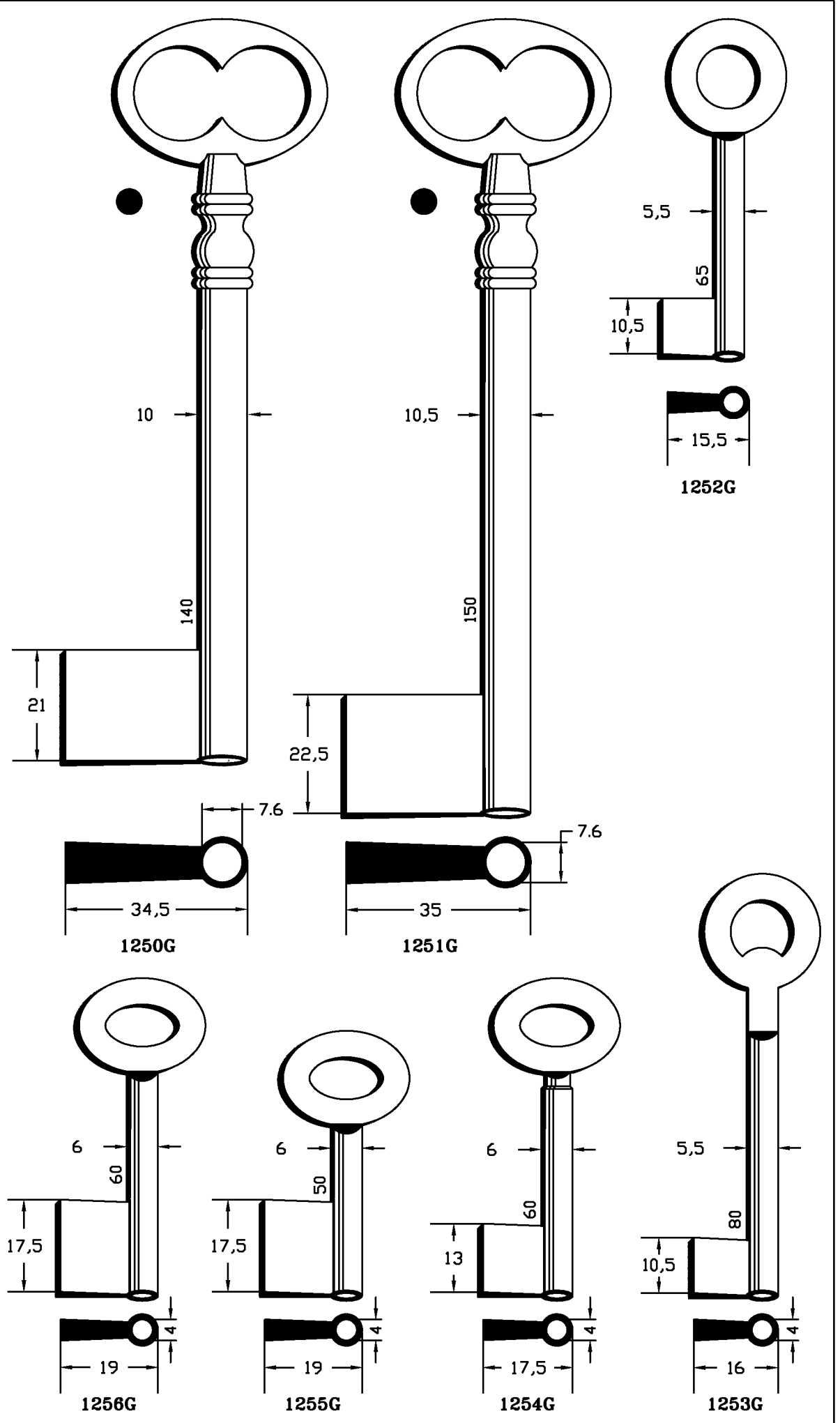

Copyright by  
Alejandro Altuna S.A.  
2005

**JMA**

**234**

ATENCION:Concerniente a las marcas y denominaciones comerciales ver nota en indice.ATTENTION:Concerning the marks and commercial denominations see note in index. ATTENTION:Concernant les marques et denominations commerciales voir la note dans l'index.ACHTUNG:Beziehen auf die marke und handelsname sehen sie die notiz im index.

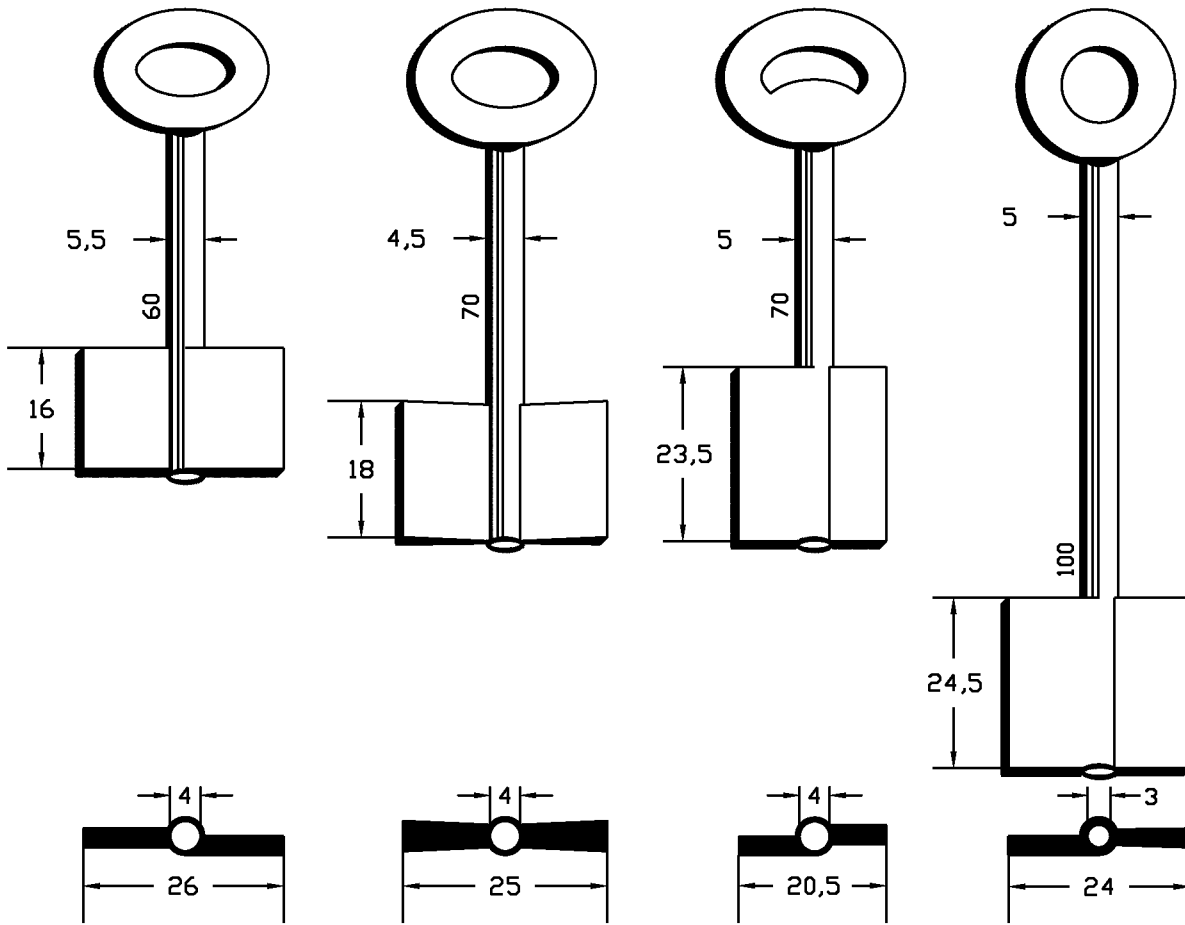

1600G

1601G

1602G

1603G

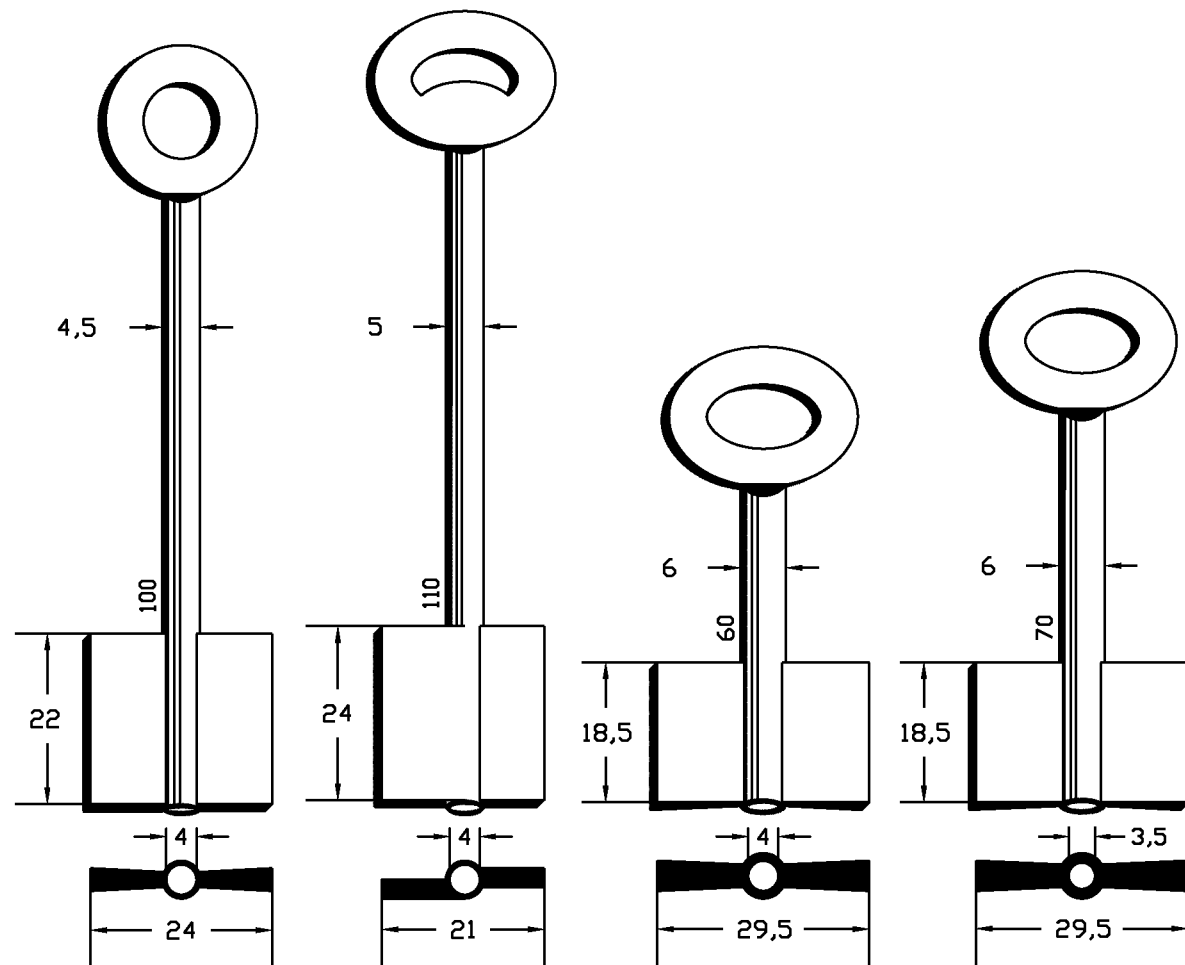

1604G

1605G

1606G

1607G

Copyright by  
Alejandro Altuna S.A.  
2005

**JMA**

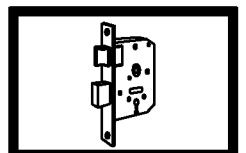

**235**

**PARA-FOR:**

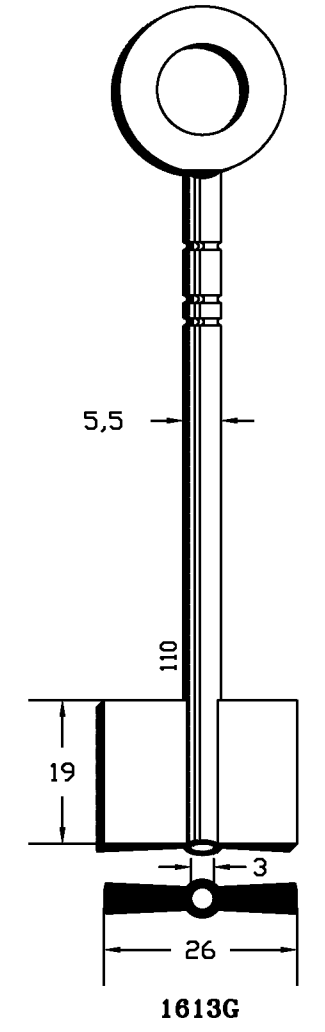
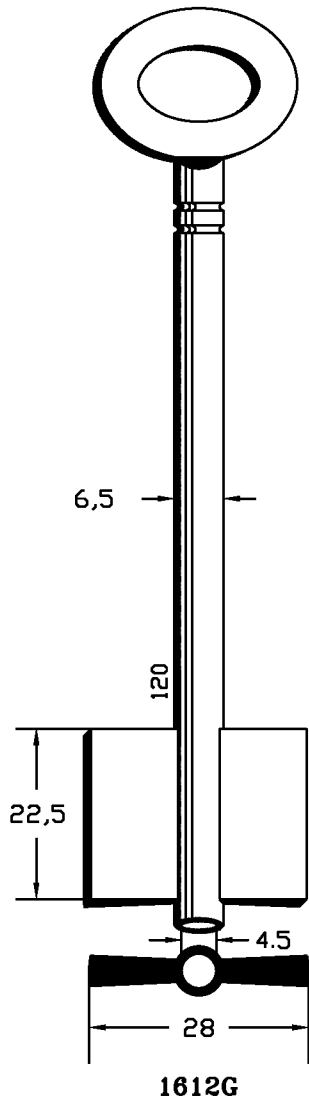
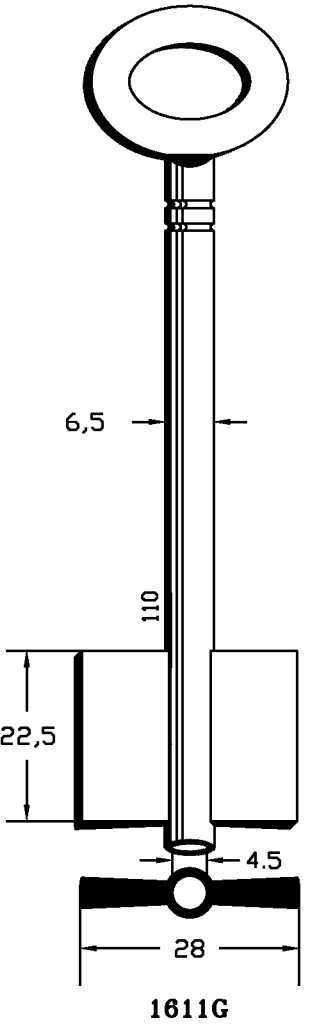
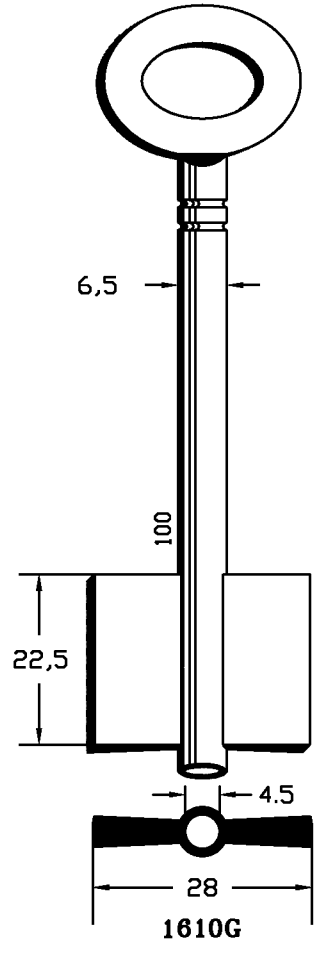
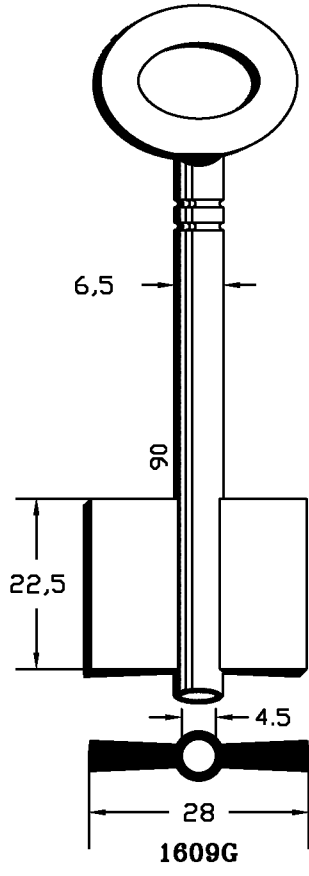
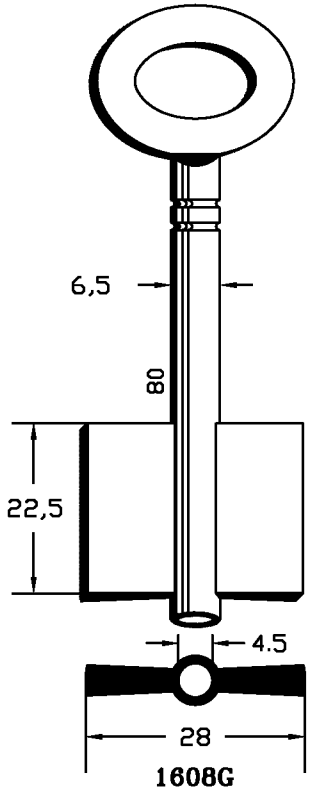

Copyright by  
Alejandro Altuna S.A.  
2005

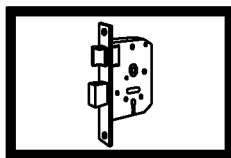

**236**

ATENCION:Concernlente a las marcas y denominaciones comereales ver nota en indice.ATTENTION:Concerning the marks and commercial denominations see note in index. ATTENTION:Concernant les marques et denominations commerciales voir la note dans l'index.ACHTUNG:Beziehen auf die marke und handelsname sehen sie die notiz im index.

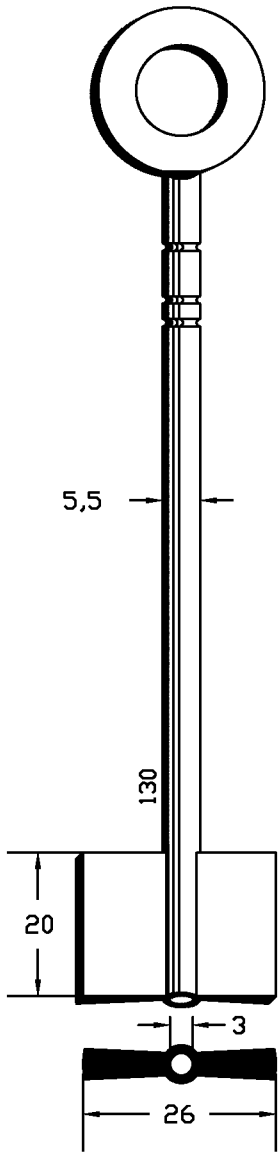

**1614G**

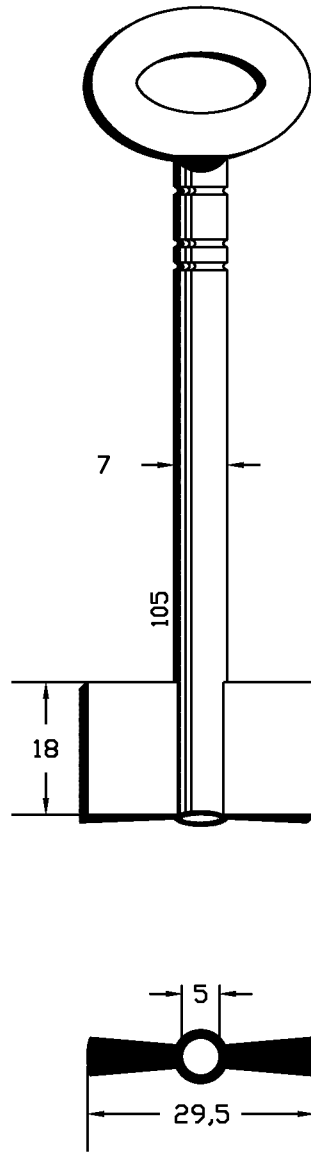

**1615G**

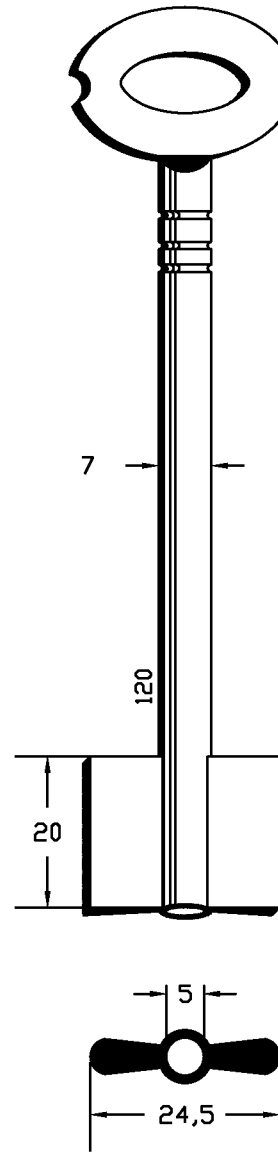

**1616G**

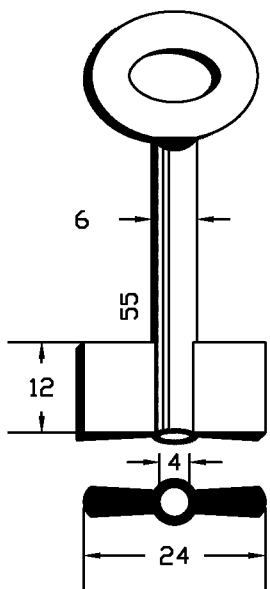

**1617G**

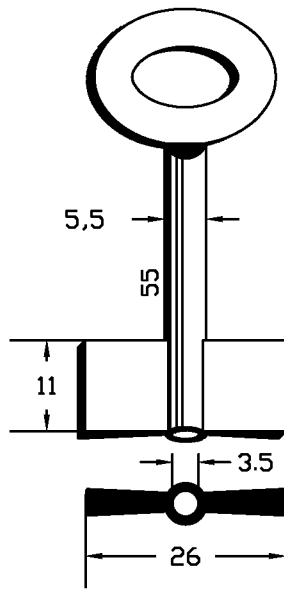

**1618G**

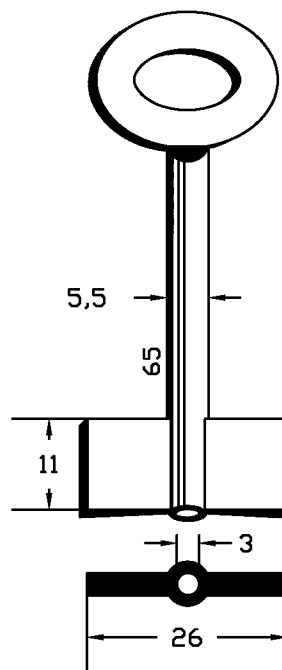

**1619G**

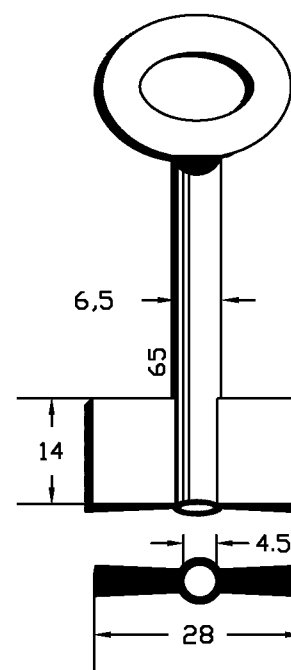

**1620G**

Copyright by  
Alejandro Altuna S.A.  
2005

**JMA**

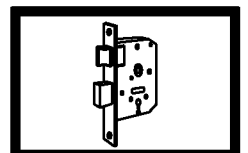

**237**

**PARA-FOR:**

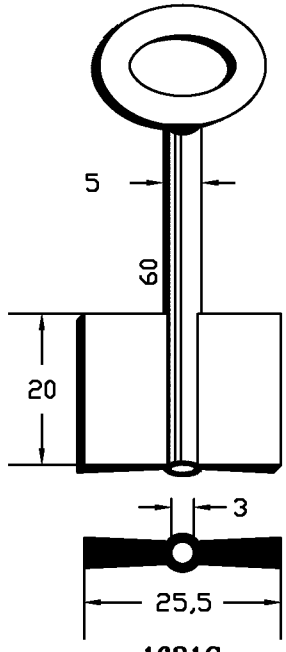

**1621G**

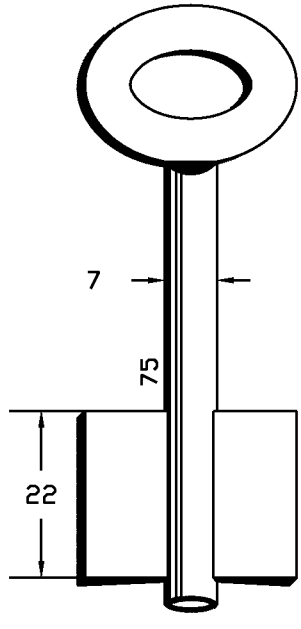

**1622G**

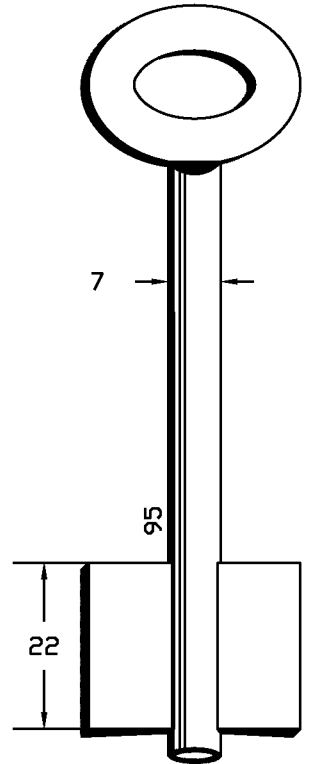

**1623G**

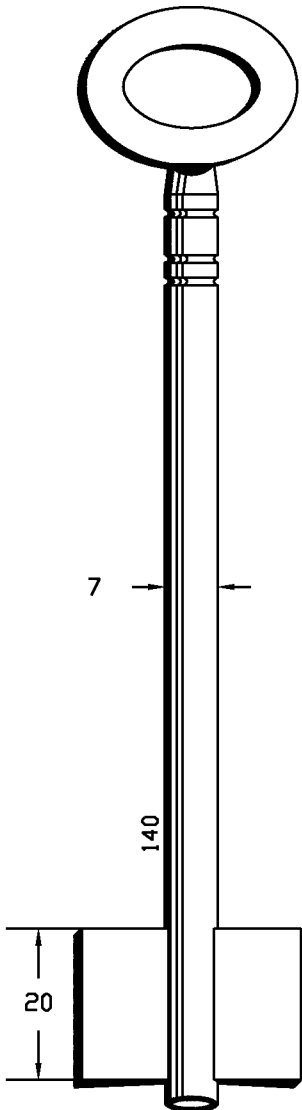

**1625G**

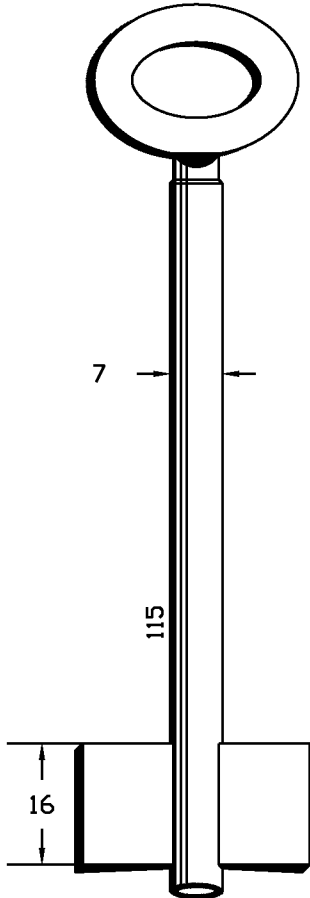

**1626G**

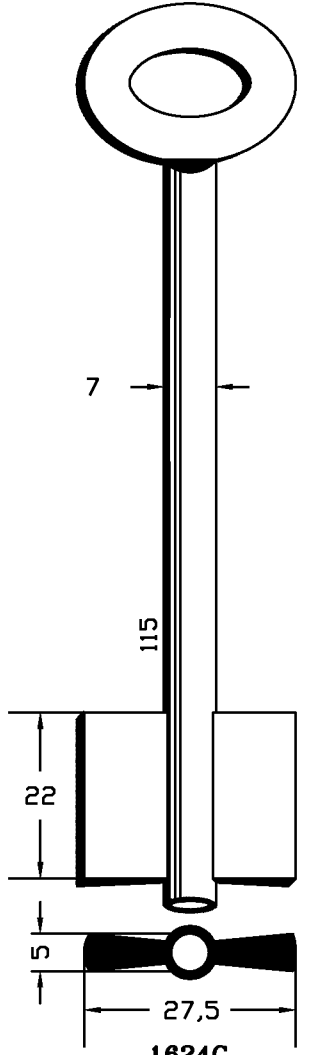

**1624G**

Copyright by Alejandro Altuna S.A. 2005

**JMA**

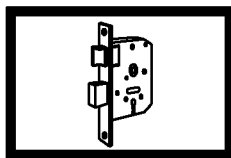

**238**

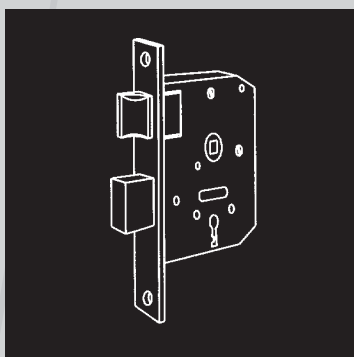

# **JMA**

**LLAVES DE GORJA LATÓN**

**LETOIZKO GORJA GILTZAK**

**BRASS BIT KEYS**

**CLÉS À GORGES EN LAITON**

**CHUBBSCHLÜSSEL AUS MESSING**

**CHIAVI A MAPPA DI OTTONE**

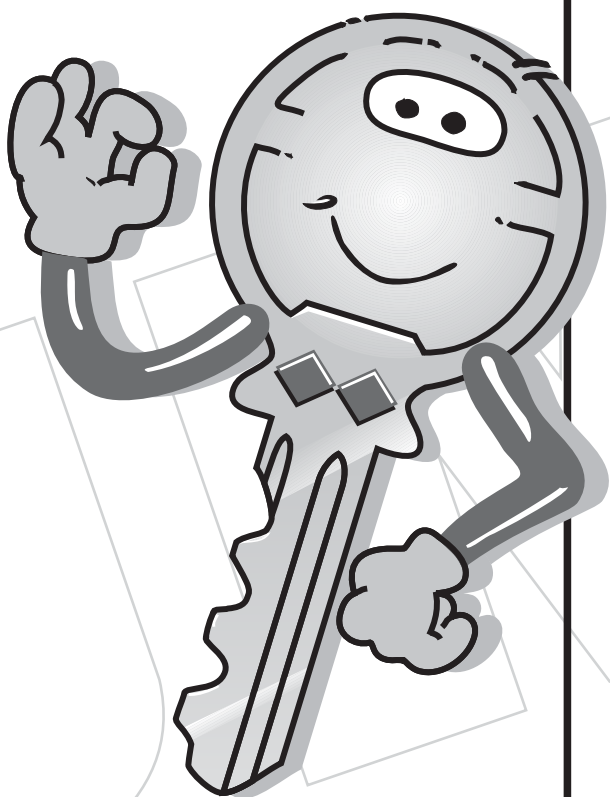

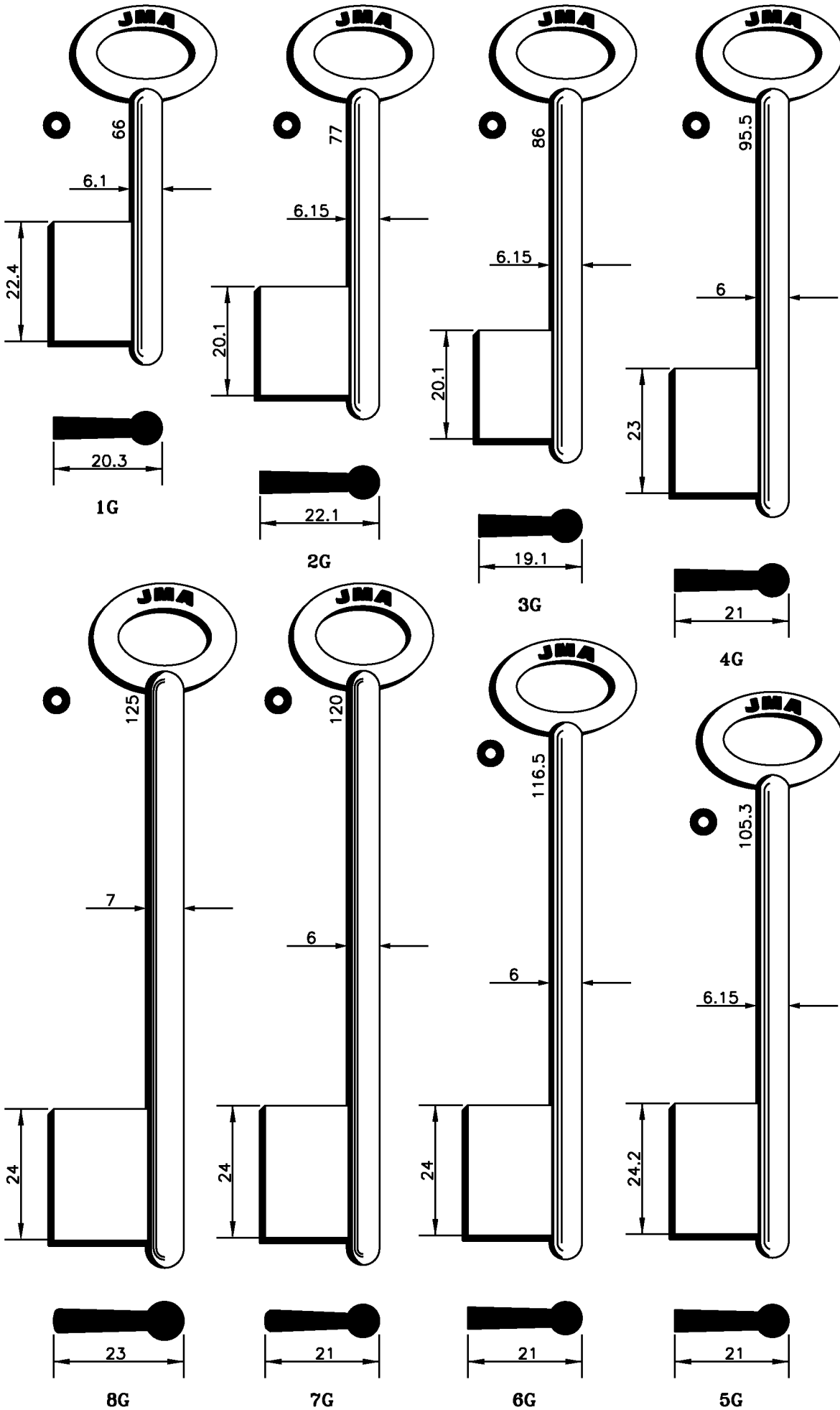

Copyright by  
Alejandro Altuna S.A.  
2005

**JMA**

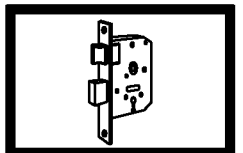

**241**

**PARA-FOR:**

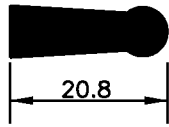
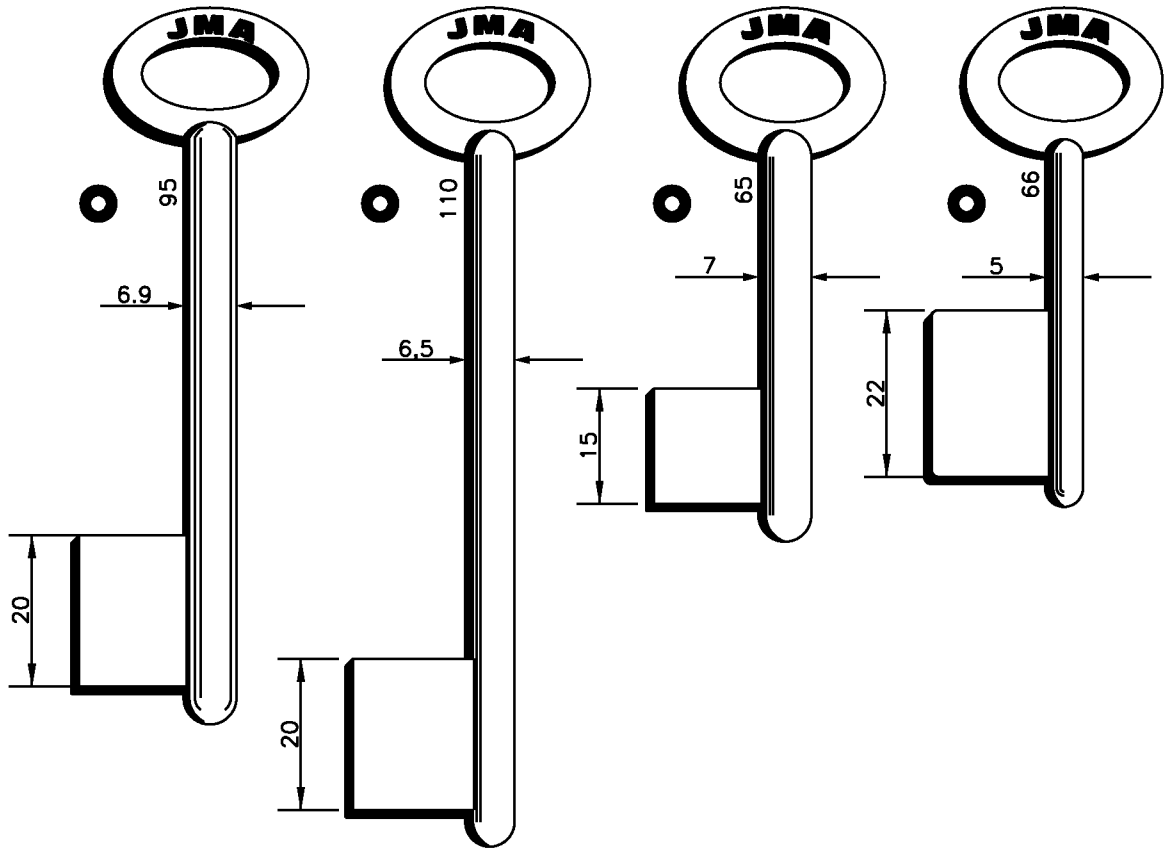

11G

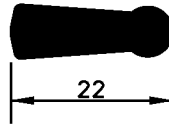

12G

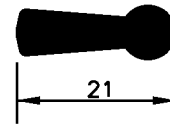

13G

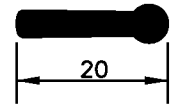

14G

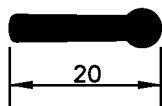
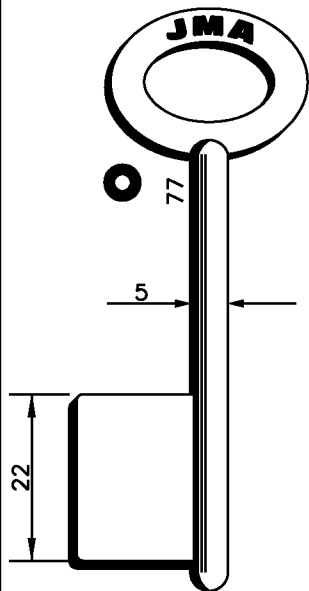

15G

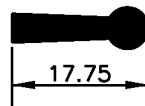
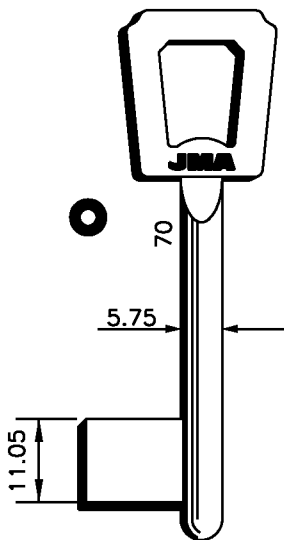

16G

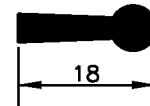
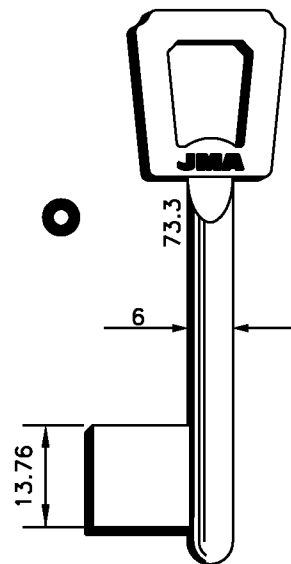

17G

Copyright by  
Alejandro Altuna S.A.  
2005

**JMA**

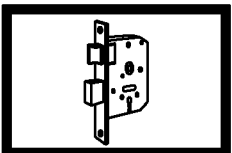

**242**

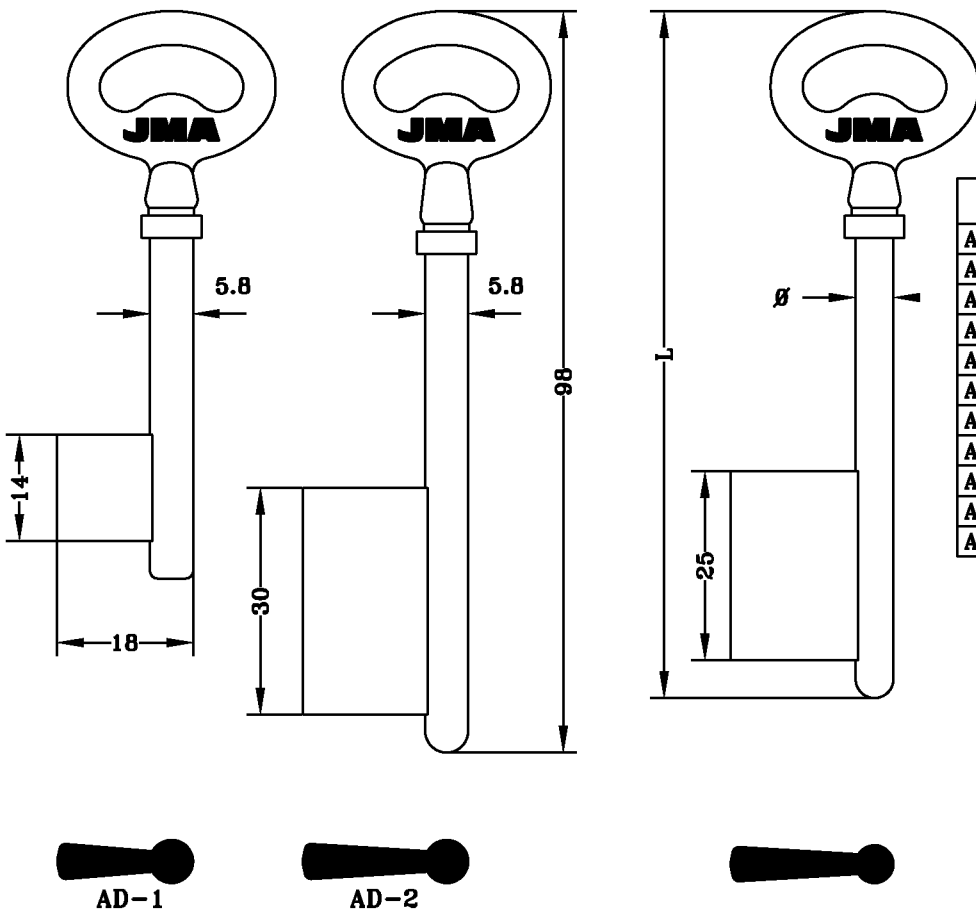
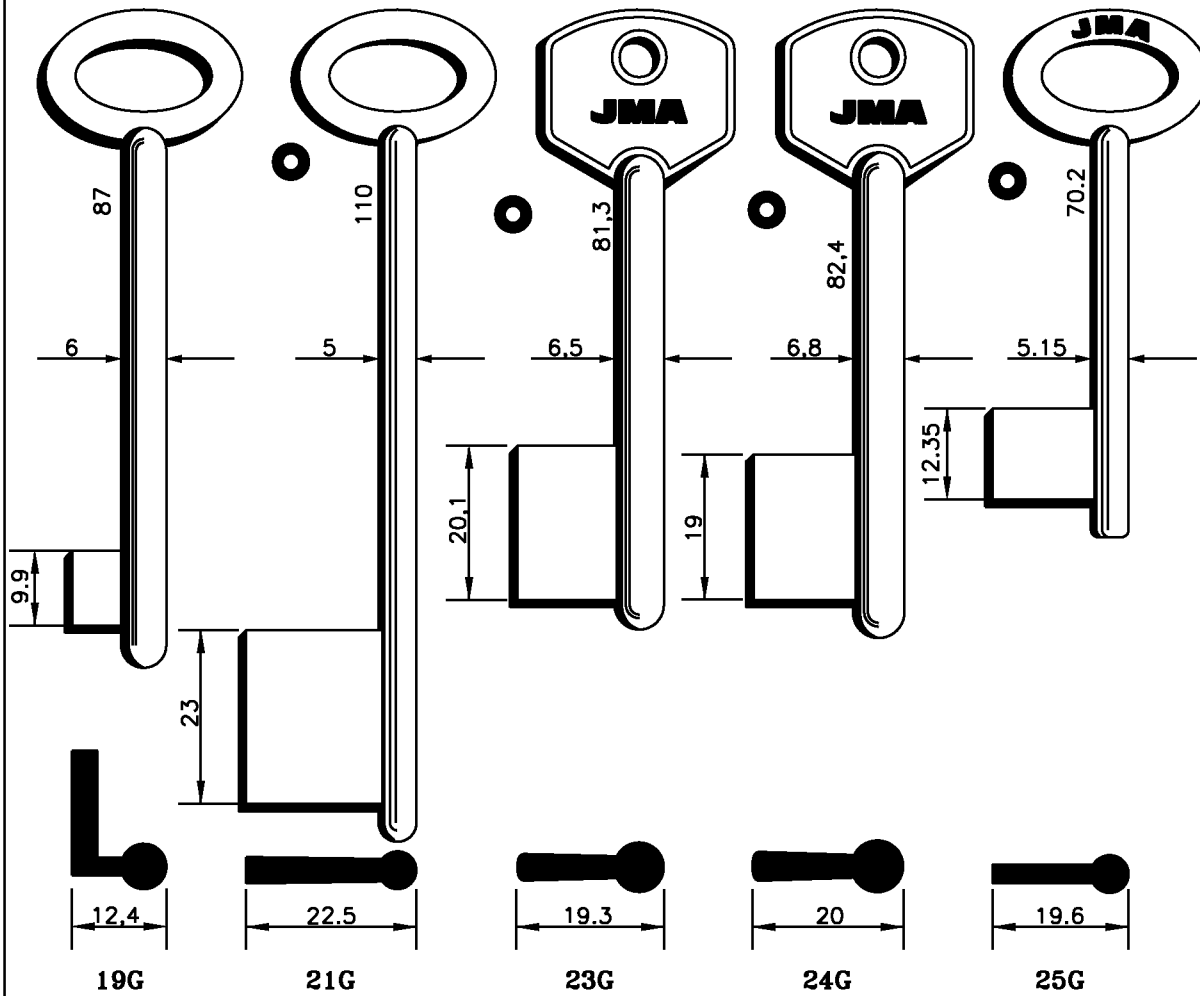

REF.	L	Ø
AD-3	90	5
AD-4	95	5
AD-5	100	5
AD-6	80	5,5
AD-7	95	5,5
AD-8	100	5,5
AD-9	80	5,8
AD-10	90	6
AD-11	95	6
AD-12	100	6
AD-13	100	6,5

Copyright by  
Alejandro Altuna S.A.  
2005

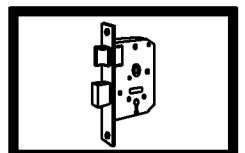

**PARA-FOR:**

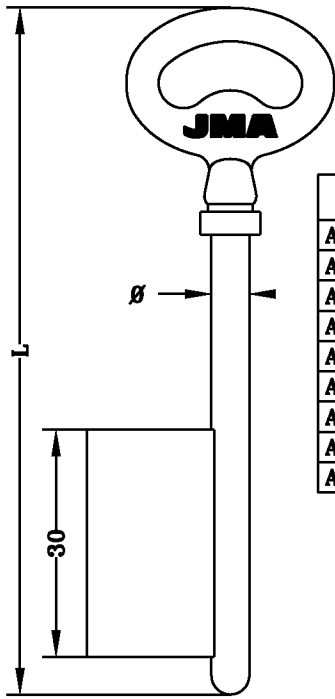

REF.	L	Ø
AD-16	110	5
AD-18	95	5,5
AD-19	110	5,5
AD-21	95	5,8
AD-23	110	6
AD-26	95	6,5
AD-27	110	6,5
AD-28	120	6,5
AD-29	100	6,5

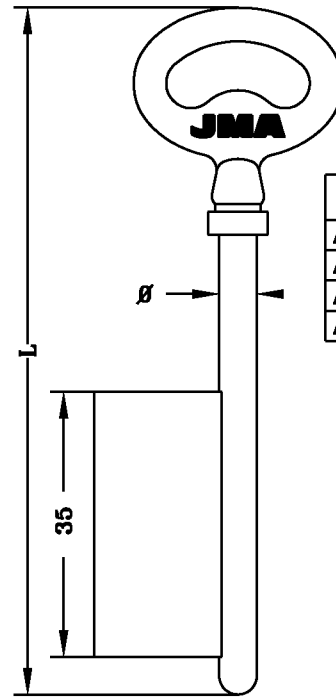

REF.	L	Ø
AD-17	120	5
AD-20	120	5,5
AD-24	120	6
AD-25	140	6

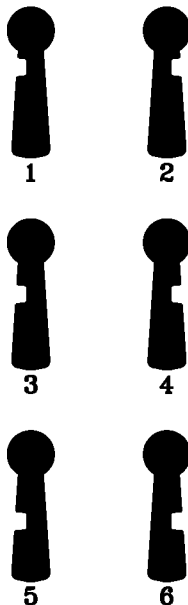
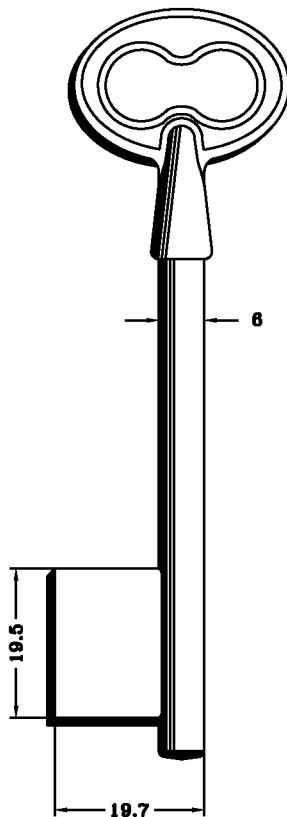

AD-44-....

Copyright by  
Alejandro Altuna S.A.  
2005

**JMA**

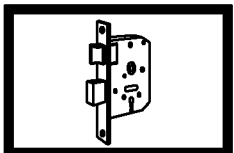

**244**

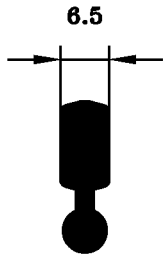

ADPLE-1

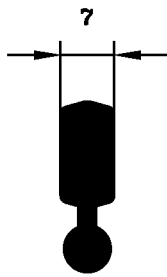
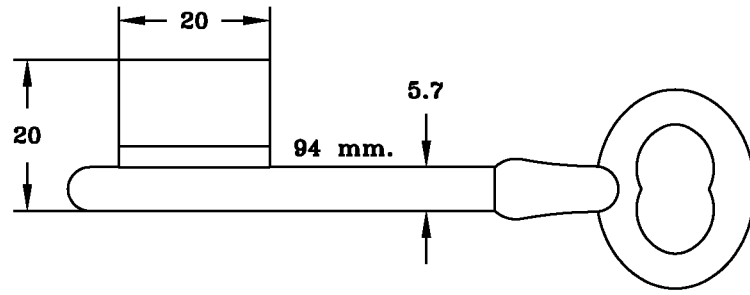

ADPLE-2

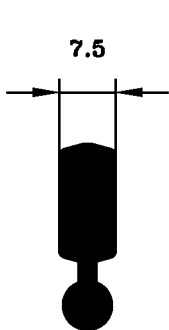
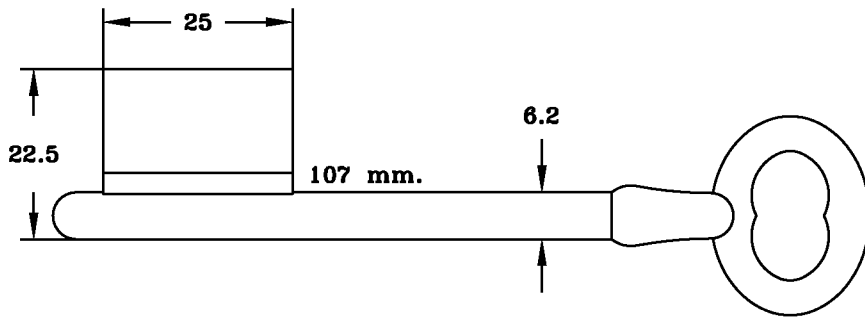

ADPLE-3

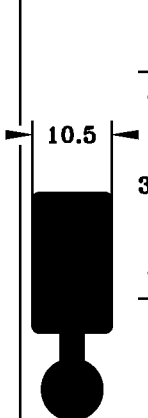
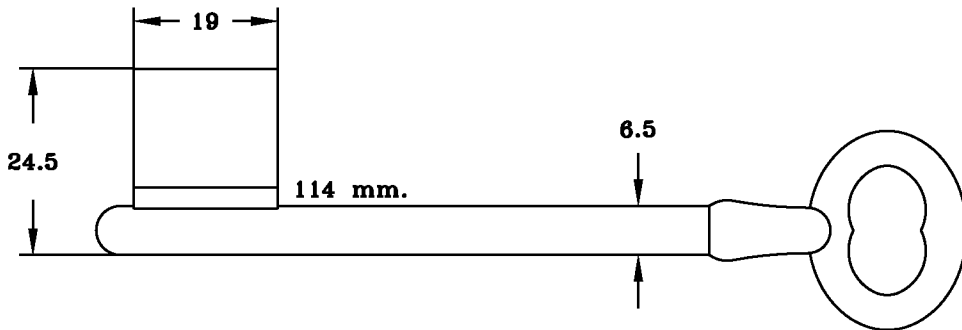

ADPLE-4

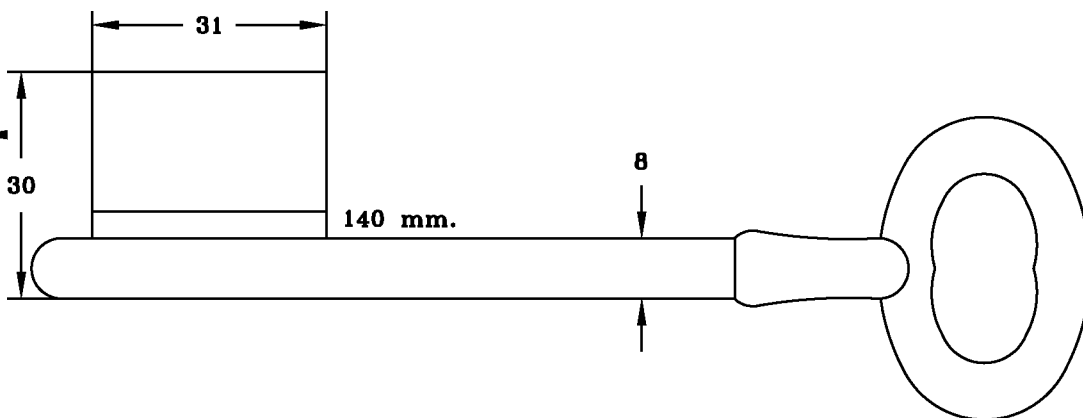

Copyright by  
Alejandro Alfuna S.A.  
2005

**JMA**

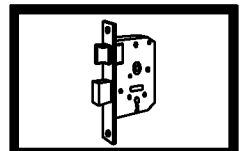

**245**

**PARA-FOR:**

126 (S)

AGA (E)

ASSA (S)

PARA:  
FOR:

126

AGA

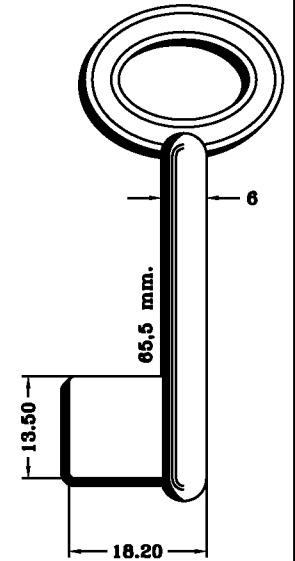
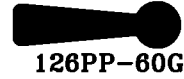
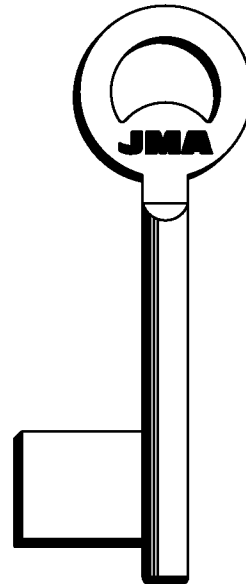
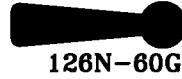
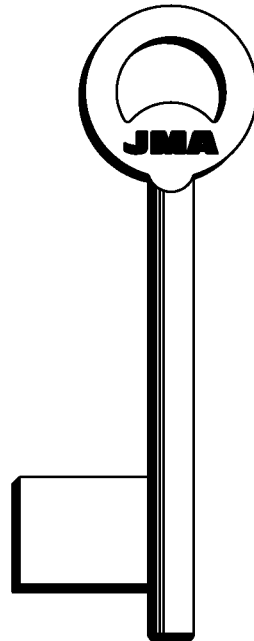
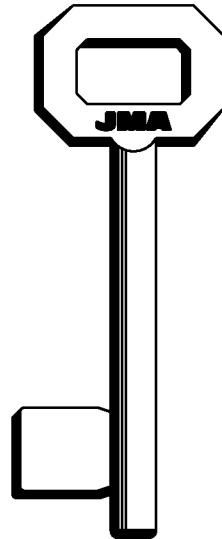

PARA:  
FOR:

ASSA

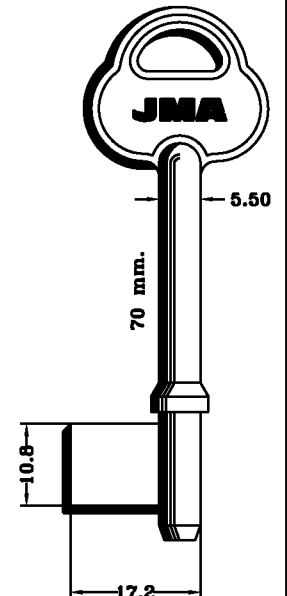
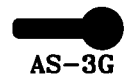
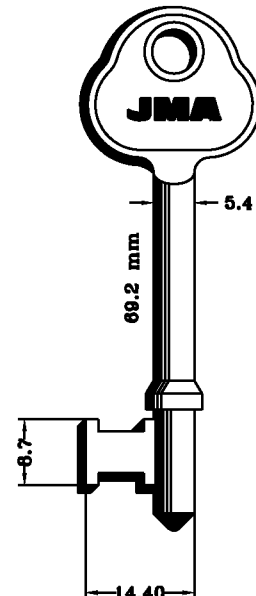
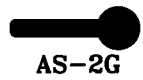
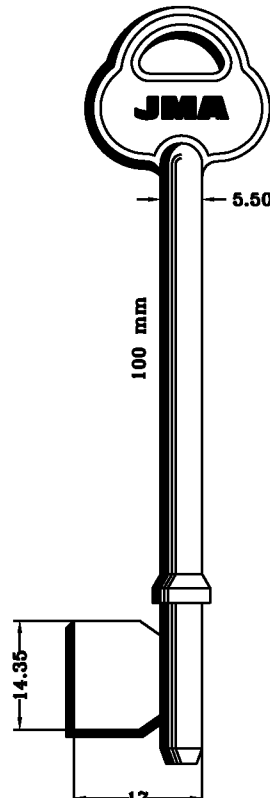
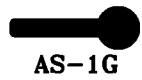
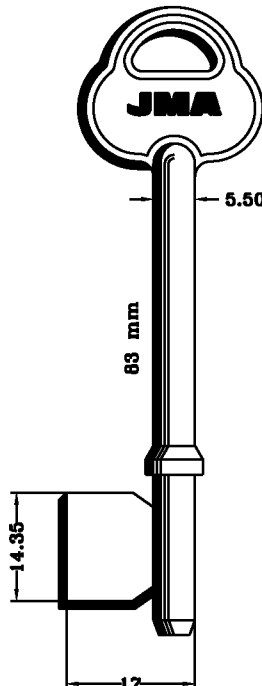

Copyright by  
Alejandro Altuna S.A.  
2005

**JMA**

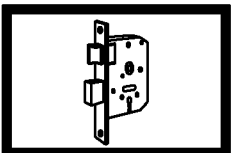

**246**

**PARA:** ASSA  
**FOR:**

AS-6G/2

**BODA**

BOD-4G

BOD-5G

**PARA-FOR:**

ASSA (S)  
BODA (SF)  
BRICARD (F)  
CHUBB (GB)

**PARA:** BRICARD  
**FOR:**

BRI-6L...

**CHUBB**

CHU-1G

CHU-2G

Copyright by  
Alejandro Altuna S.A.  
2005

**JMA**

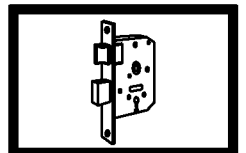

**247**

**PARA-FOR:**

**DEBEAURAIN (F)**

**ELZETT (H)**

**ERA (GB)**

**ESA (E)**

**FAS-YALE (S)**

**PARA-FOR: DEBEAURAIN**

**ELZETT**

**ERA**

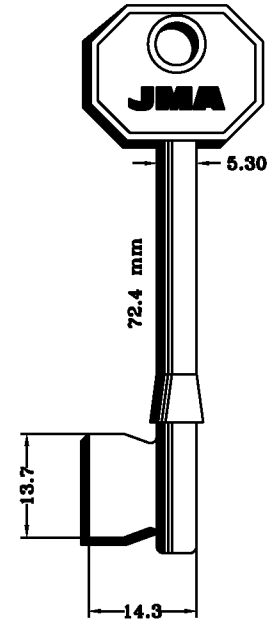
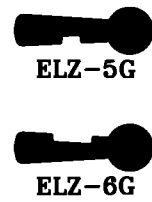
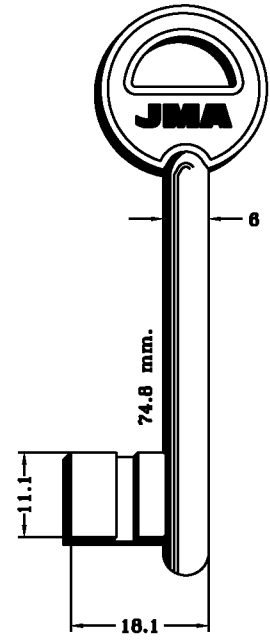
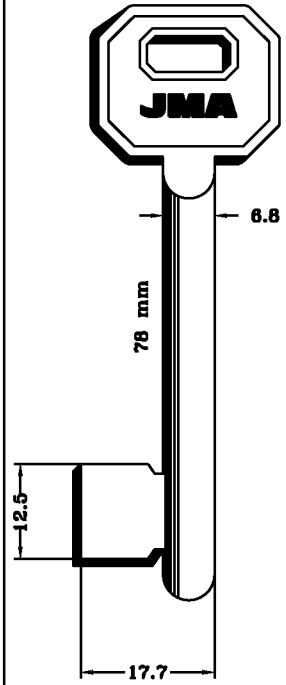
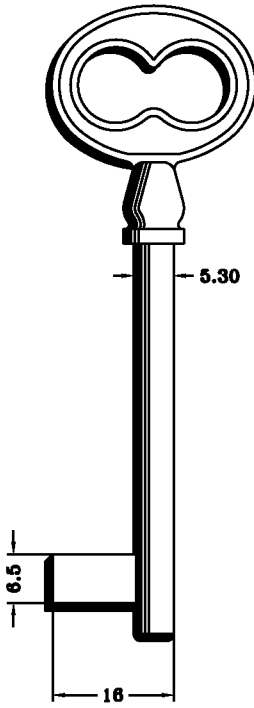

**PARA-FOR: ERA**

**ESA**

**FAS-YALE**

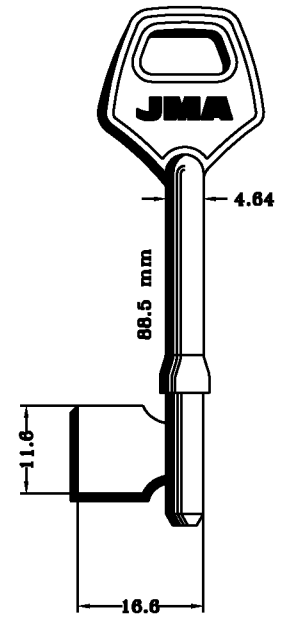
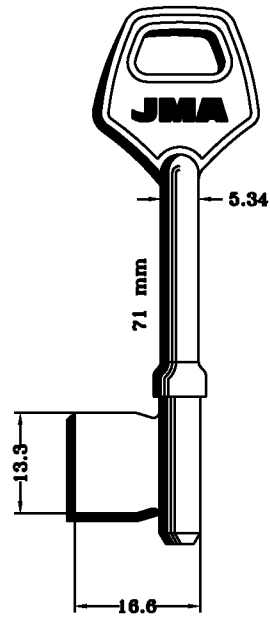
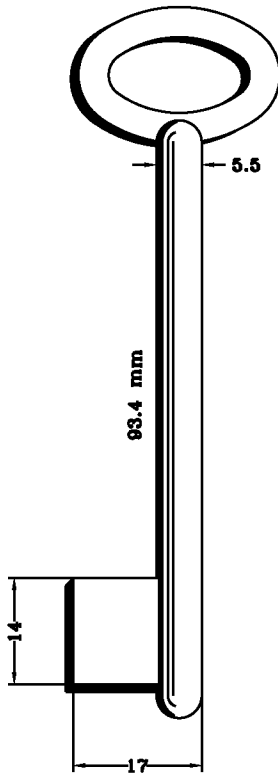
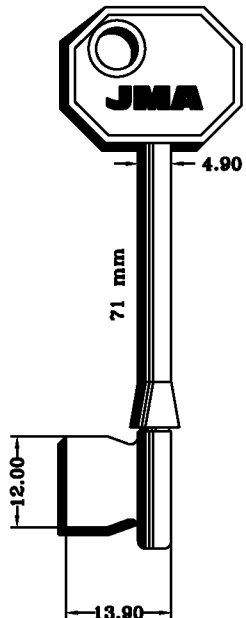

Copyright by Alejandro Altuna S.A. 2005

**JMA**

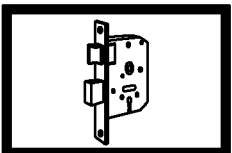

**248**

PARA:  
FOR:

FAS-YALE

PARA-FOR:

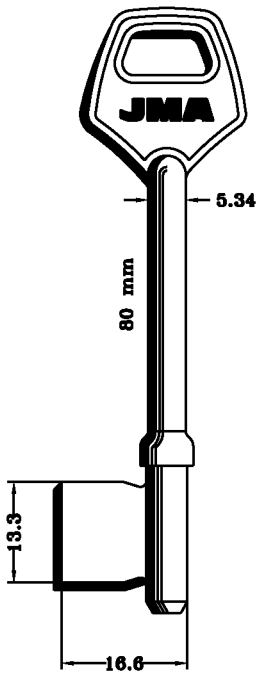

FA-3G

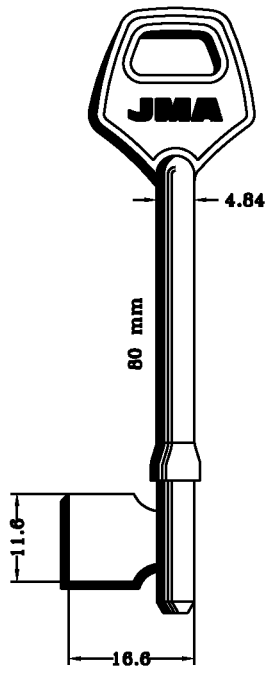

FA-4G

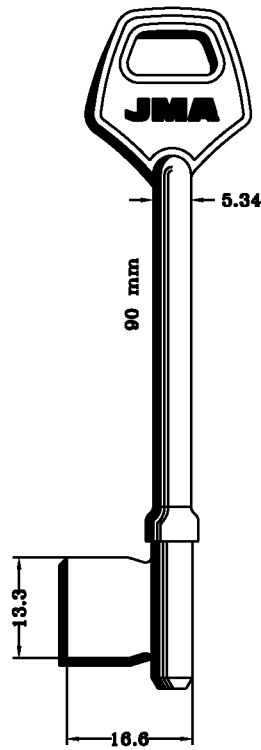

FA-5G

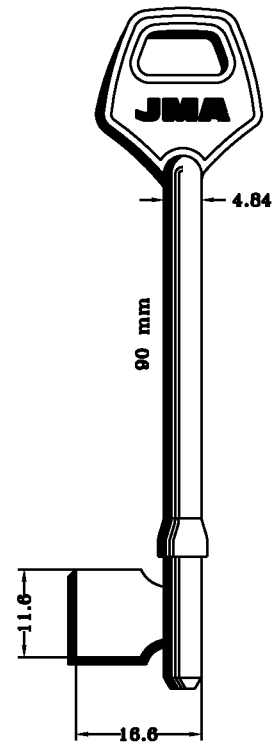

FA-6G

FAS-YALE  
(S)

FICHET (F)

GPZ (RUS)

GUARDIAN  
(GB)

PARA: FAS-YALE  
FOR:

FICHET

GPZ

GUARDIAN

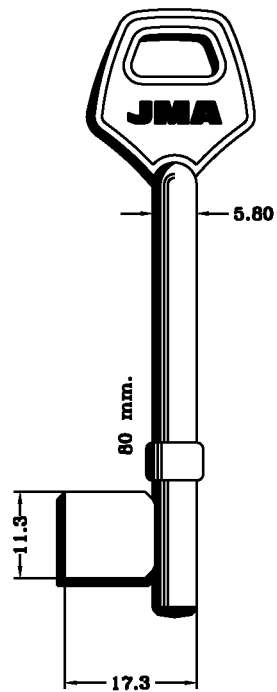

FA-7G

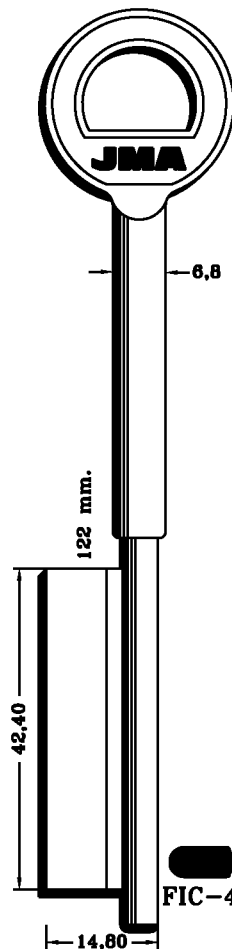

FIC-401G

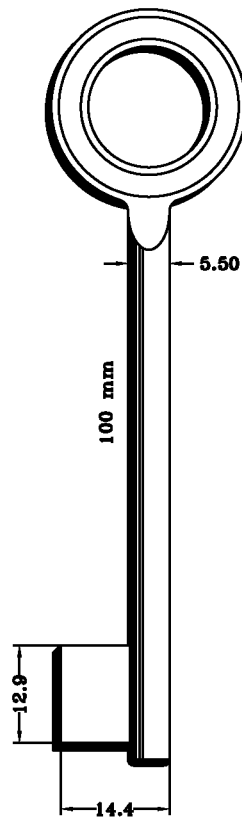

GPZ-1G

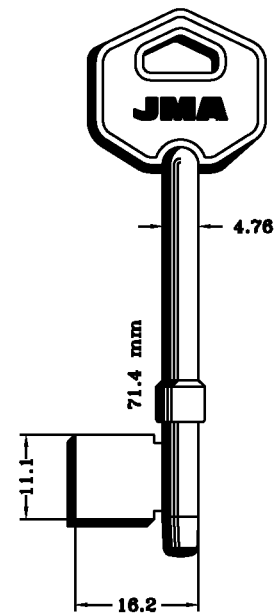

GUR-1G

Copyright by  
Alejandro Altuna S.A.  
2005

JMA

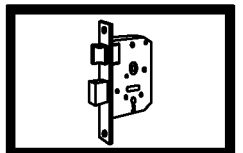

249

**PARA-FOR:**

**HENDERSON  
(GB)**

**LAR (E)**

**LÅSBOLAGET  
(S)**

**LINCE (E)**

**PARA:  
FOR: HENDERSON**

**LAR**

**LÅSBOLAGET**

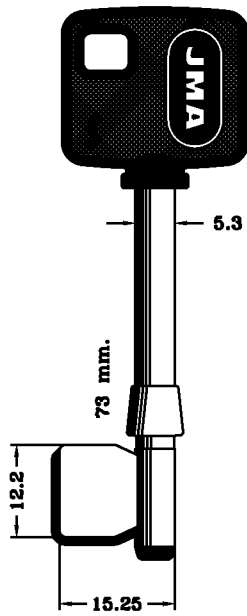

**HEN-1G.P**

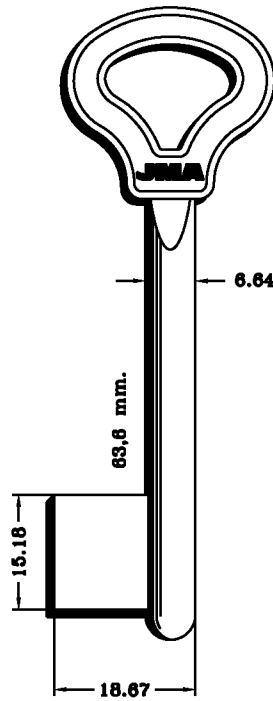

**LAR-1G**

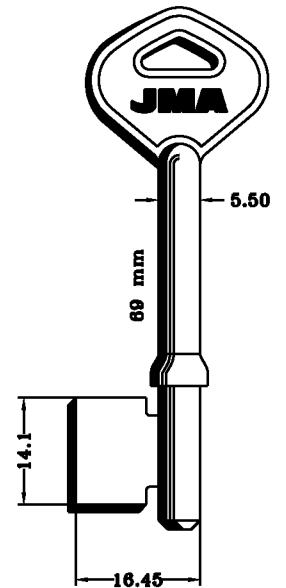

**LASB-1G**

**PARA:  
FOR:**

**LÅSBOLAGET**

**LINCE**

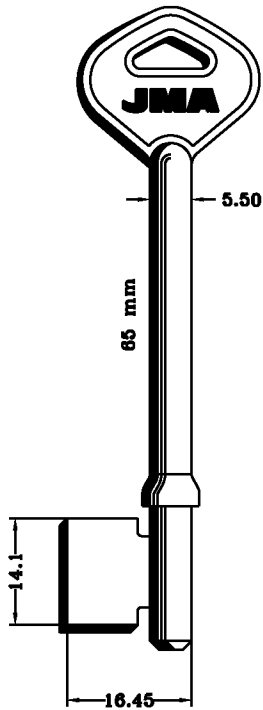

**LASB-2G**

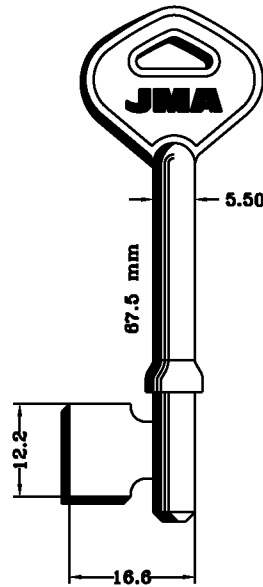

**LASB-3G**

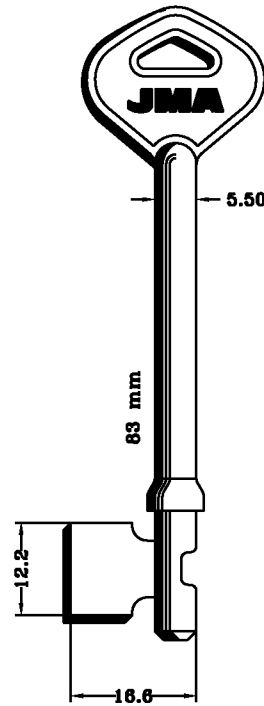

**LASB-4G**

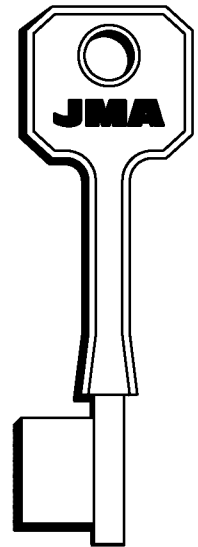

**LIN-1G**

Copyright by  
Alejandro Altuna S.A.  
2005

**JMA**

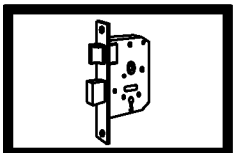

**250**

PARA: FOR:	MCM	MOSKVA	ORENGO
	<p>MCM-1G</p>	<p>MCM-4G</p>	<p>MOK-1G</p>
	<p>OR-3G</p>		

**PARA-FOR:**

**MCM (E)**

**MOSKVA (RUS)**

**ORENGO (E)**

**OSTMARK (D)**

**RENAG (N)**

PARA: FOR:	ORENGO	OSTMARK	RENAG
	<p>OR-6G</p>	<p>OST-1G</p>	<p>OST-2G</p>
	<p>REN-1G</p>		<p>REN-2G</p>

Copyright by  
Alejandro Altuna S.A.  
2005

**JMA**

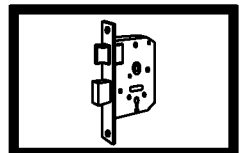

**251**

**PARA-FOR:**

PARA:  
FOR:

REX

TESA

REX (N)

TESA (E)

TRIO-VING  
(N)

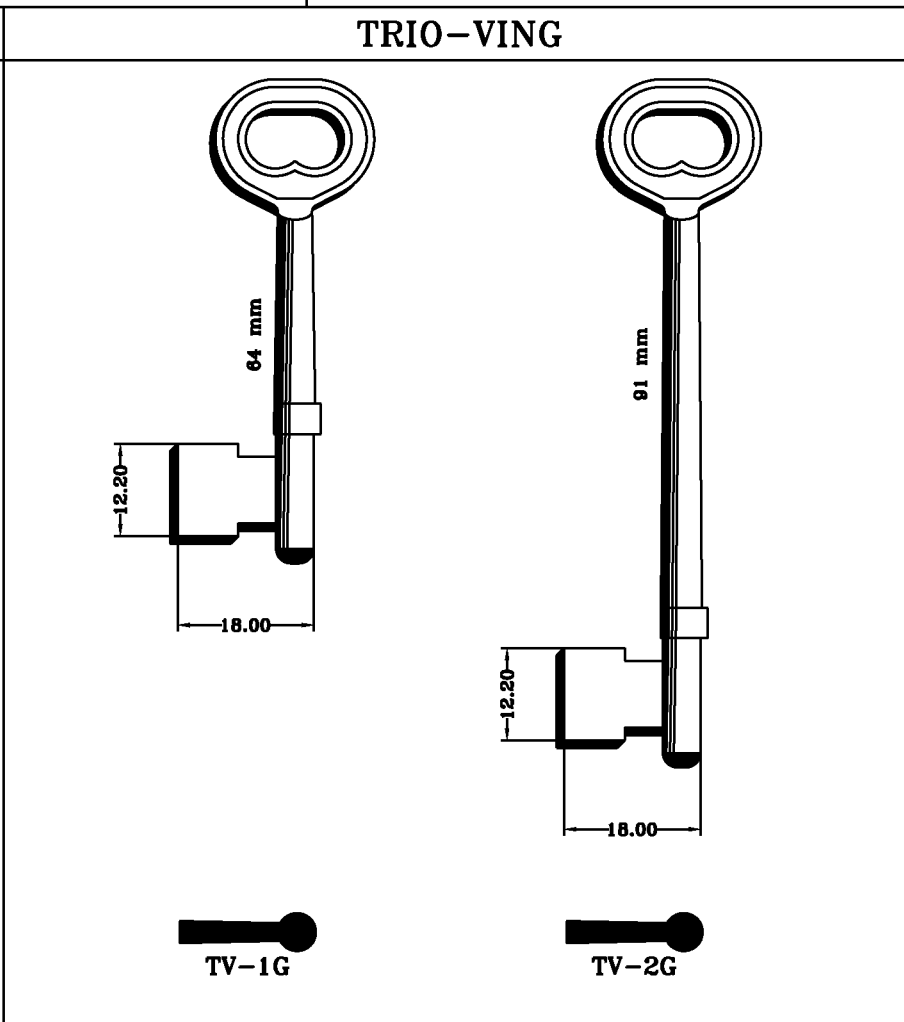
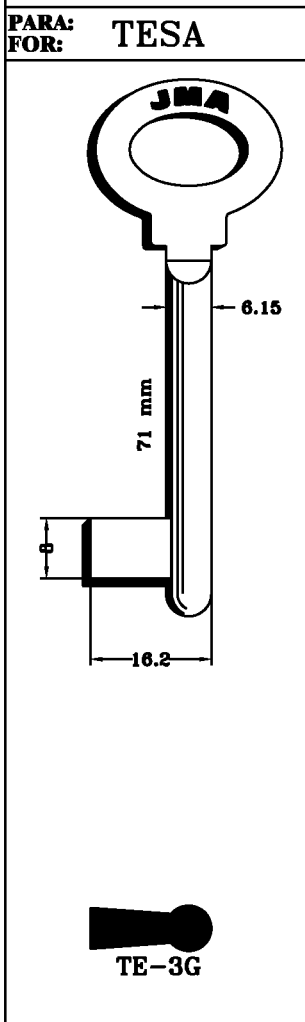
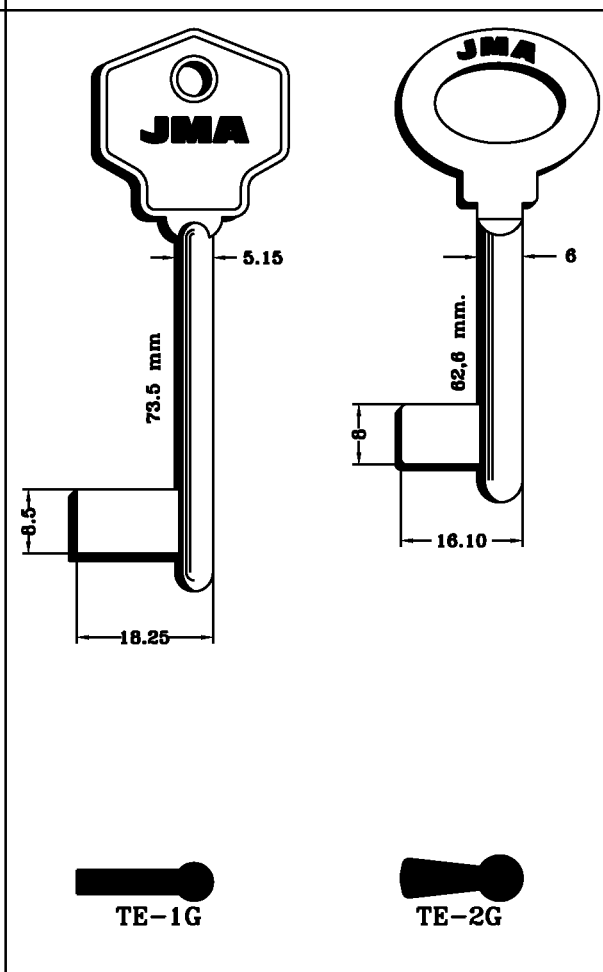
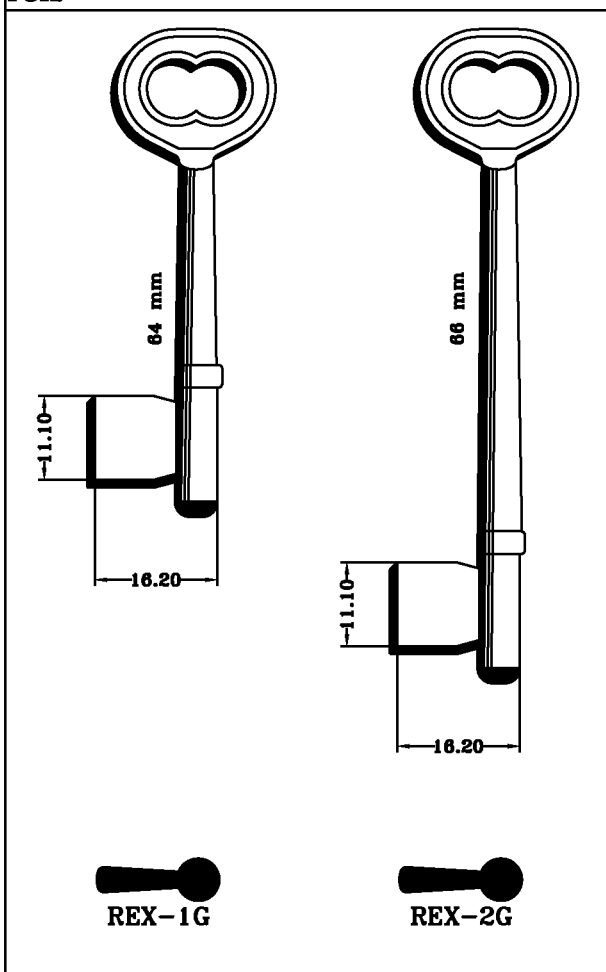

Copyright by  
Alejandro Altuna S.A.  
2005

**JMA**

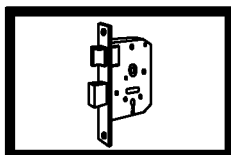

**252**

PARA:  
FOR:

### TRIO-VING

PARA-FOR:

### TRIO-VING (N)

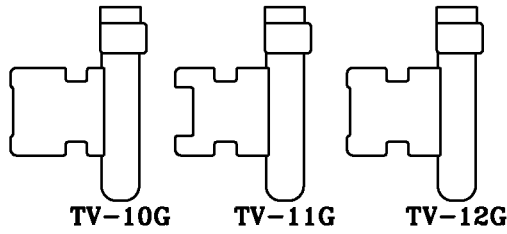
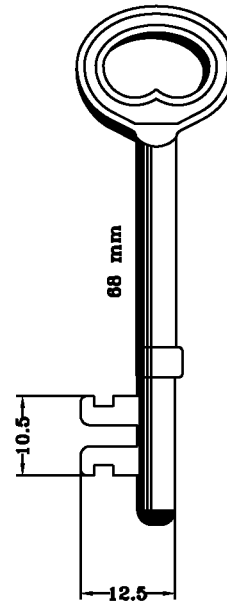
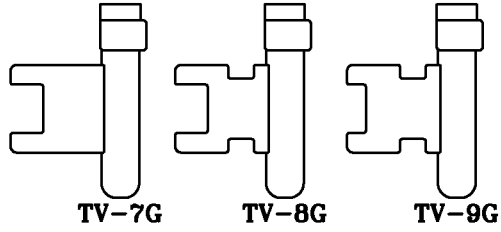
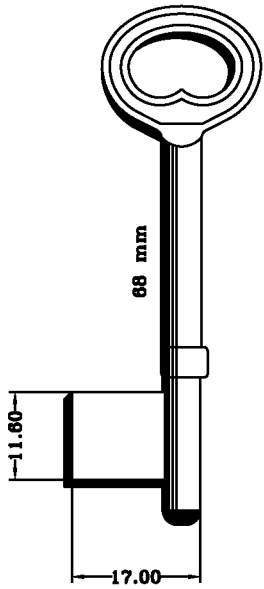

PARA:  
FOR:

### TRIO-VING

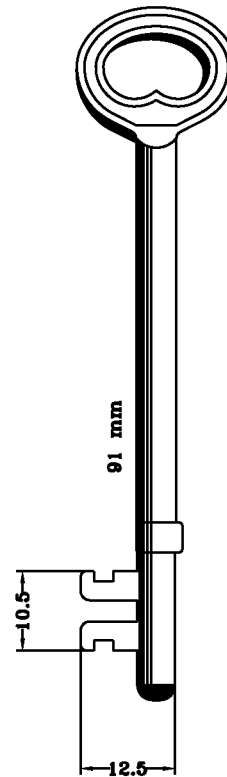
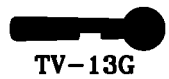
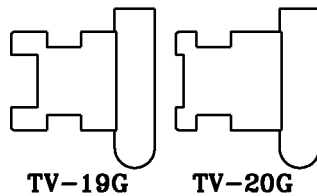
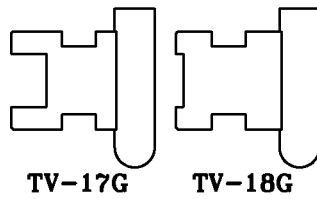
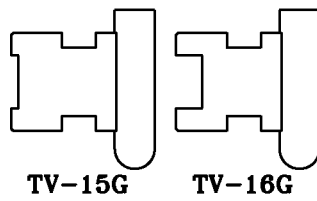
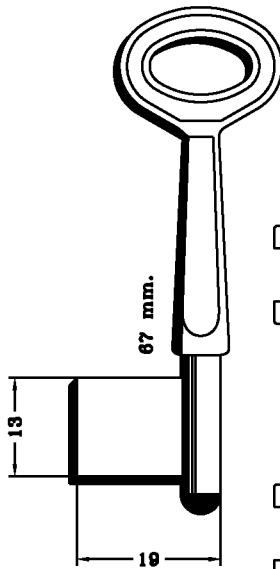
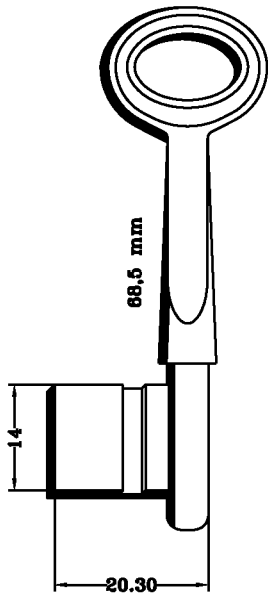

Copyright by  
Alejandro Altuna S.A.  
2005

# JMA

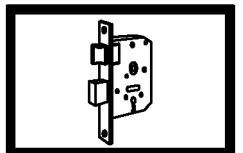

# 253

**PARA-FOR:**

PARA:  
FOR:

**TRIO-VING**

**UCEM**

**TRIO-VING  
(N)**

**UCEM (E)**

**UNION (GB)**

**WMS (GB)**

**YALE (GB)**

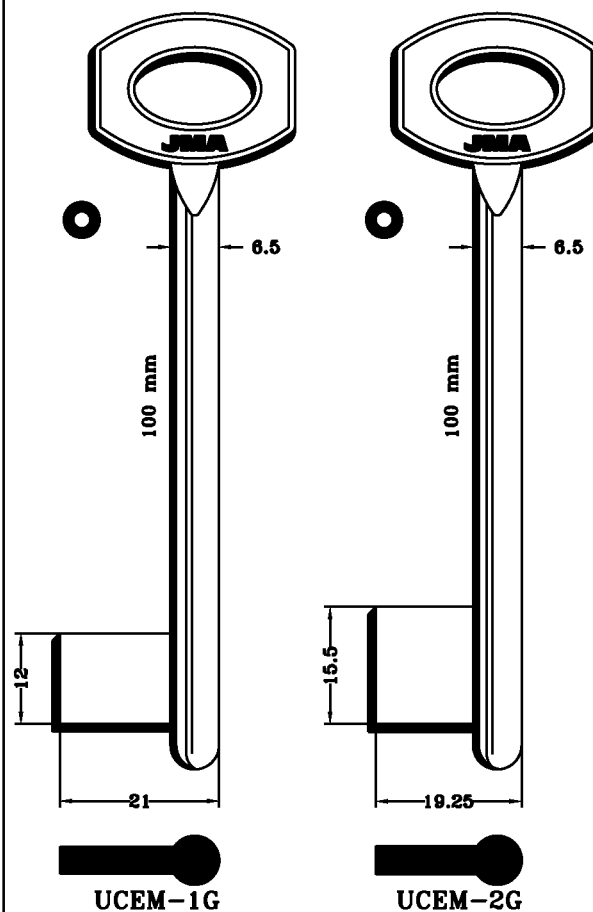
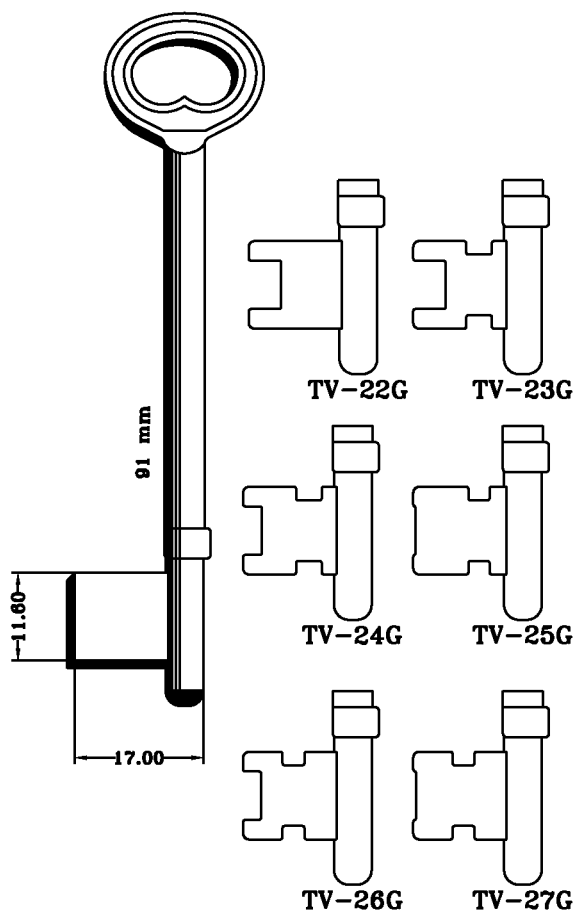

PARA:  
FOR:

**UCEM**

**UNION**

**WMS**

**YALE**

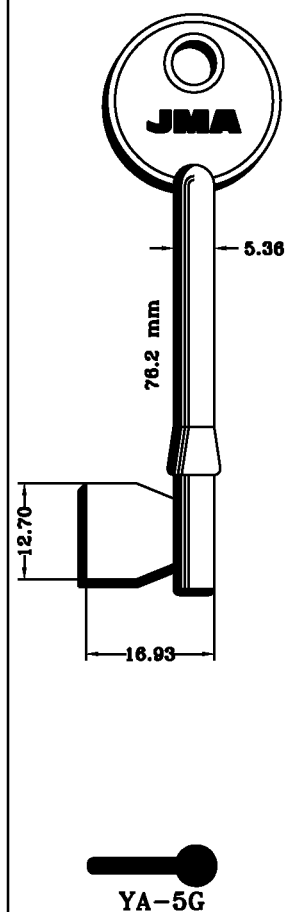
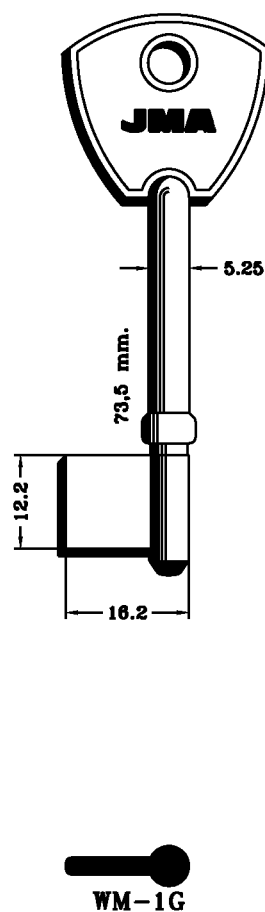
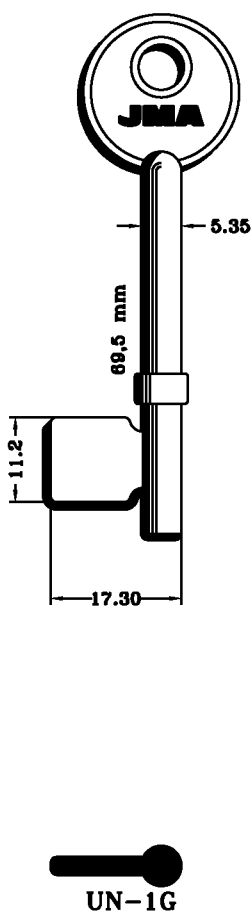
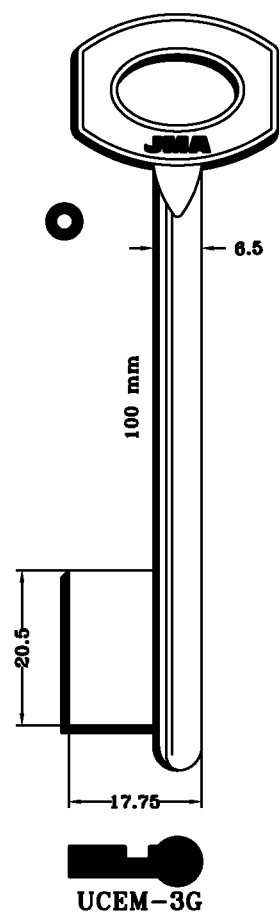

Copyright by  
Alejandro Altuna S.A.  
2005

**JMA**

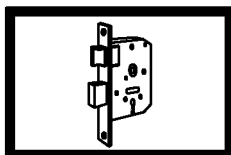

**254**

PARA:  
FOR:

# ANTONIOLI

PARA-FOR:

ANTONIOLI  
(I)

ASSA (S)

ATRA (I)

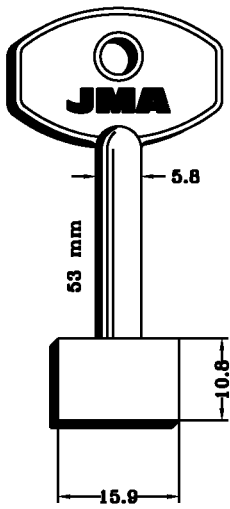

ANT-1G

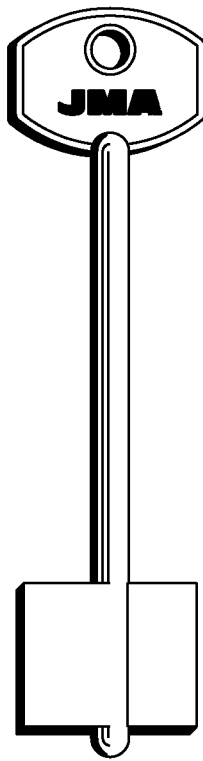

ANT-2G

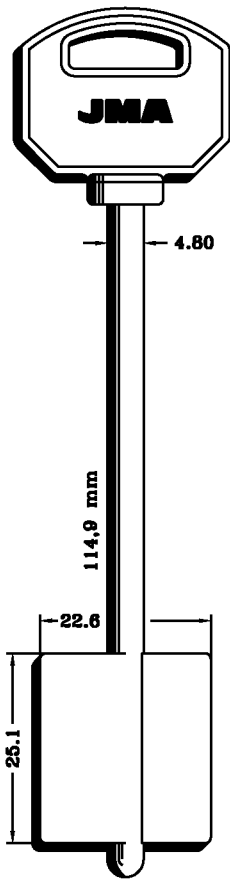

ANT-3G

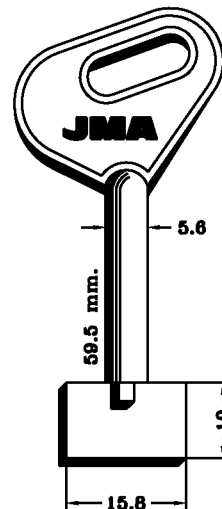

ANT-4G

AUNO

PARA:  
FOR: ANTONIOLI

ASSA

ATRA

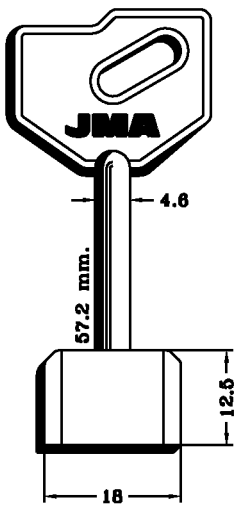

ANT-5G

AUNO

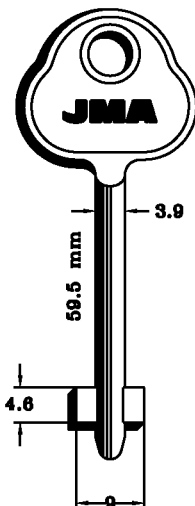

AS-4G

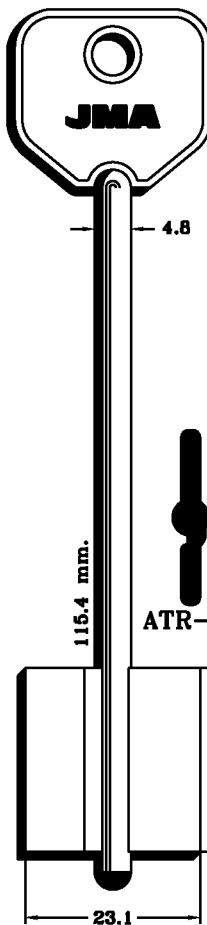

ATR-1G

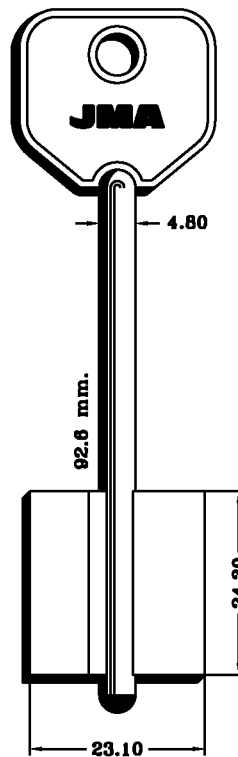

ATR-2G

Copyright by  
Alejandro Altuna S.A.  
2005

# JMA

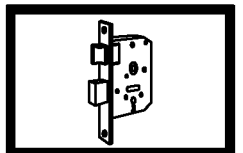

# 255

**PARA-FOR:**

**ATRA (I)**

**BETA (I)**

**BMC (I)**

**PARA: FOR:** **ATRA**

115 mm.  
4.80  
24.30  
23.10

**ATR-2TG**

**BETA**

**BE-1G**  
**BE-2G**  
**BE-3G**  
**BE-4G**

**PARA: FOR:** **BETA**

104.24 mm.  
4.8  
23.10

**BE-5G**  
**BE-6G**

**BMC**

**BMC-1G**

Copyright by  
Alejandro Altuna S.A.  
2005

**JMA**

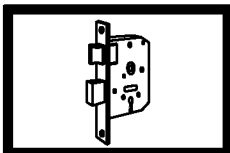

**256**

PARA:  
FOR:

**BODA**

**BOGATIR**

**PARA-FOR:**

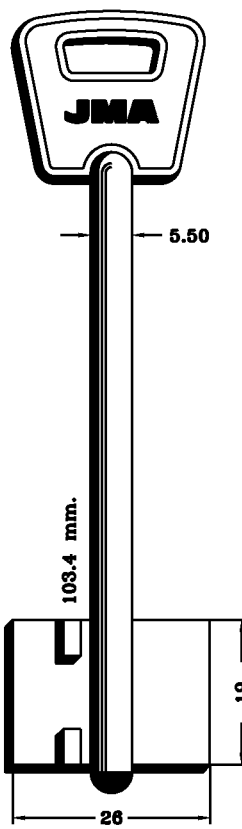
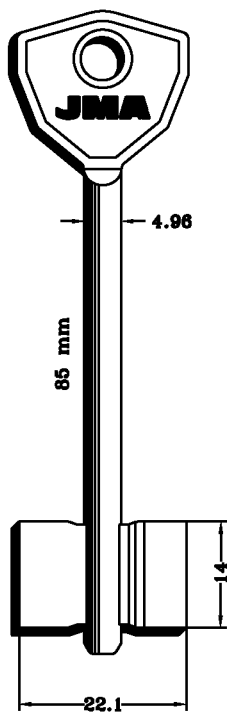
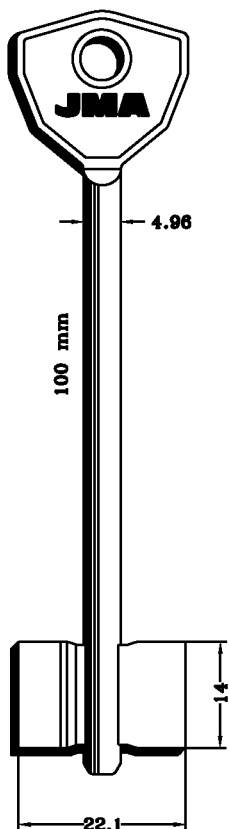
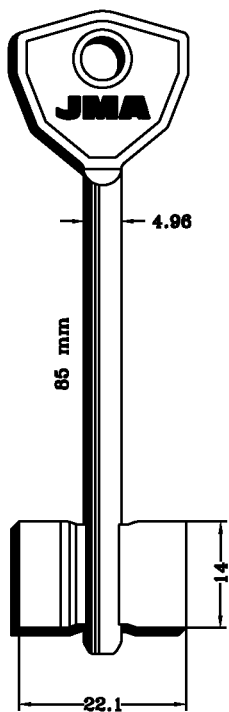

- BODA (SF)**
- BOGATIR (RUS)**
- BOXAFE (I)**
- CAF (I)**
- CERUTTI (I)**

PARA:  
FOR: **BOXAFE**

**CAF**

**CERUTTI**

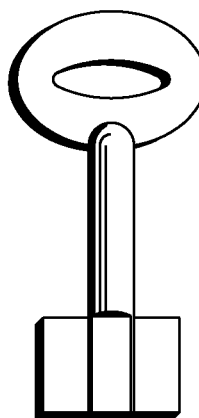
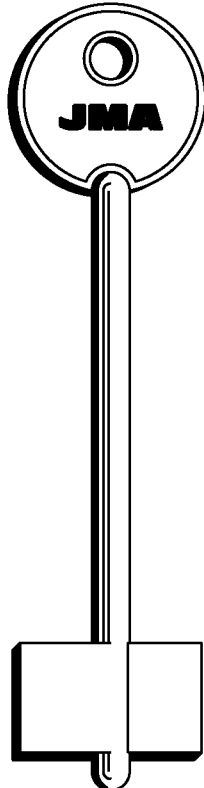
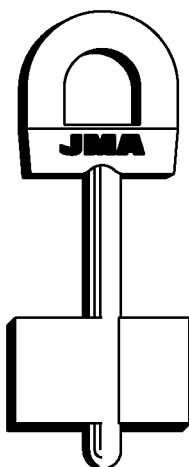
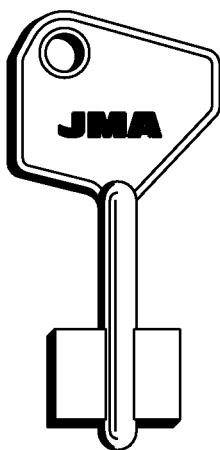

Copyright by  
Alejandro Altuna S.A.  
2005

**JMA**

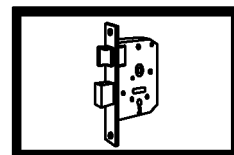

**257**

**PARA-FOR:**

**PARA:  
FOR:**

**CERUTTI**

**CERUTTI (I)**

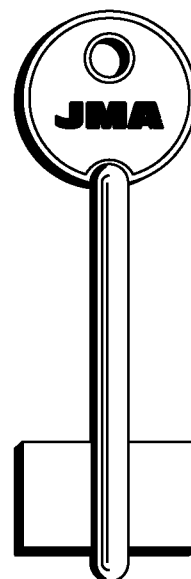
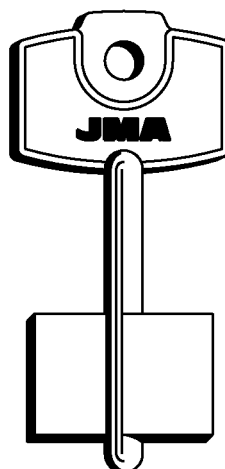
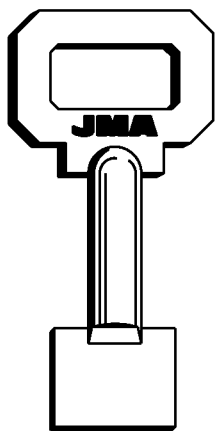

**CRT-2G**



**CRT-3G**



**CRT-4G**



**CRT-6G**

**PARA:  
FOR:**

**CERUTTI**

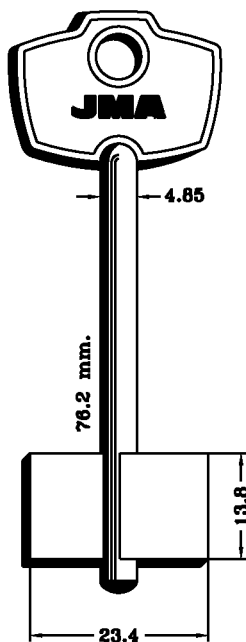

**CRT-7G**

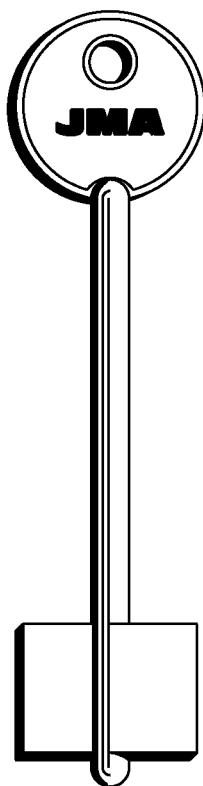

**CRT-8G**

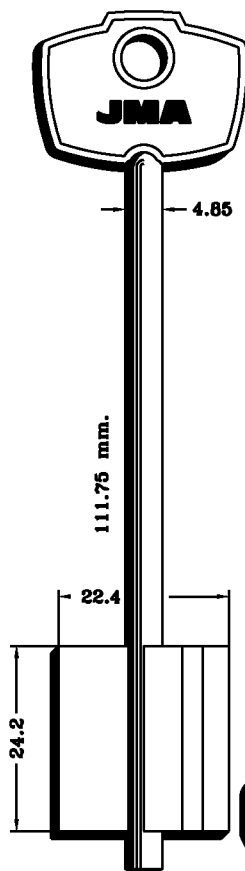

**CRT-11G**

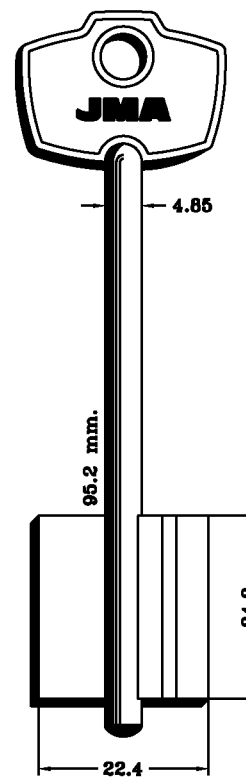

**CRT-12G**

Copyright by  
Alejandro Altuna S.A.  
2005

**JMA**

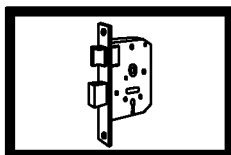

**258**

PARA:  
FOR:

### CERUTTI

PARA-FOR:

CERUTTI (I)

CHUBB (GB)

CISA (I)

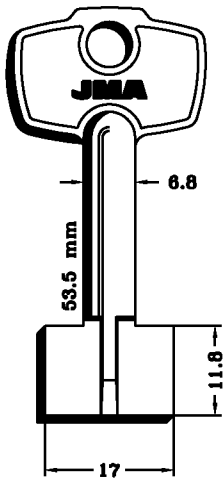

CRT-13G

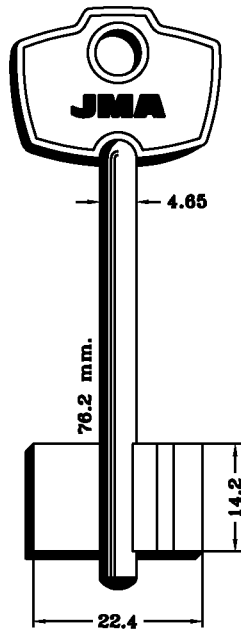

CRT-14G



CRT-14G

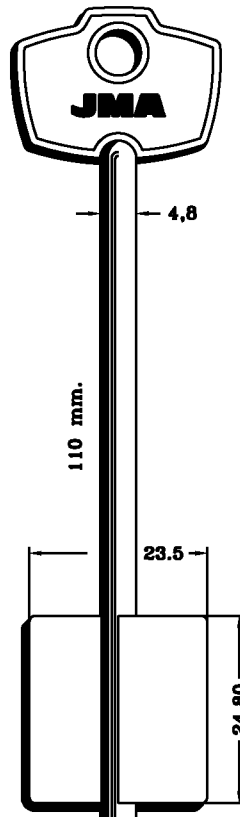

CRT-17G

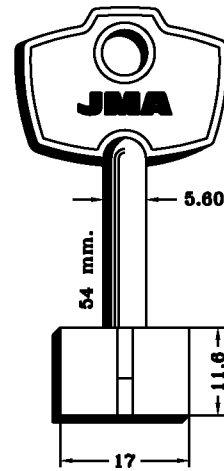

CRT-18G

PARA:  
FOR:

### CHUBB

### CISA

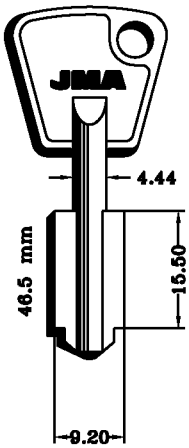

CHU-4G

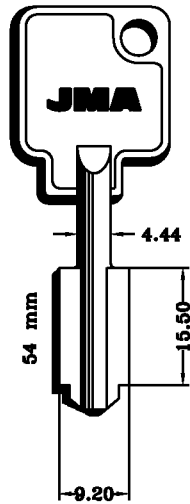

CHU-5G

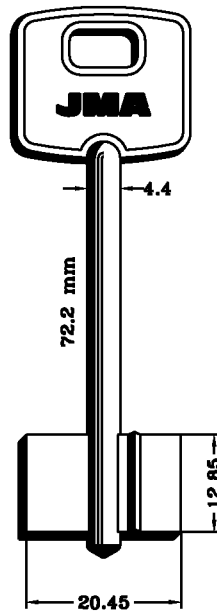

CI-1G



CI-1G

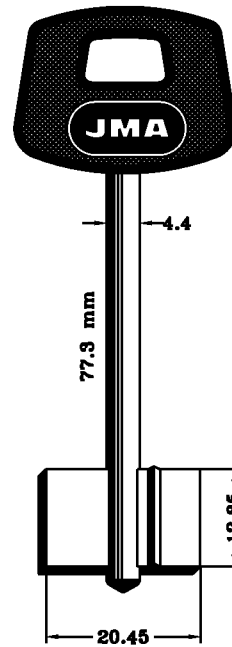

CI-1PG

Copyright by  
Alejandro Altuna S.A.  
2005

# JMA

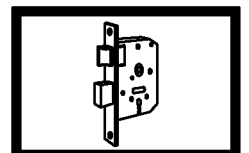

## 259

**PARA-FOR:**

**PARA:  
FOR:**

**CISA**

**CISA (I)**

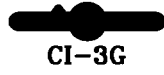
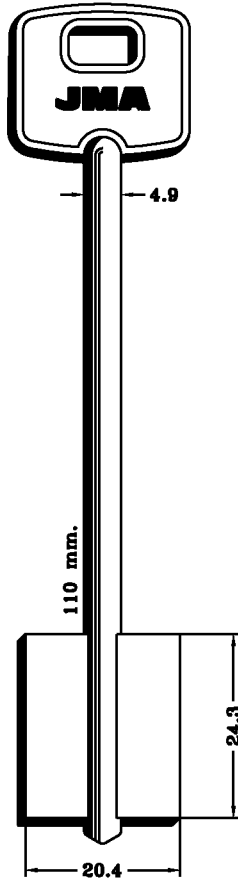

CI-3G

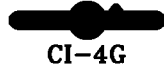

CI-4G

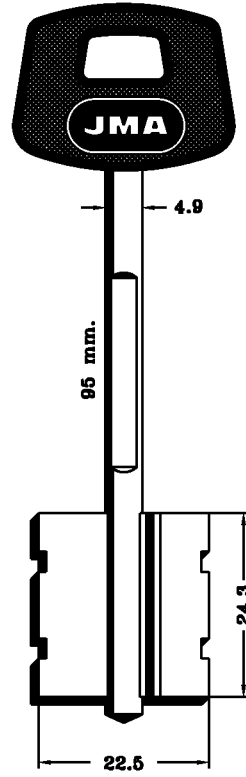

CI-5PG

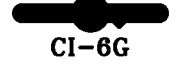
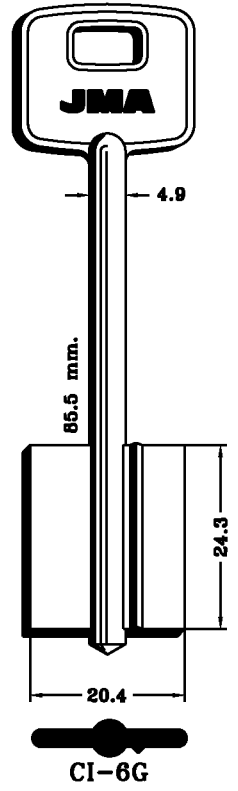

CI-6G



CI-10G

**PARA:  
FOR:**

**CISA**

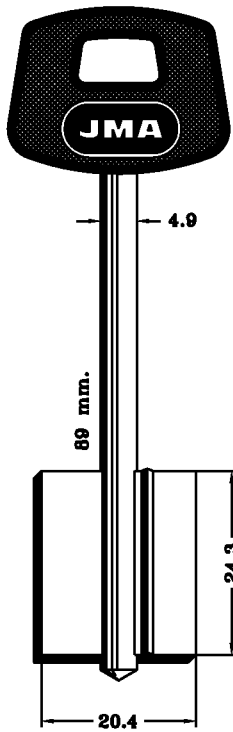

CI-6PG

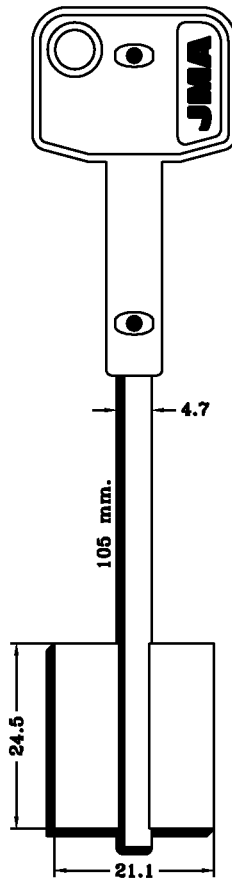

CI-7TG



CI-12TG

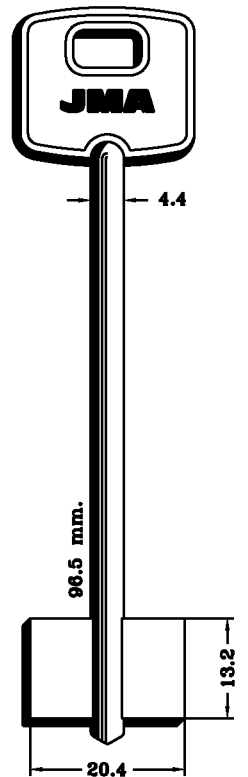

CI-8G

Copyright by  
Alejandro Altuna S.A.  
2005

**JMA**

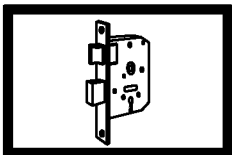

**260**

ATENCION:Concerniente a las marcas y denominaciones comerciales ver nota en indice.ATTENTION:Concerning the marks and commercial denominations see note in Index.  
ATTENTION:Concernant les marques et denominations commerciales voir la note dans l'Index.ACHTUNG:Beziehen auf die marke und handelsname sehen sie die notiz im Index.

PARA: FOR:	CISA	CLASS	CORBIN	CORNI
	<p>CI-9PG</p>	<p>CLA-3G</p>	<p>COR-1G</p>	<p>CRN-1G</p>

**PARA-FOR:**

- CISA (I)
- CLASS (RUS)
- CORBIN (I)
- CORNI (I)
- CR (I)

PARA: FOR:	CR			
	<p>CR-1G</p>	<p>CR-2G</p>	<p>CR-3G</p>	<p>CR-4G</p>

Copyright by  
Alejandro Altuna S.A.  
2005

**JMA**

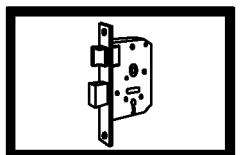

**261**

**PARA-FOR:**

**PARA:  
FOR:**

**CR**

**CR (I)**

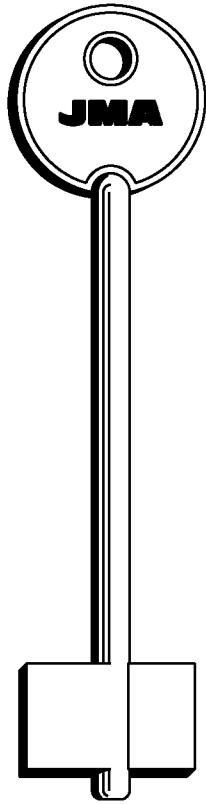

**CR-5G**

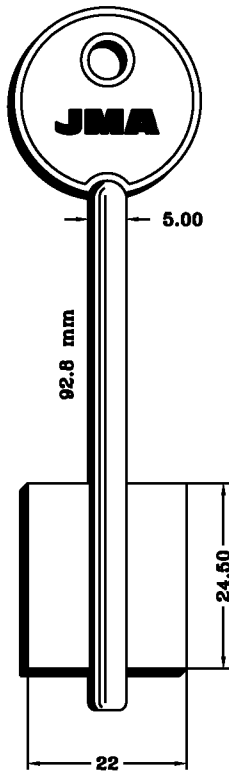

**CR-7G**

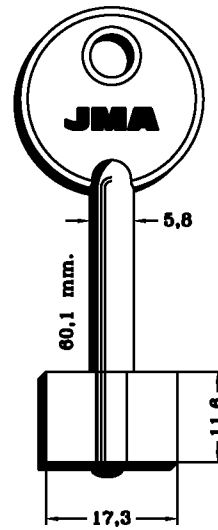

**CR-8G**

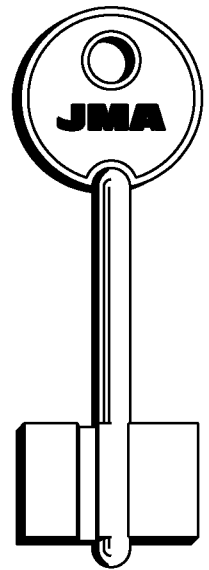

**CR-9G**



**CR-10G**

**PARA:  
FOR:**

**CR**

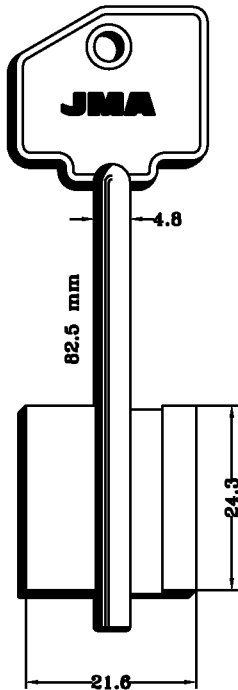

**CR-11G**

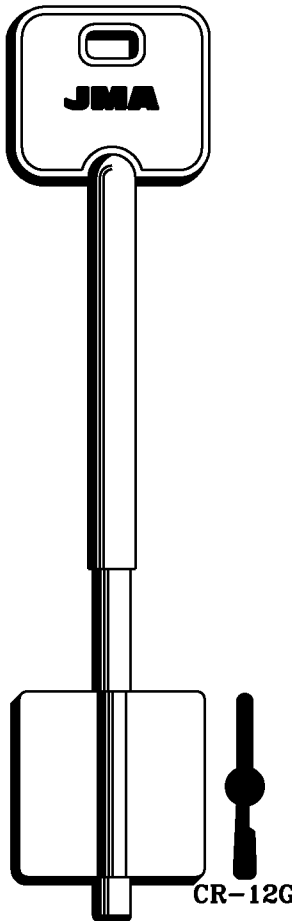

**CR-12G**

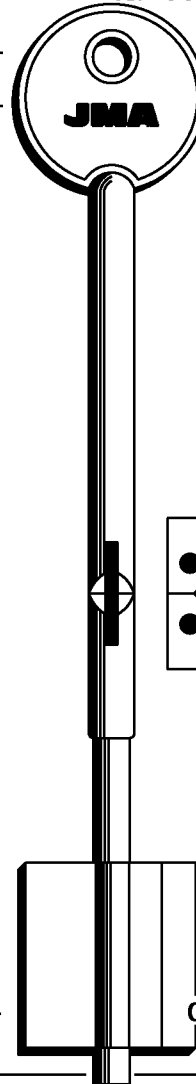

**CR-13TG**

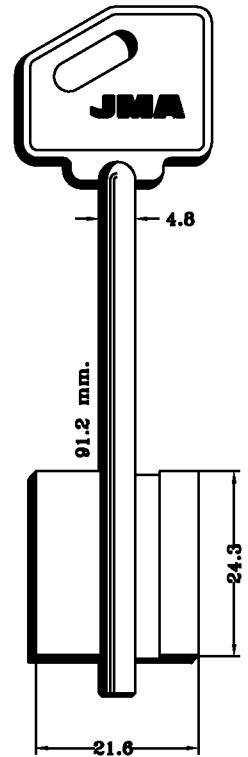

**CR-14G**

Copyright by  
Alejandro Altuna S.A.  
2005

**JMA**

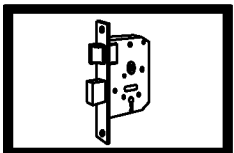

**262**

ATENCION:Concerniente a las marcas y denominaciones comerciales ver nota en indice.ATTENTION:Concerning the marks and commercial denominations see note in index.  
ATTENTION:Concernant les marques et denominations commerciales voir la note dans l'index.ACHTUNG:Beziehen auf die marke und handelsname sehen sie die notiz im index.

PARA:  
FOR:

### DVERNIAK

PARA-FOR:

DVERNIAK  
(RUS)

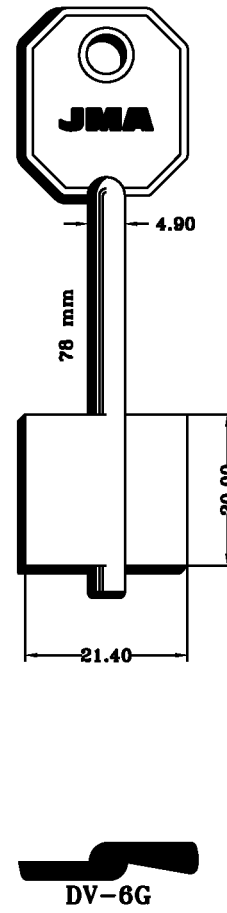
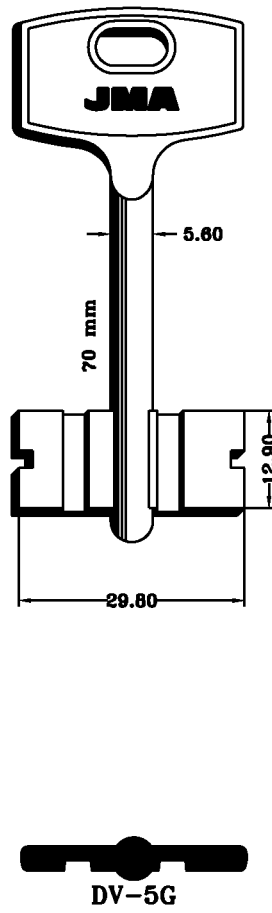
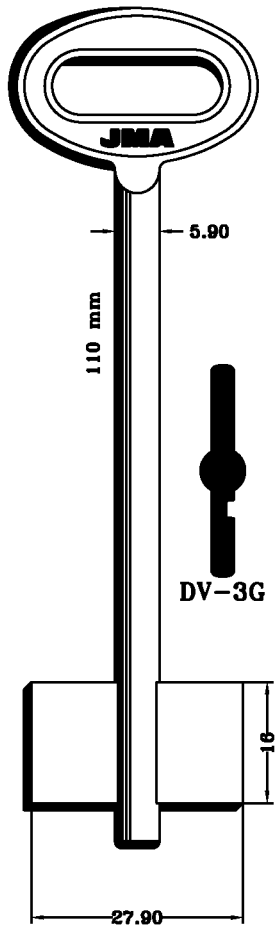
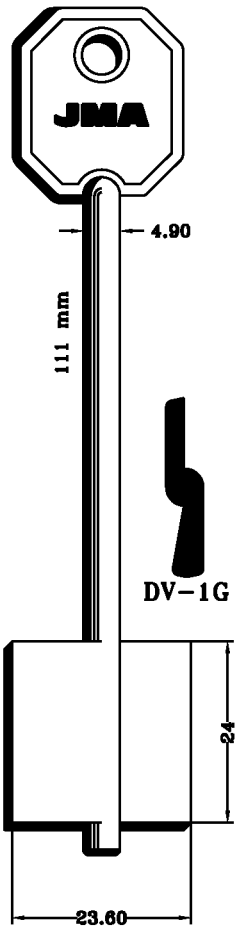

PARA:  
FOR:

### DVERNIAK

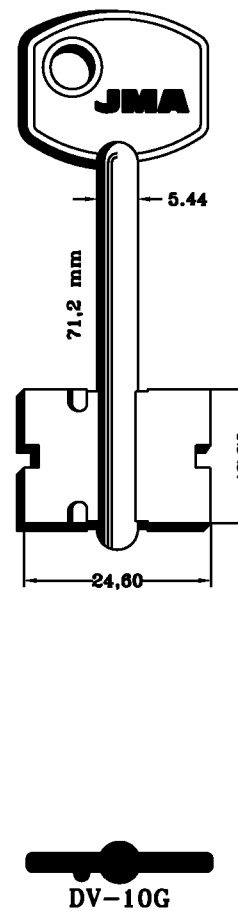
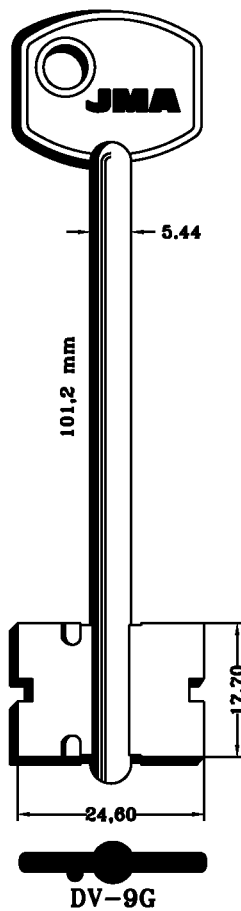
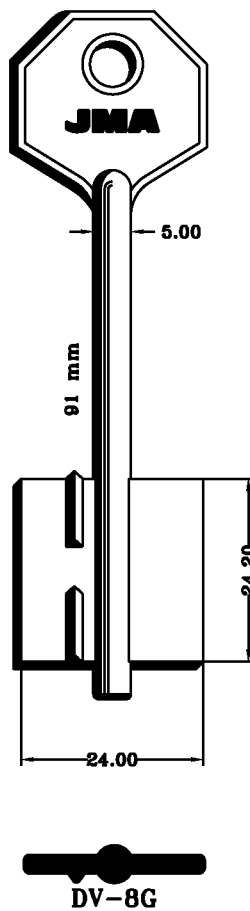
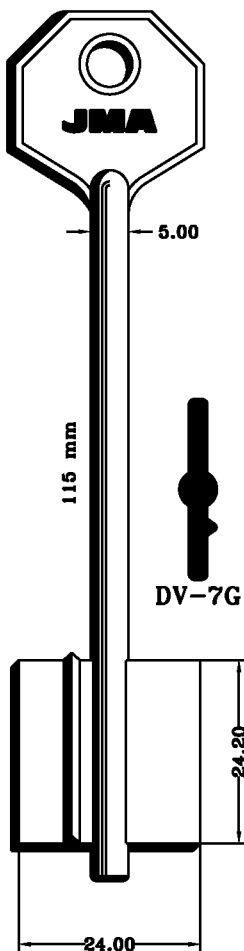

Copyright by  
Alejandro Altuna S.A.  
2005

JMA

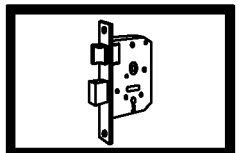

263

**PARA-FOR:**

**PARA:  
FOR:**

**DVERNIAK**

**DVERNIAK  
(RUS)**

**ELBOR (RUS)**

**ELZETT (H)**

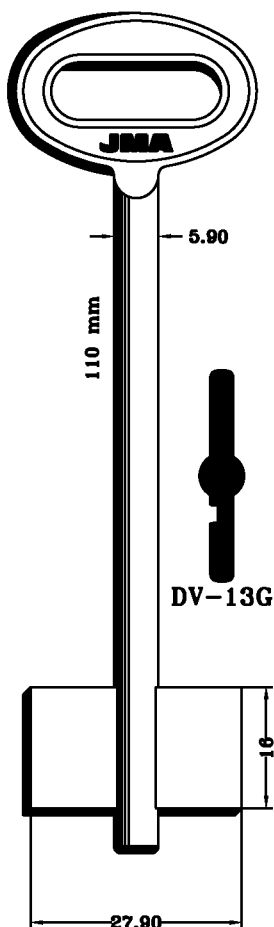
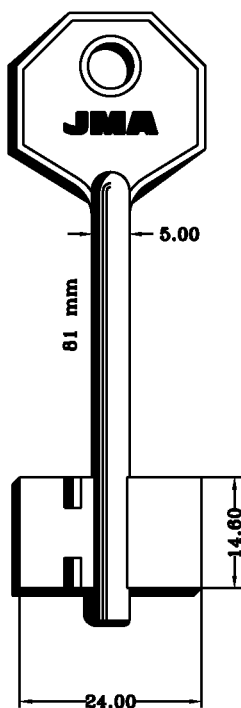

**DV-13G**

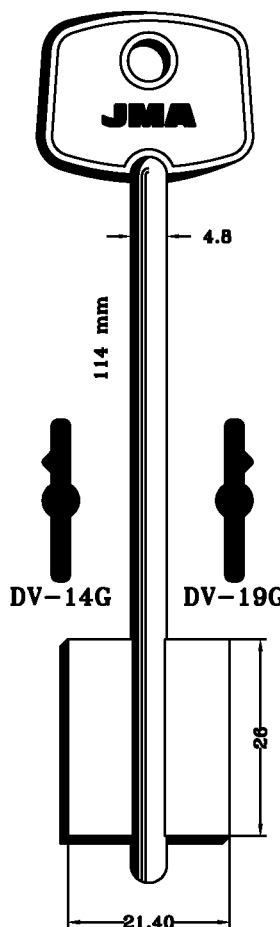

**DV-14G**

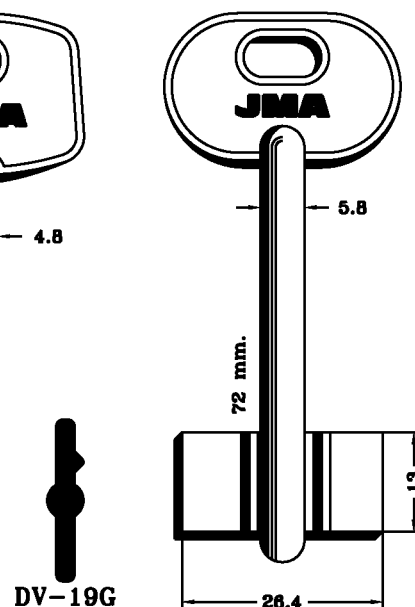

**DV-19G**



**PARA:  
FOR:**

**DVERNIAK**

**ELBOR**

**ELZETT**

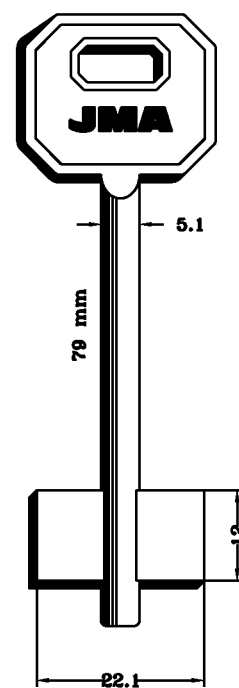
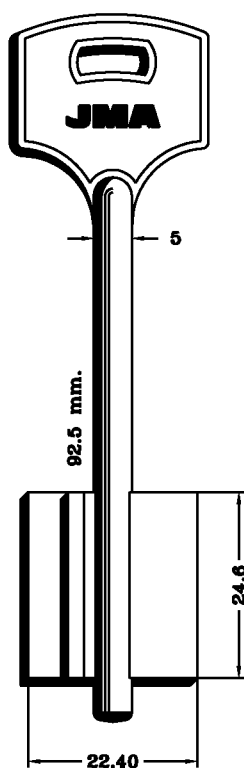
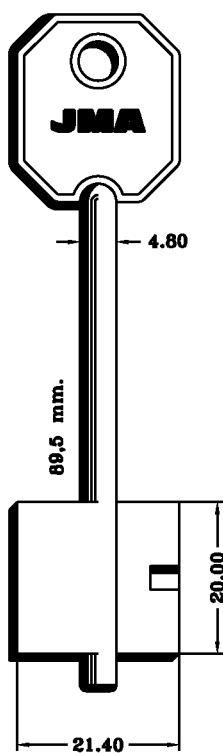
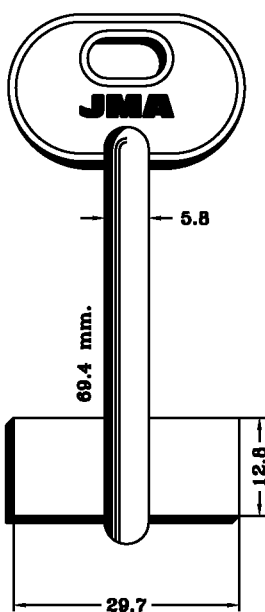

Copyright by  
Alejandro Altuna S.A.  
2005

**JMA**

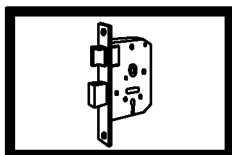

**264**

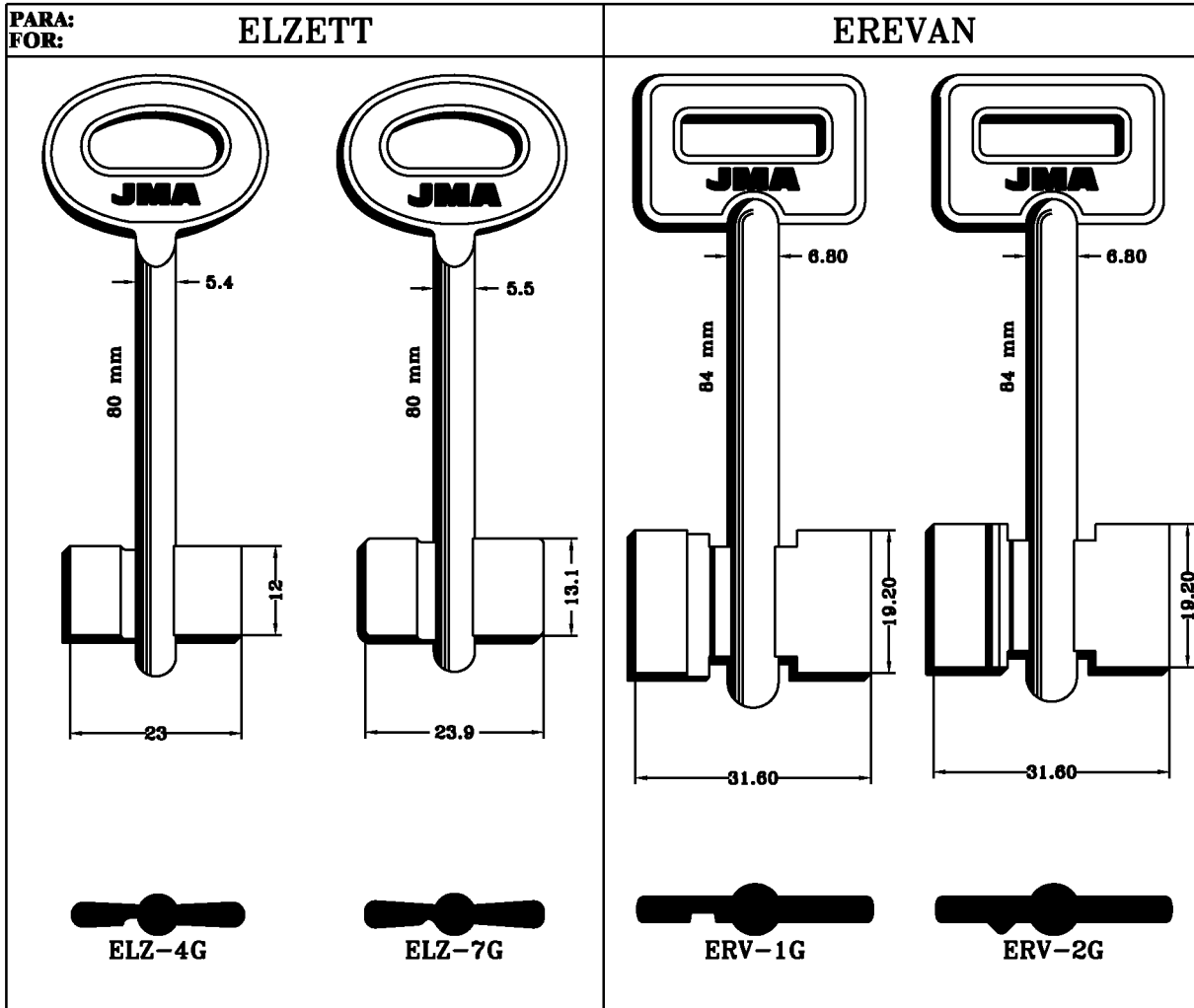

**PARA-FOR:**  
**ELZETT (H)**  
**EREVAN (RUS)**  
**ESETY (I)**

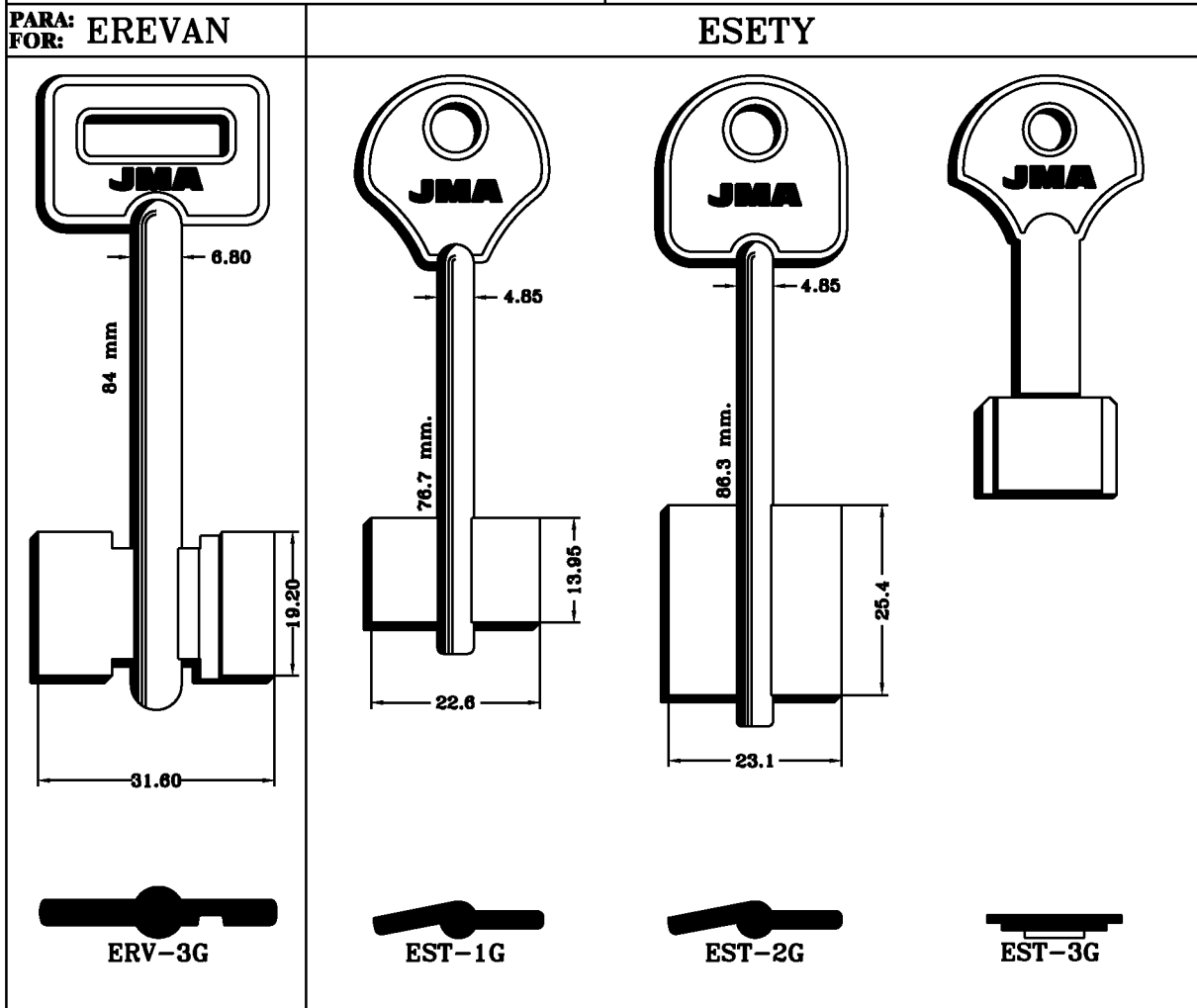

Copyright by  
Alejandro Altuna S.A.  
2005

**JMA**

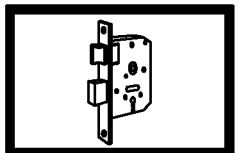

**265**

**PARA-FOR:**

**PARA:  
FOR:**

**ESETY**

**ESETY (I)**

**EUROTEMPLE  
(I)**

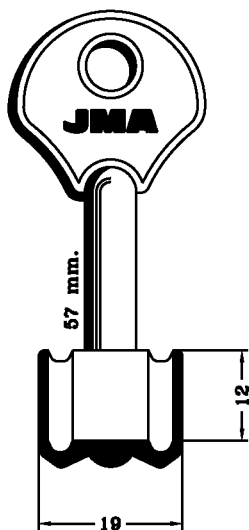

**EST-4G**

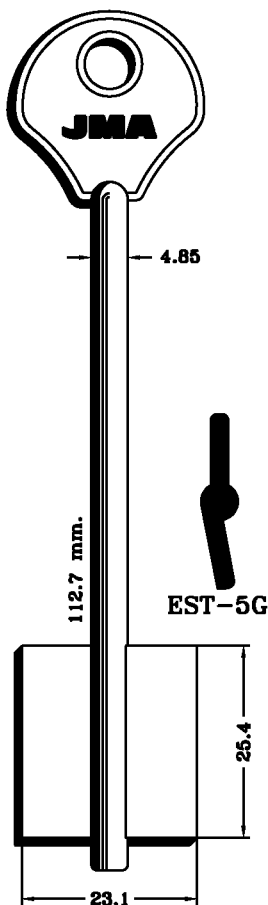

**EST-5G**

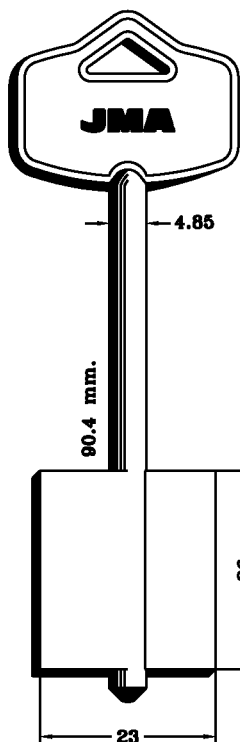

**EST-6G**

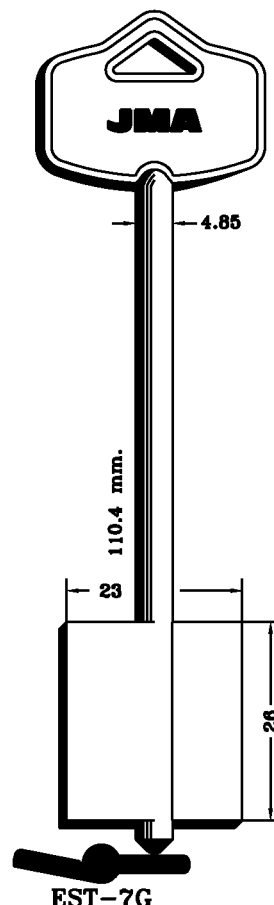

**EST-7G**

**PARA:  
FOR:** **ESETY**

**EUROTEMPLE**

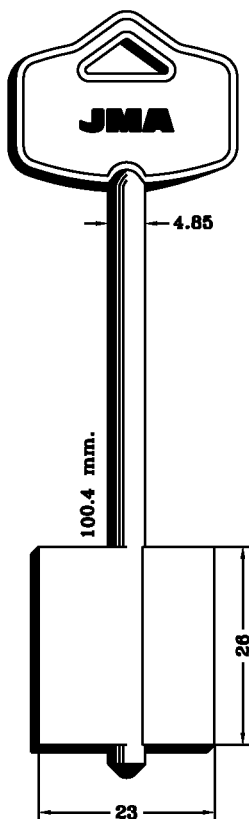

**EST-10G**

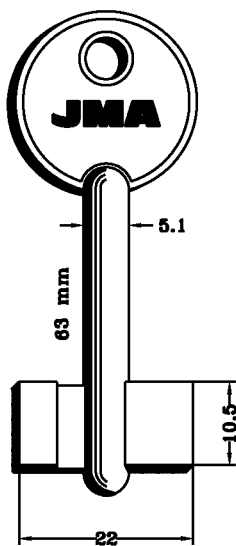

**EUT-1G**

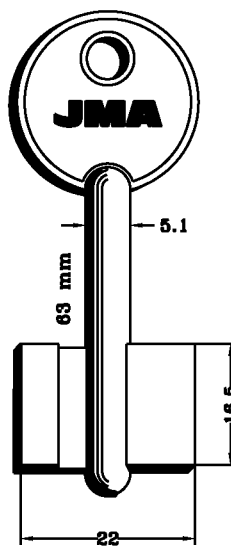

**EUT-2G**

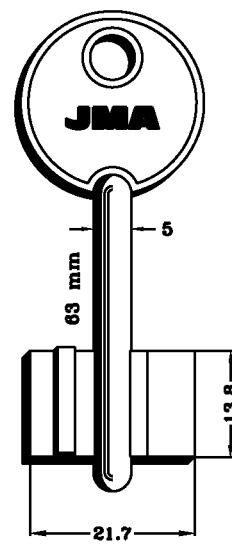

**EUT-3G**

Copyright by  
Alejandro Altuna S.A.  
2005

**JMA**

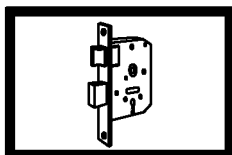

**266**

**ATENCION:**Concerniente a las marcas y denominaciones comerciales ver nota en indice.**ATTENTION:**Concerning the marks and commercial denominations see note in Index.  
**ATTENTION:**Concernant les marques et denominations commerciales voir la note dans l'Index.**ACHTUNG:**Beziehen auf die marke und handelsname sehen sie die notiz im Index.

PARA:  
FOR:

### EZCURRA

PARA-FOR:

EZCURRA (E)

FAC (E)

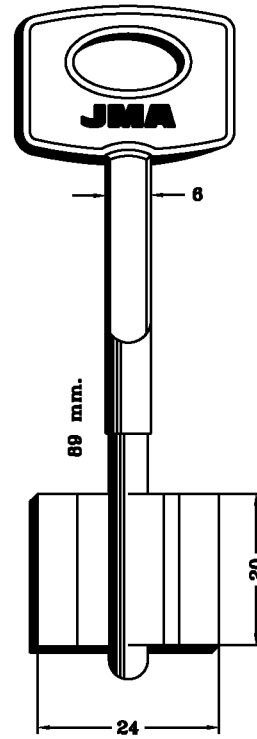
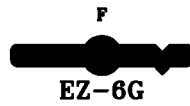
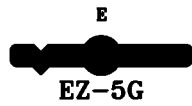
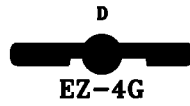
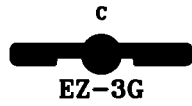
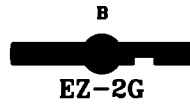
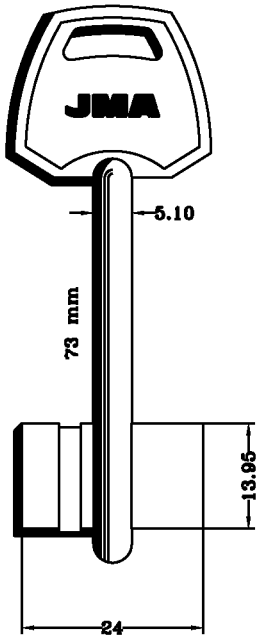

PARA: EZCURRA  
FOR:

### FAC

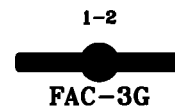
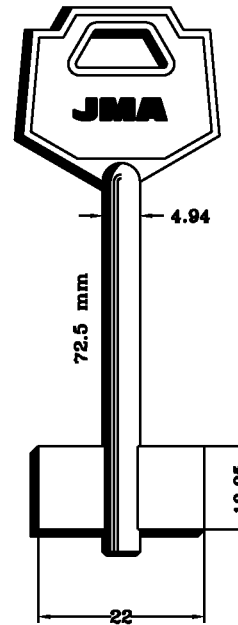
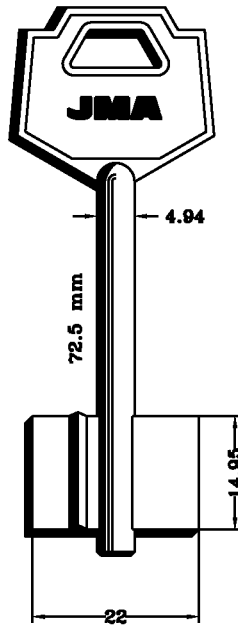
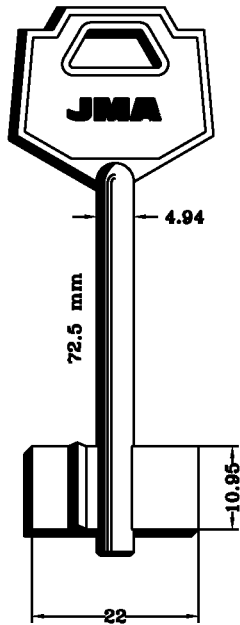
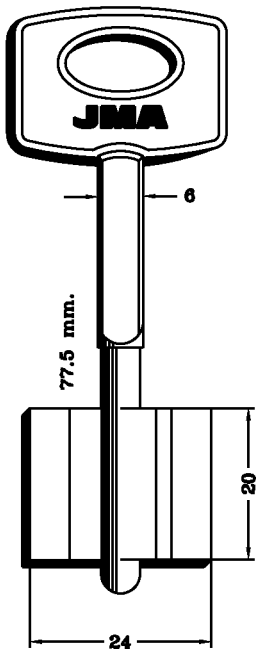

Copyright by  
Alejandro Altuna S.A.  
2005

# JMA

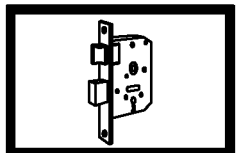

# 267

**PARA-FOR:**

PARA:  
FOR:

FAC

FACEF

FEB

FAC (E)

FACEF (I)

FEB (I)

FETIS (E)

FIAM (I)

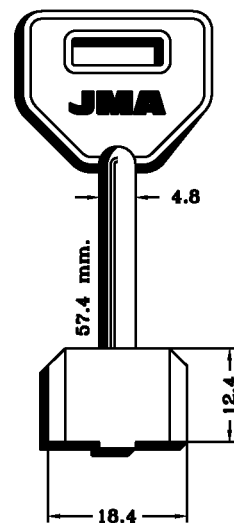
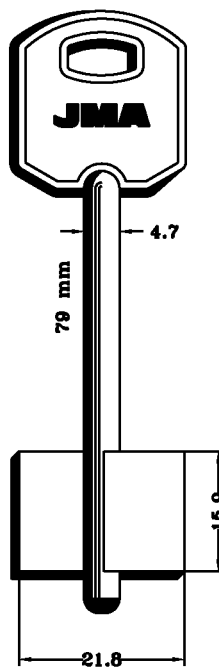
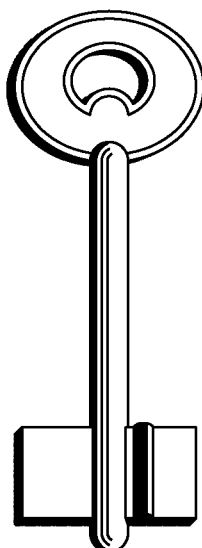
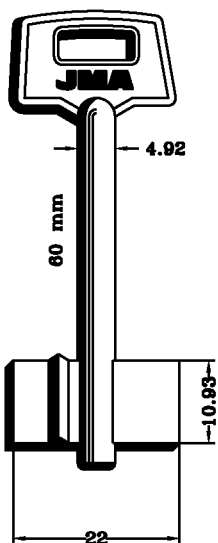

PARA:  
FOR:

FETIS

FIAM

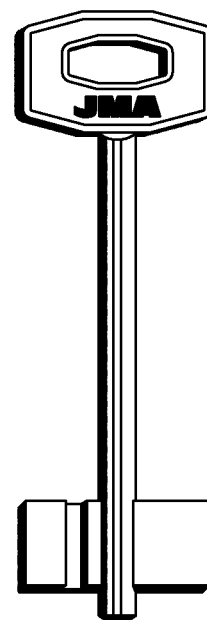
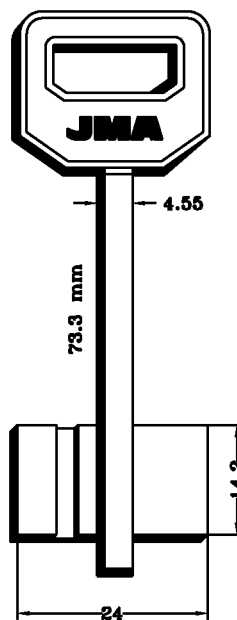
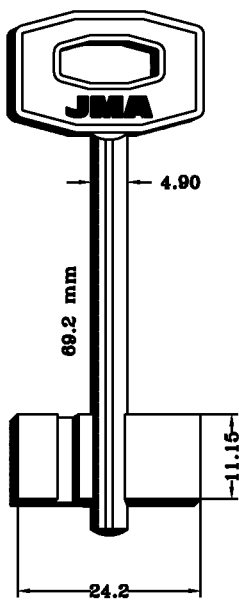
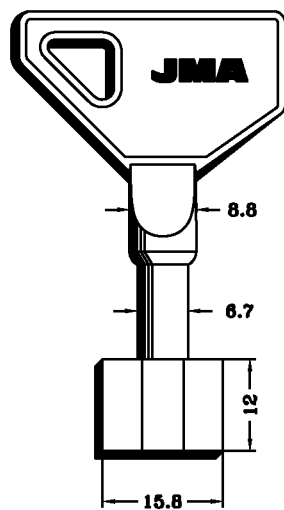

Copyright by  
Alejandro Altuna S.A.  
2005

**JMA**

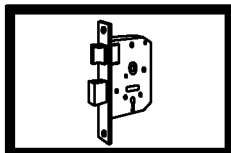

**268**

PARA:  
FOR:

### FIAM

PARA-FOR:

### FIAM (I)

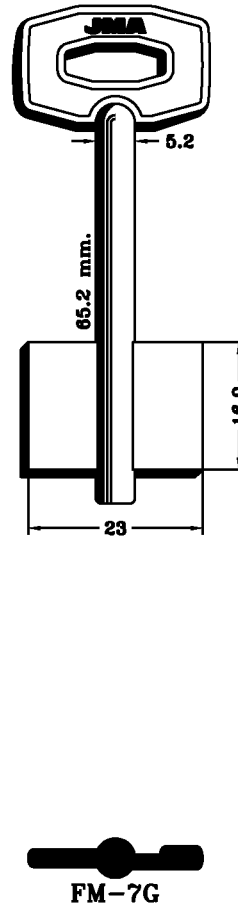
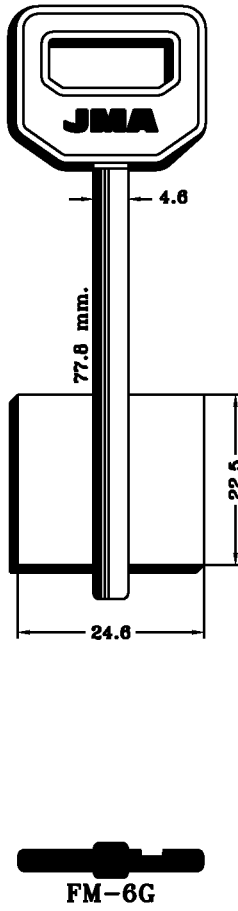
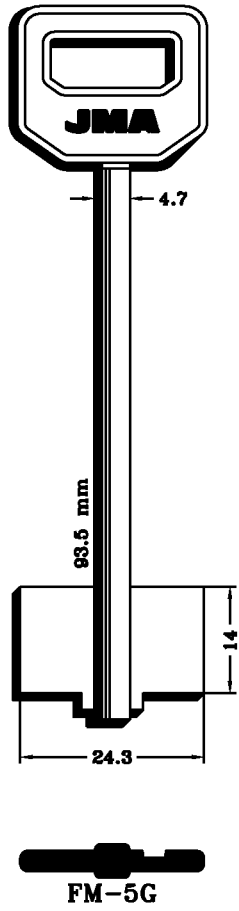
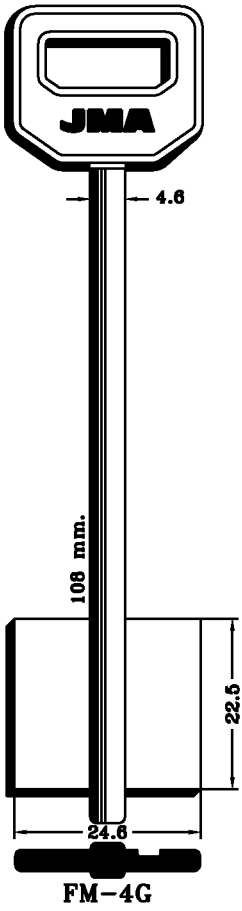

PARA:  
FOR:

### FIAM

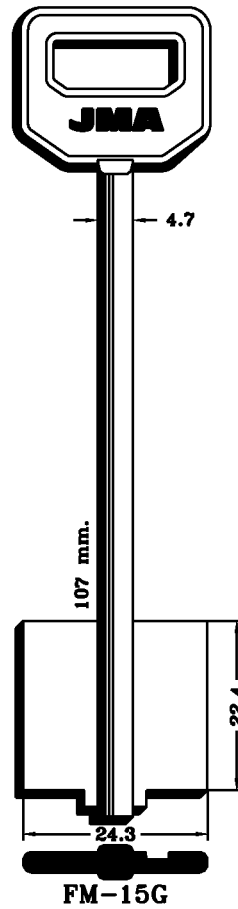
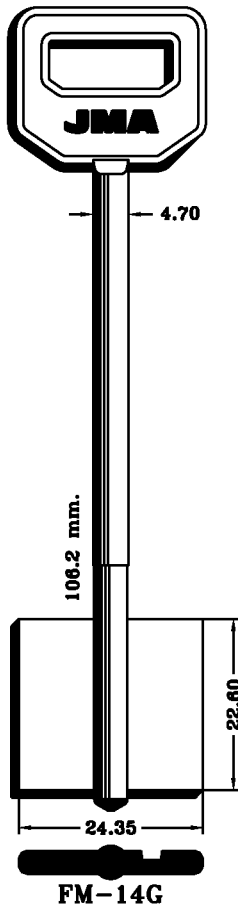
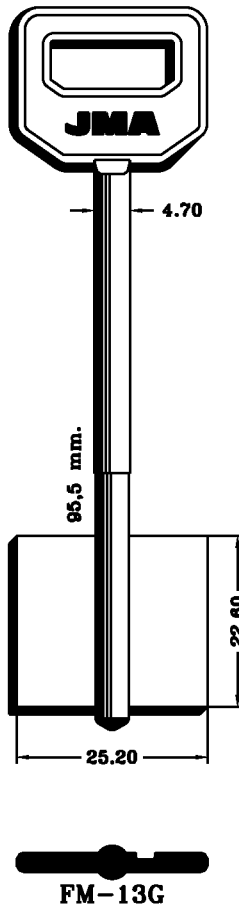
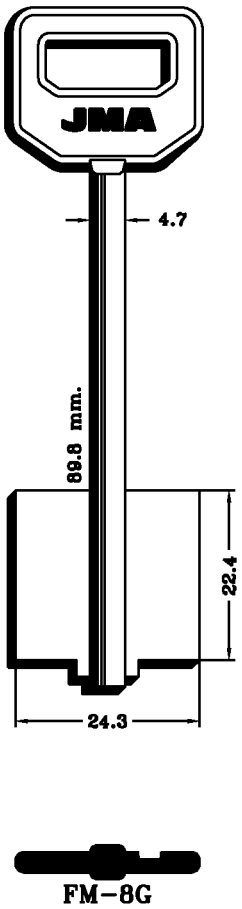

Copyright by  
Alejandro Altuna S.A.  
2005

# JMA

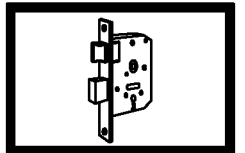

# 269

**PARA-FOR:**











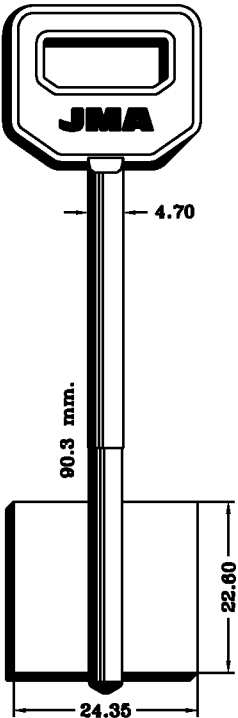

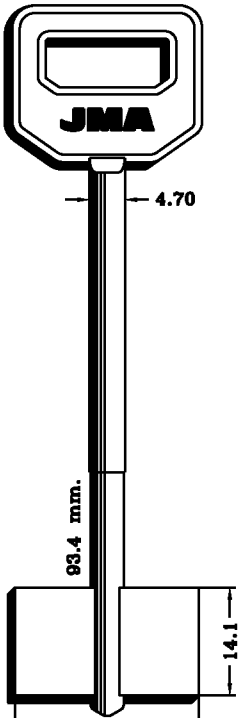

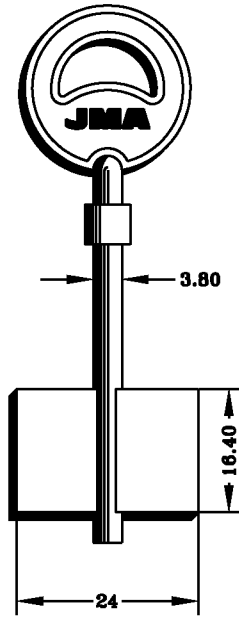

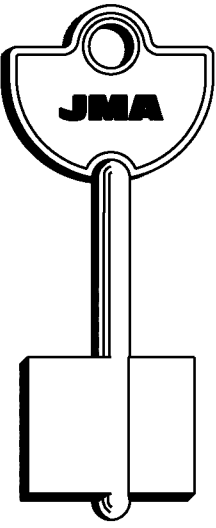
**FIAM (I)**

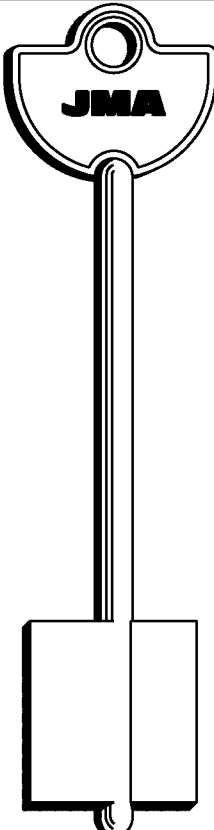
**FICHET (F)**

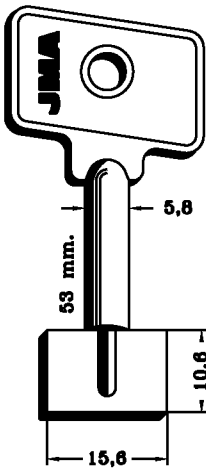
**GIPIS (I)**

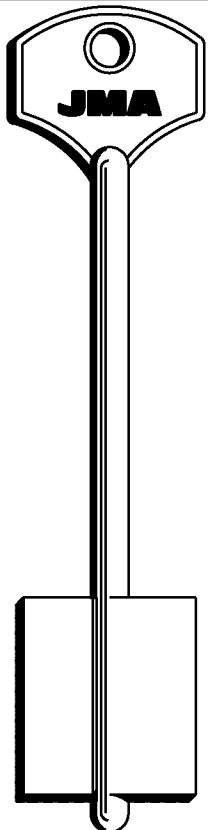
**GMG (I)**

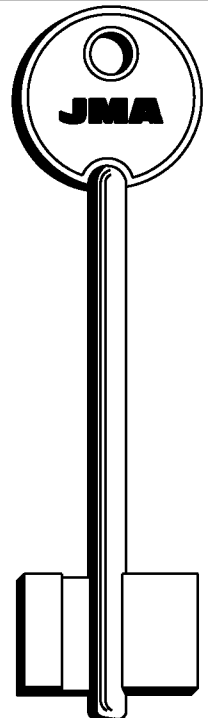
**IDM (I)**

PARA: FOR:	FIAM	FICHET	GIPIS	
	 <p>4.70 90.3 mm. 24.35 22.60</p>  <p>FM-16G</p>	 <p>4.70 93.4 mm. 24.30 14.1</p>  <p>FM-17G</p>	 <p>3.80 18.40 24</p>  <p>FIC-200</p>	  <p>GPS-1G</p>
PARA: FOR:	GIPIS	GMG	IDM	
	  <p>GPS-2G</p>	 <p>5.8 53 mm. 10.6 15.6</p>  <p>GMG-1G</p>	  <p>GMG-2G</p>	  <p>IDM-1G</p>

Copyright by  
Alejandro Altuna S.A.  
2005

**JMA**

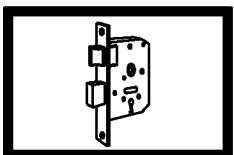

**270**

PARA:  
FOR:

### IDM

PARA-FOR:

IDM (I)

ISEO (I)

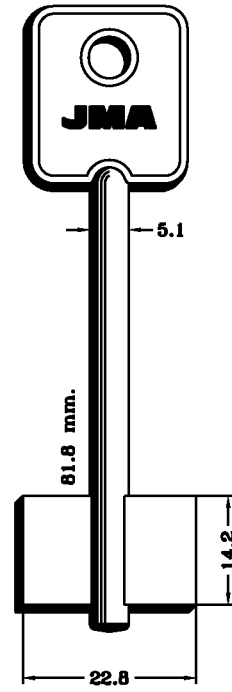
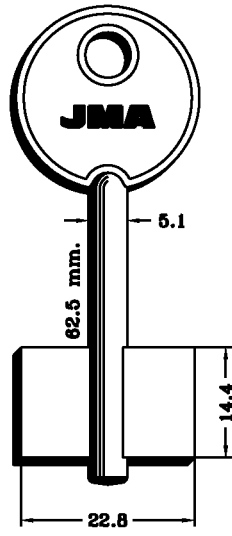
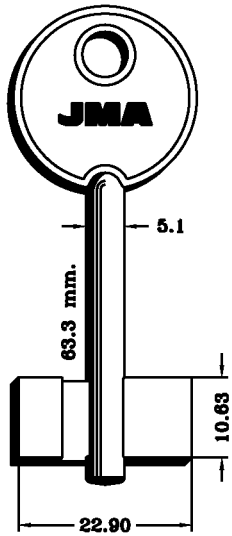
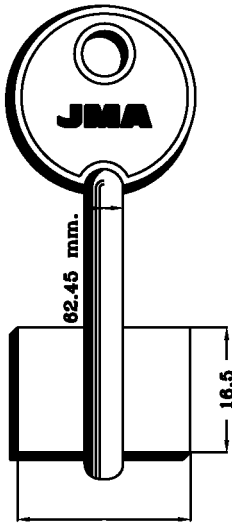

IDM-2G



IDM-3G



IDM-4G



IDM-5G

FACEF-DOMUS

PARA:  
FOR:

### ISEO

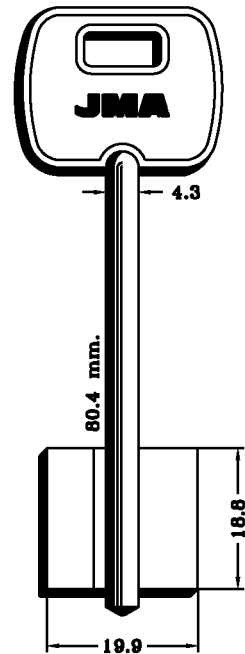
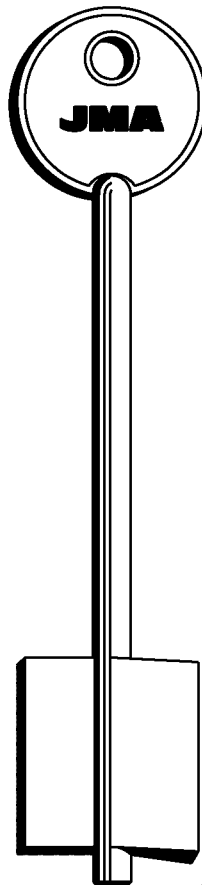
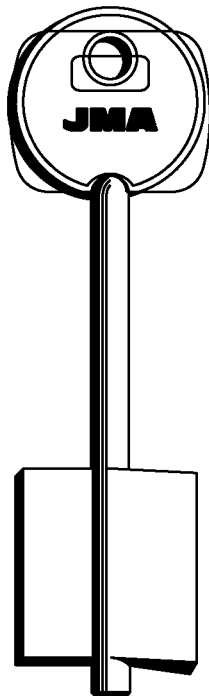
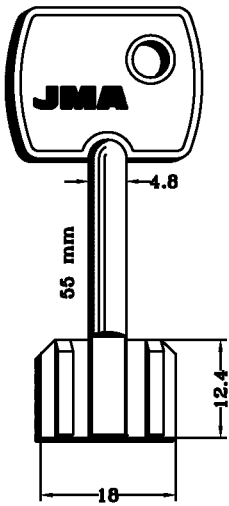

IS-1G



IS-2G



IS-3G



IS-4G

Copyright by  
Alejandro Altuna S.A.  
2005

# JMA

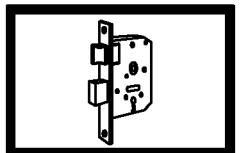

# 271

**PARA-FOR:**

PARA: ISEO  
FOR:

ITAL

ISEO (I)

ITAL (I)

JUWEL (I)

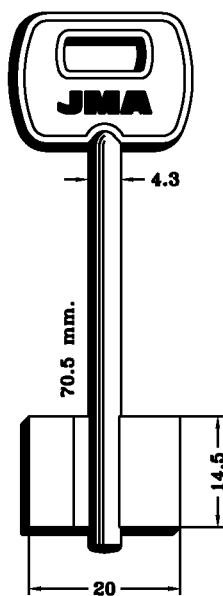

IS-5G

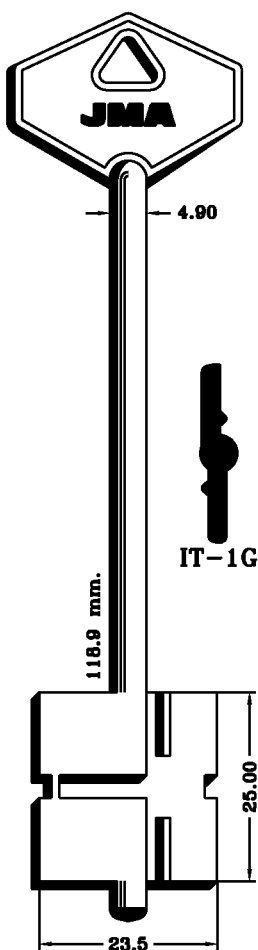

IT-1G

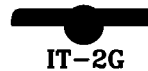
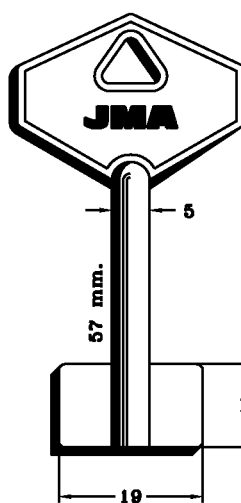
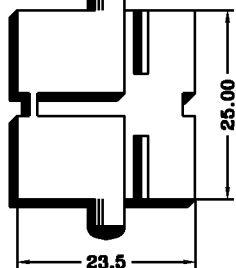

IT-2G

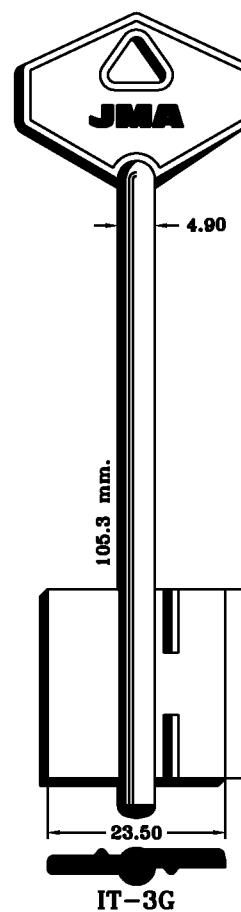

IT-3G

PARA:  
FOR:

JUWEL

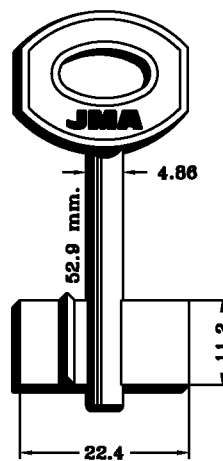

JW-20G

BURG-WACHTER

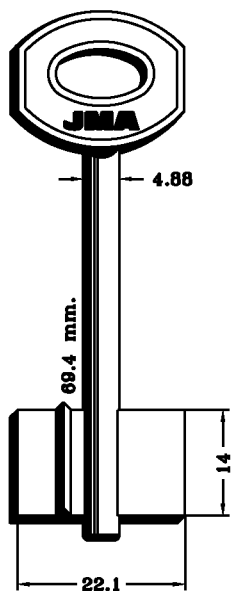

JW-30G

BURG-WACHTER

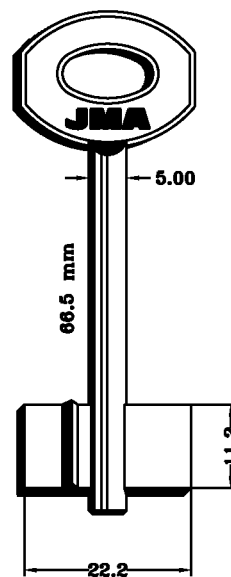

JW-40G

BURG-WACHTER

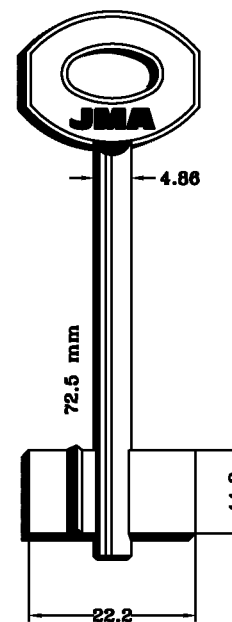

JW-45G

BURG-WACHTER

Copyright by  
Alejandro Altuna S.A.  
2005

**JMA**

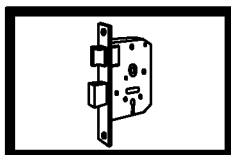

**272**

PARA:  
FOR:

**JUWEL**

**KASSEL**

**PARA-FOR:**

**JUWEL (I)**

**KASSEL (I)**

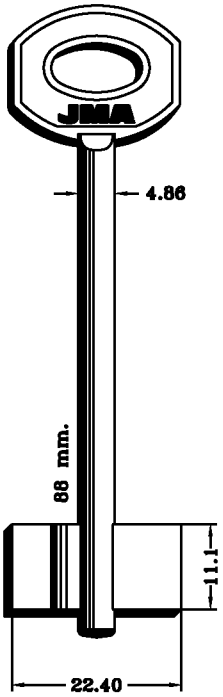

**JW-50G**

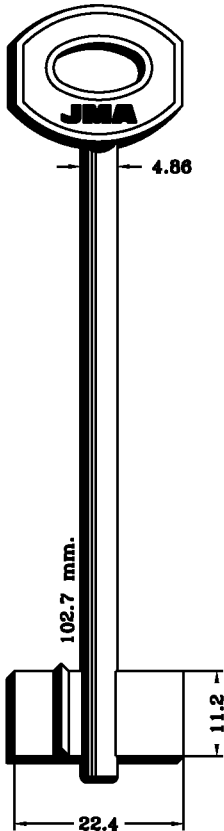

**JW-70G**

**BURG-WACHTER**

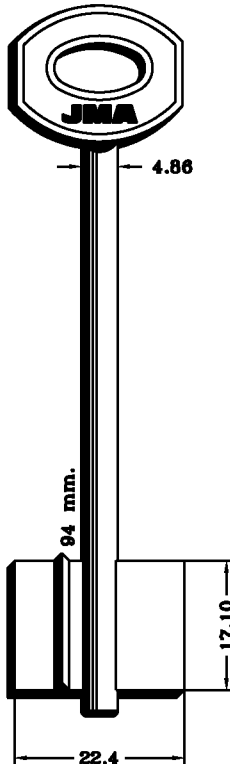

**JW-90G**

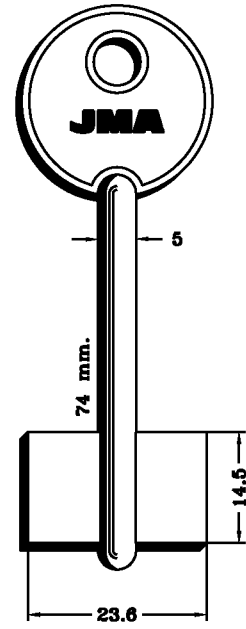

**KAS-1G**

PARA:  
FOR:

**KASSEL**

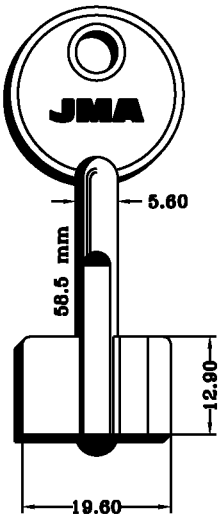

**KAS-2G**

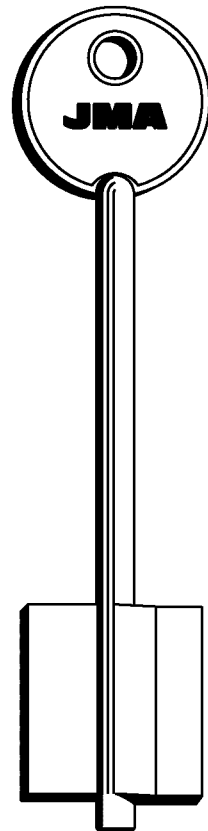

**KAS-3G**

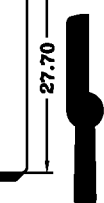
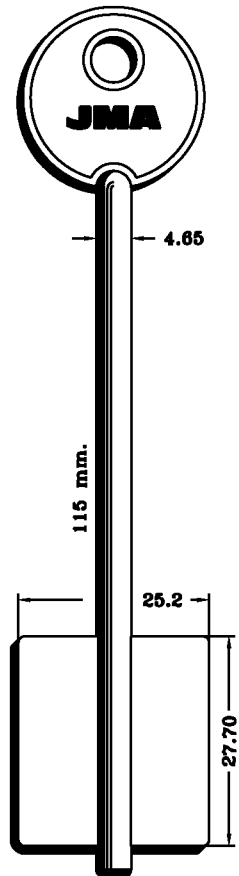

**KAS-4G**

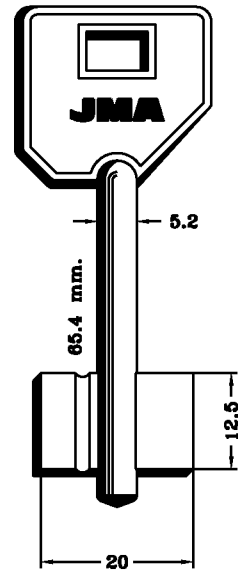

**KAS-6G**

Copyright by  
Alejandro Altuna S.A.  
2005

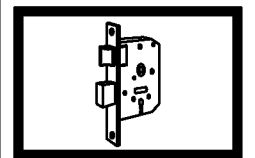

**273**

ATENCION:Concerniente a las marcas y denominaciones comerciales ver nota en indice.ATTENTION:Concerning the marks and commercial denominations see note in index.  
ATTENTION:Concernant les marques et denominations commerciales voir la note dans l'index.ACHTUNG:Beziehen auf die marke und handelsname sehen sie die notiz im index.

**PARA-FOR:**

**PARA:  
FOR:**

**KERBEROS**

**KERBEROS  
(RUS)**

**KREPISH  
(RUS)**

**KURZEME  
(RUS)**

**LINCE (E)**

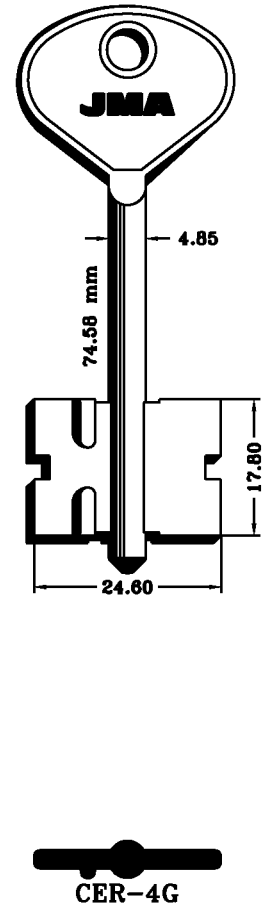
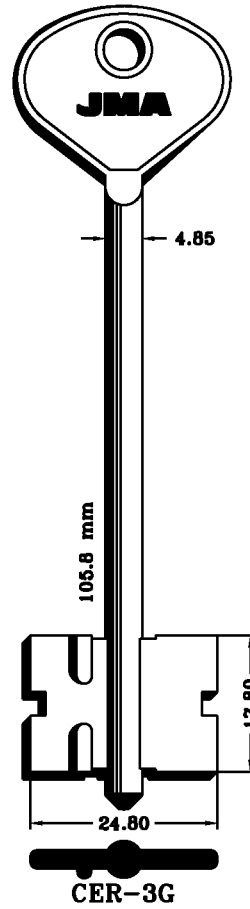
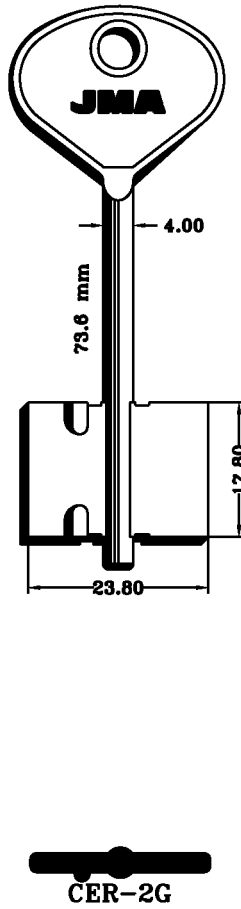
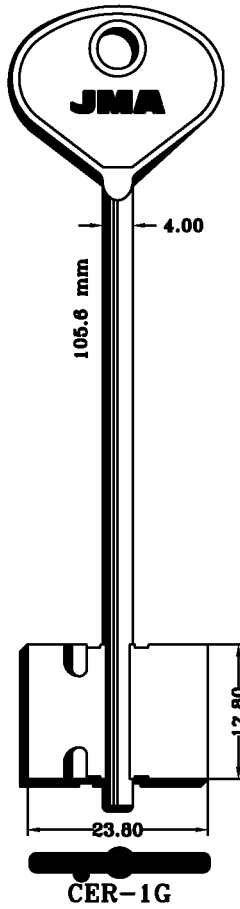

**PARA:  
FOR:**

**KREPISH**

**KURZEME**

**LINCE**

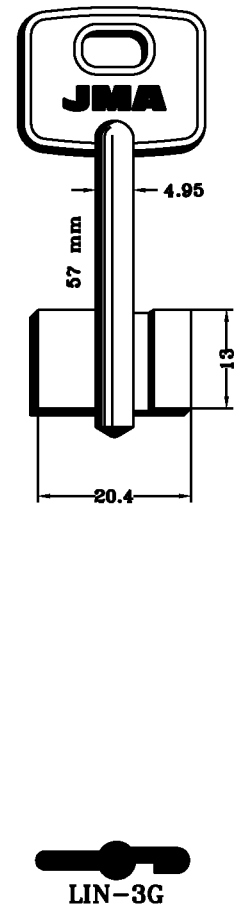
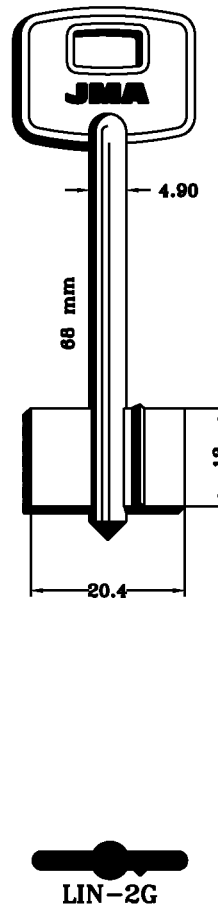
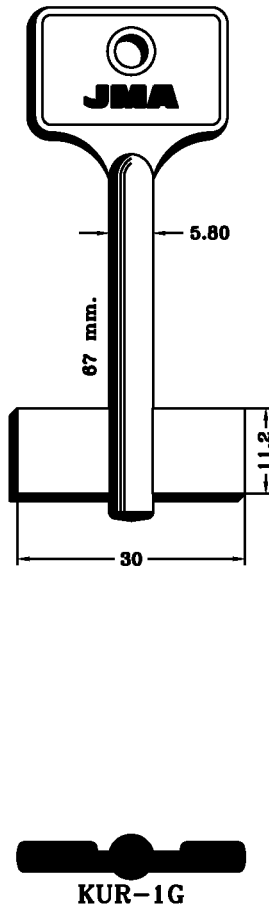
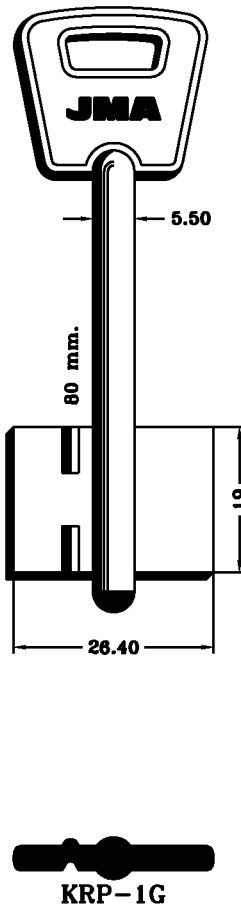

Copyright by  
Alejandro Altuna S.A.  
2005

**JMA**

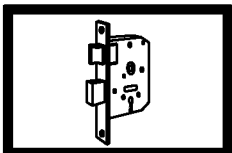

**274**

PARA:  
FOR:

MCM

MOIA

PARA-FOR:

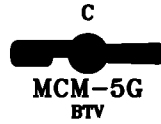
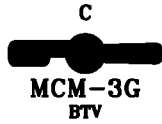
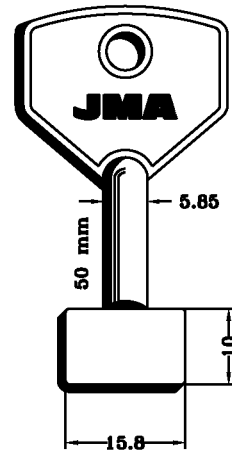
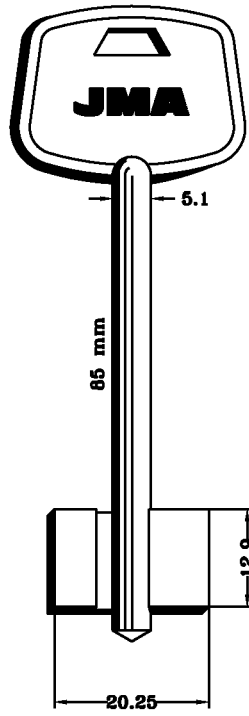
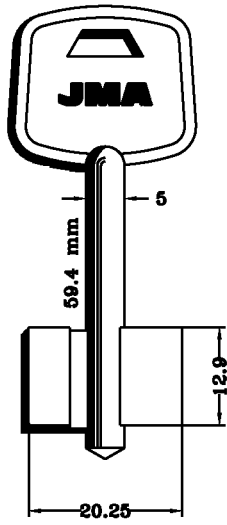
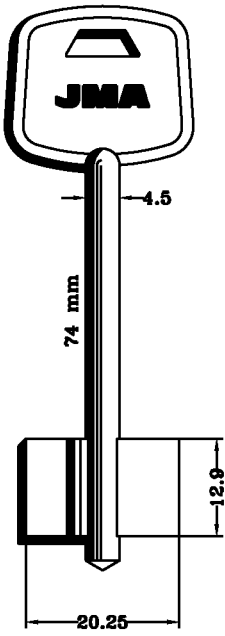

MCM (E)

MOIA (I)

MOTTURA (I)

PARA:  
FOR:

MOIA

MOTTURA

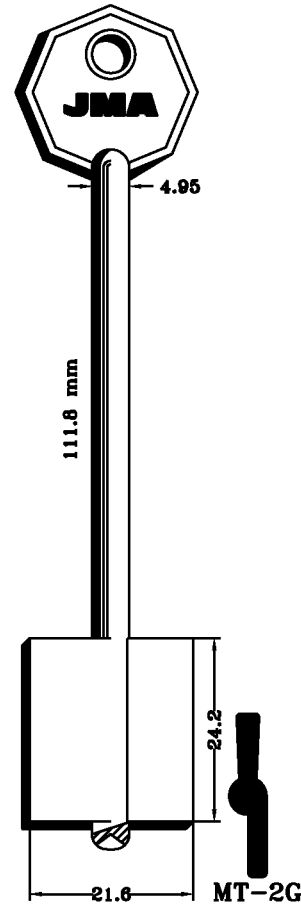
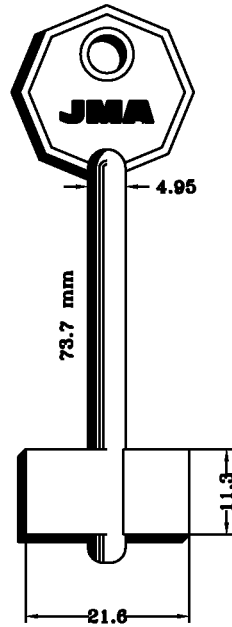
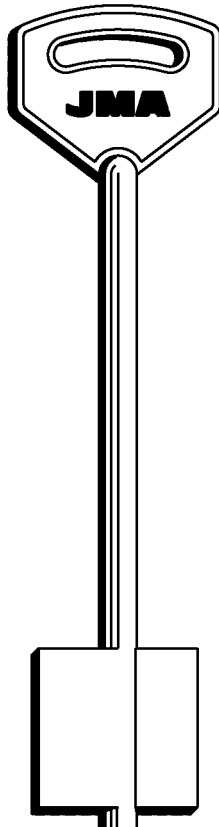
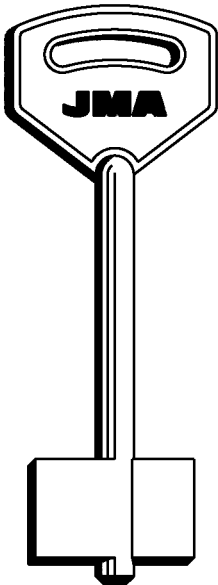

Copyright by  
Alejandro Altuna S.A.  
2005

JMA

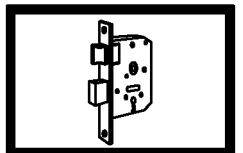

275

**PARA-FOR:**

**PARA:  
FOR:**

**MOTTURA**

**MOTTURA (I)**

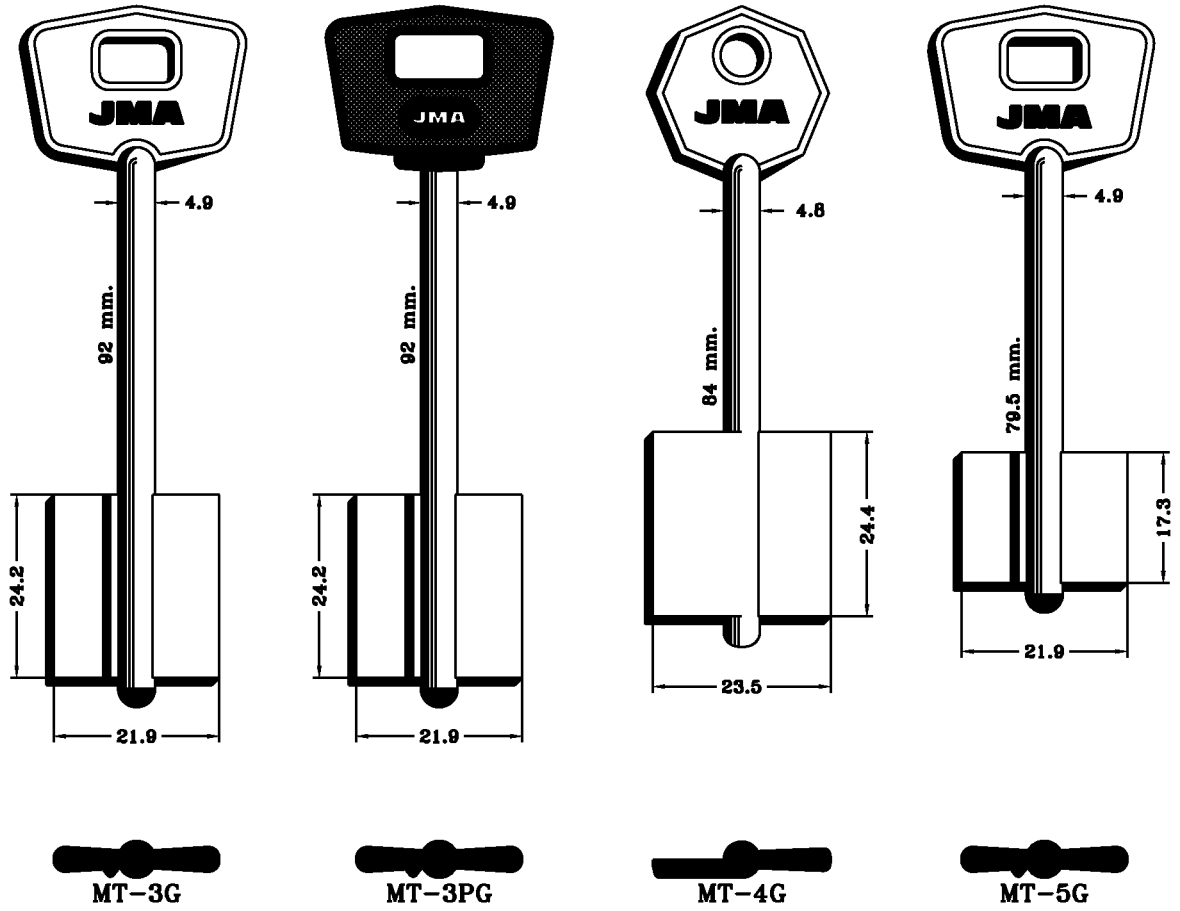

**PARA:  
FOR:**

**MOTTURA**

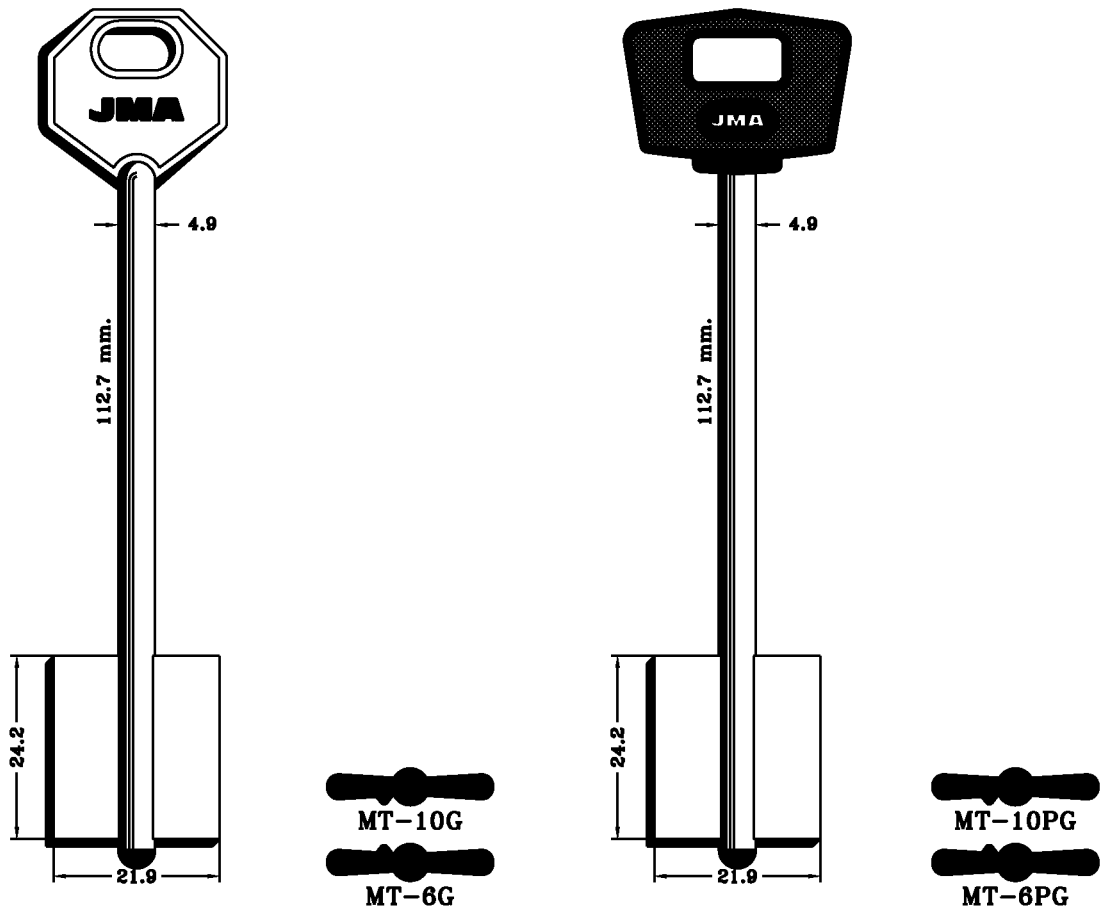

Copyright by  
Alejandro Altuna S.A.  
2005

**JMA**

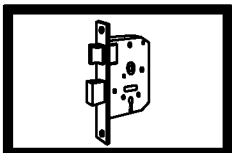

**276**

PARA:  
FOR:

### MOTTURA

PARA-FOR:

MOTTURA (I)

OMECA (I)

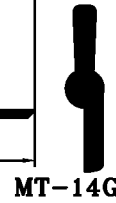
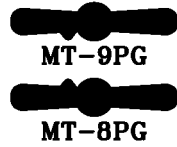
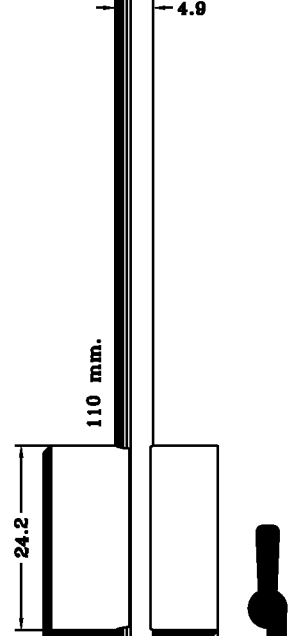
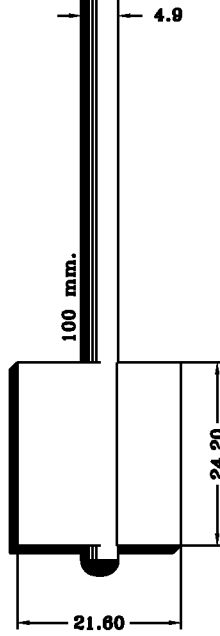
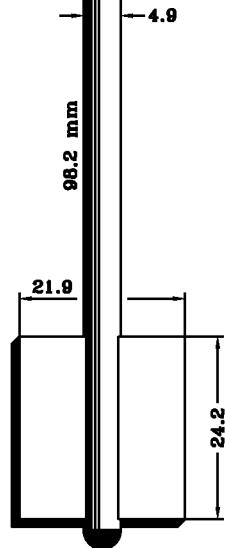
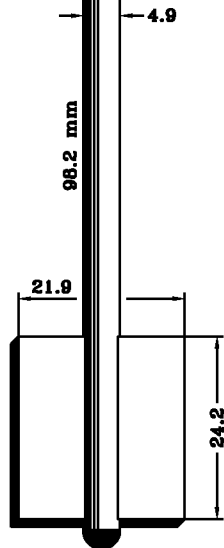
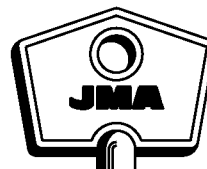
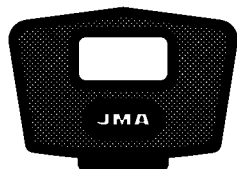

PARA:  
FOR:

### MOTTURA

### OMECA

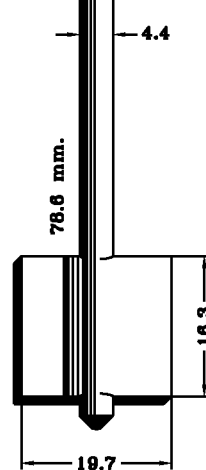
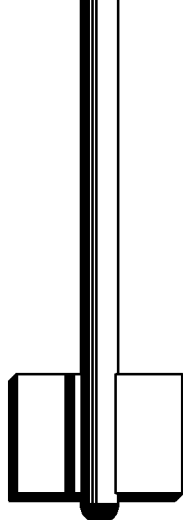
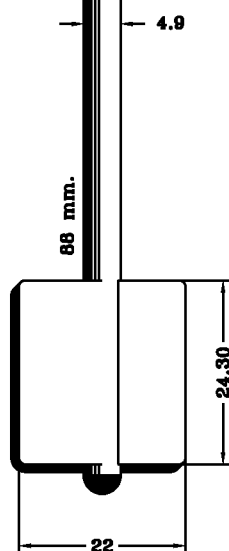
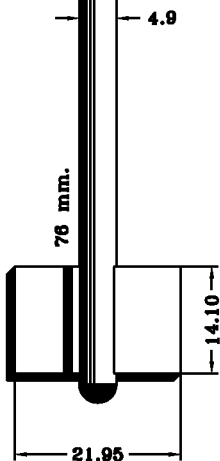
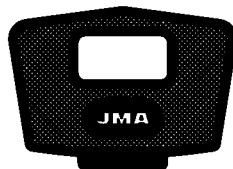
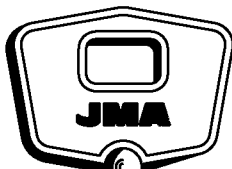
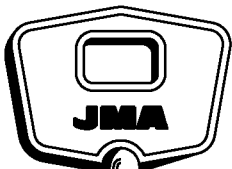

Copyright by  
Alejandro Altuna S.A.  
2005

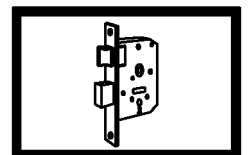

277

**PARA-FOR:**

ORENGO

PATRONE

POTENT

**ORENGO (E)**

**PATRONE (I)**

**POTENT (I)**

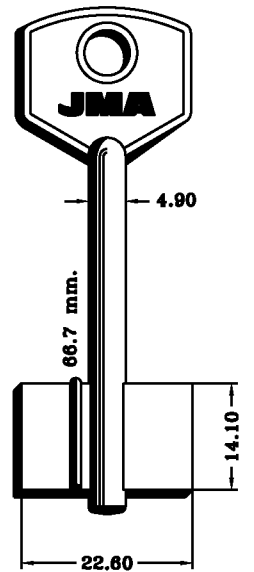
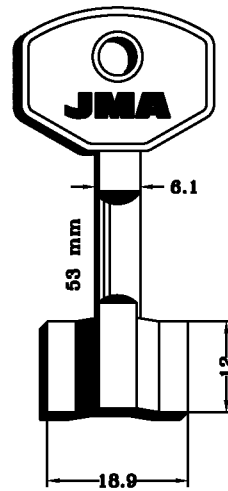
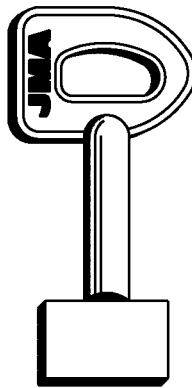
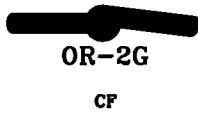
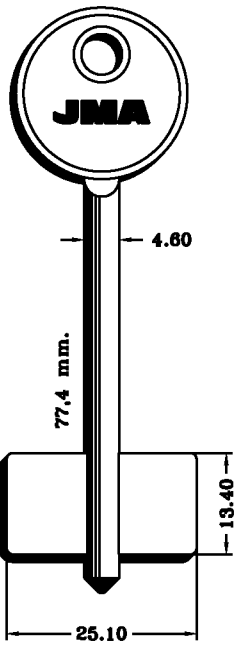

PARA:  
FOR:

POTENT

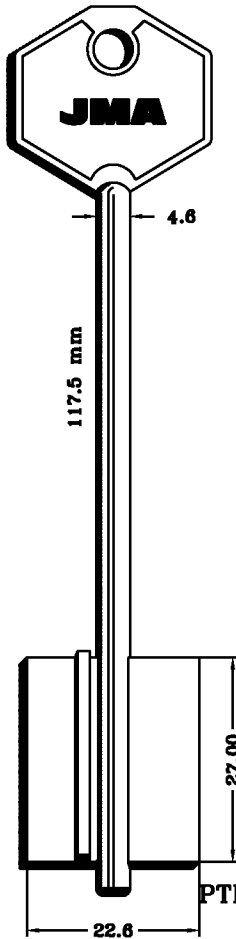
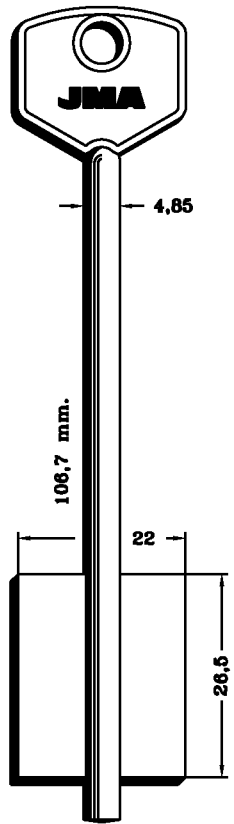

PTN-4G

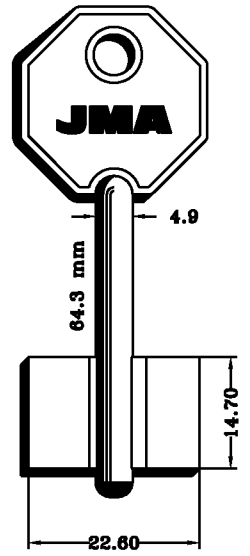
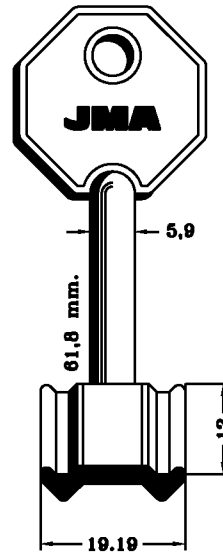

PTN-6G

Copyright by  
Alejandro Altuna S.A.  
2005

**JMA**

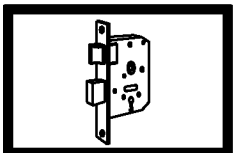

**278**

PARA:  
FOR:

### POTENT

PARA-FOR:

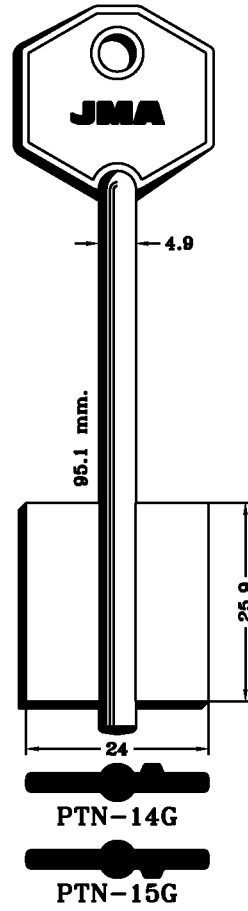
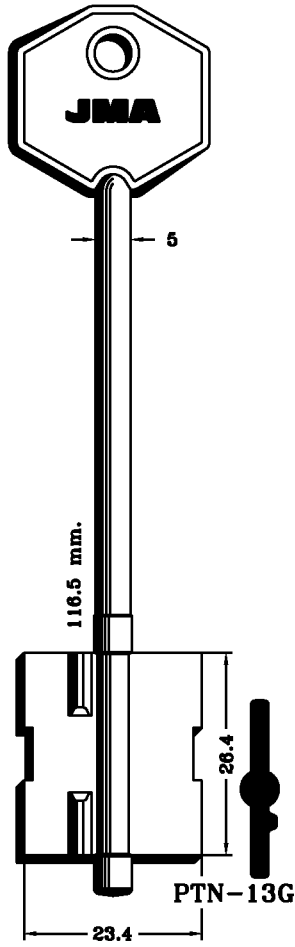
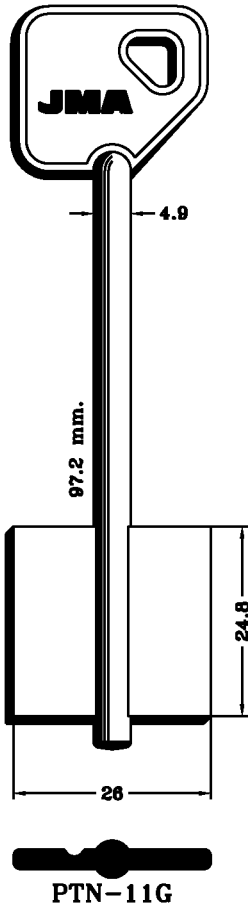
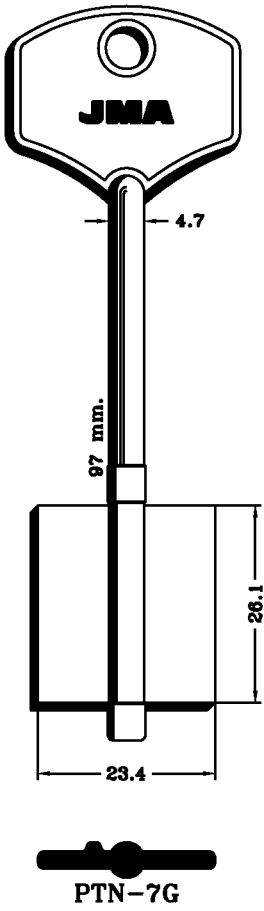

POTENT (I)  
PREFER (I)  
REVI (E)

PARA:  
FOR:

### PREFER

### REVI

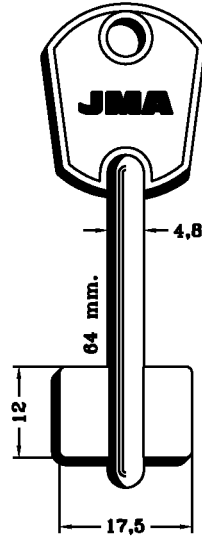
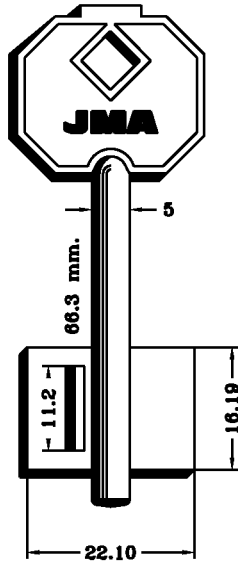
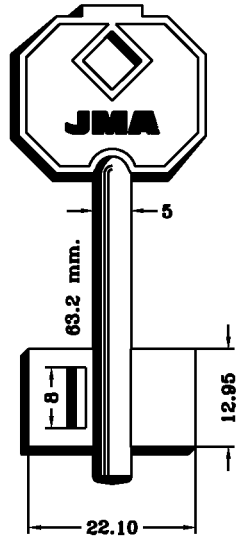
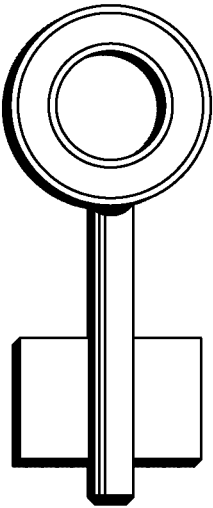

Copyright by  
Alejandro Altuna S.A.  
2005

JMA

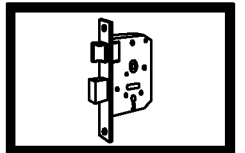

279

**PARA-FOR:**

**RIGAL (RUS)**

**RUBEN (RUS)**

**SAFE (I)**

**SAM (RUS)**

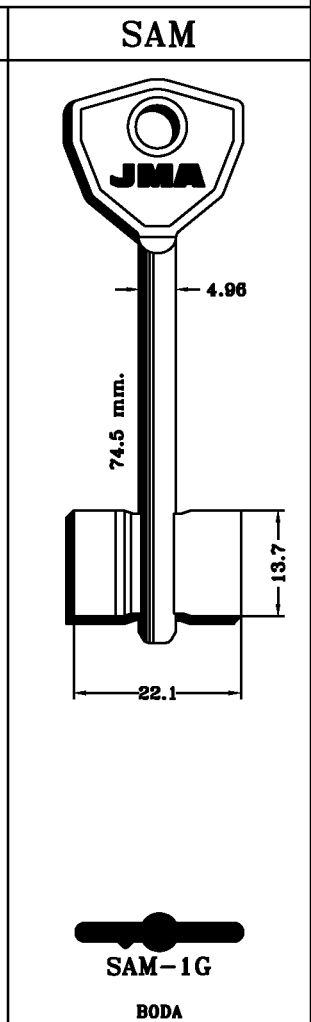
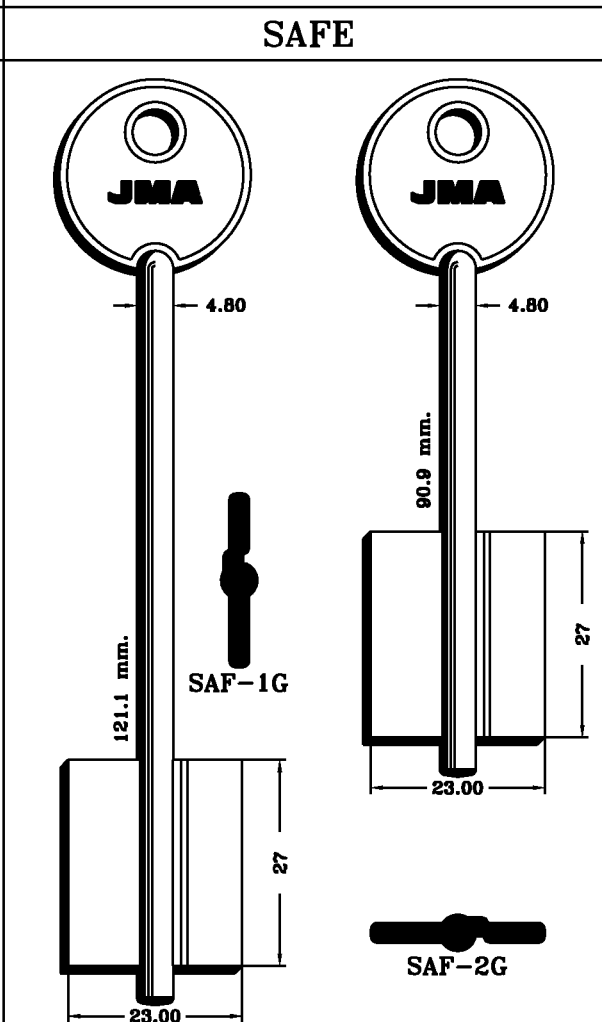
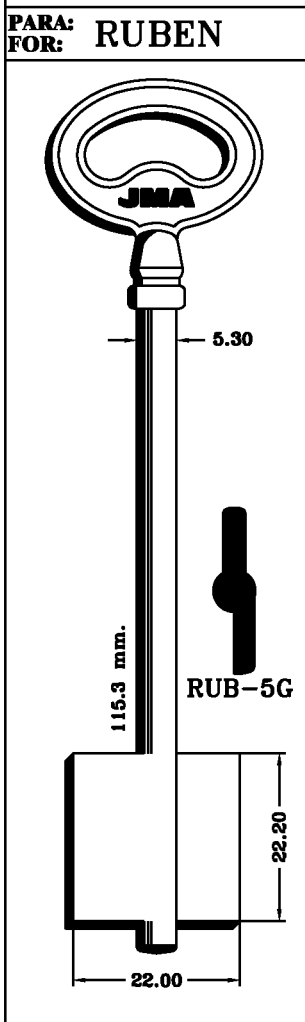
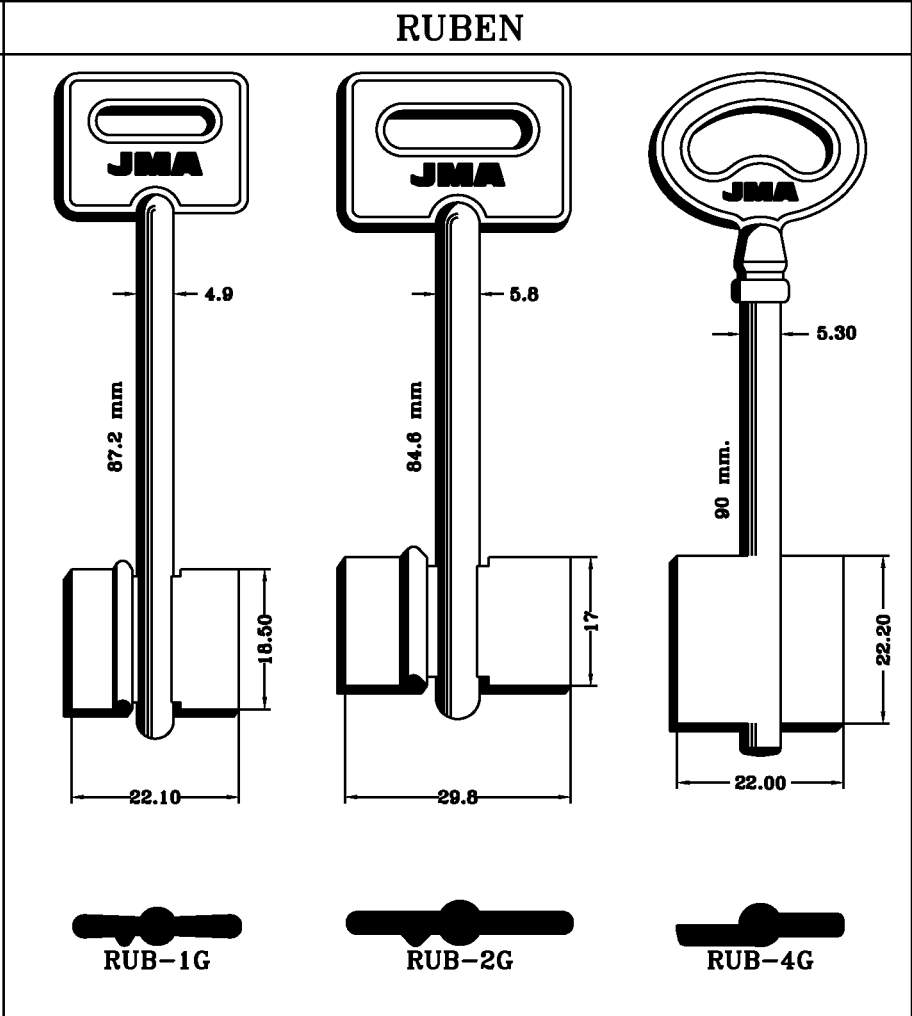
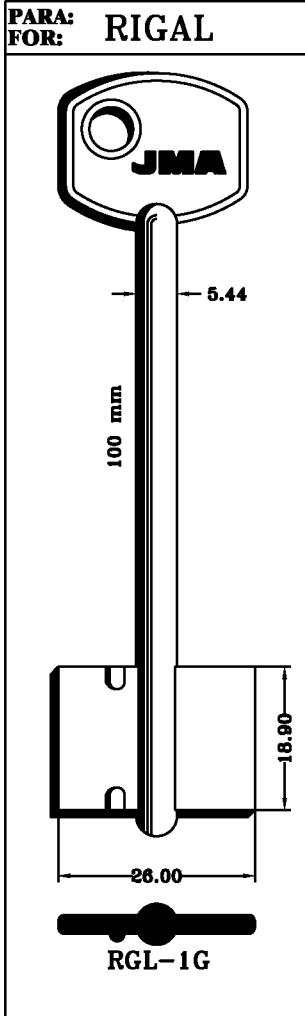



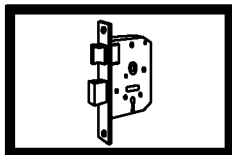

Copyright by  
Alejandro Altuna S.A.  
2005

**JMA**

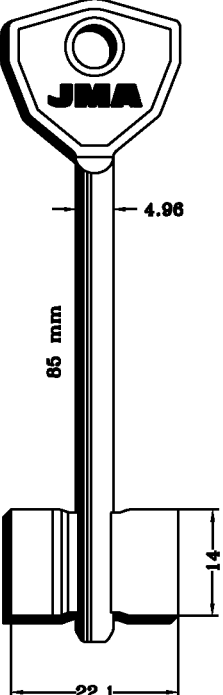
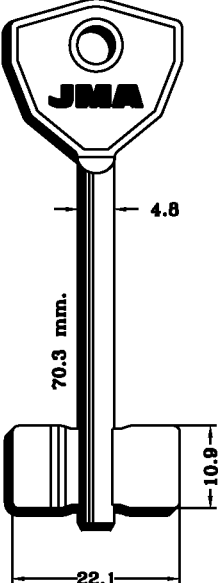
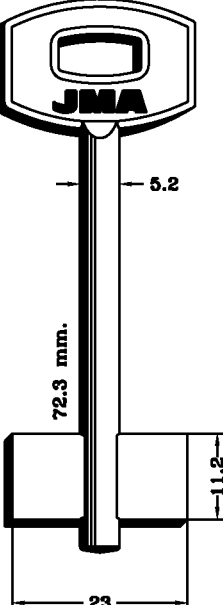
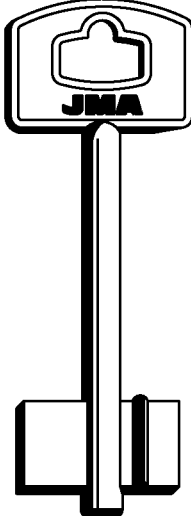

**280**





PARA: FOR:		SAM	SECUREMME
			
4.96	4.8	5.2	
65 mm	70.3 mm.	72.3 mm.	
14	10.9	11.2	
22.1	22.1	23	
			
SAM-2G	SAM-4G	SEC-1G	SEC-2G
BODA	BODA		

**PARA-FOR:**

**SAM (RUS)**

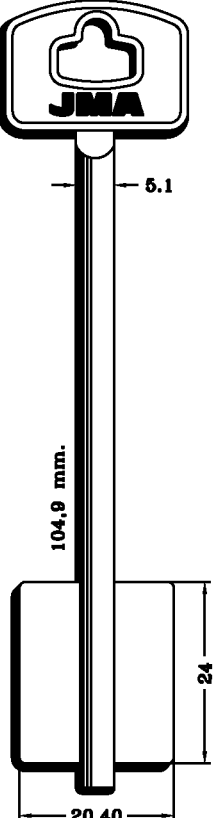
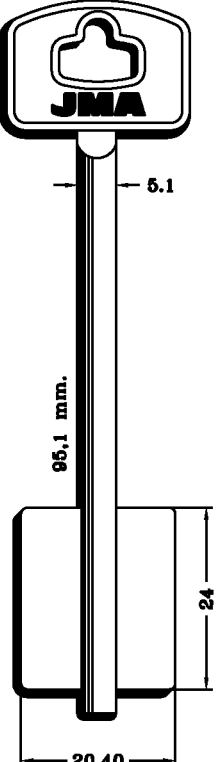
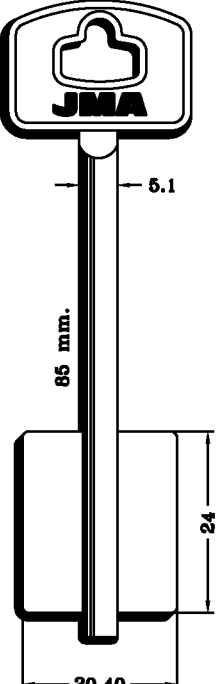
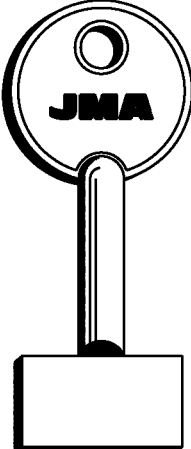
**SECUREMME  
(I)**

**SERMEC (I)**

PARA: FOR:		SECUREMME	SERMEC
			
5.1	5.1	5.1	
104.9 mm.	95.1 mm.	65 mm.	
24	24	24	
20.40	20.40	20.40	
			
SEC-3G	SEC-4G	SEC-7G	SRM-1G

Copyright by  
Alejandro Altuna S.A.  
2005

**JMA**

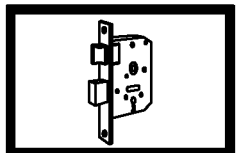

**281**

**PARA-FOR:**

**PARA:  
FOR:**

**SIBI**

**SIBI (I)**

**SIDERAL (I)**

**TECSESA (E)**

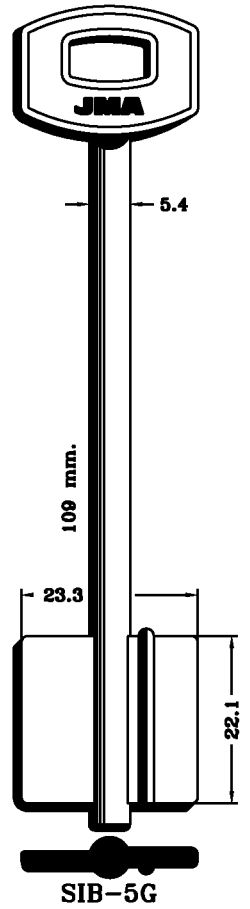
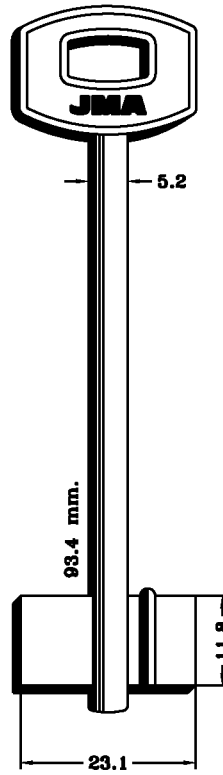
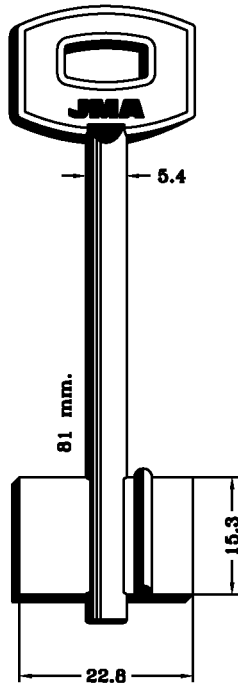
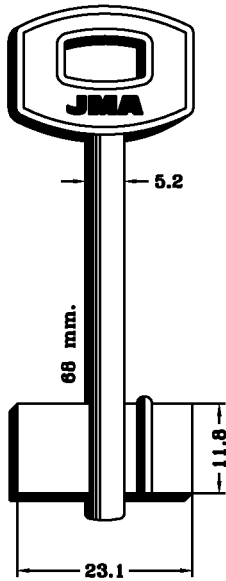

**PARA:  
FOR:**

**SIDERAL**

**TECSESA**

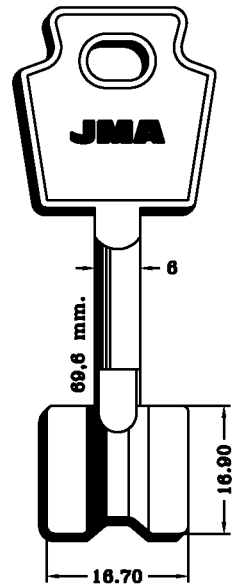
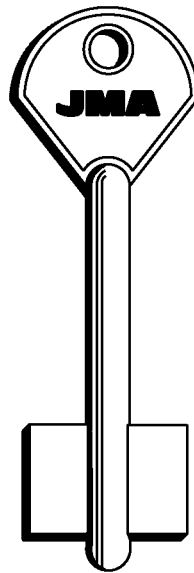
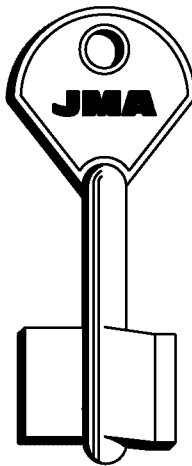
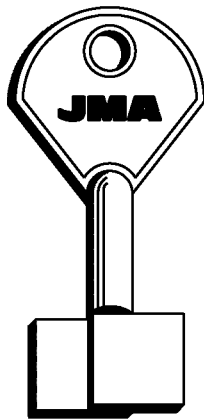

Copyright by  
Alejandro Altuna S.A.  
2005

**JMA**

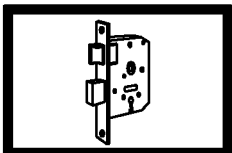

**282**

**ATENCION:**Concerniente a las marcas y denominaciones comerciales ver nota en indice.**ATTENTION:**Concerning the marks and commercial denominations see note in Index.  
**ATTENTION:**Concernant les marques et denominations commerciales voir la note dans l'Index.**ACHTUNG:**Beziehen auf die marke und handelsname sehen sie die notiz im Index.

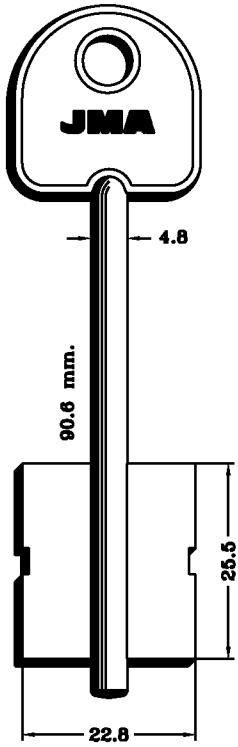
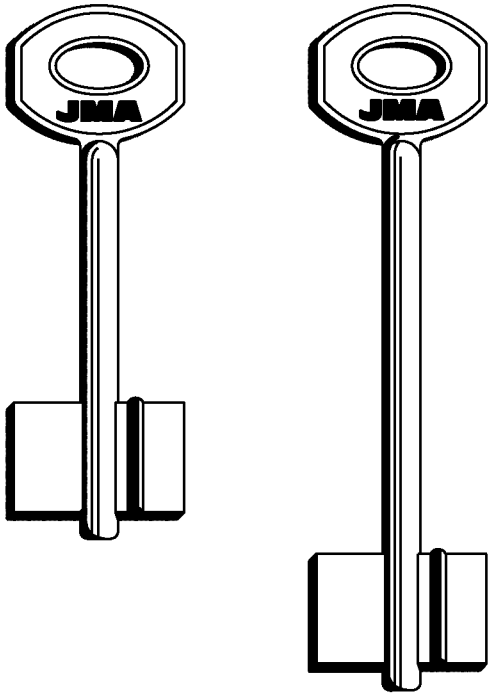
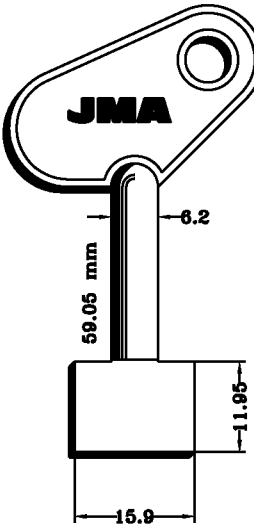
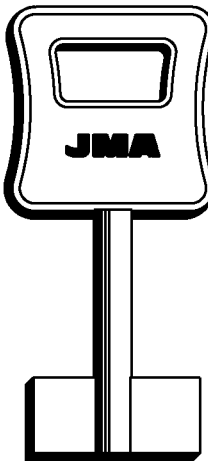
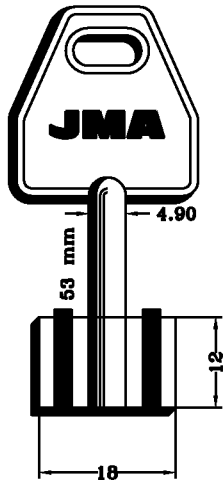
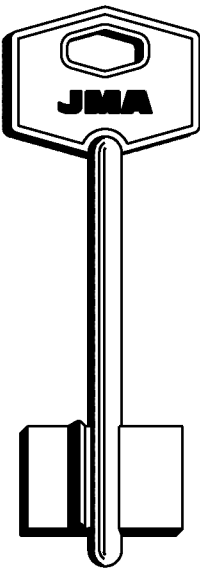
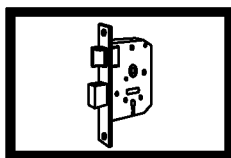
PARA: FOR:	TESIO	TITANO		TOVER	<b>PARA-FOR:</b>
	 <p>4.8</p> <p>90.6 mm.</p> <p>25.5</p> <p>22.8</p> <p><b>JMA</b></p> <p>TSI-1G</p>	 <p><b>JMA</b></p> <p><b>JMA</b></p> <p>TTN-1G</p> <p>TTN-2G</p>	 <p>6.2</p> <p>59.05 mm</p> <p>11.95</p> <p>15.9</p> <p><b>JMA</b></p> <p>TOV-1G</p>	<p><b>TESIO (I)</b></p> <p><b>TITANO (I)</b></p> <p><b>TOVER (E)</b></p> <p><b>4 TR (I)</b></p> <p><b>TUSHINO (RUS)</b></p> <p><b>WELKA (I)</b></p>	
PARA: FOR:	4 TR	TUSHINO		WELKA	
	 <p>4.90</p> <p>53 mm</p> <p>18</p> <p>12</p> <p><b>JMA</b></p> <p>TR-1G</p>	 <p>4.90</p> <p>53 mm</p> <p>18</p> <p>12</p> <p><b>JMA</b></p> <p>TUS-1G</p>		 <p>4.90</p> <p>53 mm</p> <p>18</p> <p>12</p> <p><b>JMA</b></p> <p>WE-1G</p>	<p>Copyright by Alejandro Altuna S.A. 2005</p> <p><b>JMA</b></p>  <p><b>283</b></p>

**PARA-FOR:**

**PARA: FOR: WELKA**

**YALE**

**WELKA (I)**

**YALE (I)**

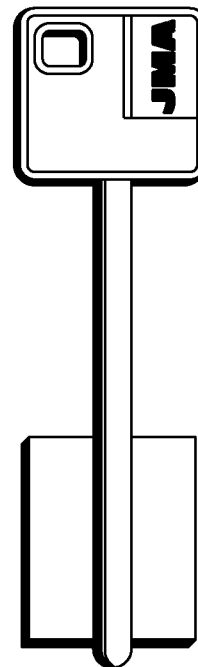
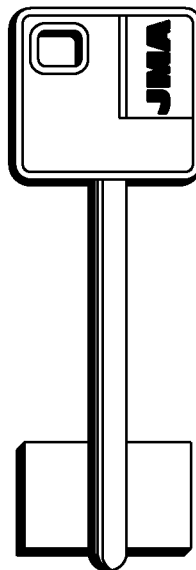
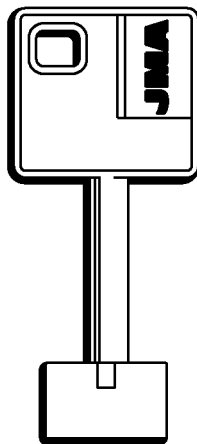
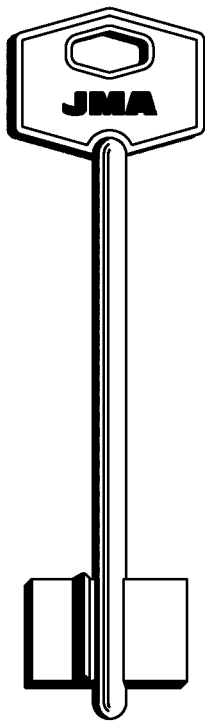

**PARA: FOR: YALE**

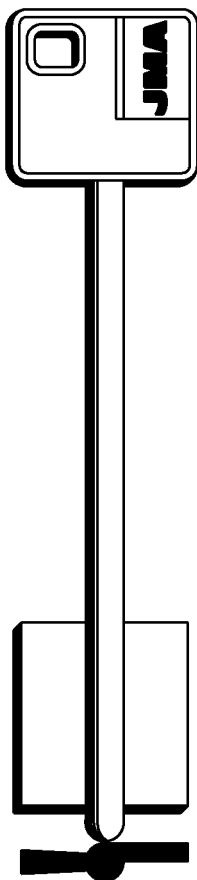

**YA-4G**

Copyright by  
Alejandro Altuna S.A.  
2005

**JMA**

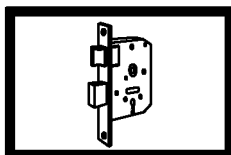

**284**

**PARA-FOR:**

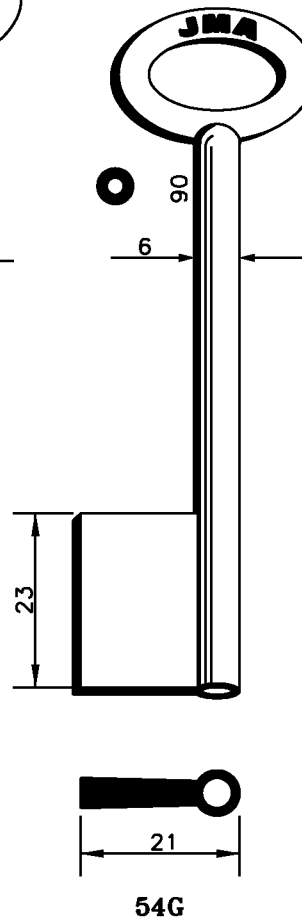
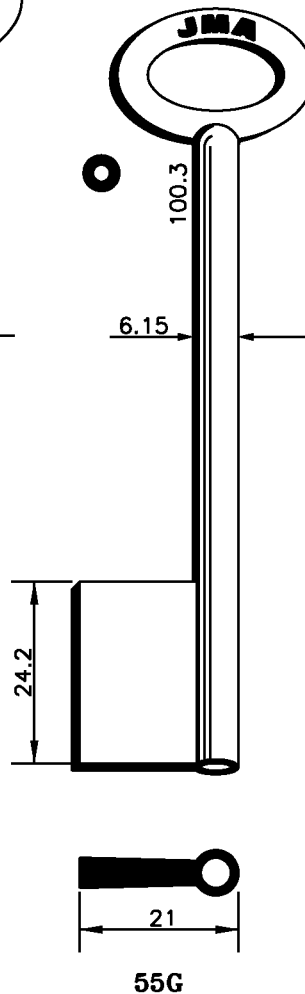
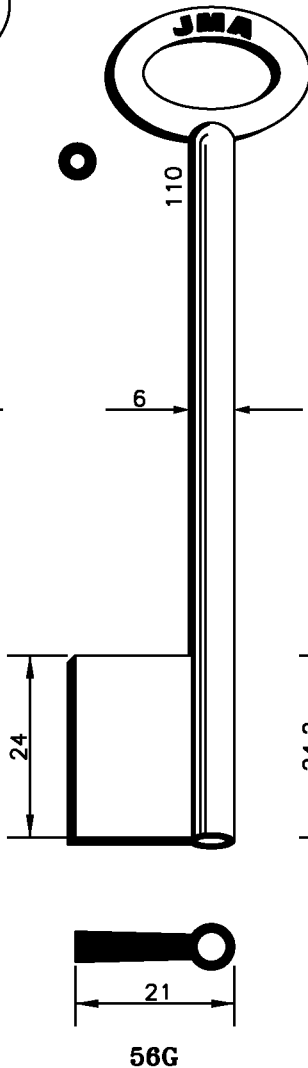
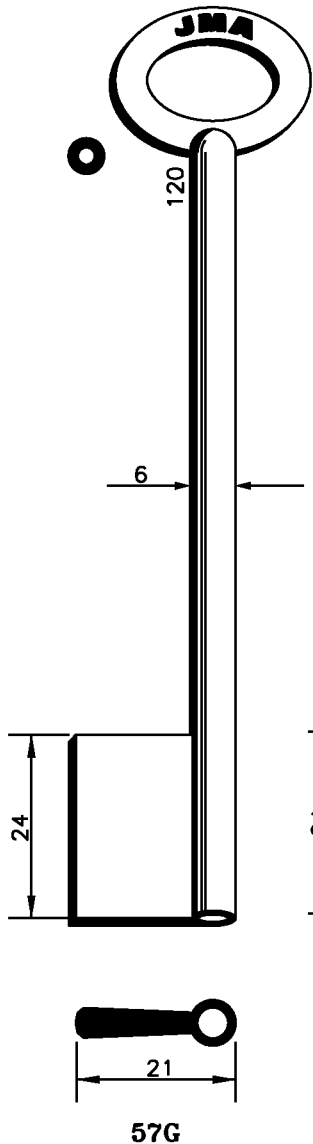
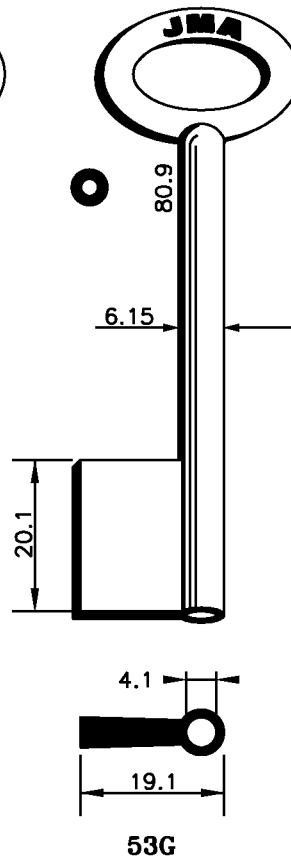
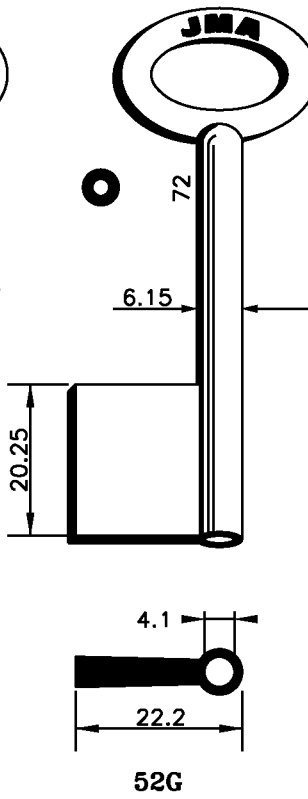
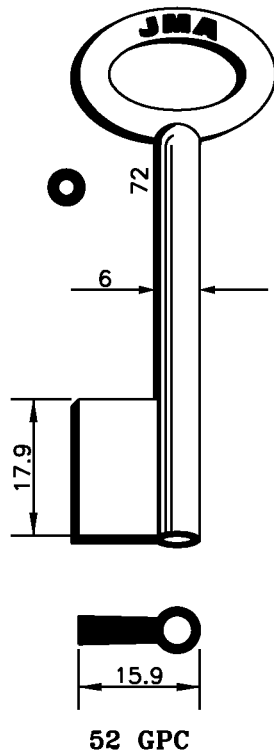
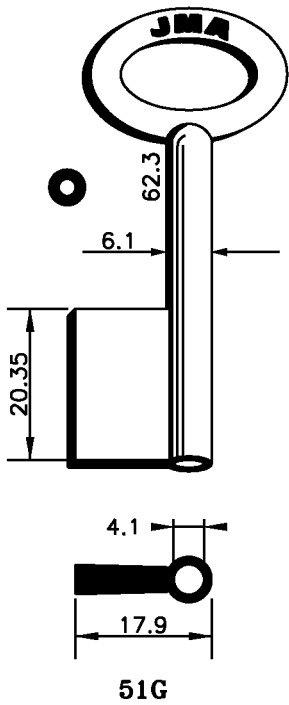

Copyright by  
Alejandro Altuna S.A.  
2005

**JMA**

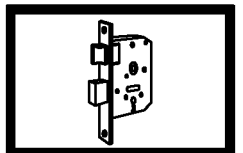

**285**

**PARA-FOR:**

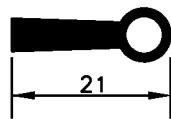
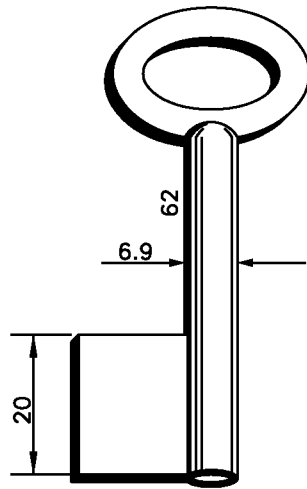

**66G**

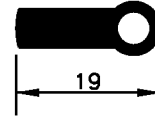
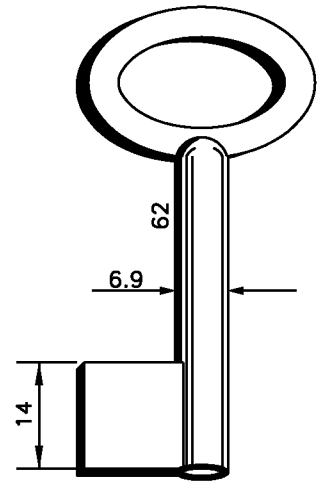

**68G**

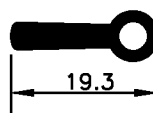
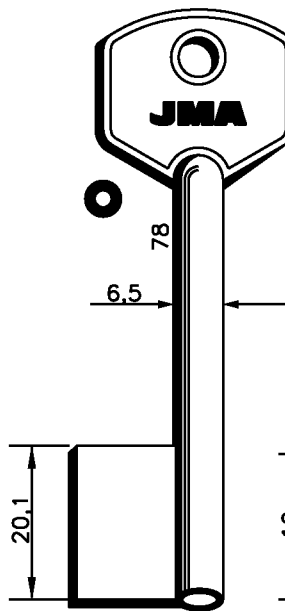

**72G**

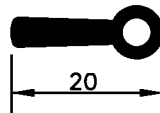
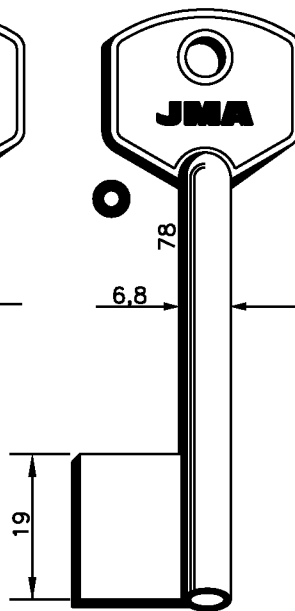

**73G**

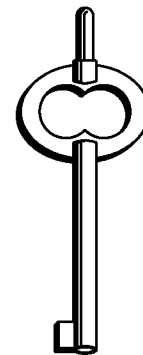

**74G**

Copyright by  
Alejandro Altuna S.A.  
2005

**JMA**

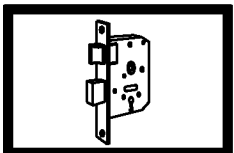

**286**

<b>PARA:</b> <b>FOR:</b>	<b>ABUS</b>	<b>AGA</b>
<p>AD-33T</p>	<p>ABU-2G</p>	<p>AGA-2G</p>

**PARA-FOR:**

- ABUS (D)**
- AGA (E)**
- ALEDAL (S)**
- ARCU (E)**

<b>PARA:</b> <b>FOR:</b>	<b>AGA</b>	<b>ALEDAL</b>	<b>ARCU</b>	
<p>AGA-3G</p> <p>AGA-5G</p>	<p>ALE-1G</p>	<p>ARC-1G</p>	<p>ARC-2G</p>	

Copyright by  
Alejandro Altuna S.A.  
2005

**JMA**

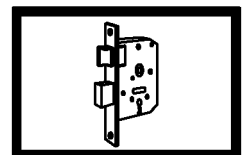

**287**

**PARA-FOR:**

PARA:  
FOR:

**ARCU**

**ARCU (E)**

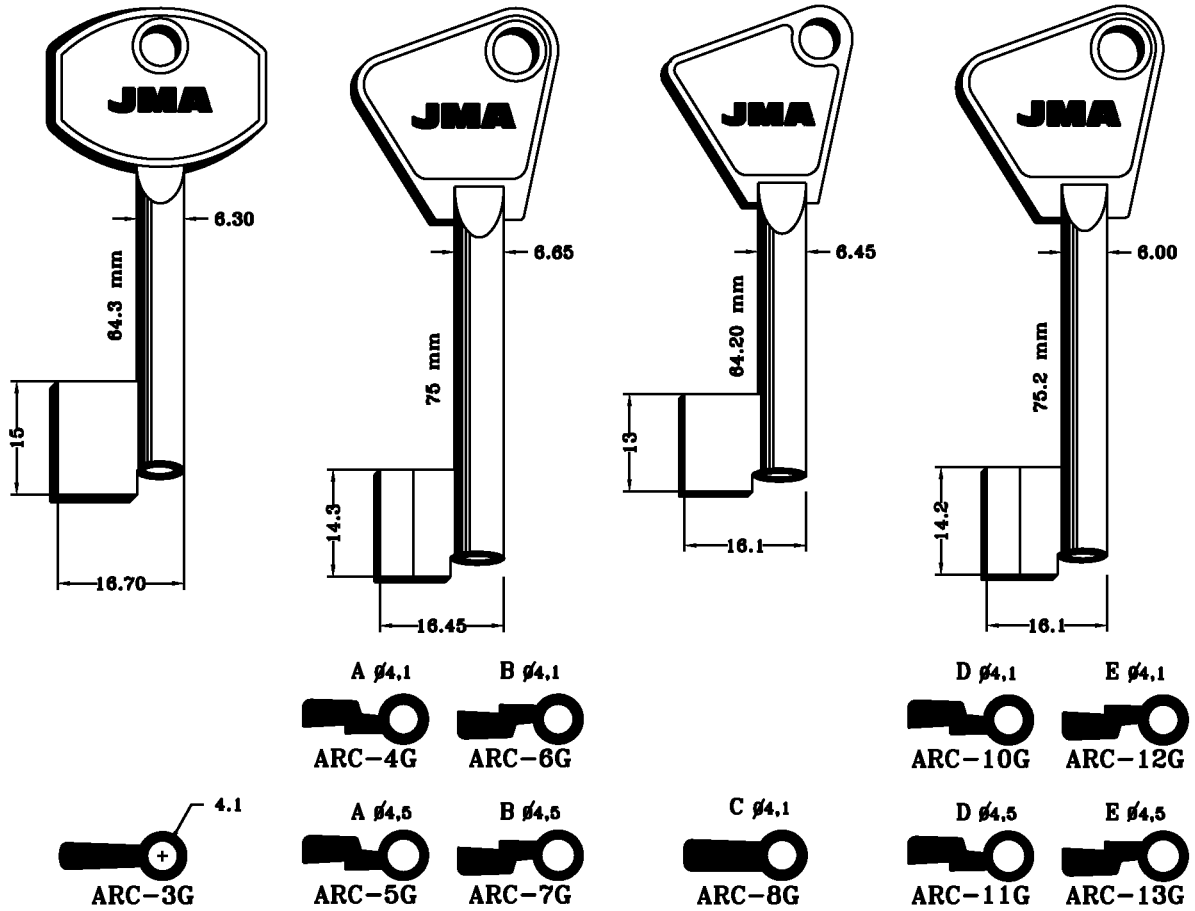

PARA:  
FOR:

**ARCU**

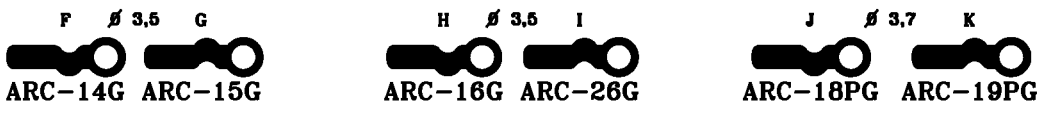
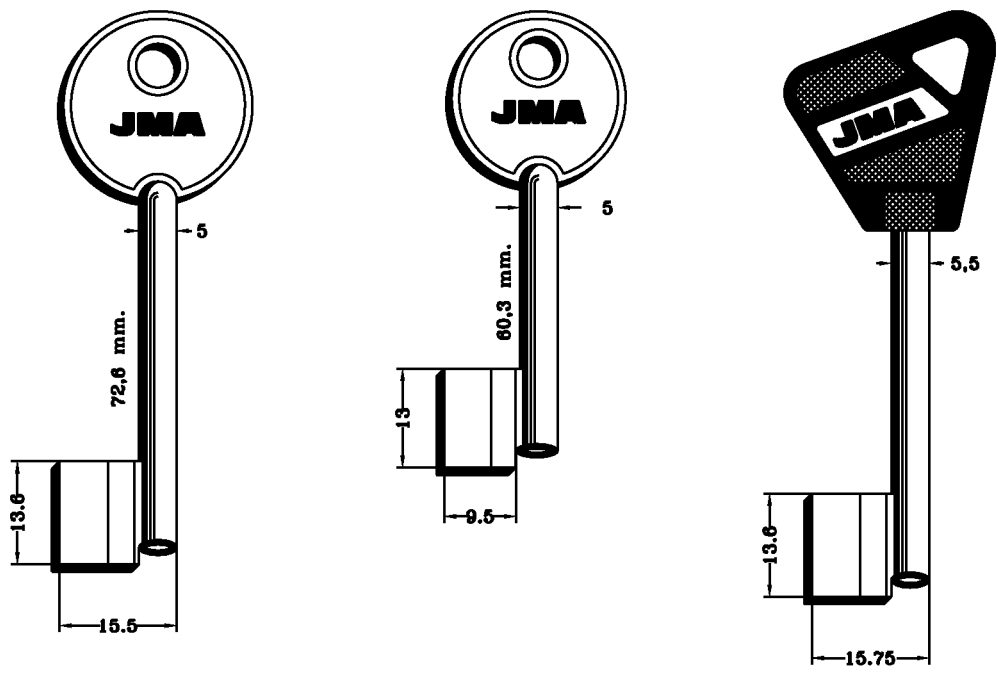

Copyright by  
Alejandro Altuna S.A.  
2005

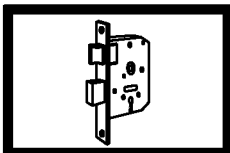

**288**

PARA:  
FOR:

ARCU

ASSA

PARA-FOR:

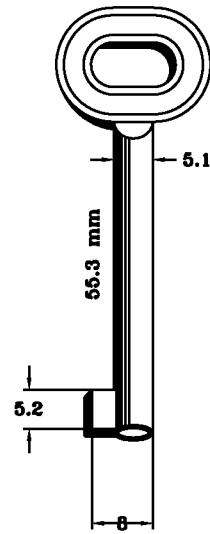
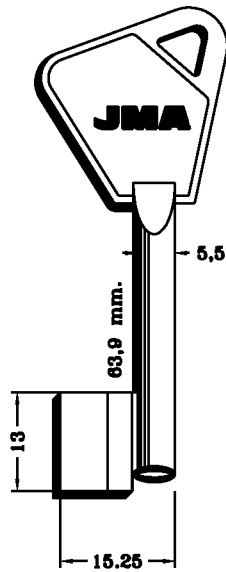
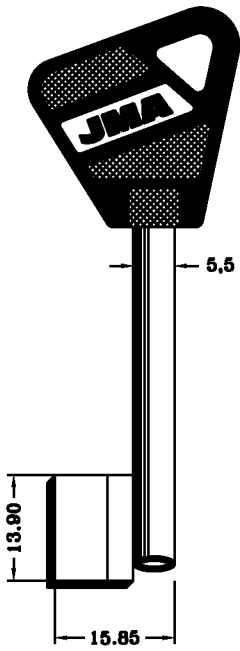

ARCU (E)

ASSA (S)

AYPE (E)

CERUTTI (I)

GEDASA (E)

LAR (E)

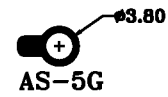

PARA:  
FOR:

AYPE

CERUTTI

GEDASA

LAR

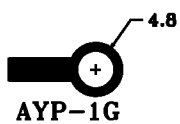
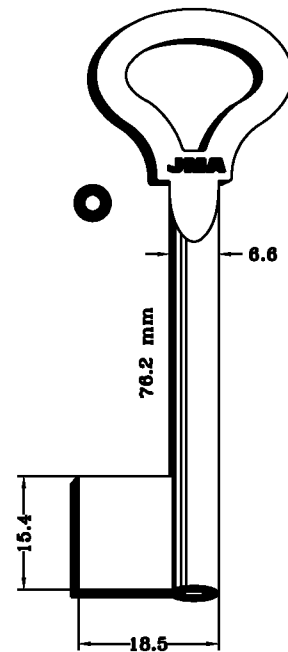
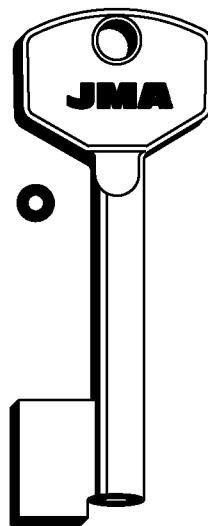
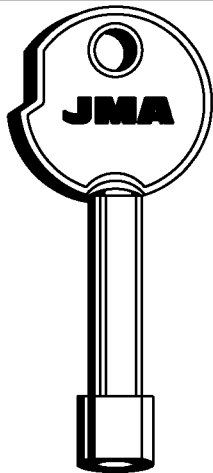
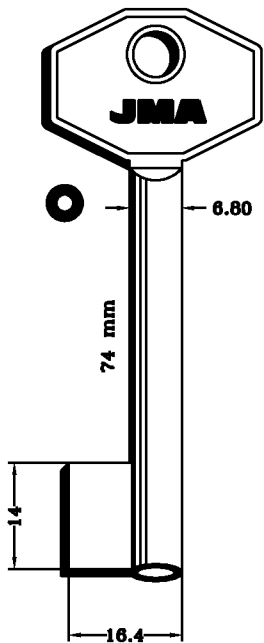

Copyright by  
Alejandro Altuna S.A.  
2005

JMA

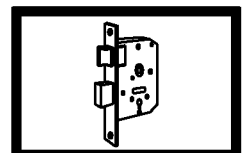

289

**PARA-FOR:**

**LAR (E)**

**ORENGO (E)**

**RUBEN (RUS)**

**RUE (F)**

**VILLFER (E)**

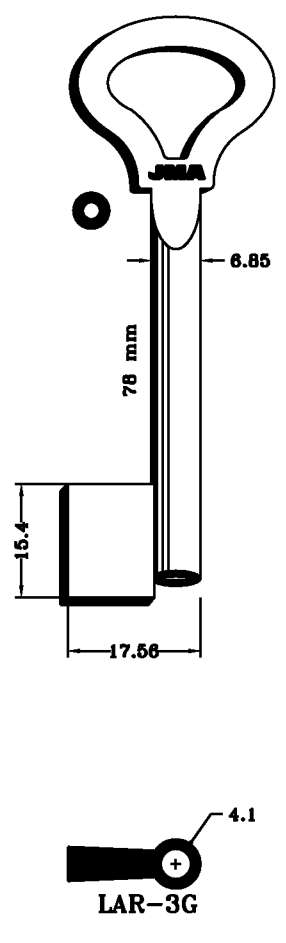
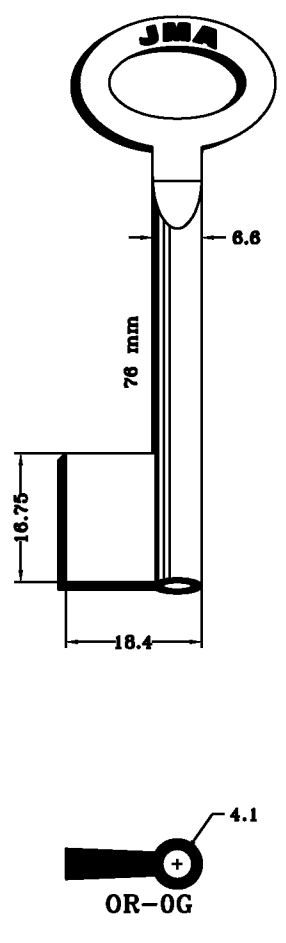
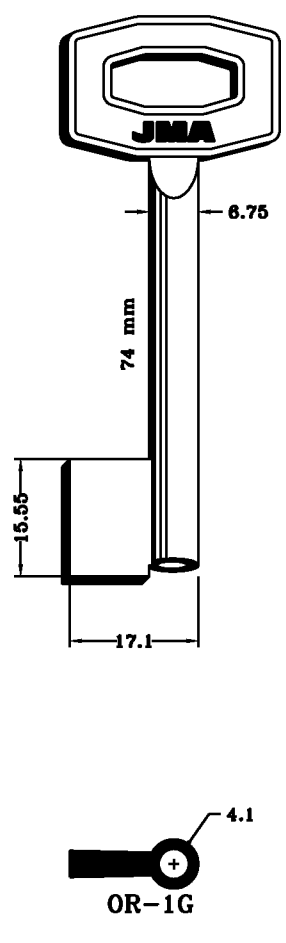
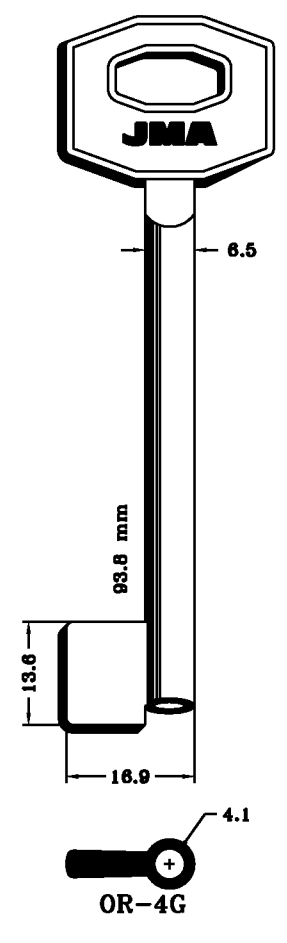
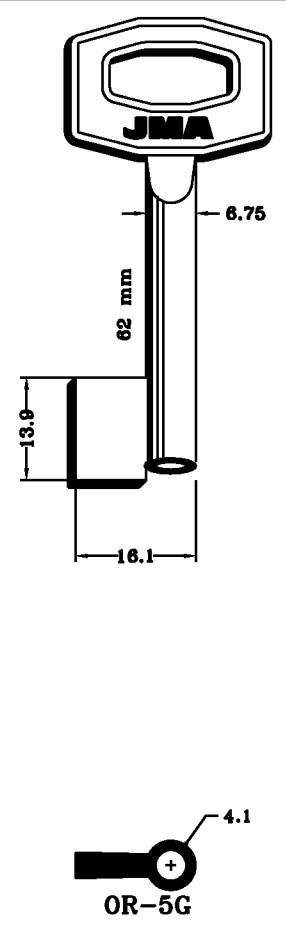
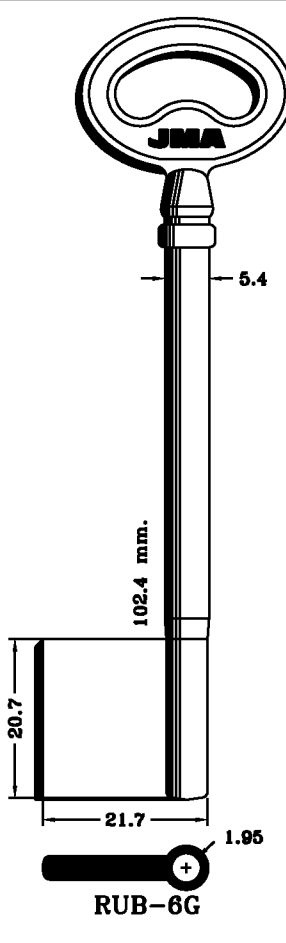
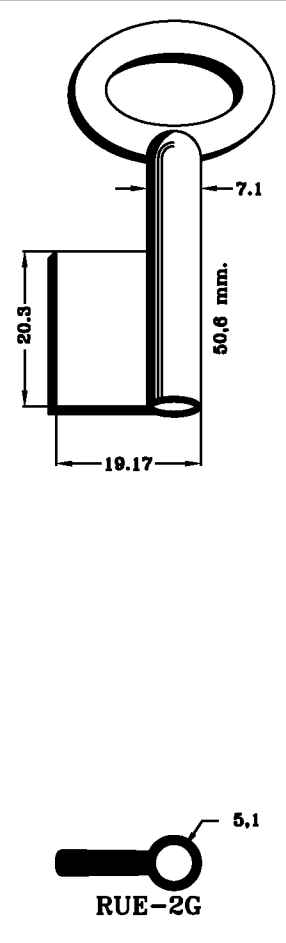
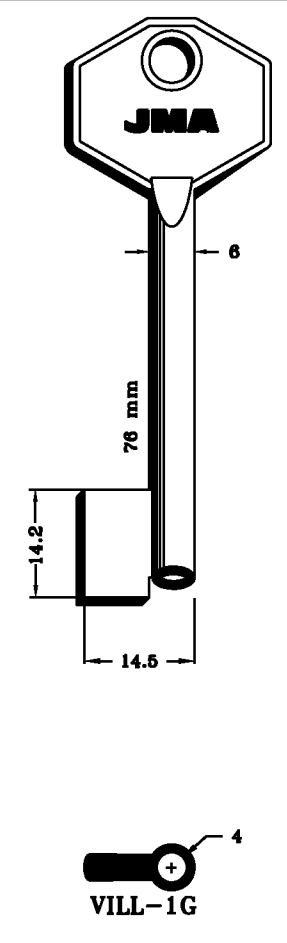
<b>PARA: FOR:</b> LAR	<b>ORENGO</b>		
 <p>Technical drawing of the LAR key. The key has a rounded head with the JMA logo. Dimensions: head width 6.85 mm, stem length 76 mm, bit height 15.4 mm, bit width 17.56 mm. The bit is labeled LAR-3G with a diameter of 4.1 mm.</p>	 <p>Technical drawing of the OR-0G key. The key has a rounded head with the JMA logo. Dimensions: head width 6.8 mm, stem length 76 mm, bit height 16.75 mm, bit width 18.4 mm. The bit is labeled OR-0G with a diameter of 4.1 mm.</p>	 <p>Technical drawing of the OR-1G key. The key has a hexagonal head with the JMA logo. Dimensions: head width 6.75 mm, stem length 74 mm, bit height 15.55 mm, bit width 17.1 mm. The bit is labeled OR-1G with a diameter of 4.1 mm.</p>	 <p>Technical drawing of the OR-4G key. The key has a hexagonal head with the JMA logo. Dimensions: head width 6.5 mm, stem length 93.8 mm, bit height 13.8 mm, bit width 16.9 mm. The bit is labeled OR-4G with a diameter of 4.1 mm.</p>
<b>PARA: FOR:</b> ORENGO	<b>RUBEN</b>	<b>RUE</b>	<b>VILLFER</b>
 <p>Technical drawing of the OR-5G key. The key has a hexagonal head with the JMA logo. Dimensions: head width 6.75 mm, stem length 62 mm, bit height 13.9 mm, bit width 16.1 mm. The bit is labeled OR-5G with a diameter of 4.1 mm.</p>	 <p>Technical drawing of the RUB-6G key. The key has a rounded head with the JMA logo. Dimensions: head width 5.4 mm, stem length 102.4 mm, bit height 20.7 mm, bit width 21.7 mm. The bit is labeled RUB-6G with a diameter of 1.95 mm.</p>	 <p>Technical drawing of the RUE-2G key. The key has a rounded head. Dimensions: head width 7.1 mm, stem length 50.6 mm, bit height 20.3 mm, bit width 19.17 mm. The bit is labeled RUE-2G with a diameter of 5.1 mm.</p>	 <p>Technical drawing of the VILL-1G key. The key has a hexagonal head with the JMA logo. Dimensions: head width 6 mm, stem length 76 mm, bit height 14.2 mm, bit width 14.5 mm. The bit is labeled VILL-1G with a diameter of 4 mm.</p>

Copyright by  
Alejandro Altuna S.A.  
2005

**JMA**

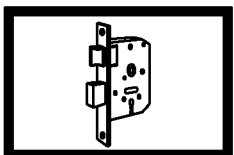

**290**

PARA:  
FOR:

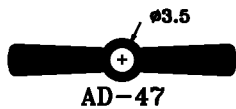
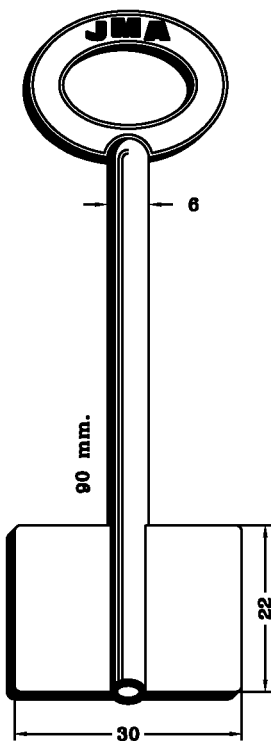
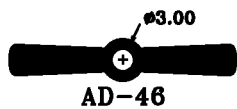
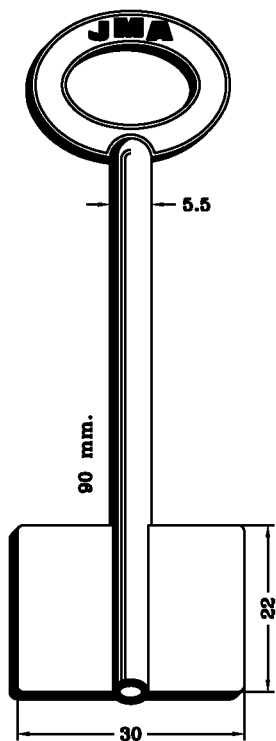

AGA

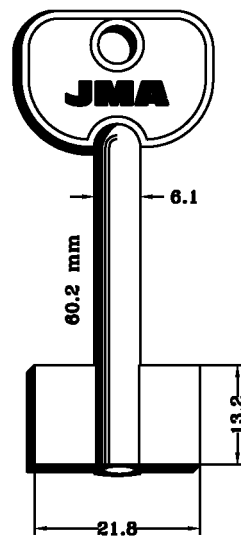

PARA-FOR:

AGA (E)

PARA:  
FOR:

AGA

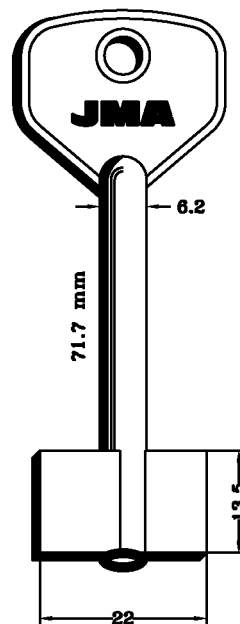
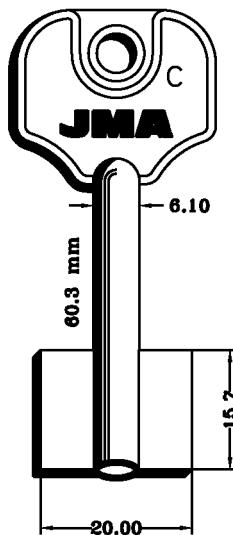
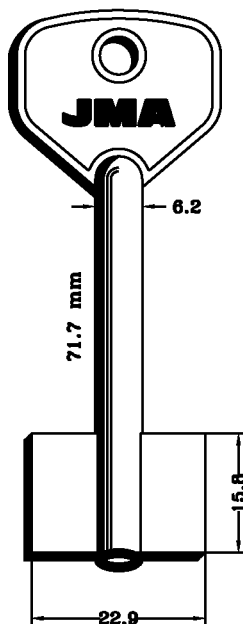
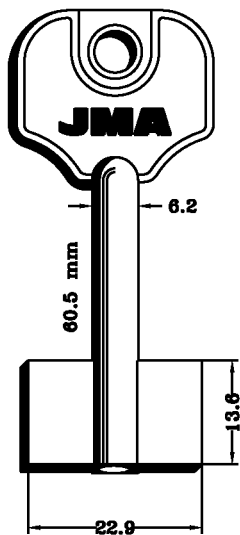

Copyright by  
Alejandro Altuna S.A.  
2005

JMA

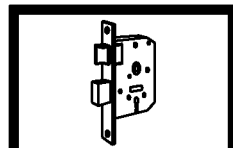

291

**PARA-FOR:**

**ARES (RUS)**

**BURG (D)**

**DUPLEX (RUS)**

**DVERNIAK (RUS)**

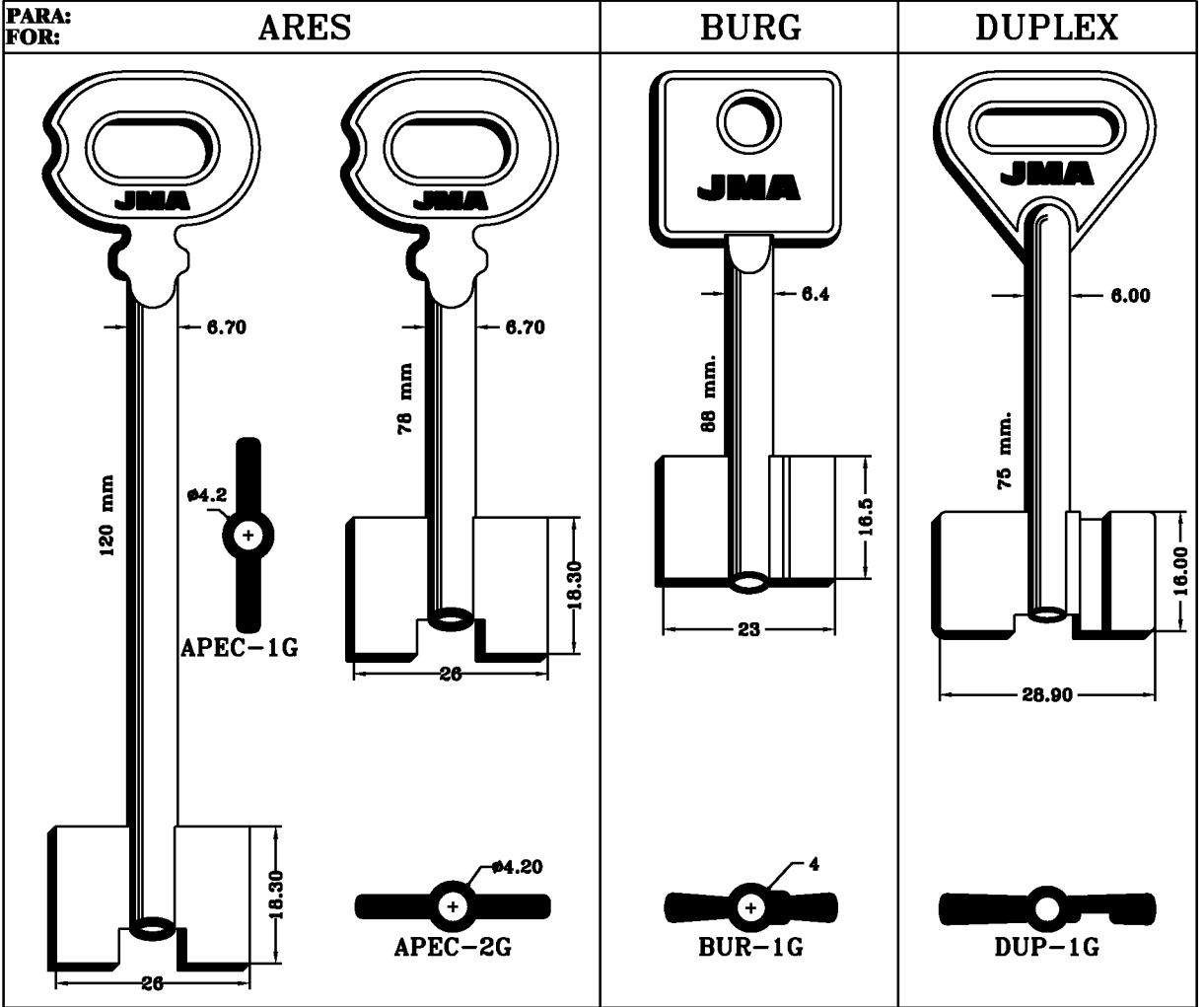

**PARA:  
FOR:** **DVERNIAK**

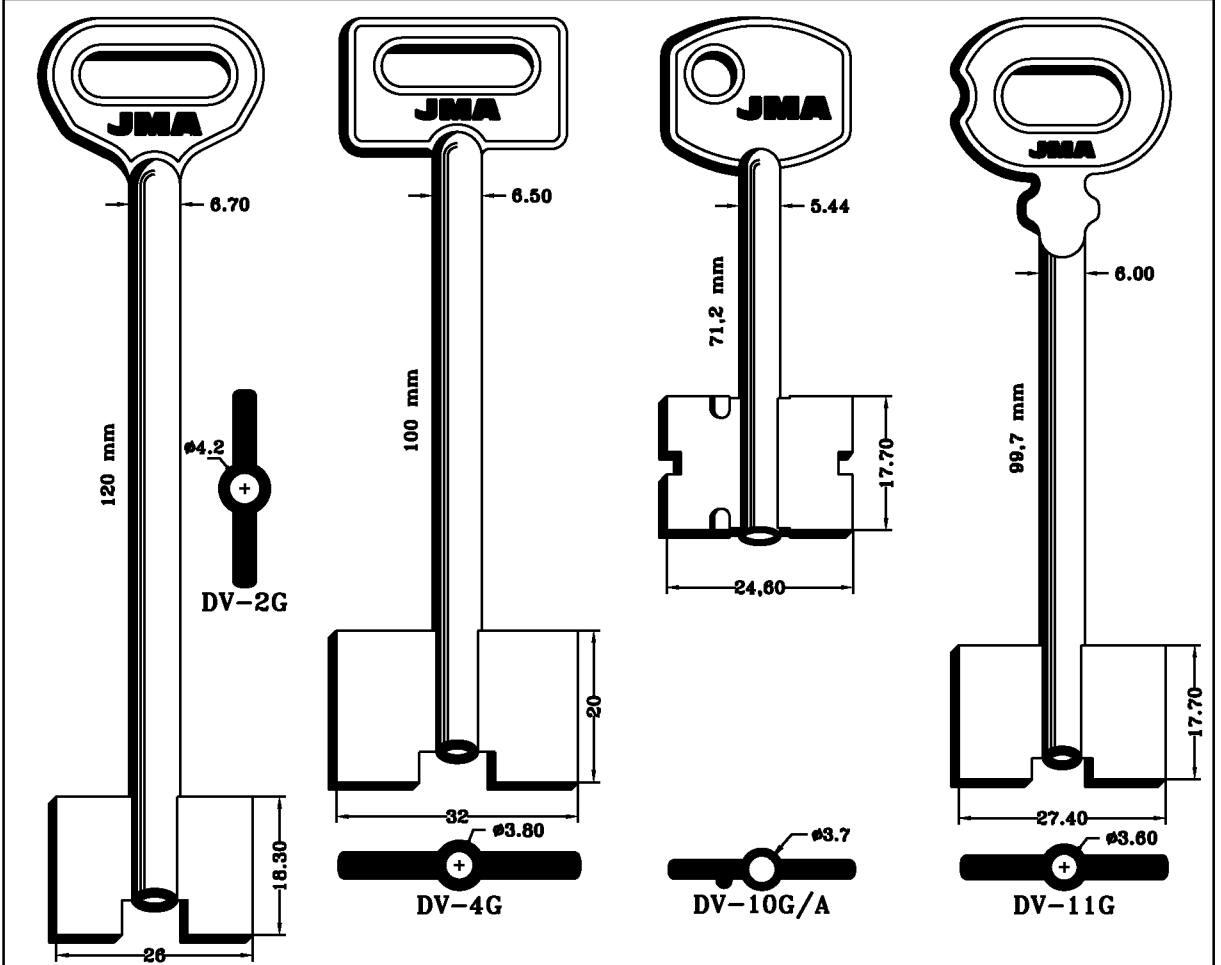

Copyright by  
Alejandro Altuna S.A.  
2005

**JMA**

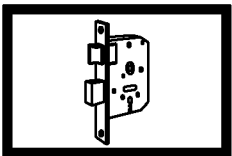

**292**

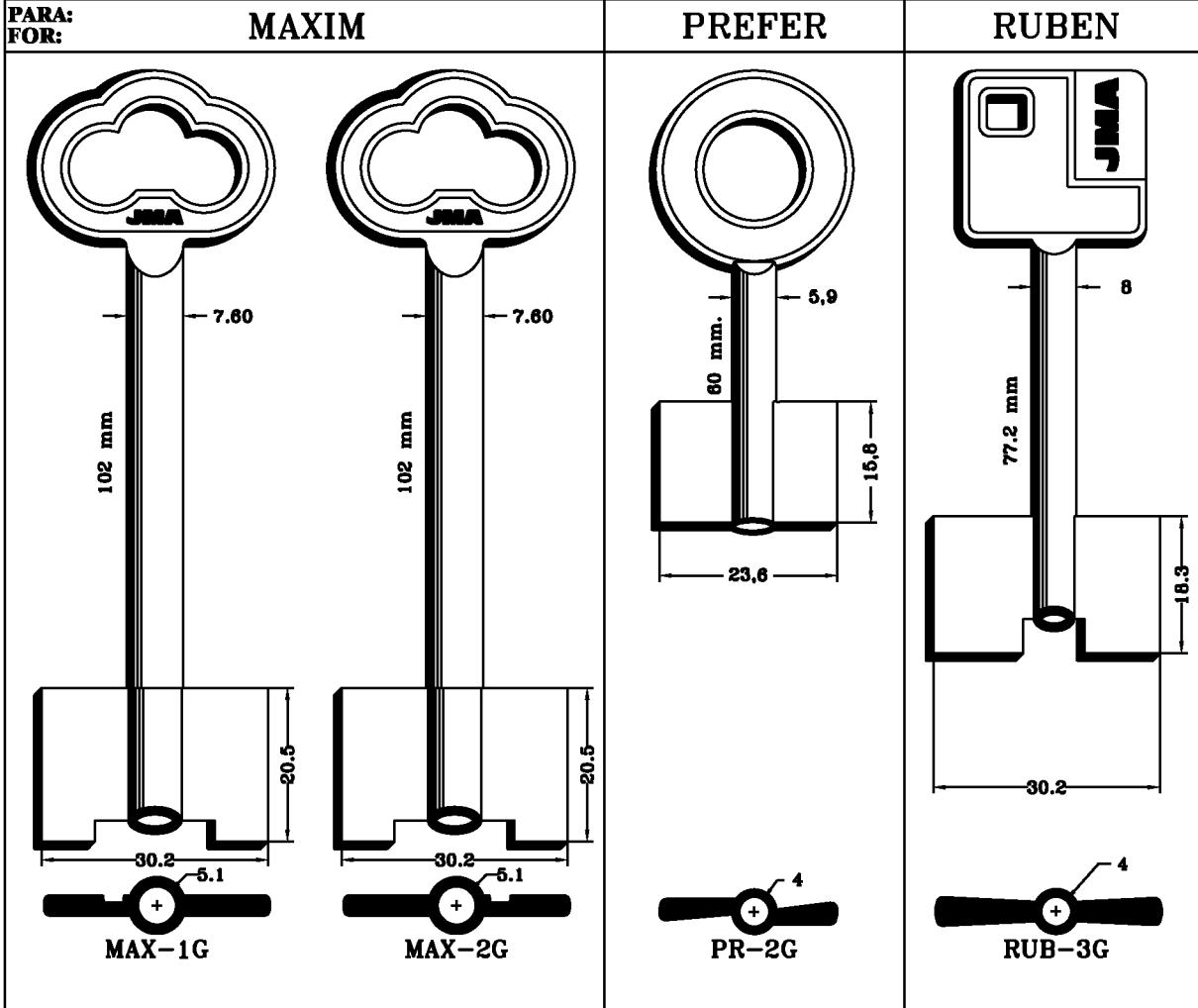
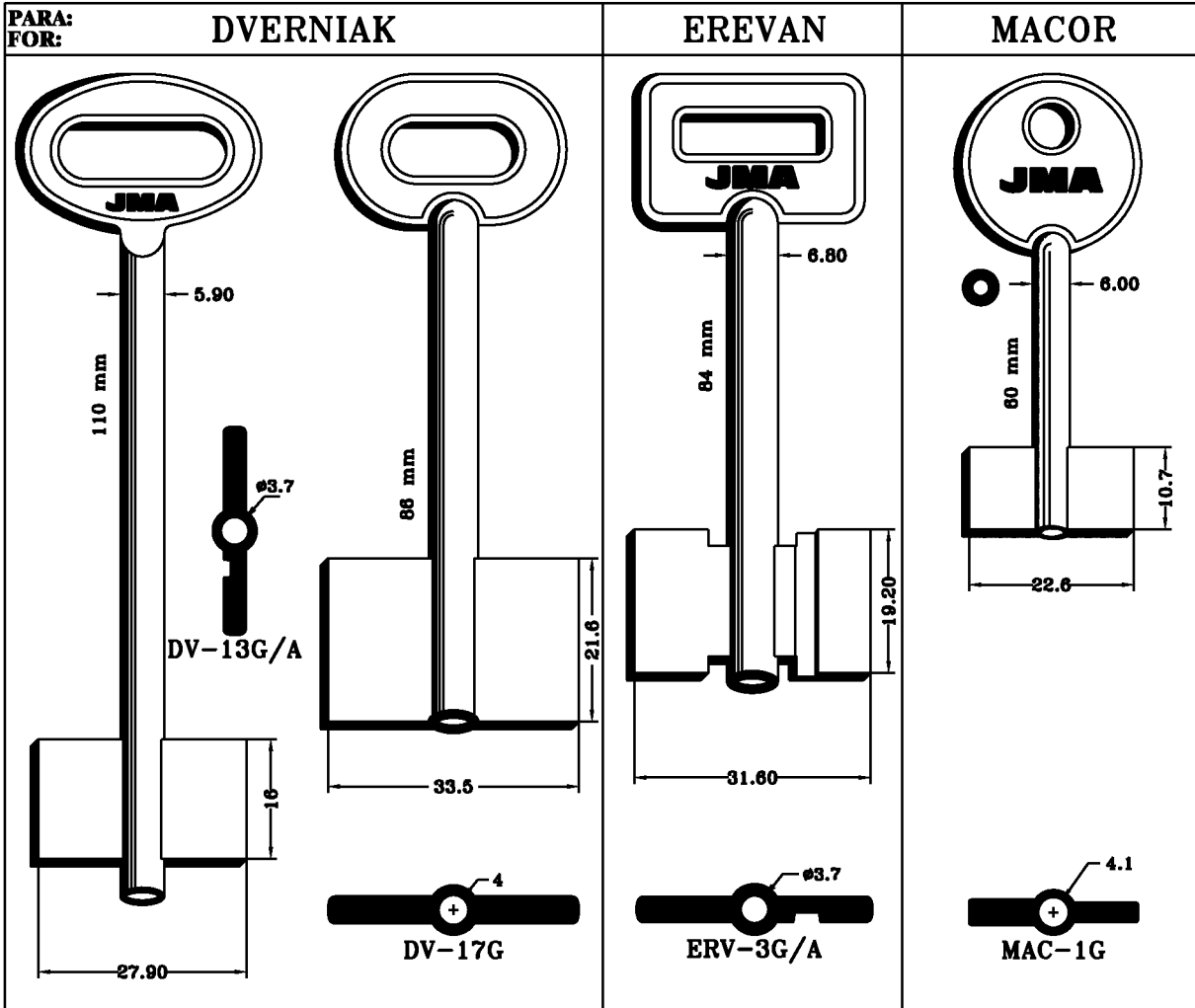

**PARA-FOR:**

**DVERNIAK (RUS)**

**EREVAN (RUS)**

**MACOR (E)**

**MAXIM (RUS)**

**PREFER (I)**

**RUBEN (RUS)**

Copyright by  
Alejandro Altuna S.A.  
2005

**JMA**

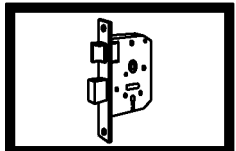

**293**

**PARA-FOR:**

**PARA: SERRALLER**  
**FOR: SERRALLER**

**SIBI**

**SERRALLER**  
**(E)**

**SIBI (I)**

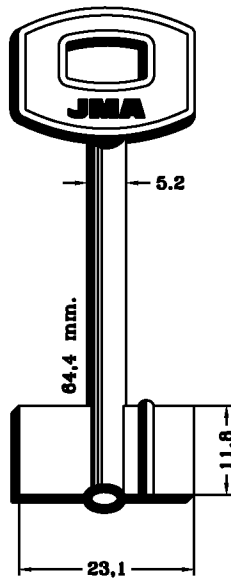
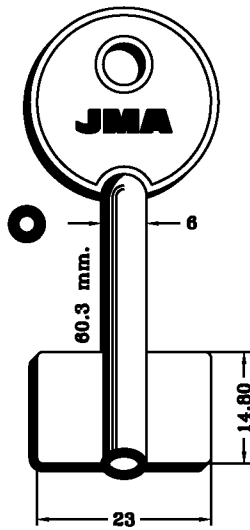

Copyright by  
Alejandro Altuna S.A.  
2005

**JMA**

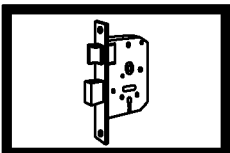

**294**

ATENCION:Concerniente a las marcas y denominaciones comerciales ver nota en indice.ATTENTION:Concerning the marks and commercial denominations see note in index.  
ATTENTION:Concernant les marques et denominations commerciales voir la note dans l'index.ACHTUNG:Beziehen auf die marke und handelsname sehen sie die notiz im index.

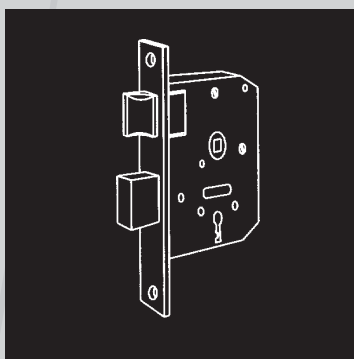

# **JMA**

**LLAVES DE GORJA ZAMAK**

**ZAMAKEZKO GORJA GILTZAK**

**BRASS BIT KEYS**

**CLÉS À GORGES EN ZAMAK**

**CHUBBSCHLÜSSEL AUS ZAMAK**

**CHIAVI A MAPPA DI ZAMA**



PARA: CAS CISMA  
FOR:

NEMEF

PARA-FOR:

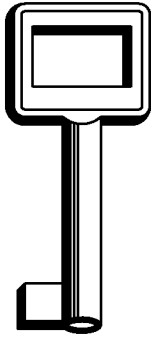

ZAM.



CIS-803/....

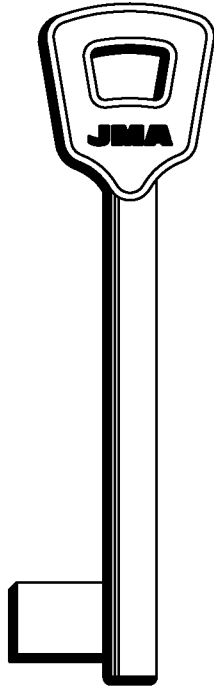

NEF-2Z-..

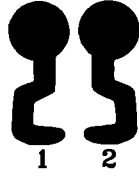

ZAM.

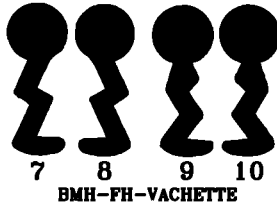
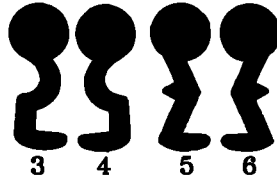

BMH-FH-VACHETTE

CAS CISMA  
(I)

NEMEF (D)

Copyright by  
Alejandro Altuna S.A.  
2005

JMA

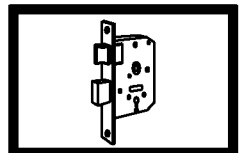

297

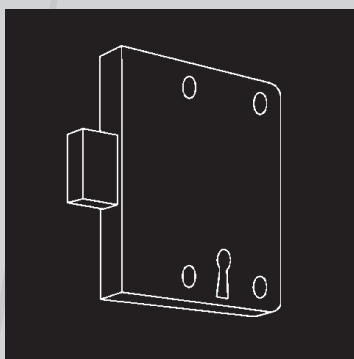

# **JMA**

**LLAVES ARTÍSTICAS Y  
DE ARMARIO LATÓN**

**LETOIZKO GILTZAK, ARMAIRUETARAKO  
ETA ARTISTIKOAK**

**BRASS FURNITURE KEYS**

**CLÉS POUR MEUBLES EN LAITON**

**MOBELSCHLÜSSEL AUS MESSING**

**CHIAVI ARTISTICHE E  
PER MOBILI IN OTTONE**

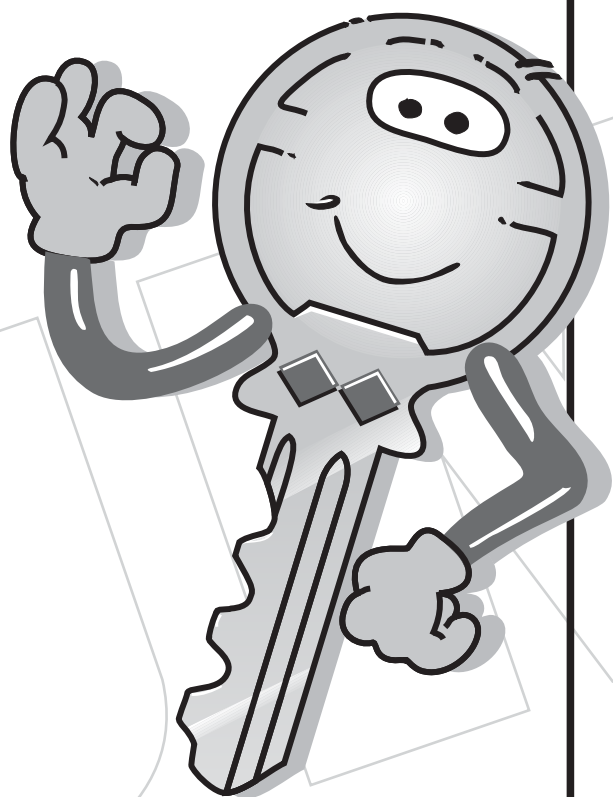

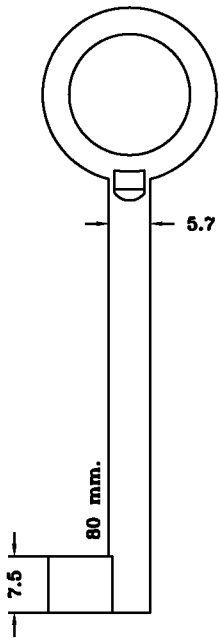

A-0G A-0G CV

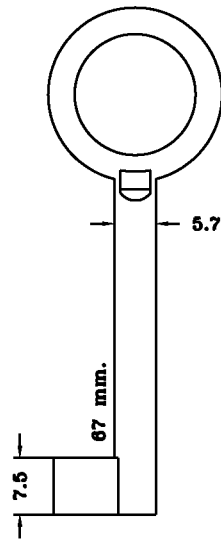

A-1G A-1G CV



A-1G/1 A-1G/2



A-1G/3 A-1G/4



A-1G/5 A-1G/6

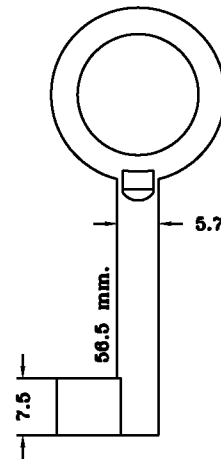

A-2G A-2G CV

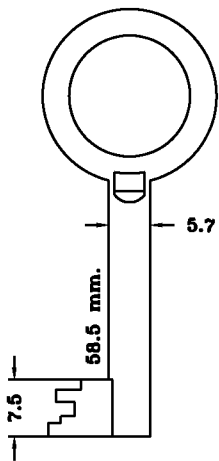
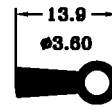

A-2G/1

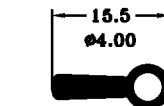
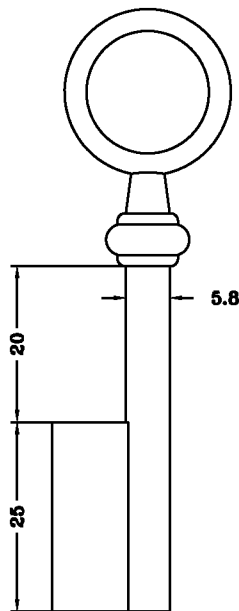

A-3G A-3G CV

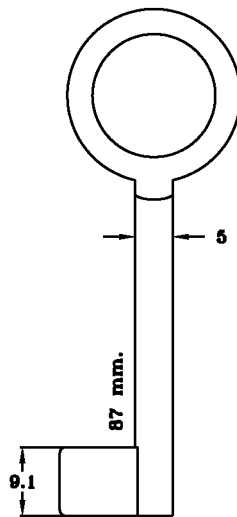

A-4G

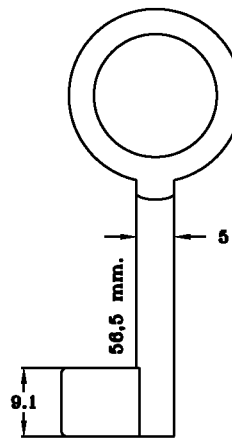

A-5G

Copyright by  
Alejandro Altuna S.A.  
2005

**JMA**

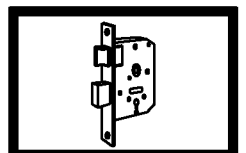

**301**

**PARA-FOR:**

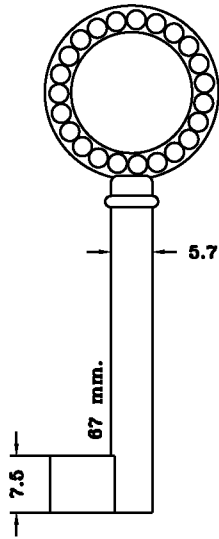

AA-1G AA-1G CV

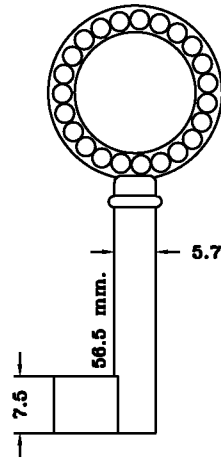

AA-2G AA-2G CV

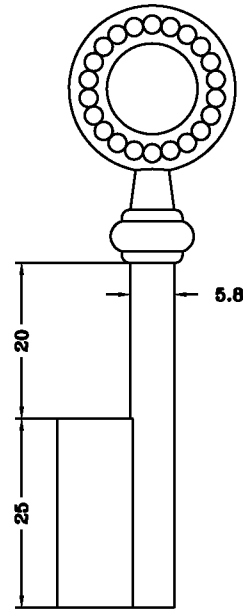

AA-3G AA-3G CV

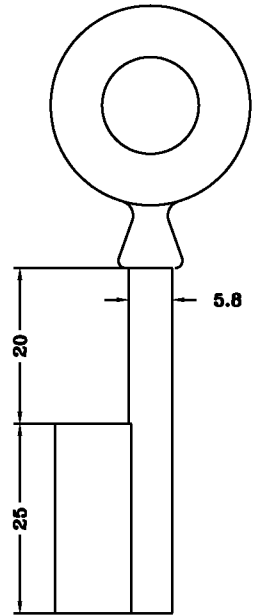

B-3G B-3G CV

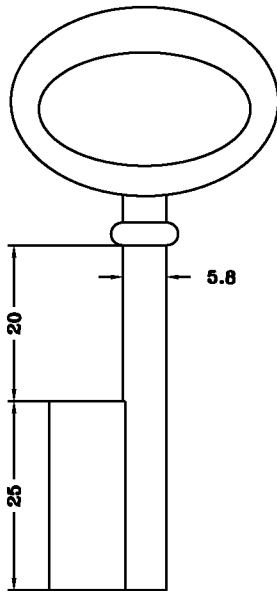
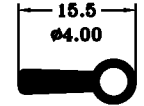
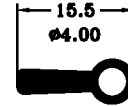

C-3G C-3G CV

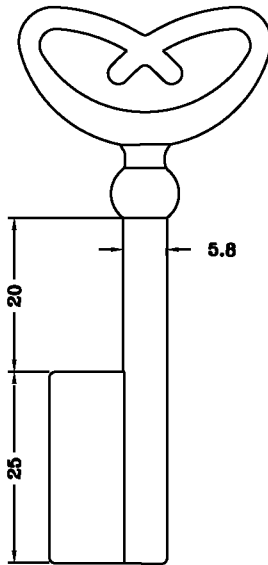

D-3G D-3G CV

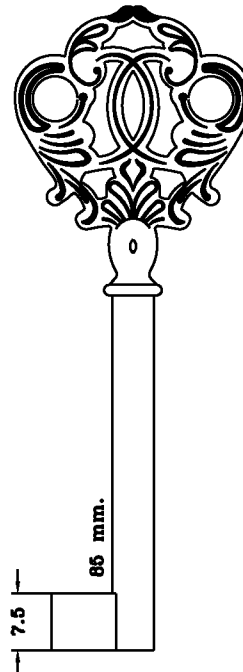

E-0G E-0G CV

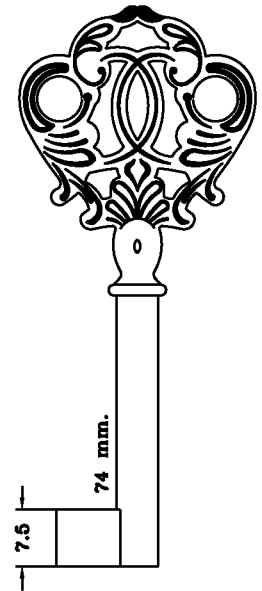

E-1G E-1G CV

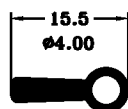
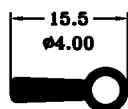

Copyright by  
Alejandro Altuna S.A.  
2005

**JMA**

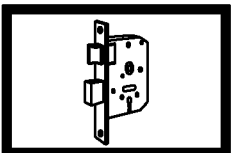

**302**

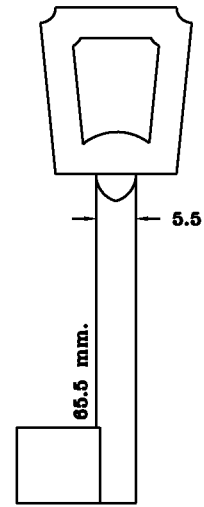
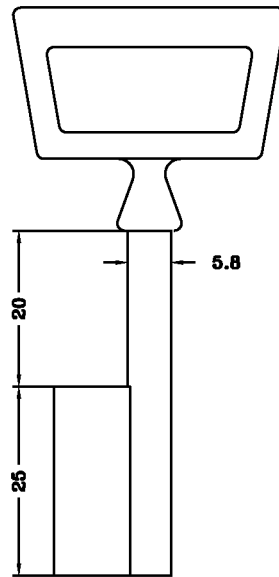
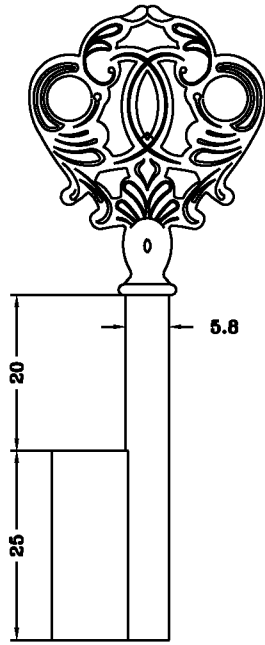
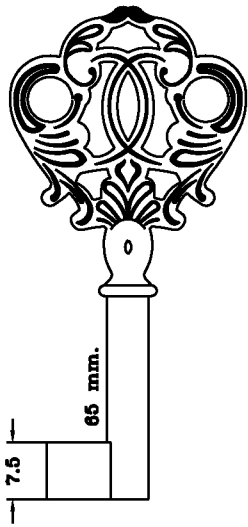

E-2G E-2G CV

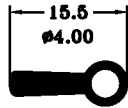

E-3G E-3G CV

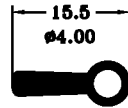

H-3G H-3G CV

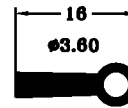

I-1G I-1G NIQ.

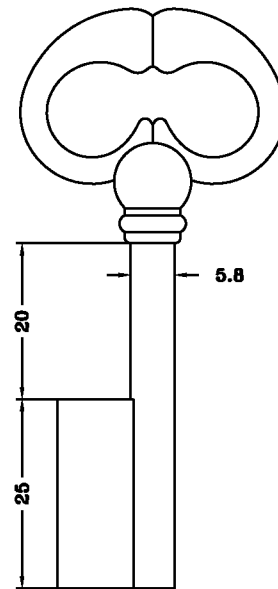
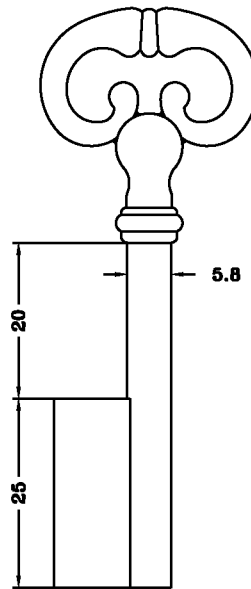
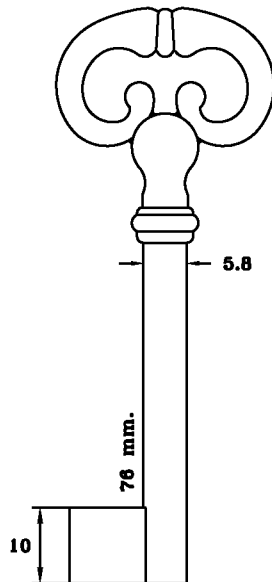
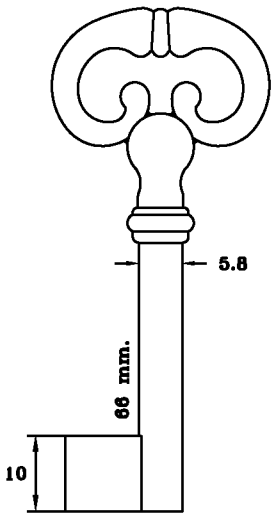

J-1G CV



J-2G CV

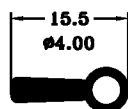

J-3G J-3G CV

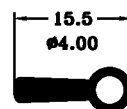

L-3G L-3G CV

Copyright by  
Alejandro Altuna S.A.  
2005

**JMA**

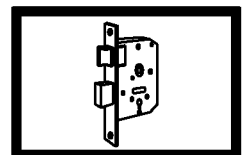

**303**

**PARA-FOR:**

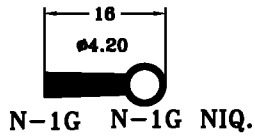
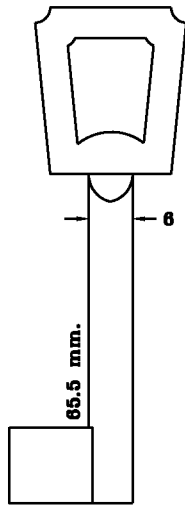

N-1G N-1G NIQ.

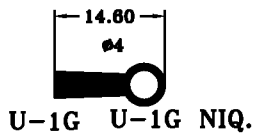
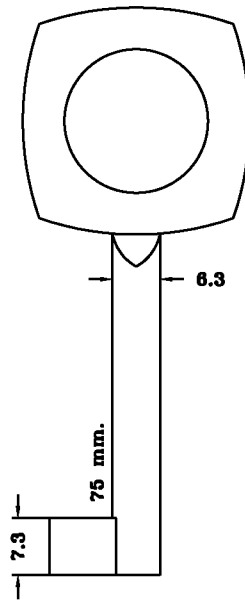

U-1G U-1G NIQ.

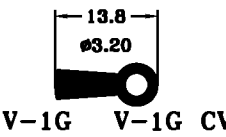
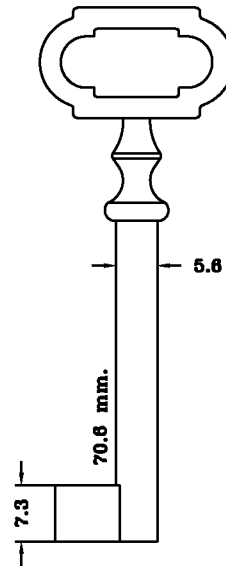

V-1G V-1G CV

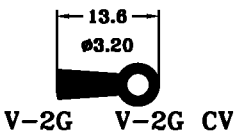
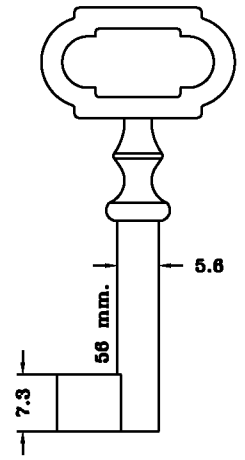

V-2G V-2G CV

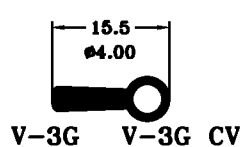
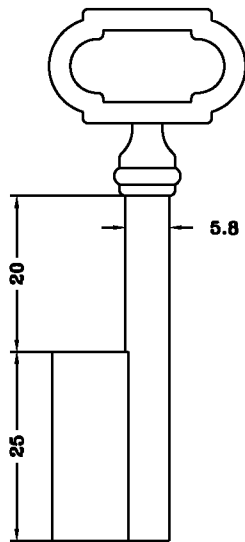

V-3G V-3G CV

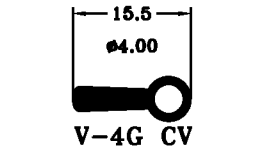
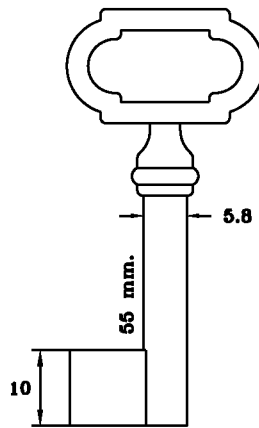

V-4G CV

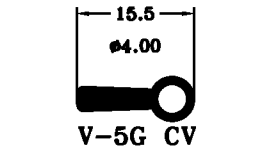
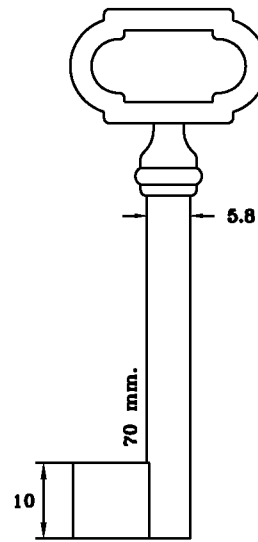

V-5G CV

Copyright by  
Alejandro Altuna S.A.  
2005

**JMA**

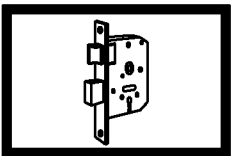

**304**

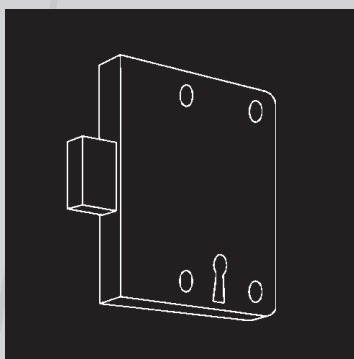

# **JMA**

**LLAVES ARTÍSTICAS Y  
DE ARMARIO ZAMAK**

**ZAMAKEZKO GILTZAK,  
ARMAIRUETARAKO ETA ARTISTIKOAK**

**ZAMAK FURNITURE KEYS**

**CLÉS POUR MEUBLES EN ZAMAK**

**MOBELSCHLÜSSEL AUS ZAMAK**

**CHIAVI ARTISTICHE E  
PER MOBILI IN ZAMA**

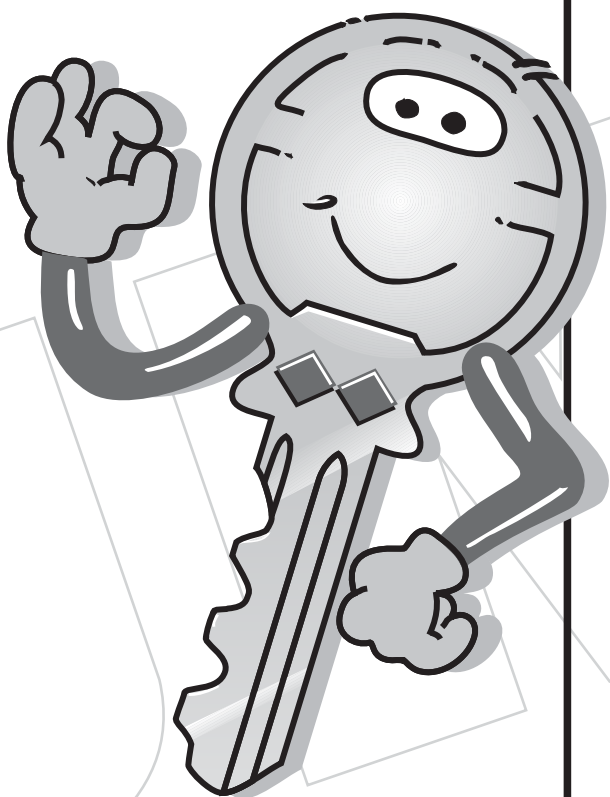

# PARA-FOR:

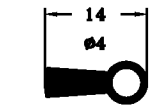
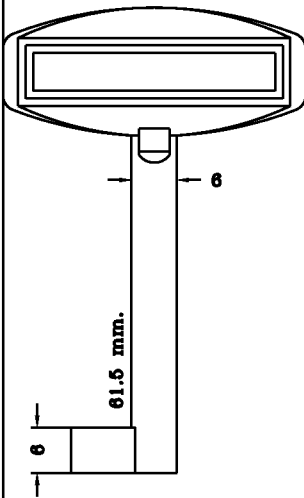

A1 LAT. A1 NIQ.

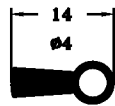
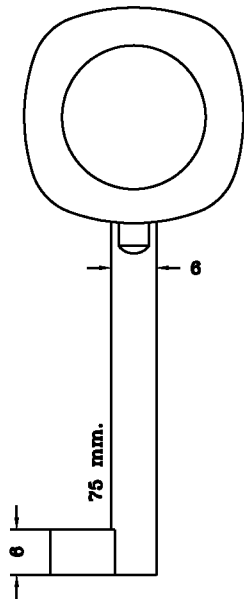

D1 LAT. D1 NIQ.

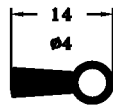
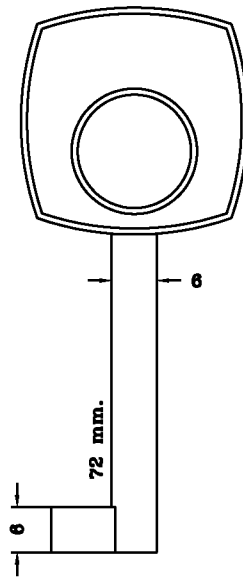

E1 LAT. E1 NIQ.

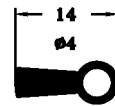
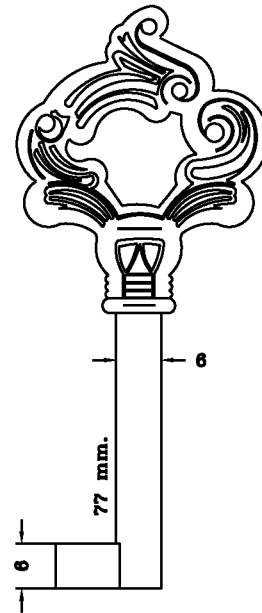

F1 LAT. F1 NIQ.

Copyright by  
Alejandro Altuna S.A.  
2005

# JMA

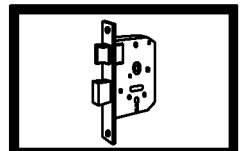

# 307

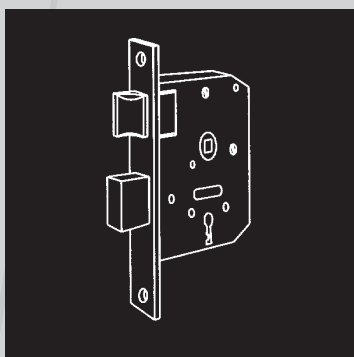

# **JMA**

**LLAVES PARA CASILLAS  
Y ASCENSORES**

**KUTXATILA ETA  
IGOGAILUENTZAKO GILTZAK**

**LIFT AND MAIL BOX KEYS**

**CLÉS POUR ASCENSEURS ET CASIERS**

**FACHKASTEN-UND LIFTSCHLÜSSEL**

**CHIAVI PER ASCENSORI E CASELLARI**

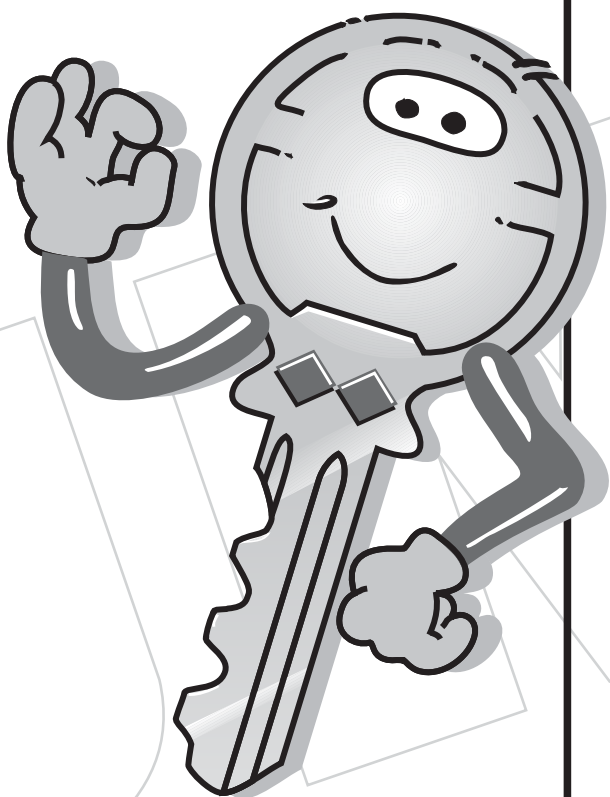

**PARA-FOR:**

**DIEBOLD (D)**

**RIL (E)**

**SERRETA (E)**

**URKO (E)**

**YALE (D-GB)**

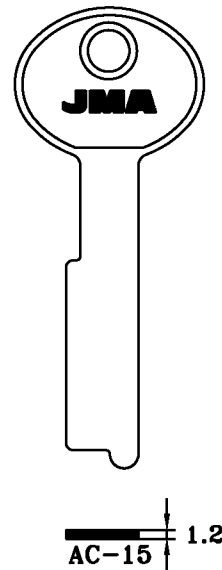
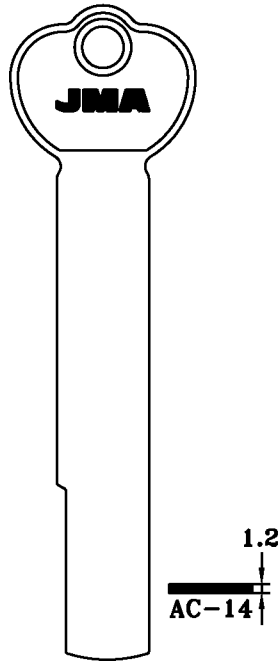
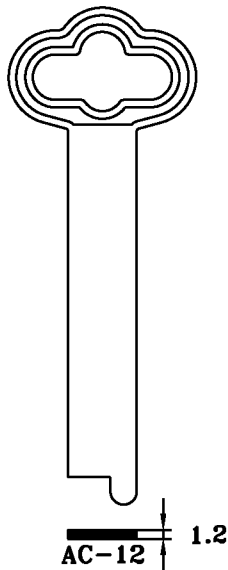
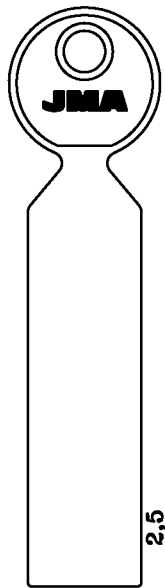

**PARA:** DIEBOLD  
**FOR:**

**RIL**

**SERRETA**

**URKO**

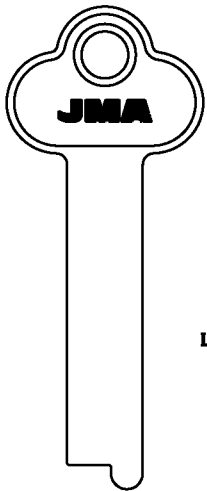

**DIE-1**

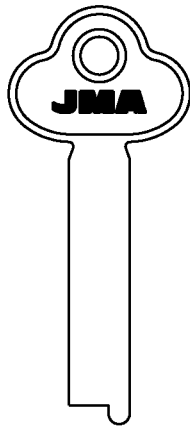

**26-M**

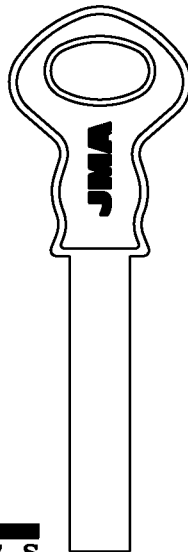

**7-S**

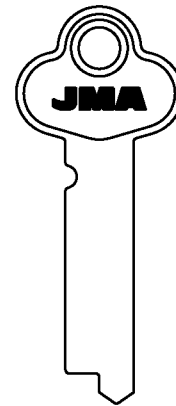

**URKO-4**

**PARA:** YALE  
**FOR:**

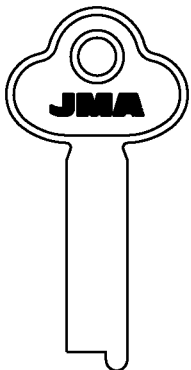

**YA-30**

Copyright by  
Alejandro Altuna S.A.  
2005

**JMA**

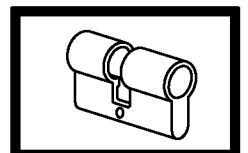

**311**



Tél. 04 73 84 84 94

# **JMA**

**AUTOMOVIL - CAMIONETA**

**AUTOMOBILA - KAMIONETA**

**CAR - PICK-UP TRUCKS**





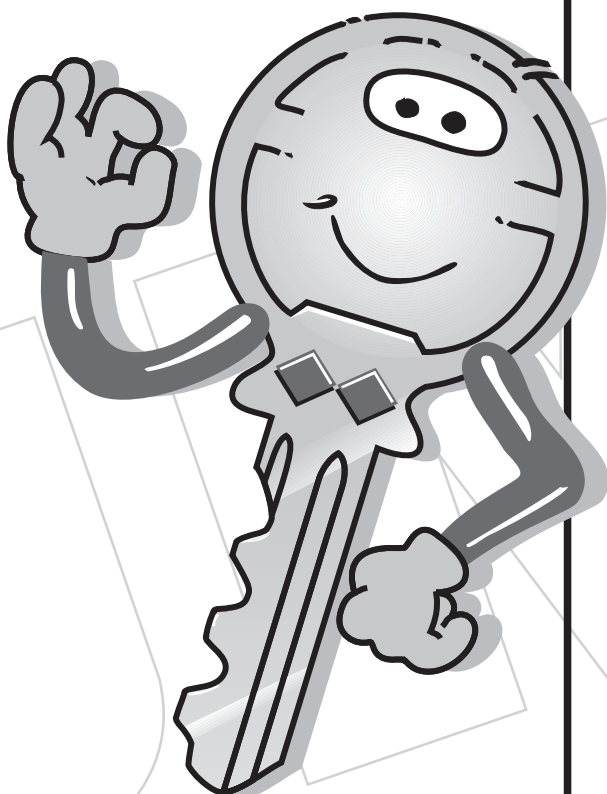

**VOITURE - CAMIONNETTE**

**AUTO - KLEINTRANSPORTER**



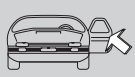



**AUTO - CAMIONCINO**





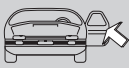



MARCA	MODELO						
ABT	GOLF 3	91-	AU-AH AU-AHP VO-2 VO-2KP VO-2P	AU-AH AU-AHP VO-2 VO-2KP VO-2P	AU-AH AU-AHP VO-2 VO-2KP VO-2P		AU-AH AU-AHP VO-2 VO-2KP VO-2P
ACM	10.1 ENDURO 10.4 ENDURO OFF 4WD	- - -	NE-15I NE-15IP	RO-15	RO-15		
ACURA (HONDA)	INTEGRA LEGEND MODELOS	-89 89-91 86-88	HOND-10 HOND-10P	HOND-10 HOND-10P	HOND-10 HOND-10P		HOND-10 HOND-10P
	INTEGRA VIGOR	90- 92-	HOND-15 HOND-15P	HOND-15 HOND-15P	HOND-15 HOND-15P		HOND-15 HOND-15P
	LEGEND	91-	HOND-17P	HOND-17P	HOND-17P		HOND-17P
	NSX	91-97	HOND-16D HOND-16DP HOND-16DP1	HOND-16D HOND-16DP HOND-16DP1	HOND-16D HOND-16DP HOND-16DP1		HOND-16D HOND-16DP HOND-16DP1
ALFA ROMEO	10 AR 6 13 AR 6	- -	FI-12 FI-12P FI-12P3 FI-3D FI-3DP3 FI-6I FI-6IP4	FI-12 FI-12P FI-12P3 FI-3D FI-3DP3 FI-6I FI-6IP4	FI-12 FI-12P FI-12P3 FI-3D FI-3DP3 FI-6I FI-6IP4		
	30 AR 8 35 AR 8 40 AR 8	-86 -86 -86	AF-7I AF-7IP FI-9I FI-9IP	IMS-3 IMS-3P IMS-5 IMS-5P	IMS-3 IMS-3P IMS-5 IMS-5P		
	30 AR 8 35 AR 8 40 AR 8	86- 86- 86-	FI-2D FI-2DP3 FI-3D FI-3DP1 FI-6I FI-6IP1	FI-2D FI-2DP3 FI-3D FI-3DP1 FI-6I FI-6IP1	FI-2D FI-2DP3 FI-3D FI-3DP1 FI-6I FI-6IP1		
	33	83-86	AF-14 AF-14P FI-6I FI-6IP4	AF-14 AF-14P FI-6I FI-6IP4	AF-14 AF-14P FI-6I FI-6IP4	AF-14 AF-14P FI-6I FI-6IP4	AF-14 AF-14P FI-6I FI-6IP4
	33	86-90	FI-3D FI-3DP4	FI-3D FI-3DP4	FI-3D FI-3DP4	FI-6I FI-6IP4	
	33 75	90- 90-91	AF-14 AF-14P	AF-14 AF-14P	AF-14 AF-14P	AF-14 AF-14P	
	75 MILANO	85-	AF-13 AF-13P	AF-13 AF-13P	AF-13 AF-13P	AF-13 AF-13P	
	75 TD	87-	FI-3D	FI-3D	FI-3D		

MARCA	MODELO						
			FI-3DP4	FI-3DP4	FI-3DP4		
	90	84-85	FI-6I FI-6IP4	FI-6I FI-6IP4	FI-6I FI-6IP4	FI-6I FI-6IP4	FI-6I FI-6IP4
	90	85-	AF-13 AF-13P	AF-13 AF-13P	AF-13 AF-13P	AF-13 AF-13P	AF-13 AF-13P
	145	94	FI-13 FI-13P	FI-13 FI-13P	FI-13 FI-13P	FI-13 FI-13P	FI-13 FI-13P
	155 155 6V 155 T.S.	92-95 92-95 92-95	FI-13 FI-13P FI-14P	FI-13 FI-13P FI-14P	FI-13 FI-13P	FI-13 FI-13P FI-14P	FI-13 FI-13P
	164 164 V6	87-95 87-95	AF-14 AF-14P FI-6I FI-6IP4	AF-14 AF-14P FI-6I FI-6IP4	AF-14 AF-14P		AF-14 AF-14P
	1750 GIULIA 1300 GIULIA 1600	- - -	AF-7I AF-7IP NE-25	AF-5D AF-5I AF-6D AF-6I	AF-5D AF-5I AF-6D AF-6I		
	2000 BERLINA A 11 D A 12 D F 11 D F 12 D GIULIA DIES. SPIDER 1300	- - - - - -	AF-7I AF-7IP	AF-5D AF-5I AF-6D AF-6I	AF-5D AF-5I AF-6D AF-6I		
	2000 COUPE 2000 SPIDER	- -	SIP-3	AF-5D AF-5I AF-6D AF-6I	AF-5D AF-5I AF-6D AF-6I		
	A 11 A 12 F 11 F 12	- - - -		AF-5D AF-5I AF-6D AF-6I	AF-5D AF-5I AF-6D AF-6I		
	A 20 A 38	- -	BH-1 BH-1P	RO-7D	RO-7D		
	ALFA 6	84-	FI-6I FI-6IP4	AF-10 AF-11 AF-12	AF-10 AF-11 AF-12	IMS-3 IMS-3P IMS-5 IMS-5P	
	ALFASUD	-	AF-7I AF-7IP FI-6I FI-6IP4 FI-9I FI-9IP SIP-3	AF-5D AF-5I AF-6D AF-6I	AF-5D AF-5I AF-6D AF-6I	FAB-1	



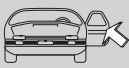



MARCA	MODELO						
	ALFETTA GIULIETTA	78-82 79-81	AF-7I AF-7IP	AF-10 AF-11 AF-12	AF-10 AF-11 AF-12	IMS-5 IMS-5P	
	ALFETTA	82-84	FI-6I FI-6IP4	AF-10 AF-11 AF-12	AF-10 AF-11 AF-12	AF-5D IMS-5 IMS-5P	
	ALFETTA	84-	FI-6I FI-6IP4	AF-10 AF-11 AF-12 FI-6I FI-6IP4	AF-10 AF-11 AF-12 FI-6I FI-6IP4	AF-5D FI-6I FI-6IP4	
	ALFETTA1.6 l ALFETTA1.8 l	- -	AF-7I AF-7IP	AF-5D AF-5I AF-6D AF-6I	AF-5D AF-5I AF-6D AF-6I	AF-5D AF-5I AF-6D AF-6I	
	ALFETTA1.6 2 ALFETTA1.6 G ALFETTA1.8 2 ALFETTA1.8 G ALFETTA2.0 G	- - - - -	AF-7I AF-7IP	AF-10 AF-11 AF-12	AF-10 AF-11 AF-12	AF-5D FAB-1	
	ARNA 1.2 L ARNA 1.2 LS ARNA 1.3 TI	- - -	FI-6I FI-6IP4	DAT-6 DAT-6P	DAT-6 DAT-6P	DAT-6 DAT-6P	
	DUETTO	-	FI-6I FI-6IP4	AF-5D AF-5I AF-6D AF-6I	AF-5D AF-5I AF-6D AF-6I		
	GIULIETTA	81-	FI-6I FI-6IP4	GIOB-3P	GIOB-3P	FI-6I FI-6IP4 IMS-3 IMS-3P IMS-5 IMS-5P	
	GTV 2.0 GTV 2.0 6V GTV 2.5 GTV 2.5 6V	82-95 84-95 82-95 84-95	FI-6I FI-6IP4	GIOB-3P	GIOB-3P	AF-5D IMS-3 IMS-3P IMS-5 IMS-5P	
	MONTREAL	-	AF-7I AF-7IP	IMS-3 IMS-3P IMS-5 IMS-5P	IMS-3 IMS-3P IMS-5 IMS-5P		
	SPIDER	70-89	AF-7I AF-7IP FI-6I FI-6IP4 SIP-3	AF-5D AF-5I AF-6D AF-6I	AF-5D AF-5I AF-6D AF-6I		

MARCA	MODELO						
	SPIDER	90-91	AF-14 AF-14P	AF-5D AF-5I AF-6D AF-6I	AF-5D AF-5I AF-6D AF-6I		AF-14 AF-14P
	SPIDER	91-95	AF-13 AF-13P	AF-13 AF-13P	AF-13 AF-13P		
	SPRINT	-	AF-7I AF-7IP	AF-5D AF-5I AF-6D AF-6I	AF-5D AF-5I AF-6D AF-6I	FAB-1	
	SZ COUPE	91-	AF-14 AF-14P	AF-14 AF-14P	AF-14 AF-14P		AF-14 AF-14P
AMERICAN MOTORS	ALLIANCE ENCORE	81-83 81-83	CHR-3 CHR-3P	NE-16 NE-59P VA-10	NE-16 NE-59P VA-10	NE-16 NE-59P VA-10	
	ALLIANCE ENCORE	84-85 84-85	CHR-3 NE-19 NE-19P NE-22P	NE-16 NE-59P VA-10	NE-16 NE-59P VA-10	NE-16 NE-59P VA-10	
	ALLIANCE ENCORE	85-86 85-86	CHR-3 NE-22P	BAS-1I	BAS-1I		
	ALLIANCE ENCORE	86-88 86-88	NE-19 NE-19P	BAS-1I	BAS-1I		
	COMANCHE CHEROKEE WAGONEER W.BASE W.ISLANDER W.LAREDO W.SAHARA W.TEXAS	-90 -90 -90 -90 -90 -90 -90 -90	BAS-1I GM-9 GM-9P GM-J GM-JP	BAS-1I	BAS-1I		
	COMANCHE CHEROKEE	91-92 91-92	CHR-9 CHR-9P	CHR-9 CHR-9P	CHR-9 CHR-9P		CHR-9 CHR-9P
	MJ COMANCHE XJ CHEROKEE YJ WRANGLER ZJ G.CHEROKEE	93- 93- 93- 93-	CHR-10 CHR-10P	CHR-10 CHR-10P	CHR-10 CHR-10P		CHR-10 CHR-10P
	MODELOS	53-69	BS-1I	BS-1I	BS-1I		BS-1I
	MODELOS	70-85	BAS-1I	BAS-1I	BAS-1I		BAS-1I
	WAGONEER	91-92	CHR-9 CHR-9P GM-9 GM-9P GM-J	BAS-1I CHR-9 CHR-9P	BAS-1I CHR-9 CHR-9P		CHR-9 CHR-9P



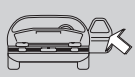



MARCA	MODELO						
			GM-JP				
ARO DACIA	203	-	BH-1 BH-1P	HU-1			
	240	82-85	BH-1 BH-1P	RO-15			
	240 241 242 243 244 ISCHIA 10.1 ISCHIA 10.4 SUPER ISCHIA	85- 85- 85- 85- 85- 85- 85- 85-	NE-15I NE-15IP1	RO-15	RO-15		
ASTON MARTIN	LAGONDA	-	FO-E/TC	FO-E/TC	FO-E/TC	IN-1	IN-1
	LAGONDA LIM.	-	FO-E/TCP	FO-E/TCP	FO-E/TCP	UN-FP	UN-FP
	V8 SALOON	-	FO-FR	IN-1	IN-1	UN-FS	UN-FS
	V8 VANTAGE	-	FO-FRP	OP-WHP	OP-WHP	UN-FT	UN-FT
	V8 VANTAGE Z	-	OP-WHP	OP-WYP	OP-WYP		
	V8 VOLANTE	-	OP-WYP	UN-FP	UN-FP		
	V8 VOLANTE C	-		UN-FS UN-FT	UN-FS UN-FT		
AUDI	50 GL 50 LS	74- 74-	VO-VB VO-VBP	VO-VB VO-VBP	AU-W		
	60 100 100 L 100 LS	- 73-77 73-77 73-77			AU-W		
	80 100 200 4000 5000	78-82 78-82 78-82 78-82 78-82	AU-1 AU-HV AU-HVP VO-3KP VO-VB VO-VBP	AU-1 AU-HV AU-HVP VO-3KP VO-VB VO-VBP	AU-1 AU-HV AU-HVP VO-3KP		
	80	83-84	AU-1 AU-HV AU-HVP1 VO-3KP VO-HV VO-VB VO-VBP	AU-1 AU-HV AU-HVP1 VO-3KP VO-HV VO-VB VO-VBP	AU-1 AU-HV AU-HVP1 VO-3KP VO-HV	AU-1 AU-HV AU-HVP1 VO-3KP VO-HV	AU-1 AU-HV AU-HVP1 VO-3KP VO-HV
	80 QUATTRO	84-85 84-85	AU-AH AU-AHP1 AU-AN AU-ANP VO-2 VO-2KP VO-2P	AU-AH AU-AHP1 AU-AN AU-ANP VO-2 VO-2KP VO-2P	AU-AH AU-AHP1 VO-2 VO-2KP VO-2P	AU-AH AU-AHP1 VO-2 VO-2KP VO-2P	AU-AH AU-AHP1 VO-2 VO-2KP VO-2P
	80	85-	AU-AH	AU-AH	AU-AH	AU-AH	AU-AH

MARCA	MODELO						
	90 100 200 4000 5000 CABRIO COUPE QUATTRO V8	85- 85- 85- 85- 85- 85-95 85-95 85- 85-	AU-AHP AU-AN AU-ANP VO-2 VO-2KP VO-2P	AU-AHP AU-AN AU-ANP VO-2 VO-2KP VO-2P	AU-AHP VO-2 VO-2KP VO-2P	AU-AHP AU-AN AU-ANP VO-2 VO-2KP VO-2P	AU-AHP VO-2 VO-2KP VO-2P
	80 GLS 80 GT	79 79	VO-VB VO-VBP	VO-VB VO-VBP	AU-W	BL-1D	
	100 100 GLS 100 L	79 79 79	NE-1 NE-1P	AU-W	AU-W		
	COUPE GT QUATTRO	82-84 82-84	AU-1 AU-HV AU-HVP VO-3KP VO-HV VO-VB VO-VBP	AU-1 AU-HV AU-HVP VO-3KP VO-HV VO-VB VO-VBP			AU-1 AU-HV AU-HVP VO-3KP
	FOX	73-77	VO-3KP VO-HV VO-HVP	VO-3KP VO-HV VO-HVP	AU-W		
AUSTIN	SHERPA 185 SHERPA 230 SHERPA 255	- - -	LF-BL LF-RO LF-ROP	UN-1FS UN-FT	UN-1FS UN-FT		
AUTOBIANCHI	A111	-	AF-7I AF-7IP AF-8D AF-8DP AF-8I AF-8IP AF-9D AF-9DP AF-9I AF-9IP	IMS-3 IMS-3P IMS-5 IMS-5P	IMS-3 IMS-3P IMS-5 IMS-5P		
	A112	71-77	AF-7I AF-7IP FI-9I FI-9IP SIP-3	IMS-3 IMS-3P IMS-5 IMS-5P	IMS-3 IMS-3P IMS-5 IMS-5P		
	A112	78-81	AF-7I AF-7IP FO-FR FO-FRP	IMS-3 IMS-3P IMS-5 IMS-5P	IMS-3 IMS-3P IMS-5 IMS-5P	AF-5D	
	A112	81-84	AF-7I AF-7IP FI-8I	IMS-3 IMS-3P IMS-5	IMS-3 IMS-3P IMS-5	AF-5D	



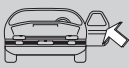



MARCA	MODELO						
			FI-8IP FI-9I FI-9IP	IMS-5P	IMS-5P		
	A112	84-86	FI-3D FI-3DP3 FI-6I FI-6IP3	FI-3D FI-3DP3 FI-6I FI-6IP3 IMS-3 IMS-3P IMS-5 IMS-5P	FI-3D FI-3DP3 FI-6I FI-6IP3 IMS-3 IMS-3P IMS-5 IMS-5P	FAB-1	
	A112 (1.SER)	69-71	AF-7I AF-7IP AF-8D AF-8DP AF-8I AF-8IP AF-9D AF-9DP AF-9I AF-9IP FO-FR FO-FRP	IMS-3 IMS-3P IMS-5 IMS-5P	IMS-3 IMS-3P IMS-5 IMS-5P		
	BIANCHINA	-	FEM-1D FEM-1I FEM-2D FEM-2I	AF-5D AF-5I AF-6D AF-6I	AF-5D AF-5I AF-6D AF-6I		
	PRIMULA	-	AF-7I AF-7IP FEM-1D FEM-1I FEM-2D FEM-2I				
	Y10	86-	FI-1 FI-11 FI-11KP FI-11P FI-1P FI-1P8	FI-1 FI-11 FI-11KP FI-11P FI-1P FI-1P8	FI-1 FI-11 FI-11KP FI-11P FI-1P FI-1P8	FI-1 FI-11 FI-11KP FI-11P FI-1P FI-1P8	
BEDFORD	MIDI VAN MIDI WAGON WINDOW VAN	- - -	TOYO-14 TOYO-14P	TOYO-14 TOYO-14P	TOYO-14 TOYO-14P		
	RASCAL	-	GM-1P	GM-1P	GM-1P		
BENTLEY	CONTINENTAL EIGHT TURBO	- - -	YA-18D YA-19D	YA-18D YA-19D	YA-19D		YA-18D YA-19D
	MULSANNE	87-	YA-20I YA-21I	YA-20I YA-21I	YA-21I		YA-20I YA-21I
BERTONE	FREECLIMBER	-	DAI-1P	DAI-1P	DAI-1P		

MARCA	MODELO						
	SL-CABRIO	-	MIT-12 MIT-7 MIT-7P	MIT-12 MIT-7 MIT-7P	MIT-12 MIT-7 MIT-7P		
BMA	AMICA 250 AMICA 360 D AMICA 50-125	- - -	AF-9D AF-9DP AF-9I AF-9IP FEM-1I	UN-MRN			
BMW	524 TD SERIE 7	84-86 84-86	BM-2 BM-2P BM-HB BM-HBP	BM-2 BM-2P BM-HB BM-HBP	BM-2 BM-2P	BM-2 BM-2P	BM-2 BM-2P
	1502 1600 1602 1800 1802 2000 2002	68-76 68-76 68-76 68-76 68-76 68-76 68-76	BM-W	BM-B HU-SX	BM-B HU-SX		
	2000 TOURING	68	BM-W	BM-W	BM-W		
	2002 TOURING	79	BM-W	BM-W	BM-B		
	2500	68-	BM-1P	BM-1P	BM-B		
	2800 3000 3800 BAVARIA	70-75 70-75 70-75 70-75	BM-1P	BM-1P	BM-1P		
	SERIE 3 SERIE 5 SERIE 6 SERIE 7	75-84 75-84 75-84 75-84	BM-3 BM-3P BM-HB BM-HBP BM-NB BM-NBP	BM-3 BM-3P BM-HB BM-HBP BM-NB BM-NBP	BM-3 BM-3P BM-HB BM-HBP	BM-3 BM-3P BM-HB BM-HBP	BM-3 BM-3P BM-HB BM-HBP
	SERIE 3	87-90	BM-2 BM-2P BM-NB BM-NBP	BM-2 BM-2P BM-NB BM-NBP	BM-2 BM-2P		BM-2 BM-2P
	SERIE 3 SERIE 5 SERIE 7 SERIE 8	90-95 88-95 88-95 88-95	BM-4 BM-5P	BM-4 BM-5P	BM-5P		BM-5P
	CARBODIES	FAIRWAY FX4S	-	LF-RO LF-ROP	IN-4 IN-5	IN-4 IN-5	UN-FS
CITROEN	2 CV	70-	CT-3 CT-3P CT-4P	LAS-P RO-4D RO-4I	LAS-P RO-4D RO-4I	FAB-1	



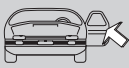



MARCA	MODELO						
	ACADIANE	-	CT-2P1 CT-3 CT-3P	RO-4D RO-4I	RO-4D RO-4I		
	AMI 6 AMI 8	69- 69-	CT-3 CT-3P	RO-5D RO-5I	RO-5D RO-5I		
	AX BX	86-89 82-90	CL-8P SIX-1 SIX-1KP SIX-1P SIX-2 SIX-2P	CL-8P SIX-1 SIX-1KP SIX-1P SIX-2 SIX-2P	CL-8P SIX-1 SIX-1KP SIX-1P SIX-2 SIX-2P		
	AX	89-94	NE-36 NE-36KP1 NE-36P1 SIX-1 SIX-1KP SIX-1P SIX-2 SIX-2P	NE-36 NE-36KP1 NE-36P1 SIX-1 SIX-1KP SIX-1P SIX-2 SIX-2P	NE-36 NE-36KP1 NE-36P1 SIX-1 SIX-1KP SIX-1P SIX-2 SIX-2P		
	AX ZX	94 94	NE-20P3 NE-36	NE-20P3 NE-36	NE-20P3 NE-36		NE-20P3 NE-36
	AX ZX	95 95	SIX-3P2	SIX-3P2	SIX-3P2		SIX-3P2
	AX 14D COME.	-	SIX-1 SIX-1KP SIX-1P1	SIX-1 SIX-1KP SIX-1P1	SIX-1 SIX-1KP SIX-1P1		
	AXEL	84-	CHR-3 CHR-3P NE-22P1	CHR-3 CHR-3P NE-22P1	AB-5D AB-5I		
	BERLINGO	97	SIX-3P1	SIX-3P1	SIX-3P1	SIX-3P1	
	BX	90-	NE-36 NE-36KP1 NE-36P1 SIX-1 SIX-1KP SIX-1P SIX-2 SIX-2P	NE-36 NE-36KP1 NE-36P1 SIX-1 SIX-1KP SIX-1P SIX-2 SIX-2P		NE-36 NE-36KP1 NE-36P1 SIX-1 SIX-1KP SIX-1P SIX-2 SIX-2P	NE-36 NE-36KP1 NE-36P1 SIX-1 SIX-1KP SIX-1P SIX-2 SIX-2P
	CX	74-85	CT-3 CT-3P	AB-5D AB-5I RO-5D RO-5I	AB-5D AB-5I RO-5D RO-5I		LAS-V
	CX	85-	SIX-1 SIX-1KP SIX-1P SIX-2 SIX-2P	SIX-1 SIX-1KP SIX-1P SIX-2 SIX-2P	SIX-1 SIX-1KP SIX-1P SIX-2 SIX-2P		LAS-R LAS-V

MARCA	MODELO						
	C-15 D C-15 E	- -	SIX-1 SIX-1KP SIX-1P	SIX-1 SIX-1KP SIX-1P	SIX-1 SIX-1KP SIX-1P	AB-10I	
	C-25 FURGON.	-	FI-6I FI-6IP3	FI-6I FI-6IP3	FI-6I FI-6IP3		
	D DS	-74 -74	CT-1 CT-1P CT-3 CT-3P	RO-5D RO-5I	RO-5D RO-5I		
	DYANE	67-80	CT-2 CT-2P CT-2P1 CT-3 CT-3P	RO-4D RO-4I	RO-4D RO-4I	FAB-1	
	DYANE	80-	SIX-1 SIX-1KP SIX-1P SIX-2 SIX-2P	RO-4D RO-4I	RO-4D RO-4I		
	EVASION JUMPI	94 96-	SIX-3P1	SIX-3P1	SIX-3P1		SIX-3P1
	G GS GSA	70- 70- 70-	CT-3 CT-3P	AB-5D RO-5D RO-5I	AB-5D RO-5D RO-5I		
	JUMPER	96-	FI-11P	FI-11P	FI-11P	FI-11P	FI-11P
	LN LNA	76-84 76-84	NE-4 NE-4P1	VA-6 VA-6P	VA-6 VA-6P		
	LNA	84-	CHR-3 CHR-3P NE-22P1	VA-6 VA-6P	VA-6 VA-6P	PJ-2 PJ-2P PJ-K PJ-KP	
	MEHARI	68-	CT-3 CT-3P CT-4P	RO-4D RO-4I	RO-4D RO-4I		
	PLUS	-	FI-12 FI-12P FI-12P3 FI-3D FI-3DP3	FI-12 FI-12P FI-12P3 FI-3D FI-3DP3	FI-12 FI-12P FI-12P3 FI-3D FI-3DP3	FI-12 FI-12P FI-12P3 FI-3D FI-3DP3	
	SAXO	96	SIX-3P	SIX-3P	SIX-3P	SIX-3P	SIX-3P
	SM	70-	CT-3 CT-3P	RO-5D RO-5I	RO-5D RO-5I		LAS-V
	VISA	79-85	CHR-3	RO-4D	RO-4D	PJ-2	



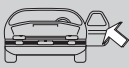



MARCA	MODELO						
			CHR-3P NE-22P1 NE-4 NE-4P1	RO-4I RO-5D RO-5I	RO-4I RO-5D RO-5I	PJ-2P PJ-K PJ-KP	
	VISA	85-	SIX-1 SIX-1KP SIX-1P	SIX-1 SIX-1KP SIX-1P	SIX-1 SIX-1KP SIX-1P	PJ-2 PJ-2P PJ-K PJ-KP SIX-1 SIX-1KP SIX-1P	
	XANTIA	93-	SIX-3P	SIX-3P	SIX-3P		
	XM	90-	SIX-3P	SIX-3P	SIX-3P		SIX-3P
	ZX	91-92	SIX-1 SIX-1KP SIX-1P	SIX-1 SIX-1KP SIX-1P	SIX-1 SIX-1KP SIX-1P	SIX-1 SIX-1KP SIX-1P	
	ZX	92-94	SIX-1KP SIX-1P2	SIX-1KP SIX-1P2	SIX-1KP SIX-1P2		SIX-1KP SIX-1P2
CHRYSLER	024	87-	CHR-8 CHR-8P	CHR-8 CHR-8P	CHR-8 CHR-8P		CHR-8 CHR-8P
	5.TH AVENUE LEBARON NEW YORKER	- 89- -	CHR-8 CHR-8P	CHR-8 CHR-8P	CHR-13D		CHR-13D
	ARROW PICK UP	- -	MIT-1I MIT-1IP	MIT-1I MIT-1IP	MIT-1I MIT-1IP	MIT-1I MIT-1IP	MIT-1I MIT-1IP
	COLT VISTA	93- 93-	MIT-8D MIT-8DP	MIT-8D MIT-8DP	MIT-8D MIT-8DP		MIT-8D MIT-8DP
	CONCORDE FULL SIZE V. IMPERIAL NEW YORKER PICK UP TOWN & CO. VANS	93- 93- 93- 93- 93- -	CHR-10 CHR-10P	CHR-10 CHR-10P	CHR-10 CHR-10P		CHR-10 CHR-10P
	CONQUEST CHALLENGER RAIDER SAPPORO	- - - -	MIT-2I MIT-2IP	MIT-2I MIT-2IP	MIT-2I MIT-2IP	MIT-2I MIT-2IP	MIT-2I MIT-2IP
	CRICKET	-	LF-SL LF-SLP	LF-SL LF-SLP			
	D 50	-	MIT-1I MIT-1IP	MIT-1I MIT-1IP	LF-6 MIT-1I MIT-1IP	MIT-1I MIT-1IP	LF-6 MIT-1I MIT-1IP
	FULL SIZE V.	-	CHR-8	CHR-8	CHR-8		CHR-13D

MARCA	MODELO						
			CHR-8P	CHR-8P	CHR-8P		
	GR. VOYAGER STRATUS VIPER VISION VOYAGER	96-97 95 95 95 95	CHR-14 CHR-14P CHR-15 CHR-15P	CHR-14 CHR-14P CHR-15 CHR-15P	CHR-14 CHR-14P CHR-15 CHR-15P		CHR-14 CHR-14P CHR-15 CHR-15P
	LEBARON VAN. MOD. USA OMNI-HORIZON RELIANT TC3-ARIES	- 80-86 - 89- -	CHR-7 CHR-7P	CHR-7 CHR-7P	CHR-13D CHR-7 CHR-7P		CHR-13D CHR-7 CHR-7P
	MOD. USA	67-79	CHR-7 CHR-7P	CHR-7 CHR-7P	CHR-13D		CHR-13D
	MOD. USA	90-92			CHR-13D		
CHRYSLER (DODGE)	1800	-			CHR-12	WAS-1	
	400	85-	CHR-7 CHR-7P	CHR-7 CHR-7P	CHR-12		CHR-12
	600 CARAVEL. LANCER	85-89 -	CHR-8 CHR-8P	CHR-8 CHR-8P	CHR-13D		CHR-13D
	CARAVAN	91-93	CHR-8 CHR-8P	CHR-8 CHR-8P	CHR-8 CHR-8P		
	CARAVAN DAKOTA DAYTONA INTREPID RAMCHARGER SPIRIT VIPER	93- 93- 93- 93- 93- 93- 93-	CHR-10 CHR-10P	CHR-10 CHR-10P	CHR-10 CHR-10P		CHR-10 CHR-10P
	COLT VISTA	89-93 89-92	CHR-17 MIT-12 MIT-7 MIT-7P	CHR-17 MIT-12 MIT-7 MIT-7P	MIT-12 MIT-7 MIT-7P		MIT-12 MIT-7 MIT-7P
	COLT VISTA	93- 93-	MIT-13D MIT-14D MIT-8D MIT-8DP	MIT-13D MIT-14D MIT-8D MIT-8DP	MIT-8D MIT-8DP		MIT-8D MIT-8DP
	DAKOTA DAYTONA	91-93 91-93	CHR-8 CHR-8P	CHR-8 CHR-8P	CHR-8 CHR-8P		CHR-13D
	DODGE RAM 50	85-86 -	CHR-7 CHR-7P	CHR-7 CHR-7P			
	DODGE RAM TRAIL, DUSTER	86-90 86- 86-	CHR-8 CHR-8P	CHR-8 CHR-8P			



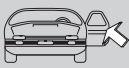



MARCA	MODELO						
	DODGE SPIRIT	91-90-92	CHR-9 CHR-9P	CHR-9 CHR-9P	CHR-9 CHR-9P		CHR-9 CHR-9P
	DODGE	-	CHR-7 CHR-7P CHR-8 CHR-8P	CHR-7 CHR-7P CHR-8 CHR-8P			
	DODGE 400	89-	CHR-7 CHR-7P				
	DODGE 600	89-	CHR-8 CHR-8P				
	MONACO	90-93		VA-10	VA-10		VA-10
	NEON	95	CHR-9 CHR-9P	CHR-9 CHR-9P	CHR-9 CHR-9P	CHR-9 CHR-9P	CHR-9 CHR-9P
	RAMCHARGER	81-92	CHR-7 CHR-7P CHR-8 CHR-8P	CHR-7 CHR-7P CHR-8 CHR-8P	CHR-8 CHR-8P		CHR-8 CHR-8P
	SHADOW ES	91-92	CHR-8 CHR-8P	CHR-8 CHR-8P	CHR-8 CHR-8P		CHR-8 CHR-8P
	STEALTH	91-93	MIT-12 MIT-7 MIT-7P	MIT-12 MIT-7 MIT-7P	MIT-12 MIT-7 MIT-7P		MIT-12 MIT-7 MIT-7P
	VIPER	90-92	CHR-9 CHR-9P	CHR-9 CHR-9P	CHR-13D CHR-9 CHR-9P		CHR-9 CHR-9P
CHRYSLER (EAGLE)	D 50	-	MIT-11	MIT-11	LF-6		LF-6
	EAGLE	89-90	MIT-12 MIT-7 MIT-7P	MIT-12 MIT-7 MIT-7P	MIT-12 MIT-7 MIT-7P		MIT-12 MIT-7 MIT-7P
	EAGLE PREMIER	90-92 90-		VA-10	VA-10		
	EAGLE	93-	MIT-8D MIT-8DP	MIT-8D MIT-8DP	MIT-8D MIT-8DP		MIT-8D MIT-8DP
	EAGLE MEDALLION	- -	NE-19 NE-19P	NE-28 VA-10	NE-28 VA-10		
	SUMMIT TALON	89-92 89-	CHR-17 MIT-12 MIT-7 MIT-7P	CHR-17 MIT-12 MIT-7 MIT-7P	MIT-12 MIT-7 MIT-7P		MIT-12 MIT-7 MIT-7P
	SUMMIT	93-	MIT-13D MIT-14D MIT-8D	MIT-13D MIT-14D MIT-8D	MIT-8D MIT-8DP		MIT-8D MIT-8DP

MARCA	MODELO						
			MIT-8DP	MIT-8DP			
	VISION	93-98	CHR-10 CHR-10P	CHR-10 CHR-10P	CHR-10 CHR-10P		CHR-10 CHR-10P
CHRYSLER (PLYMOUTH)	ACCLAIM PLYMOUTH	90-92 90-	CHR-9 CHR-9P	CHR-9 CHR-9P	CHR-9 CHR-9P		CHR-9 CHR-9P
	ACCLAIM GRAN VOYAGER VOYAGER	93- 93- 93-	CHR-10 CHR-10P	CHR-10 CHR-10P	CHR-10 CHR-10P		CHR-10 CHR-10P
	COLT VISTA LASER	89-92 89-92	CHR-17	CHR-17			
	COLT VISTA	93-94	MIT-13D MIT-14D	MIT-13D MIT-14D			
	NEON	95	CHR-14 CHR-14P CHR-15 CHR-15P	CHR-14 CHR-14P CHR-15 CHR-15P	CHR-14 CHR-14P CHR-15 CHR-15P		CHR-14 CHR-14P CHR-15 CHR-15P
	PLIMOUTH	85-86	CHR-7 CHR-7P	CHR-7 CHR-7P			
	PLIMOUTH	86-90	CHR-8 CHR-8P	CHR-8 CHR-8P			
	SUNDANCE	89-	CHR-8 CHR-8P	CHR-8 CHR-8P	CHR-13D		CHR-13D
	VOYAGER	91-92	CHR-8 CHR-8P	CHR-8 CHR-8P	CHR-8 CHR-8P		CHR-13D
DAEWOO	DAMA	-	DAE-1P	DAE-1P	DAE-1P	DAE-1P	DAE-1P
	LANOS	97	DAE-4P1	DAE-4P1	DAE-4P1	DAE-4P1	
	LE MANS	73-82	OP-6 OP-7 OP-8 OP-9 OP-BB OP-EE OP-FF	OP-6 OP-7 OP-8 OP-9 OP-BB OP-EE OP-FF	OP-6 OP-7 OP-8 OP-9 OP-BB OP-EE OP-FF		
	LE MANS	83-84	OP-D OP-DKP OP-DP OP-S OP-SKP OP-SP	OP-D OP-DKP OP-DP OP-S OP-SKP OP-SP	OP-D OP-DKP OP-DP OP-S OP-SKP OP-SP	OP-D OP-DKP OP-DP OP-S OP-SKP OP-SP	
	LE MANS	85-	OP-AB OP-ABP OP-BA OP-BAP	OP-AB OP-ABP OP-BA OP-BAP	OP-AB OP-ABP OP-BA OP-BAP	OP-AB OP-ABP OP-BA OP-BAP	



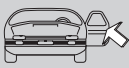

MARCA	MODELO						
			OP-J OP-JP	OP-J OP-JP	OP-J OP-JP	OP-J OP-JP	
	LEGANZA	97	DAE-4DP1	DAE-4DP1	DAE-4DP1	DAE-4DP1	
	NUBIRA	97	DAE-3DP1	DAE-3DP1	DAE-3DP1	DAE-3DP1	
	RACER	-	DAE-2DP	DAE-2DP	DAE-2DP	DAE-2DP	DAE-2DP
DAF	46 L	-		FO-TC	FO-TC	PJ-1	
	46 STATIONCA	-					
	46 SUPER L	-					
	66 GL	-					
DAF	66 COUPE	-				PJ-1	
	66 L	-					
	66 MARATHON	-					
	66 SL	-					
DAF	66 STATIONCA	-					
	95 XF	97	CHR-3P	CHR-3P	CHR-3P		CHR-3P
	4 WD TURBO	-	TOYO-K1		TOYO-K1	TOYO-K1	TOYO-K1
	PIONEER 2800	-	TOYO-K1P		TOYO-K1P	TOYO-K1P	TOYO-K1P
DAIHATSU	TAFT 1600 D.	-					
	TAFT F10	-					
	TAFT F20	-					
	TAFT F201600	-					
	TAFT F50	-					
	TAFT F55	-					
	APPLAUSE	90-	DAI-1P	DAI-1P	DAI-1P	DAI-1P	DAI-1P
	CHARADE	90-					
ROCKY	90-						
DAIHATSU	CUORE 850	86-91	TOYO-3 TOYO-3P	TOYO-3 TOYO-3P	TOYO-3 TOYO-3P	TOYO-3 TOYO-3P	TOYO-3 TOYO-3P
	CUORE L55	76-98	TOYO-K1	TOYO-K1	TOYO-K1		
DAIHATSU	CUORE L60	76-98	TOYO-K1P	TOYO-K1P	TOYO-K1P		
	MIRA	76-					
DAIHATSU	CHARADE	77-83	TOYO-K1	TOYO-K1	TOYO-K1	TOYO-K1	TOYO-K1
	CHARMANT	83-	TOYO-K1P	TOYO-K1P	TOYO-K1P	TOYO-K1P	TOYO-K1P
DAIHATSU	CHARADE	83-89	TOYO-3 TOYO-3P TOYO-8 TOYO-8P	TOYO-3 TOYO-3P TOYO-8 TOYO-8P	TOYO-3 TOYO-3P TOYO-8 TOYO-8P	TOYO-3 TOYO-3P TOYO-8 TOYO-8P	TOYO-3 TOYO-3P TOYO-8 TOYO-8P
	FEROZA	88-	DAI-1P	DAI-1P	DAI-1P		DAI-1P
	SPORTTRACK	91-					
DAIHATSU	SX 228	91-					
	FOURTRAK 4WD	84-88	TOYO-3 TOYO-3P TOYO-8 TOYO-8P	TOYO-3 TOYO-3P TOYO-8 TOYO-8P	TOYO-8 TOYO-8P		TOYO-8 TOYO-8P
DAIHATSU	ROCKY	84-88					

MARCA	MODELO						
	ROCKY	89-90	TOYO-3 TOYO-3P	TOYO-3 TOYO-3P	TOYO-3 TOYO-3P		TOYO-3 TOYO-3P
DAIMLER	DOUBLE SIX C LIMOUSINE SOVEREIGN V. SOVEREIGN3.4 SOVEREIGN4.2	-87 -87 -87 -87 -87	FO-FR FO-FRP	CENT-3D FO-5	CENT-3D FO-5	CENT-3D FO-5 FO-TC	CENT-3D FO-5 FO-TC
	MODELOS	90-94	JAU-1P	JAU-1P	JAU-1P	JAU-1P	JAU-1P
DE LOREAN	MODELOS	80-81	NE-10 NE-10P	LF-WR	NE-10 NE-10P		
DELTA MOTOR	CRUISER MINI WHEEL	- -	TOYO-K1 TOYO-K1P	TOYO-K1 TOYO-K1P			
	EXPLORER	-	TOYO-K1 TOYO-K1P	DAT-6 DAT-6P	DAT-6 DAT-6P		
DISALCAR	IN 32 4X4 IN 50 R 4X4 IN 60 4X4 IN 70 B 4X4 IN 70 CR 4X4	- - - - -	AF-7I AF-7IP	IMS-3 IMS-3P IMS-5 IMS-5P		AF-5D	
	R 26 4x4	-	BH-4				
EBRO	F 275 F 350	- -	LMP-1 LMP-1P STS-2D STS-2DP	IMS-3 IMS-3P IMS-5 IMS-5P	IMS-3 IMS-3P IMS-5 IMS-5P		
	L 35 L 35/1 L 60 L 80	- - - -	LMP-1 LMP-1P NE-3 NE-3P NE-3P1 NE-3P2	CL-2I CL-3I FO-OA FO-PN	CL-2I CL-3I FO-OA FO-PN PJ-2 PJ-2P		
	PATROL	83-	DAT-6 DAT-6P	DAT-6 DAT-6P	DAT-6 DAT-6P	DAT-6 DAT-6P	DAT-6 DAT-6P
	TRADE 2.0 TRADE 2.8	83- 83-	STS-2D STS-2DP	IMS-3 IMS-3P IMS-5 IMS-5P	IMS-3 IMS-3P IMS-5 IMS-5P		
	VANETTE	83-	DAT-6 DAT-6P	DAT-6 DAT-6P	DAT-6 DAT-6P		
FERRARI	208 308 365 DINO 246	75-82 73-75 68- -	NE-25	IMS-3 IMS-3P IMS-5 IMS-5P	IMS-3 IMS-3P IMS-5 IMS-5P		
	208	82-	NE-25	AF-5D	AF-5D	FAR-1D	







MARCA	MODELO						
	308 328	75- 85-		AF-5I AF-6D AF-6I	AF-5I AF-6D AF-6I	FAR-1I	
	208 GTS	82	AF-7IP1				
	348 F 40 MONDIAL TESTA ROSSA	84- 84- 84- 84-	FI-6I FI-6IP FI-6IP2 FI-6IP3	FI-6I FI-6IP FI-6IP2 FI-6IP3	FI-6I FI-6IP FI-6IP2 FI-6IP3	AF-5D	
	400 412 BB 512	76- 76- 76-	HU-1 NE-25	AF-5D AF-5I AF-6D AF-6I	AF-5D AF-5I AF-6D AF-6I	FAR-1D FAR-1I	
	GTO	84	NE-25	AF-6D	AF-6D		
	MONDIAL 8	82	AF-7I AF-7IP AF-7IP1	AF-5D AF-5I AF-6D AF-6I	AF-5D AF-5I AF-6D AF-6I		
FIAT	124	66-	AF-7I AF-7IP AF-9D AF-9DP FEM-1D FEM-1I FEM-2D FEM-2I FO-FR FO-FRP SIP-2	IMS-3 IMS-3P IMS-5 IMS-5P	IMS-3 IMS-3P IMS-5 IMS-5P		
	125	-	AF-7I AF-7IP AF-9D AF-9DP FO-FR FO-FRP	IMS-3 IMS-3P IMS-5 IMS-5P	IMS-3 IMS-3P IMS-5 IMS-5P		
	126	-	AF-7I AF-7IP AF-9D AF-9DP FI-3D FI-3DP2 FI-9I FI-9IP FO-FR FO-FRP SIP-3	IMS-3 IMS-3P IMS-5 IMS-5P	IMS-3 IMS-3P IMS-5 IMS-5P		
	126 BIS 126 UP	87-92 87-92	FI-3D FI-3DP2 FI-3DP3 FI-6I	IMS-3 IMS-3P IMS-5 IMS-5P	IMS-3 IMS-3P IMS-5 IMS-5P		

MARCA	MODELO						
			FI-6IP2				
	127	73-	AF-7I AF-7IP FI-8I FI-8IP FI-9I FI-9IP FO-FR FO-FRP SIP-3	IMS-3 IMS-3P IMS-5 IMS-5P	IMS-3 IMS-3P IMS-5 IMS-5P	AF-5D FIA-2 IMS-12 IMS-5 IMS-5P	
	127	83-	AF-7IP1 FI-8IP1				
	128	69-	AF-7I AF-7IP AF-9D AF-9DP FI-9I FI-9IP FO-FR FO-FRP SIP-2 SIP-3	IMS-3 IMS-3P IMS-5 IMS-5P	IMS-3 IMS-3P IMS-5 IMS-5P	IMS-3 IMS-3P IMS-5 IMS-5P	
	130	69-	AF-7I AF-7IP SIP-3	IMS-3 IMS-3P IMS-5 IMS-5P	IMS-3 IMS-3P IMS-5 IMS-5P		
	131	73-80	AF-7I AF-7IP AF-8I AF-8IP AF-9I AF-9IP	IMS-3 IMS-3P IMS-5 IMS-5P	IMS-3 IMS-3P IMS-5 IMS-5P	IMS-3 IMS-3P IMS-5 IMS-5P	
	131	81-	FI-2D FI-2DP3 FI-3D FI-3DP2 FI-6I FI-6IP	FI-3D FI-3DP2 FI-6I FI-6IP	FI-3D FI-3DP2 FI-6I FI-6IP	IMS-12	
	132	73-	AF-7I AF-7IP FI-8I FI-8IP	IMS-3 IMS-3P IMS-5 IMS-5P	IMS-3 IMS-3P IMS-5 IMS-5P		
	147	76-	FI-8I FI-8IP FI-8IP1 FI-9I FI-9IP	IMS-3 IMS-3P IMS-5 IMS-5P	IMS-3 IMS-3P IMS-5 IMS-5P	FIA-2 IMS-12 IMS-3 IMS-3P IMS-5 IMS-5P	
	148	76-	FI-8I	IMS-3	IMS-3	FIA-2	



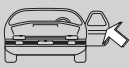



MARCA	MODELO						
			FI-8IP FI-8IP1 FI-9I FI-9IP	IMS-3P IMS-5 IMS-5P	IMS-3P IMS-5 IMS-5P	IMS-3 IMS-3P IMS-5 IMS-5P	
	500	64-	AF-9D AF-9DP FEM-1D FEM-1I FEM-2D FEM-2I FO-FR FO-FRP	AF-5D AF-5I AF-6D AF-6I			
	600	55-	FEM-1D FEM-1I FEM-2D FEM-2I	AF-5D AF-5I AF-6D AF-6I			
	850	64-	AF-7I AF-7IP FEM-1D FEM-1I FEM-2D FEM-2I FO-FR FO-FRP NE-3 NE-3P NE-3P2	AF-5D AF-5I AF-6D AF-6I			
	1100	56-	FEM-1D FEM-1I FEM-2D FEM-2I	AF-4D AF-4I AF-5D AF-5I AF-6D AF-6I	AF-4D AF-4I AF-5D AF-5I AF-6D AF-6I		
	1300	-	FEM-1D FEM-1I FEM-2D FEM-2I	AF-5D AF-5I AF-6D AF-6I	AF-5D AF-5I AF-6D AF-6I		
	1500	67-	FEM-1D FEM-1I FEM-2D FEM-2I SIP-2	AF-5D AF-5I AF-6D AF-6I	AF-5D AF-5I AF-6D AF-6I		
	1800 2100 2300	67- 67- 67-	SIP-2	AF-5D AF-5I AF-6D AF-6I	AF-5D AF-5I AF-6D AF-6I		
	ARGENTIA	81-	FI-2D FI-2DP3 FI-3D FI-3DP2	FI-2D FI-2DP3 FI-3D FI-3DP2	FI-2D FI-2DP3 FI-3D FI-3DP2	FI-2D FI-2DP3 FI-3D FI-3DP2	

MARCA	MODELO						
	CINQUECENTO	92-97	FI-11 FI-11KP FI-11P	FI-11 FI-11KP FI-11P	FI-11 FI-11KP FI-11P	FI-11 FI-11KP FI-11P	
	COUPE	94-95	FI-13 FI-13P	FI-13 FI-13P	FI-13 FI-13P	FI-13 FI-13P	FI-13 FI-13P
	CROMA	85-95	FI-10 FI-10P FI-11 FI-11KP FI-11P	FI-11 FI-11KP FI-11P	FI-11 FI-11KP FI-11P		FI-11 FI-11KP FI-11P
	DINO	-	FO-FR FO-FRP SIP-2	IMS-3 IMS-3P IMS-5 IMS-5P	IMS-3 IMS-3P IMS-5 IMS-5P		
	DUCATO	94	FI-11 FI-11KP FI-11P	FI-11 FI-11KP FI-11P	FI-11 FI-11KP FI-11P		
	DUNA	87-91	FI-1 FI-1P	FI-1 FI-1P	FI-1 FI-1P	FI-1 FI-1P IMS-12	
	DUNA	92-	FI-1 FI-11 FI-11KP FI-11P FI-1P	FI-1 FI-11 FI-11KP FI-11P FI-1P	FI-1 FI-11 FI-11KP FI-11P FI-1P	IMS-3 IMS-3P IMS-5 IMS-5P	
	FIORINO	-	AF-7I AF-7IP AF-9D AF-9DP AF-9I AF-9IP FI-8I FI-8IP FI-9I FI-9IP	IMS-3 IMS-3P IMS-5 IMS-5P	IMS-3 IMS-3P IMS-5 IMS-5P	IMS-3 IMS-3P IMS-5 IMS-5P	
	PANDA	80-85	FI-7I FI-8I FI-8IP FI-8IP1 FI-9I FI-9IP	IMS-3 IMS-3P IMS-5 IMS-5P	IMS-3 IMS-3P IMS-5 IMS-5P	IMS-12	
	PANDA	86-91	FI-1 FI-1P	FI-1 FI-1P	FI-1 FI-1P	FI-1 FI-1P	
	PANDA	92-95	FI-1 FI-11 FI-11KP FI-11P	FI-1 FI-11 FI-11KP FI-11P	FI-1 FI-11 FI-11KP FI-11P		



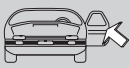



MARCA	MODELO						
			FI-1P	FI-1P	FI-1P		
	PUNTO	93-95	FI-13 FI-13P1	FI-13 FI-13P1	FI-13 FI-13P1	FI-13 FI-13P1	
	REGATA	83-	FI-1 FI-10 FI-10P FI-11 FI-11KP FI-11P FI-1P	FI-1 FI-11 FI-11KP FI-11P FI-1P	FI-1 FI-11 FI-11KP FI-11P FI-1P	FI-1 FI-11 FI-11KP FI-11P FI-1P	
	RITMO	78-83	FI-3D FI-3DP FI-3DP2 FI-6I FI-6IP	FI-3D FI-3DP FI-3DP2 FI-6I FI-6IP	FI-3D FI-3DP FI-3DP2 FI-6I FI-6IP	FAB-2 FI-3D FI-3DP FI-3DP2 FI-6I FI-6IP	
	RITMO STRADA	84-86 84-86	FI-1 FI-1P	FI-1 FI-1P	FI-1 FI-1P	FI-1 FI-1P SI-2D SI-3D	
	SCUDO ULYSSE	95-97 94	SIX-3P1	SIX-3P1	SIX-3P1		SIX-3P1
	SPIDER EURO.	-	AF-7I AF-7IP	AF-5D AF-5I AF-6D AF-6I	AF-5D AF-5I AF-6D AF-6I		
	STRADA	79-82	FI-7I FI-8I FI-8IP	FI-7I FI-8I FI-8IP	FI-7I FI-8I FI-8IP	FI-7I FI-8I FI-8IP	FI-7I FI-8I FI-8IP
	STRADA	82-84	FI-3D FI-3DP FI-6I FI-6IP	FI-3D FI-3DP FI-6I FI-6IP	FI-3D FI-3DP FI-6I FI-6IP	FI-3D FI-3DP FI-6I FI-6IP	FI-3D FI-3DP FI-6I FI-6IP
	TEMPRA	89-95	FI-13 FI-13P FI-14P	FI-13 FI-13P FI-14P	FI-13 FI-13P FI-14P	FI-13 FI-13P FI-14P	FI-13 FI-13P FI-14P
	TIPO	88-	FI-13 FI-13P	FI-13 FI-13P	FI-13 FI-13P	FI-13 FI-13P	
	UNO	83-	FI-1 FI-11 FI-11KP FI-11P FI-1P	FI-1 FI-11 FI-11KP FI-11P FI-1P	FI-1 FI-11 FI-11KP FI-11P FI-1P	FI-1 FI-11 FI-11KP FI-11P FI-1P IMS-12 SI-2D SI-3D	

MARCA	MODELO						
	X 1/9	72-	AF-7I AF-7IP	IMS-3 IMS-3P IMS-5 IMS-5P	IMS-3 IMS-3P IMS-5 IMS-5P		
FIAT IVECO	131 D MAR.	76-	AF-7I AF-7IP	IMS-3 IMS-3P IMS-5 IMS-5P	IMS-3 IMS-3P IMS-5 IMS-5P		
	180 190	-89 -89				IMS-12	
	238	-	AF-7I AF-7IP AF-9D AF-9DP AF-9I AF-9IP	AF-5D AF-5I AF-6D AF-6I	AF-5D AF-5I AF-6D AF-6I		
	900 E	80-	FI-8I FI-8IP	AF-5D AF-5I AF-6D AF-6I			
	900 T	76-	AF-7I AF-7IP AF-8D AF-8DP AF-8I AF-8IP AF-9D AF-9DP AF-9I AF-9IP	AF-5D AF-5I AF-6D AF-6I	AF-5D AF-5I AF-6D AF-6I		
	DAILY 30 DAILY 35 DAILY 40 DAILY 50	-84 -84 -84 -84	AF-7I AF-7IP FI-9I FI-9IP	IMS-3 IMS-3P IMS-5 IMS-5P	IMS-3 IMS-3P IMS-5 IMS-5P		
	DAILY 30 DAILY 35 DAILY 40 DAILY 50	85-88 85-88 85-88 85-88	FI-2D FI-2DP3 FI-3D FI-3DP1 FI-6I FI-6IP1	FI-2D FI-2DP3 FI-3D FI-3DP1 FI-6I FI-6IP1	FI-2D FI-2DP3 FI-3D FI-3DP1 FI-6I FI-6IP1		FIS-1D
	DAILY 30 DAILY 35 DAILY 40 DAILY 45 DAILY 49 DAILY 50	89-91 89-91 89-91 89-91 89-91 89-91	FI-11 FI-11KP FI-11P	FI-11 FI-11KP FI-11P	FI-11 FI-11KP FI-11P		FIS-1D
	DUCATO 10 DUCATO 13 DUCATO MAXI	-88 -88 -88	FI-12 FI-12P1 FI-12P3	FI-12 FI-12P1 FI-12P3	FI-12 FI-12P1 FI-12P3		



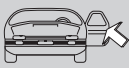



MARCA	MODELO						
			FI-3D FI-3DP3 FI-6I FI-6IP3	FI-3D FI-3DP3 FI-6I FI-6IP3	FI-3D FI-3DP3 FI-6I FI-6IP3		
	DUCATO 10 DUCATO 14 DUCATO 4x4 DUCATO MAX	89-96 89-96 89-96 89-96	FI-3D FI-3DP3 FI-6I FI-6IP3	FI-3D FI-3DP3 FI-6I FI-6IP3	FI-3D FI-3DP3 FI-6I FI-6IP3		
	FIORINO	-82	AF-9D AF-9DP AF-9I AF-9IP FI-9I FI-9IP	IMS-3 IMS-3P IMS-5 IMS-5P	IMS-3 IMS-3P IMS-5 IMS-5P		
	FIORINO	83-87	AF-7I AF-7IP FI-8IP1 FI-9I FI-9IP	IMS-3 IMS-3P IMS-5 IMS-5P		IMS-12 IMS-3 IMS-3P IMS-5 IMS-5P	
	FIORINO PENNY	88-96 -91	FI-11 FI-11KP FI-11P	FI-11 FI-11KP FI-11P	FI-11 FI-11KP FI-11P	IMS-12 IMS-3 IMS-3P IMS-5 IMS-5P	
	MARENGO R. PANDA UNO	85-96 -94 -91	FI-11 FI-11KP FI-11P	FI-11 FI-11KP FI-11P	FI-11 FI-11KP FI-11P		
	TALENTO	-	FI-6I FI-6IP	FI-6I FI-6IP	FI-6I FI-6IP	FI-6I FI-6IP	FI-6I FI-6IP
FIAT (ARGENTINA)	128	-	NE-4 NE-4P	NE-46	NE-46		
	133	-	NE-3 NE-3P NE-3P2		NE-3 NE-3P NE-3P2		
	147	-	NE-4 NE-4P				
	600	-	NE-3 NE-3P NE-3P2				
	DUNA	87-91	FI-1 FI-1P	FI-1 FI-1P	FI-1 FI-1P	FI-1 FI-1P	
	DUNA	92-	FI-1 FI-11 FI-11KP FI-11P FI-1P	FI-1 FI-11 FI-11KP FI-11P FI-1P	FI-1 FI-11 FI-11KP FI-11P FI-1P	IMS-3 IMS-3P IMS-5 IMS-5P	

MARCA	MODELO						
	REGATTA	83-	FI-1 FI-10 FI-10P FI-11 FI-11KP FI-11P FI-1P	FI-1 FI-11 FI-11KP FI-11P FI-1P	FI-1 FI-11 FI-11KP FI-11P FI-1P NE-53	FI-1 FI-11 FI-11KP FI-11P FI-1P	
	SPAZIO	-	AF-7I AF-7IP FI-8I FI-8IP FI-9I FI-9IP FO-FR FO-FRP SIP-3	IMS-3 IMS-3P IMS-5 IMS-5P	IMS-3 IMS-3P IMS-5 IMS-5P	AF-5D IMS-5 IMS-5P	
	TEMPRA	-	FI-13 FI-13P	FI-13 FI-13P	FI-13 FI-13P		
	UNO	83-	FI-1 FI-11 FI-11KP FI-11P FI-1P	FI-1 FI-11 FI-11KP FI-11P FI-1P	FI-1 FI-11 FI-11KP FI-11P FI-1P	FI-1 FI-11 FI-11KP FI-11P FI-1P SI-2D SI-3D	
FIAT (BRASIL)	ELBA PREMIO	92- 92-	FI-1 FI-11 FI-11KP FI-11P FI-1P	FI-1 FI-11 FI-11KP FI-11P FI-1P	FI-1 FI-11 FI-11KP FI-11P FI-1P	IMS-12 IMS-3 IMS-3P IMS-5 IMS-5P	
	PALIO	96-97	FI-13P7	FI-13P7	FI-13P7	FI-13P7	FI-13P7
	UNO	83-	FI-1 FI-11 FI-11KP FI-11P FI-1P	FI-1 FI-11 FI-11KP FI-11P FI-1P	FI-1 FI-11 FI-11KP FI-11P FI-1P	FI-1 FI-11 FI-11KP FI-11P FI-1P SI-2D SI-3D	
FIAT (TURQUIA)	131	73-80	AF-7I AF-7IP AF-8I AF-8IP AF-9I AF-9IP	IMS-3 IMS-3P IMS-5 IMS-5P	IMS-3 IMS-3P IMS-5 IMS-5P	IMS-3 IMS-3P IMS-5 IMS-5P	
	131	81-	FI-2D FI-2DP3 FI-3D FI-3DP2 FI-6I	FI-3D FI-3DP2 FI-6I FI-6IP	FI-3D FI-3DP2 FI-6I FI-6IP		



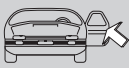



MARCA	MODELO						
			FI-6IP				
	SERCE	-	AF-7I AF-7IP AF-9D AF-9DP FEM-1D FEM-1I FEM-2D FEM-2I FO-FR FO-FRP SIP-2	IMS-3 IMS-3P IMS-5 IMS-5P	IMS-3 IMS-3P IMS-5 IMS-5P		
	TEMPRA	89-	FI-13 FI-13P FI-14P	FI-13 FI-13P FI-14P	FI-13 FI-13P FI-14P	FI-13 FI-13P FI-14P	FI-13 FI-13P FI-14P
FORD	CAPRI	-	FO-E/TC FO-E/TCP FO-TC FO-TX FO-TXKP FO-TXP	FO-E/TC FO-E/TCP FO-TC FO-TX FO-TXKP FO-TXP FO-XR	FO-E/TC FO-E/TCP FO-TC FO-TX FO-TXKP FO-TXP FO-XR	BL-2 FO-E/TC FO-E/TCP FO-TX FO-TXKP FO-TXP	FO-E/TC FO-E/TCP FO-TX FO-TXKP FO-TXP
	CARGO	87-90	NE-11 NE-11P	LF-WR	LF-WR		UN-FT
	CARGO	90-	NE-11 NE-11P	NE-11 NE-11P	NE-11 NE-11P		UN-FT
	CARGO	-	LF-WR NE-11 NE-11P NE-24 NE-24P	LF-WR	LF-WR		UN-FT
	CONSUL CORTINA	- -	FO-E/TC FO-E/TCP FO-TC	FO-E/TC FO-E/TCP FO-TC FO-XR	FO-E/TC FO-E/TCP FO-TC FO-XR		
	ESCORT	-86	FO-E/TC FO-E/TCP FO-TC FO-TX FO-TX1 FO-TX1P FO-TX2 FO-TX2P FO-TXKP FO-TXP	FO-E/TC FO-E/TCP FO-TC FO-TX FO-TX1 FO-TX1P FO-TX2 FO-TX2P FO-TXKP FO-TXP	FO-E/TC FO-E/TCP FO-TC FO-TX FO-TX1 FO-TX1P FO-TX2 FO-TX2P FO-TXKP FO-TXP	FO-E/TC FO-E/TCP FO-TX FO-TX1 FO-TX1P FO-TX2 FO-TX2P FO-TXKP FO-TXP	BL-2
	ESCORT GRANADA ORION SCORPIO	86-88 86- 86-88 86-88	FO-4P	FO-4P	FO-4P	FO-4P	

MARCA	MODELO						
	SIERRA	86-88					
	ESCORT FIESTA ORION SIERRA	89-95 88-95 88- 88-90	FO-6P	FO-6P	FO-6P	FO-6P	
	ESCORT VAN	-	FO-E/TC FO-E/TCP FO-TX FO-TXKP FO-TXP	FO-E/TC FO-E/TCP FO-TX FO-TXKP FO-TXP	FO-E/TC FO-E/TCP FO-TX FO-TXKP FO-TXP		
	FIESTA	-88	FO-E/TC FO-E/TCP FO-TC FO-TX FO-TX1 FO-TX1P FO-TX2 FO-TX2P FO-TXKP FO-TXP	FO-E/TC FO-E/TCP FO-TC FO-TX FO-TX1 FO-TX1P FO-TX2 FO-TX2P FO-TXKP FO-TXP	FO-E/TC FO-E/TCP FO-TC FO-TX FO-TX1 FO-TX1P FO-TX2 FO-TX2P FO-TXKP FO-TXP	AB-6I FO-E/TC FO-E/TCP FO-TX FO-TX1 FO-TX1P FO-TX2 FO-TX2P FO-TXKP FO-TXP	BL-2
	GRANADA	-86	FO-E/TC FO-E/TCP FO-TX FO-TX1 FO-TX1P FO-TX2 FO-TX2P FO-TXKP FO-TXP	FO-E/TC FO-E/TCP FO-TX FO-TX1 FO-TX1P FO-TX2 FO-TX2P FO-TXKP FO-TXP	FO-E/TC FO-E/TCP FO-TX FO-TX1 FO-TX1P FO-TX2 FO-TX2P FO-TXKP FO-TXP	FO-E/TC FO-E/TCP FO-TX FO-TX1 FO-TX1P FO-TX2 FO-TX2P FO-TXKP FO-TXP HA-1D HA-1I	BL-2
	MAVERICK	93-95	FO-10P	FO-10P	FO-10P	FO-10P	FO-10P
	MONDEO SCORPIO	93-95 90-95	FO-6P	FO-6P	FO-6P	FO-6P	FO-6P
	ORION SIERRA	-86 -86	FO-E/TC FO-E/TCP FO-TX FO-TX1 FO-TX1P FO-TX2 FO-TX2P FO-TXKP FO-TXP	FO-E/TC FO-E/TCP FO-TX FO-TX1 FO-TX1P FO-TX2 FO-TX2P FO-TXKP FO-TXP	FO-E/TC FO-E/TCP FO-TX FO-TX1 FO-TX1P FO-TX2 FO-TX2P FO-TXKP FO-TXP	FO-E/TC FO-E/TCP FO-TX FO-TX1 FO-TX1P FO-TX2 FO-TX2P FO-TXKP FO-TXP	BL-2
	PROBE	93-96	FO-9D FO-9DP	FO-9D FO-9DP	FO-9D FO-9DP		FO-9D FO-9DP
	SCORPIO	88-90	FO-6P	FO-6P	FO-6P	FO-6P	FO-TX FO-TXKP FO-TXP



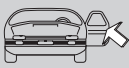



MARCA	MODELO						
	SIERRA	90-	FO-6P	FO-6P	FO-6P		FO-6P
	TAUNUS	-	FO-E/TC FO-E/TCP	FO-E/TC FO-E/TCP	FO-E/TC FO-E/TCP	HA-1D HA-1I	
	TRANSIT 100D	-	FO-TC	FO-PRL	FO-PRL		
	TRANSIT F	-86	FO-E/TC FO-E/TCP FO-TX FO-TX1 FO-TX1P FO-TX2 FO-TX2P FO-TXKP FO-TXP	UN-FT UN-TF	UN-FT UN-TF	UN-FT UN-TF	
	TRANSIT F	86-	FO-22P FO-4P	FO-22P FO-4P	FO-22P FO-4P	FO-22P FO-4P	
FORD (ARGENTINA)	ESCORT	-86	FO-E/TC FO-E/TCP FO-TC FO-TX FO-TX1 FO-TX1P FO-TX2 FO-TX2P FO-TXKP FO-TXP	FO-E/TC FO-E/TCP FO-TC FO-TX FO-TX1 FO-TX1P FO-TX2 FO-TX2P FO-TXKP FO-TXP	FO-E/TC FO-E/TCP FO-TC FO-TX FO-TX1 FO-TX1P FO-TX2 FO-TX2P FO-TXKP FO-TXP	FO-E/TC FO-E/TCP FO-TX FO-TX1 FO-TX1P FO-TX2 FO-TX2P FO-TXKP FO-TXP	BL-2
	ESCORT SIERRA	86-88 86-88	FO-4P	FO-4P	FO-4P	FO-4P	
	ESCORT SIERRA	88-95 88-90	FO-6P	FO-6P	FO-6P	FO-6P	
	ESCORT VAN	-	FO-E/TC FO-E/TCP FO-TX FO-TXKP FO-TXP	FO-E/TC FO-E/TCP FO-TX FO-TXKP FO-TXP	FO-E/TC FO-E/TCP FO-TX FO-TXKP FO-TXP		
	FALCON	-	FO-2	FO-2	FO-1	GAS-1	
	FIESTA MONDEO	95-96 95-96	FO-6P	FO-6P	FO-6P	FO-6P	FO-6P
	GALAXI	96	FO-17P	FO-17P	FO-17P		FO-17P
	GALAXY	-96	FO-FHP	FO-FHP	FO-FHP	FO-FHP	
			VO-3KP VO-HV VO-HVP	VO-3KP VO-HV VO-HVP	VO-3KP VO-HV VO-HVP	VO-3KP VO-HV VO-HVP	
	PICK UP	-93	FO-2	FO-2	FO-1		FO-1
	PICK UP	93-94	FO-3D	FO-3D		FO-3D	FO-3D

MARCA	MODELO						
			FO-3DP VO-3KP VO-HV VO-HVP	FO-3DP		FO-3DP	FO-3DP
	PICK-UP	95-96	FO-11D	FO-11D		FO-11D	FO-11D
	SIERRA	-86	FO-E/TC FO-E/TCP FO-TX FO-TX1 FO-TX1P FO-TX2 FO-TX2P FO-TXKP FO-TXP	FO-E/TC FO-E/TCP FO-TX FO-TX1 FO-TX1P FO-TX2 FO-TX2P FO-TXKP FO-TXP	FO-E/TC FO-E/TCP FO-TX FO-TX1 FO-TX1P FO-TX2 FO-TX2P FO-TXKP FO-TXP	FO-E/TC FO-E/TCP FO-TX FO-TX1 FO-TX1P FO-TX2 FO-TX2P FO-TXKP FO-TXP	BL-2
	SIERRA	90-	FO-6P	FO-6P	FO-6P		FO-6P
	TAUNUS	-	FO-TX FO-TXKP FO-TXP	FO-TX FO-TXKP FO-TXP	FO-TX FO-TXKP FO-TXP		
FORD (AUSTRALIA)	CAPRI	-78	FO-D FO-TC	FO-TC FO-XL	FO-TC FO-XL	FO-TC	FO-XR
	CAPRI	78-	FO-2 FO-TX FO-TXKP FO-TXP	FO-2 FO-TX FO-TXKP FO-TXP	FO-1 FO-TX FO-TXKP FO-TXP	FO-TX FO-TXKP FO-TXP	FO-TX FO-TXKP FO-TXP
	FESTIVA	93-94	KI-1D KI-1DP	KI-1D KI-1DP	KI-1D KI-1DP	KI-1D KI-1DP	KI-1D KI-1DP
	FESTIVA	94	FO-12 FO-12P	FO-12 FO-12P	FO-12 FO-12P	FO-12 FO-12P	FO-12 FO-12P
	LASER	88-90	FO-14DP	FO-14DP	FO-14DP	FO-14DP	FO-14DP
	LASER	90-93	FO-13DP	FO-13DP	FO-13DP	FO-13DP	FO-13DP
	TELSTAR	-	MAZ-2D MAZ-2DP	MAZ-2D MAZ-2DP	MAZ-2D MAZ-2DP	MAZ-2D MAZ-2DP	
FORD (BRASIL)	CORCEL DEL REY	- -	FO-3D FO-3DP	FO-3D FO-3DP	FO-3 FO-3P	FO-3 FO-3P	
	ESCORT	-86	FO-E/TC FO-E/TCP FO-TC FO-TX FO-TX1 FO-TX1P FO-TX2 FO-TX2P FO-TXKP FO-TXP	FO-E/TC FO-E/TCP FO-TC FO-TX FO-TX1 FO-TX1P FO-TX2 FO-TX2P FO-TXKP FO-TXP	FO-E/TC FO-E/TCP FO-TC FO-TX FO-TX1 FO-TX1P FO-TX2 FO-TX2P FO-TXKP FO-TXP	FO-E/TC FO-E/TCP FO-TX FO-TX1 FO-TX1P FO-TX2 FO-TX2P FO-TXKP FO-TXP	BL-2



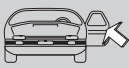



MARCA	MODELO						
	ESCORT	86-88	FO-4P	FO-4P	FO-4P	FO-4P	
	ESCORT	88-95	FO-6P	FO-6P	FO-6P	FO-6P	
	ESCORT VAN SIERRA VERONA	- - -	FO-E/TC FO-E/TCP FO-TX FO-TXKP FO-TXP	FO-E/TC FO-E/TCP FO-TX FO-TXKP FO-TXP	FO-E/TC FO-E/TCP FO-TX FO-TXKP FO-TXP		
	PICK-UP	95-96	FO-3P	FO-3P		FO-3P	FO-3P
	ARIOS	96-	FO-17P	FO-17P	FO-17P		FO-17P
	FORD (SOUTH AFRICA)	SAPPHIRE SIERRA	90- 90-	FO-6P	FO-6P	FO-6P	
SIERRA		-86	FO-E/TC FO-E/TCP FO-TX FO-TX1 FO-TX1P FO-TX2 FO-TX2P FO-TXKP FO-TXP	FO-E/TC FO-E/TCP FO-TX FO-TX1 FO-TX1P FO-TX2 FO-TX2P FO-TXKP FO-TXP	FO-E/TC FO-E/TCP FO-TX FO-TX1 FO-TX1P FO-TX2 FO-TX2P FO-TXKP FO-TXP	FO-E/TC FO-E/TCP FO-TX FO-TX1 FO-TX1P FO-TX2 FO-TX2P FO-TXKP FO-TXP	BL-2
SIERRA		86-88	FO-4P	FO-4P	FO-4P	FO-4P	
SIERRA		88-90	FO-6P	FO-6P	FO-6P	FO-6P	
FORD (USA)	AEROSTAR	86-91	FO-20D FO-8D	FO-20D FO-8D	FO-20D FO-8D		FO-1
	AEROSTAR EXPLORER TAURUS S. T-BIRD S.	91-96 91-96 91-96 91-	FO-11D	FO-1	FO-1	FO-1	
	AEROSTAR BRONCO PICK EXPLORER TAURUS TAURUS WAGON	96-97 96-97 96-97 96-97 96-97	FO-15D FO-15DP	FO-15D FO-15DP	FO-15D FO-15DP		FO-15D FO-15DP
	ASPIRE	94	FO-12 FO-12P	FO-12 FO-12P	FO-12 FO-12P		FO-12 FO-12P
	BRONCO CROWN MUSTANG T-BIRD VICTORIA	67-89 67-89 67-98 67-84 67-89	FO-2	FO-1	FO-1		FO-1
	CONCOURSE	95	FO-1	FO-1	FO-1		FO-1
	CONTOUR	95-97	FO-8D	FO-8D	FO-8D		FO-8D

MARCA	MODELO						
	CROWN SABLE TAURUS VICTORIA	90-98 90- 90-96 90-98	FO-11D FO-20D	FO-11D FO-20D	FO-1		FO-1
	ESCORT TEMPO GL TEMPO GLS	81-86 83-86 83-86	FO-2	FO-1	FO-1		
	ESCORT	90-95	FO-8D FO-8DP	FO-8D FO-8DP	FO-8D FO-8DP		FO-8D FO-8DP
	FESTIVA PROBE	87-89 87-89	MAZ-6D MAZ-6DP	MAZ-6D MAZ-6DP	MAZ-6D MAZ-6DP		MAZ-6D MAZ-6DP
	FESTIVA	90-	FO-14DP FO-7P				
	FIESTA	-79	FO-TC LF-SL	FO-TC LF-SL	FO-TC LF-SL		FO-TC LF-SL
	FIESTA MERKUR XR4 TI	79-84 85-89 85-89	FO-TX FO-TXKP FO-TXP	FO-TX FO-TXKP FO-TXP	FO-TX FO-TXKP FO-TXP		FO-TX FO-TXKP FO-TXP
	MERKUR PROBE	90-92 90-92	FO-14DP FO-7P	FO-14DP FO-7P	FO-14DP FO-7P		FO-14DP FO-7P
	PROBE	93-96	FO-9D FO-9DP	FO-9D FO-9DP	FO-9D FO-9DP		FO-9D FO-9DP
	SABLE TAUNUS	87-89 86-89	FO-8D FO-8DP	FO-8D FO-8DP	FO-1		FO-1
	SCORPIO	87	FO-22P FO-4P	FO-22P FO-4P	FO-22P FO-4P		FO-E/TC FO-E/TCP
	SCORPIO	88-	FO-6P	FO-6P	FO-6P		FO-E/TC FO-E/TCP
	TEMPO GL TEMPO GLS T-BIRD	86-91 86-91 86-91	FO-11D FO-20D	FO-11D FO-20D	FO-1	FO-1	
FORD (USA) (LINCOLN)	CONTINENTAL	67-84	FO-2	FO-1	FO-1		FO-1
	CONTINENTAL	85-91	FO-20D	FO-20D	FO-1		FO-1
	CONTINENTAL	91-98	FO-11D	FO-11D	FO-1		FO-1
	MARK SERIES	85-91	FO-11D FO-20D	FO-11D FO-20D	FO-1		FO-1
FORD (USA) (MERCURY)	CAPRI CAPRI	70-71 78-83	FO-D	FO-XL	FO-XL		FO-XL
	CAPRI	72-78	FO-E/TC FO-E/TCP	FO-E/TC FO-E/TCP	FO-E/TC FO-E/TCP		FO-E/TC FO-E/TCP



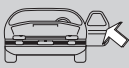



MARCA	MODELO						
			FO-TC	FO-TC	FO-TC		FO-TC
	CAPRI	83-91	FO-2	FO-2	FO-1	FO-1	
	CAPRI	91-	FO-14DP FO-7P	FO-14DP FO-7P			
	COUGAR MARQUIS	67-84 67-89	FO-2	FO-1	FO-1		FO-1
	COUGAR MARQUIS TOPAZ	90- 91- 90-	FO-11D FO-20D	FO-11D FO-20D	FO-1		FO-1
	G.MARQUIS MERCURY SABLE	93-98 93-96 93-96	FO-8D FO-8DP1	FO-8D FO-8DP1	FO-8D FO-8DP1		
	MERCURY	-93	FO-2	FO-2	FO-1		FO-1
	MYSTIQUE	95-97	FO-8D	FO-8D	FO-8D		FO-8D
	SABLE GS/LS	96-97	FO-15D FO-15DP	FO-15D FO-15DP	FO-15D FO-15DP		FO-15D FO-15DP
	TOPAZ	83-85	FO-2	FO-1	FO-1		
	TRACER	87-90	FO-14DP FO-7P	FO-14DP FO-7P	FO-14DP FO-7P		FO-14DP FO-7P
	TRACER	90-	FO-8D FO-8DP FO-8DP1	FO-8D FO-8DP FO-8DP1	FO-8D FO-8DP FO-8DP1		FO-8D FO-8DP FO-8DP1
FREIGHTLINER	MODELO	70	YA-8D	YA-8D	YA-8D	YA-8D	YA-8D
GM (BUICK)	3.8 PAVENUE LESABRE REATTA RIVIERA	92- 91-96 92- 92-95		GM-12 GM-12P GM-H GM-HP	GM-12 GM-12P GM-H GM-HP		GM-12 GM-12P GM-H GM-HP
	CENTURY MODELOS	91-97 81	GM-8 GM-8P GM-E GM-EP	GM-12 GM-12P GM-H GM-HP	GM-12 GM-12P GM-H GM-HP		GM-12 GM-12P GM-H GM-HP
	LESABRE ROADMASTER	96-97 96-97		GM-14 GM-14P GM-25 GM-25P	GM-14 GM-14P GM-25 GM-25P		GM-14 GM-14P GM-25 GM-25P
	MODELOS	35-66	BAS-1I	BAS-1I	BAS-1D		BAS-1D
	MODELOS MODELOS MODELOS MODELOS MODELOS	66 67 71 75 86	GM-6 GM-6P GM-A GM-AP	GM-6 GM-6P GM-A GM-AP	GM-10 GM-10P GM-B GM-BP		GM-10 GM-10P GM-B GM-BP

MARCA	MODELO						
	MODELOS MODELOS	68 72	GM-7 GM-7P GM-C GM-CP	GM-7 GM-7P GM-C GM-CP	GM-11 GM-11P GM-D GM-DP		GM-11 GM-11P GM-D GM-DP
	MODELOS MODELOS	69 73	GM-8 GM-8P GM-E GM-EP	GM-8 GM-8P GM-E GM-EP	GM-12 GM-12P GM-H GM-HP		GM-12 GM-12P GM-H GM-HP
	MODELOS MODELOS MODELOS	70 74 78	GM-9 GM-9P GM-J GM-JP	GM-9 GM-9P GM-J GM-JP	GM-13 GM-13P GM-K GM-KP		GM-13 GM-13P GM-K GM-KP
	MODELOS	76	GM-7 GM-7P GM-C GM-CP	GM-11 GM-11P GM-7 GM-7P GM-C GM-CP GM-D GM-DP	GM-11 GM-11P GM-D GM-DP		GM-11 GM-11P GM-D GM-DP
	MODELOS	77	GM-8 GM-8P GM-E GM-EP	GM-12 GM-12P GM-8 GM-8P GM-E GM-EP GM-H GM-HP	GM-12 GM-12P GM-H GM-HP		GM-12 GM-12P GM-H GM-HP
	MODELOS	79	GM-6 GM-6P GM-A GM-AP	GM-10 GM-10P GM-6 GM-6P GM-A GM-AP GM-B GM-BP	GM-10 GM-10P GM-B GM-BP		GM-10 GM-10P GM-B GM-BP
	MODELOS	80	GM-7 GM-7P GM-C GM-CP	GM-11 GM-11P GM-D GM-DP	GM-11 GM-11P GM-D GM-DP		GM-11 GM-11P GM-D GM-DP
	MODELOS	82	GM-9 GM-9P GM-J GM-JP	GM-13 GM-13P GM-K GM-KP	GM-13 GM-13P GM-K GM-KP		GM-13 GM-13P GM-K GM-KP
	MODELOS	83	GM-6 GM-6P GM-A GM-AP	GM-10 GM-10P GM-B GM-BP	GM-10 GM-10P GM-B GM-BP		GM-10 GM-10P GM-B GM-BP



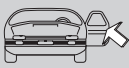



MARCA	MODELO						
	MODELOS MODELOS	84 85	GM-6 GM-6P GM-7 GM-7P GM-A GM-AP GM-C GM-CP	GM-10 GM-10P GM-7 GM-7P GM-B GM-BP GM-C GM-CP	GM-10 GM-10P GM-B GM-BP		GM-10 GM-10P GM-B GM-BP
	REGAL	88-90	GM-19P				
	REGAL	91-	GM-20P				
	RIVIERA SKYLARK	95 94	GM-14 GM-14P GM-25 GM-25P	GM-14 GM-14P GM-25 GM-25P	GM-14 GM-14P GM-25 GM-25P		GM-14 GM-14P GM-25 GM-25P
	RIVIERA 3.8V	89-90		GM-11 GM-11P GM-D GM-DP	GM-11 GM-11P GM-D GM-DP		GM-11 GM-11P GM-D GM-DP
	SKYLARK	92-93	GM-22 GM-22P GM-23 GM-23P	GM-22 GM-22P GM-23 GM-23P	GM-22 GM-22P GM-23 GM-23P		GM-22 GM-22P GM-23 GM-23P
GM (CADILLAC)	ALLANTE	87-88	GM-16P				
	BROUGHAM C.DE VILLE ELDORADO-TC FLEETWOOD SEVILLE	96-97 91- 91- 91- 91-		GM-12 GM-12P GM-H GM-HP	GM-12 GM-12P GM-H GM-HP		GM-12 GM-12P GM-H GM-HP
	ELDORADO-TC	89-90		GM-11 GM-11P GM-D GM-DP	GM-11 GM-11P GM-D GM-DP		GM-11 GM-11P GM-D GM-DP
	MODELOS	35-66	BAS-1I	BAS-1I	BAS-1D		BAS-1D
	MODELOS MODELOS MODELOS MODELOS MODELOS	66 67 71 75 86	GM-6 GM-6P GM-A GM-AP	GM-6 GM-6P GM-A GM-AP	GM-10 GM-10P GM-B GM-BP		GM-10 GM-10P GM-B GM-BP
	MODELOS MODELOS	68 72	GM-7 GM-7P GM-C GM-CP	GM-7 GM-7P GM-C GM-CP	GM-11 GM-11P GM-D GM-DP		GM-11 GM-11P GM-D GM-DP
	MODELOS MODELOS	69 73	GM-8 GM-8P GM-E GM-EP	GM-8 GM-8P GM-E GM-EP	GM-12 GM-12P GM-H GM-HP		GM-12 GM-12P GM-H GM-HP

MARCA	MODELO						
	MODELOS MODELOS MODELOS	70 74 78	GM-9 GM-9P GM-J GM-JP	GM-9 GM-9P GM-J GM-JP	GM-13 GM-13P GM-K GM-KP		GM-13 GM-13P GM-K GM-KP
	MODELOS	76	GM-7 GM-7P GM-C GM-CP	GM-11 GM-11P GM-7 GM-7P GM-C GM-CP GM-D GM-DP	GM-11 GM-11P GM-D GM-DP		GM-11 GM-11P GM-D GM-DP
	MODELOS	77	GM-8 GM-8P GM-E GM-EP	GM-12 GM-12P GM-8 GM-8P GM-E GM-EP GM-H GM-HP	GM-12 GM-12P GM-H GM-HP		GM-12 GM-12P GM-H GM-HP
	MODELOS	79	GM-6 GM-6P GM-A GM-AP	GM-10 GM-10P GM-6 GM-6P GM-A GM-AP GM-B GM-BP	GM-10 GM-10P GM-B GM-BP		GM-10 GM-10P GM-B GM-BP
	MODELOS	80	GM-7 GM-7P GM-C GM-CP	GM-11 GM-11P GM-D GM-DP	GM-11 GM-11P GM-D GM-DP		GM-11 GM-11P GM-D GM-DP
	MODELOS	81	GM-8 GM-8P GM-E GM-EP	GM-12 GM-12P GM-H GM-HP	GM-12 GM-12P GM-H GM-HP		GM-12 GM-12P GM-H GM-HP
	MODELOS	82	GM-9 GM-9P GM-J GM-JP	GM-13 GM-13P GM-K GM-KP	GM-13 GM-13P GM-K GM-KP		GM-13 GM-13P GM-K GM-KP
	MODELOS	83	GM-6 GM-6P GM-A GM-AP	GM-10 GM-10P GM-B GM-BP	GM-10 GM-10P GM-B GM-BP		GM-10 GM-10P GM-B GM-BP
	MODELOS MODELOS	84 85	GM-6 GM-6P GM-7 GM-7P GM-A	GM-10 GM-10P GM-7 GM-7P GM-B	GM-10 GM-10P GM-B GM-BP		GM-10 GM-10P GM-B GM-BP



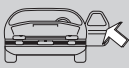



MARCA	MODELO						
			GM-AP GM-C GM-CP	GM-BP GM-C GM-CP			
GM (CHEVROLET BRA.)	COMMODEORE CHEVAIR CHEVROLET MONZA OMEGA	- - 82-87 82-87 -	OP-WHP OP-WYP	OP-WHP OP-WYP	OP-WHP OP-WYP	OP-WHP OP-WYP	OP-WHP OP-WYP
	CHEVETTE CHEVROLET	87-89 87-	OP-R OP-RP OP-T OP-TP	OP-R OP-RP OP-T OP-TP	OP-R OP-RP OP-T OP-TP	OP-R OP-RP OP-T OP-TP	OP-R OP-RP OP-T OP-TP
	CHEVROLET PANEMA	89-90 89-	OP-D OP-DKP OP-DP OP-S OP-SKP OP-SP	OP-D OP-DKP OP-DP OP-S OP-SKP OP-SP	OP-D OP-DKP OP-DP OP-S OP-SKP OP-SP	OP-D OP-DKP OP-DP OP-S OP-SKP OP-SP	OP-D OP-DKP OP-DP OP-S OP-SKP OP-SP
	CHEVROLET SPRINT 1.0	90- -	SUZU-7 SUZU-7P	SUZU-7 SUZU-7P	SUZU-7 SUZU-7P	SUZU-7 SUZU-7P	SUZU-7 SUZU-7P
	DIPLOMATA	-	CHR-8 CHR-8P	CHR-8 CHR-8P			
	MODELOS	35-66	BAS-1I	BAS-1I	BAS-1D		BAS-1D
	MODELOS MODELOS MODELOS MODELOS MODELOS	66 67 71 75 86	GM-6 GM-6P GM-A GM-AP	GM-6 GM-6P GM-A GM-AP	GM-10 GM-10P GM-B GM-BP		GM-10 GM-10P GM-B GM-BP
	MODELOS MODELOS	68 72	GM-7 GM-7P GM-C GM-CP	GM-7 GM-7P GM-C GM-CP	GM-11 GM-11P GM-D GM-DP		GM-11 GM-11P GM-D GM-DP
	MODELOS MODELOS	69 73	GM-8 GM-8P GM-E GM-EP	GM-8 GM-8P GM-E GM-EP	GM-12 GM-12P GM-H GM-HP		GM-12 GM-12P GM-H GM-HP
	MODELOS MODELOS MODELOS	70 74 78	GM-9 GM-9P GM-J GM-JP	GM-9 GM-9P GM-J GM-JP	GM-13 GM-13P GM-K GM-KP		GM-13 GM-13P GM-K GM-KP
	MODELOS	76	GM-7 GM-7P GM-C GM-CP	GM-11 GM-11P GM-7 GM-7P GM-C GM-CP GM-D	GM-11 GM-11P GM-D GM-DP		GM-11 GM-11P GM-D GM-DP

MARCA	MODELO						
				GM-DP			
	MODELOS	77	GM-8 GM-8P GM-E GM-EP	GM-12 GM-12P GM-8 GM-8P GM-E GM-EP GM-H GM-HP	GM-12 GM-12P GM-H GM-HP		GM-12 GM-12P GM-H GM-HP
	MODELOS	79	GM-6 GM-6P GM-A GM-AP	GM-10 GM-10P GM-6 GM-6P GM-A GM-AP GM-B GM-BP	GM-10 GM-10P GM-B GM-BP		GM-10 GM-10P GM-B GM-BP
	MODELOS	80	GM-7 GM-7P GM-C GM-CP	GM-11 GM-11P GM-D GM-DP	GM-11 GM-11P GM-D GM-DP		GM-11 GM-11P GM-D GM-DP
	MODELOS	81	GM-8 GM-8P GM-E GM-EP	GM-12 GM-12P GM-H GM-HP	GM-12 GM-12P GM-H GM-HP		GM-12 GM-12P GM-H GM-HP
	MODELOS	82	GM-9 GM-9P GM-J GM-JP	GM-13 GM-13P GM-K GM-KP	GM-13 GM-13P GM-K GM-KP		GM-13 GM-13P GM-K GM-KP
	MODELOS	83	GM-6 GM-6P GM-A GM-AP	GM-10 GM-10P GM-B GM-BP	GM-10 GM-10P GM-B GM-BP		GM-10 GM-10P GM-B GM-BP
	MODELOS	84	GM-6	GM-10	GM-10		GM-10
	MODELOS	85	GM-6P GM-7 GM-7P GM-A GM-AP GM-C GM-CP	GM-10P GM-7 GM-7P GM-B GM-BP GM-C GM-CP	GM-10P GM-B GM-BP		GM-10P GM-B GM-BP
GM (CHEVROLET)	ASTRO VAN	96-97	GM-14	GM-14	GM-14		GM-14
	CAVALIER	96-97	GM-14P	GM-14P	GM-14P		GM-14P
	LARGE BLAZER	96-97	GM-25	GM-25	GM-25		GM-25
	LARGE PICKUP	96-97	GM-25P	GM-25P	GM-25P		GM-25P
	MODELOS	95					
	S-10 BLAZER	96-97					
	S-10 PICKUP	96-97					
	VENTURE	97					



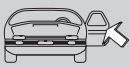



MARCA	MODELO						
	BERETTA CORSICA	87-90 87-90	GM-17P	GM-11 GM-11P GM-D GM-DP	GM-11 GM-11P GM-D GM-DP		GM-11 GM-11P GM-D GM-DP
	BERETTA CORSICA	91- 91-	GM-18P	GM-12 GM-12P GM-H GM-HP	GM-12 GM-12P GM-H GM-HP		GM-12 GM-12P GM-H GM-HP
	CAMARO CORVETTE	89-90 89-90		GM-11 GM-11P GM-D GM-DP	GM-11 GM-11P GM-D GM-DP		GM-11 GM-11P GM-D GM-DP
	CAMARO CAVALIER RS CORVETTE	91- 91- 91-		GM-12 GM-12P GM-H GM-HP	GM-12 GM-12P GM-H GM-HP		GM-12 GM-12P GM-H GM-HP
	CAVALIER LS	91-92	GM-22 GM-22P				
	CAVALIER LS	93-	GM-23 GM-23P				
	KODIAK 6 MODELOS WHEELER	97 81 97	GM-8 GM-8P GM-E GM-EP	GM-12 GM-12P GM-H GM-HP	GM-12 GM-12P GM-H GM-HP		GM-12 GM-12P GM-H GM-HP
	LUMINA	88-90	GM-19P	GM-11 GM-11P GM-D GM-DP	GM-11 GM-11P GM-D GM-DP		GM-11 GM-11P GM-D GM-DP
	LUMINA	91-	GM-20P	GM-12 GM-12P GM-H GM-HP	GM-12 GM-12P GM-H GM-HP		GM-12 GM-12P GM-H GM-HP
	MODELOS	35-66	BAS-1I	BAS-1I	BAS-1D		BAS-1D
	MODELOS MODELOS MODELOS MODELOS MODELOS	66 67 71 75 86	GM-6 GM-6P GM-A GM-AP	GM-6 GM-6P GM-A GM-AP	GM-10 GM-10P GM-B GM-BP		GM-10 GM-10P GM-B GM-BP
	MODELOS MODELOS	68 72	GM-7 GM-7P GM-C GM-CP	GM-7 GM-7P GM-C GM-CP	GM-11 GM-11P GM-D GM-DP		GM-11 GM-11P GM-D GM-DP
	MODELOS MODELOS	69 73	GM-8 GM-8P GM-E GM-EP	GM-8 GM-8P GM-E GM-EP	GM-12 GM-12P GM-H GM-HP		GM-12 GM-12P GM-H GM-HP

MARCA	MODELO						
	MODELOS MODELOS MODELOS	70 74 78	GM-9 GM-9P GM-J GM-JP	GM-9 GM-9P GM-J GM-JP	GM-13 GM-13P GM-K GM-KP		GM-13 GM-13P GM-K GM-KP
	MODELOS	76	GM-7 GM-7P GM-C GM-CP	GM-11 GM-11P GM-7 GM-7P GM-C GM-CP GM-D GM-DP	GM-11 GM-11P GM-D GM-DP		GM-11 GM-11P GM-D GM-DP
	MODELOS	77	GM-8 GM-8P GM-E GM-EP	GM-12 GM-12P GM-8 GM-8P GM-E GM-EP GM-H GM-HP	GM-12 GM-12P GM-H GM-HP		GM-12 GM-12P GM-H GM-HP
	MODELOS	79	GM-6 GM-6P GM-A GM-AP	GM-10 GM-10P GM-6 GM-6P GM-A GM-AP GM-B GM-BP	GM-10 GM-10P GM-B GM-BP		GM-10 GM-10P GM-B GM-BP
	MODELOS	80	GM-7 GM-7P GM-C GM-CP	GM-11 GM-11P GM-D GM-DP	GM-11 GM-11P GM-D GM-DP		GM-11 GM-11P GM-D GM-DP
	MODELOS	82	GM-9 GM-9P GM-J GM-JP	GM-13 GM-13P GM-K GM-KP	GM-13 GM-13P GM-K GM-KP		GM-13 GM-13P GM-K GM-KP
	MODELOS	83	GM-6 GM-6P GM-A GM-AP	GM-10 GM-10P GM-B GM-BP	GM-10 GM-10P GM-B GM-BP		GM-10 GM-10P GM-B GM-BP
	MODELOS MODELOS	84 85	GM-6 GM-6P GM-7 GM-7P GM-A GM-AP GM-C GM-CP	GM-10 GM-10P GM-7 GM-7P GM-B GM-BP GM-C GM-CP	GM-10 GM-10P GM-B GM-BP		GM-10 GM-10P GM-B GM-BP
	SPECTRUM	85-89	GM-2	GM-2	GM-2		



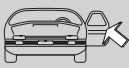



MARCA	MODELO						
			GM-2P	GM-2P	GM-2P		
	SPRINT	85-88	GM-1P MIT-2I	GM-1P MIT-2I	GM-1P MIT-2I		
GM (GEO)	METRO STROM	89- 90-	GM-5 GM-5P	GM-5 GM-5P	GM-5 GM-5P		GM-5 GM-5P
	PRIZM	93-94	GM-24 GM-24P	GM-24 GM-24P	GM-24 GM-24P		GM-24 GM-24P
	SPECTRUM STROM	85- 89-90	GM-2 GM-2P	GM-2 GM-2P	GM-2 GM-2P		GM-2 GM-2P
GM (GMC)	MODELOS	35-66	BAS-1I	BAS-1I	BAS-1D		BAS-1D
	MODELOS	66	GM-6	GM-6	GM-10		GM-10
	MODELOS	67	GM-6P	GM-6P	GM-10P		GM-10P
	MODELOS	71	GM-A	GM-A	GM-B		GM-B
	MODELOS	75	GM-AP	GM-AP	GM-BP		GM-BP
	MODELOS	86					
	MODELOS	68	GM-7	GM-7	GM-11		GM-11
	MODELOS	72	GM-7P GM-C GM-CP	GM-7P GM-C GM-CP	GM-11P GM-D GM-DP		GM-11P GM-D GM-DP
	MODELOS	69	GM-8	GM-8	GM-12		GM-12
MODELOS	73	GM-8P GM-E GM-EP	GM-8P GM-E GM-EP	GM-12P GM-H GM-HP		GM-12P GM-H GM-HP	
MODELOS	70	GM-9	GM-9	GM-13		GM-13	
MODELOS	74	GM-9P	GM-9P	GM-13P		GM-13P	
MODELOS	78	GM-J GM-JP	GM-J GM-JP	GM-K GM-KP		GM-K GM-KP	
MODELOS	76	GM-7 GM-7P GM-C GM-CP	GM-7 GM-7P GM-C GM-CP	GM-11 GM-11P GM-D GM-DP		GM-11 GM-11P GM-D GM-DP	
MODELOS	77	GM-8 GM-8P GM-E GM-EP	GM-8 GM-8P GM-E GM-EP	GM-12 GM-12P GM-H GM-HP		GM-12 GM-12P GM-H GM-HP	
MODELOS	79	GM-6 GM-6P GM-A	GM-6 GM-6P GM-A	GM-10 GM-10P GM-B		GM-10 GM-10P GM-B	

MARCA	MODELO						
			GM-AP	GM-6P GM-A GM-AP GM-B GM-BP	GM-BP		GM-BP
	MODELOS SIERRA GLE	80 91-	GM-7 GM-7P GM-C GM-CP	GM-11 GM-11P GM-D GM-DP	GM-11 GM-11P GM-D GM-DP		GM-11 GM-11P GM-D GM-DP
	MODELOS	81	GM-8 GM-8P GM-E GM-EP	GM-12 GM-12P GM-H GM-HP	GM-12 GM-12P GM-H GM-HP		GM-12 GM-12P GM-H GM-HP
	MODELOS	82	GM-9 GM-9P GM-J GM-JP	GM-13 GM-13P GM-K GM-KP	GM-13 GM-13P GM-K GM-KP		GM-13 GM-13P GM-K GM-KP
	MODELOS	83	GM-6 GM-6P GM-A GM-AP	GM-10 GM-10P GM-B GM-BP	GM-10 GM-10P GM-B GM-BP		GM-10 GM-10P GM-B GM-BP
	MODELOS MODELOS	84 85	GM-6 GM-6P GM-7 GM-7P GM-A GM-AP GM-C GM-CP	GM-10 GM-10P GM-7 GM-7P GM-B GM-BP GM-C GM-CP	GM-10 GM-10P GM-B GM-BP		GM-10 GM-10P GM-B GM-BP
GM (OLDS MOBILE)	98 REGENCY DELTA 88 RO. TORONADO	91- 92- 91-		GM-12 GM-12P GM-H GM-HP	GM-12 GM-12P GM-H GM-HP		GM-12 GM-12P GM-H GM-HP
	ACHIEVA	92-93	GM-22 GM-22P GM-23 GM-23P				
	ACHIEVA AURORA	94 95	GM-14 GM-14P GM-25 GM-25P	GM-14 GM-14P GM-25 GM-25P	GM-14 GM-14P GM-25 GM-25P		GM-14 GM-14P GM-25 GM-25P
	CUTLASS SILHOUETTE	88-90 88-90	GM-19P				
	CUTLASS SUP.	91-	GM-20P				
	MODELOS	35-66	BAS-1I	BAS-1I	BAS-1D		BAS-1D
	MODELOS	66	GM-6	GM-6	GM-10		GM-10



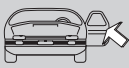



MARCA	MODELO						
	MODELOS MODELOS MODELOS MODELOS	67 71 75 86	GM-6P GM-A GM-AP	GM-6P GM-A GM-AP	GM-10P GM-B GM-BP		GM-10P GM-B GM-BP
	MODELOS MODELOS	68 72	GM-7 GM-7P GM-C GM-CP	GM-7 GM-7P GM-C GM-CP	GM-11 GM-11P GM-D GM-DP		GM-11 GM-11P GM-D GM-DP
	MODELOS MODELOS	69 73	GM-8 GM-8P GM-E GM-EP	GM-8 GM-8P GM-E GM-EP	GM-12 GM-12P GM-H GM-HP		GM-12 GM-12P GM-H GM-HP
	MODELOS MODELOS MODELOS	70 74 78	GM-9 GM-9P GM-J GM-JP	GM-9 GM-9P GM-J GM-JP	GM-13 GM-13P GM-K GM-KP		GM-13 GM-13P GM-K GM-KP
	MODELOS	76	GM-7 GM-7P GM-C GM-CP	GM-11 GM-11P GM-7 GM-7P GM-C GM-CP GM-D GM-DP	GM-11 GM-11P GM-D GM-DP		GM-11 GM-11P GM-D GM-DP
	MODELOS	77	GM-8 GM-8P GM-E GM-EP	GM-12 GM-12P GM-8 GM-8P GM-E GM-EP GM-H GM-HP	GM-12 GM-12P GM-H GM-HP		GM-12 GM-12P GM-H GM-HP
	MODELOS	79	GM-6 GM-6P GM-A GM-AP	GM-10 GM-10P GM-6 GM-6P GM-A GM-AP GM-B GM-BP	GM-10 GM-10P GM-B GM-BP		GM-10 GM-10P GM-B GM-BP
	MODELOS	80	GM-7 GM-7P GM-C GM-CP	GM-11 GM-11P GM-D GM-DP	GM-11 GM-11P GM-D GM-DP		GM-11 GM-11P GM-D GM-DP
	MODELOS	81	GM-8 GM-8P GM-E GM-EP	GM-12 GM-12P GM-H GM-HP	GM-12 GM-12P GM-H GM-HP		GM-12 GM-12P GM-H GM-HP
	MODELOS	82	GM-9	GM-13	GM-13		GM-13

MARCA	MODELO						
			GM-9P GM-J GM-JP	GM-13P GM-K GM-KP	GM-13P GM-K GM-KP		GM-13P GM-K GM-KP
	MODELOS	83	GM-6 GM-6P GM-A GM-AP	GM-10 GM-10P GM-B GM-BP	GM-10 GM-10P GM-B GM-BP		GM-10 GM-10P GM-B GM-BP
	MODELOS MODELOS	84 85	GM-6 GM-6P GM-7 GM-7P GM-A GM-AP GM-C GM-CP	GM-10 GM-10P GM-7 GM-7P GM-B GM-BP GM-C GM-CP	GM-10 GM-10P GM-B GM-BP		GM-10 GM-10P GM-B GM-BP
	TORONADO	89-90		GM-11 GM-11P GM-D GM-DP	GM-11 GM-11P GM-D GM-DP		GM-11 GM-11P GM-D GM-DP
GM (PONTIAC)	BONNEVILLE FIREBIRD FORMULA GTA TRANS AM	92- 91- 91- 91- 91-		GM-12 GM-12P GM-H GM-HP	GM-12 GM-12P GM-H GM-HP		GM-12 GM-12P GM-H GM-HP
	GRAND AM SUNBIRD	92-93 92-93	GM-22 GM-22P GM-23 GM-23P				
	GRAND AM	94	GM-14 GM-14P GM-25 GM-25P	GM-14 GM-14P GM-25 GM-25P	GM-14 GM-14P GM-25 GM-25P	GM-14 GM-14P GM-25 GM-25P	GM-14 GM-14P GM-25 GM-25P
	GRAND PRIX	91-94	GM-20P				
	LE MANS	87-	OP-S OP-SKP OP-SP	OP-S OP-SKP OP-SP	OP-S OP-SKP OP-SP	OP-S OP-SKP OP-SP	OP-S OP-SKP OP-SP
	MODELOS	35-66	BAS-1I	BAS-1I	BAS-1D		BAS-1D
	MODELOS MODELOS MODELOS MODELOS MODELOS	66 67 71 75 86	GM-6 GM-6P GM-A GM-AP	GM-6 GM-6P GM-A GM-AP	GM-10 GM-10P GM-B GM-BP		GM-10 GM-10P GM-B GM-BP
	MODELOS MODELOS	68 72	GM-7 GM-7P GM-C GM-CP	GM-7 GM-7P GM-C GM-CP	GM-11 GM-11P GM-D GM-DP		GM-11 GM-11P GM-D GM-DP



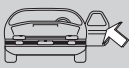



MARCA	MODELO						
	MODELOS MODELOS	69 73	GM-8 GM-8P GM-E GM-EP	GM-8 GM-8P GM-E GM-EP	GM-12 GM-12P GM-H GM-HP		GM-12 GM-12P GM-H GM-HP
	MODELOS MODELOS MODELOS	70 74 78	GM-9 GM-9P GM-J GM-JP	GM-9 GM-9P GM-J GM-JP	GM-13 GM-13P GM-K GM-KP		GM-13 GM-13P GM-K GM-KP
	MODELOS	76	GM-7 GM-7P GM-C GM-CP	GM-11 GM-11P GM-7 GM-7P GM-C GM-CP GM-D GM-DP	GM-11 GM-11P GM-D GM-DP		GM-11 GM-11P GM-D GM-DP
	MODELOS	77	GM-8 GM-8P GM-E GM-EP	GM-12 GM-12P GM-8 GM-8P GM-E GM-EP GM-H GM-HP	GM-12 GM-12P GM-H GM-HP		GM-12 GM-12P GM-H GM-HP
	MODELOS	79	GM-6 GM-6P GM-A GM-AP	GM-10 GM-10P GM-6 GM-6P GM-A GM-AP GM-B GM-BP	GM-10 GM-10P GM-B GM-BP		GM-10 GM-10P GM-B GM-BP
	MODELOS	80	GM-7 GM-7P GM-C GM-CP	GM-11 GM-11P GM-D GM-DP	GM-11 GM-11P GM-D GM-DP		GM-11 GM-11P GM-D GM-DP
	MODELOS	81	GM-8 GM-8P GM-E GM-EP	GM-12 GM-12P GM-H GM-HP	GM-12 GM-12P GM-H GM-HP		GM-12 GM-12P GM-H GM-HP
	MODELOS	82	GM-9 GM-9P GM-J GM-JP	GM-13 GM-13P GM-K GM-KP	GM-13 GM-13P GM-K GM-KP		GM-13 GM-13P GM-K GM-KP
	MODELOS	83	GM-6 GM-6P GM-A GM-AP	GM-10 GM-10P GM-B GM-BP	GM-10 GM-10P GM-B GM-BP		GM-10 GM-10P GM-B GM-BP
	MODELOS	84	GM-6	GM-10	GM-10		GM-10

MARCA	MODELO						
	MODELOS	85	GM-6P GM-7 GM-7P GM-A GM-AP GM-C GM-CP	GM-10P GM-7 GM-7P GM-B GM-BP GM-C GM-CP	GM-10P GM-B GM-BP		GM-10P GM-B GM-BP
	TRANS SPORT	88-90	GM-19P				
GM (SATURN)	SATURN	90-94	GM-21 GM-21P	GM-21 GM-21P	GM-21 GM-21P		GM-21 GM-21P
HAMOMAG HENSCHEL	F 20 F 35	- -	ME-VA	ME-VA	ME-VA		
HOLDEN	APOLLO NOVA	91- 91-	TOYO-14 TOYO-14P	TOYO-14 TOYO-14P	TOYO-14 TOYO-14P		
	ASTRA	86	DAT-12	DAT-12	DAT-12		
	BARINA CAMIRA DROVER GEMINI JACKAROO RODEO SHUTTLE	81-90 80- 81- 80-84 80- 80- 80-	MIT-1I MIT-1IP TOYO-14 TOYO-14P	MIT-1I MIT-1IP TOYO-14 TOYO-14P	MIT-1I MIT-1IP TOYO-14 TOYO-14P		
	BARINA	91-93	SUZU-10 SUZU-10P	SUZU-10 SUZU-10P	SUZU-10 SUZU-10P	SUZU-10 SUZU-10P	SUZU-10 SUZU-10P
	BARINA	94	OP-S OP-SKP OP-SP	OP-S OP-SKP OP-SP	OP-S OP-SKP OP-SP	OP-S OP-SKP OP-SP	OP-S OP-SKP OP-SP
	BELMOND KINGSWOOD STATESMAN TORANA	71-78 71-78 72-78 71-72	GM-6 GM-6P GM-A GM-AP	GM-6 GM-6P GM-A GM-AP	GM-10 GM-10P GM-B GM-BP		
	CALAIS COMMODORE	93- 93-	OP-WHP	OP-WHP	OP-WHP		
	COMMODORE	87-93	OP-WHP OP-WYP	OP-WHP OP-WYP	OP-WHP OP-WYP		
	FJ	-	HUD-1	HUD-1			
	GEMINI SPECTRUM	85- 85-	GM-2 GM-2P	GM-2 GM-2P	GM-2 GM-2P		
	GEMINI STAT.	81-	MIT-1I MIT-1IP TOYO-14 TOYO-14P	OP-AB OP-ABP OP-BA OP-BAP OP-J OP-JP	OP-AB OP-ABP OP-BA OP-BAP OP-J OP-JP		



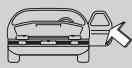



MARCA	MODELO						
	MODELOS	55-70	BAS-1I	BAS-1I	BAS-1I		
	TORANA	-71	BAS-1I	UN-FS	UN-FS		
HONDA	ACCORD	76-80	HOND-1 HOND-1P HOND-2 HOND-2P	HOND-1 HOND-1P HOND-2 HOND-2P	HOND-1 HOND-1P HOND-2 HOND-2P	HOND-1 HOND-1P HOND-2 HOND-2P	HOND-1 HOND-1P HOND-2 HOND-2P
	ACCORD ACCORD PRELUDE QUINTET	81-82 84-90 83-88 81-83	HOND-10 HOND-10P	HOND-10 HOND-10P	HOND-10 HOND-10P	HOND-10 HOND-10P	HOND-10 HOND-10P
	ACCORD	82-83	HOND-10 HOND-10P HOND-11 HOND-11P	HOND-10 HOND-10P HOND-11 HOND-11P	HOND-10 HOND-10P HOND-11 HOND-11P	HOND-10 HOND-10P HOND-11 HOND-11P	HOND-10 HOND-10P HOND-11 HOND-11P
	ACCORD	90-92	HOND-14 HOND-14P HOND-15 HOND-15P HOND-16D HOND-16DP	HOND-14 HOND-14P HOND-15 HOND-15P HOND-16D HOND-16DP	HOND-14 HOND-14P HOND-16D HOND-16DP	HOND-14 HOND-14P HOND-15 HOND-15P HOND-16D HOND-16DP	HOND-14 HOND-14P HOND-16D HOND-16DP
	ACCORD 2 LS ACCORD 2 S CIVIC CONCERTO	93-95 93-95 95 89-	NE-35 NE-35P2	NE-35 NE-35P2	NE-35 NE-35P2	NE-35 NE-35P2	NE-35 NE-35P2
	ACCORD COUPE CIVIC	93-95 88-95	HOND-14 HOND-14P	HOND-14 HOND-14P	HOND-14 HOND-14P	HOND-14 HOND-14P	HOND-14 HOND-14P
	ACCORD EX	91-95	HOND-16D HOND-16DP	HOND-16D HOND-16DP	HOND-16D HOND-16DP	HOND-16D HOND-16DP	HOND-16D HOND-16DP
	CITY JAZZ	81-85	HOND-10 HOND-10P	HOND-10 HOND-10P	HOND-10 HOND-10P		HOND-10 HOND-10P
	CIVIC	72-73	NE-1 NE-1P	HOND-3D	HOND-3D		HOND-14 HOND-14P
	CIVIC	73-76	HOND-1 HOND-1P HOND-2 HOND-2P	HOND-1 HOND-1P HOND-2 HOND-2P	HOND-1 HOND-1P HOND-2 HOND-2P	HOND-1 HOND-1P HOND-2 HOND-2P	
	CIVIC	77-81	HOND-10 HOND-10P HOND-11 HOND-11P	HOND-10 HOND-10P HOND-11 HOND-11P	HOND-10 HOND-10P HOND-11 HOND-11P	HOND-10 HOND-10P HOND-11 HOND-11P	
	CIVIC	82-83	HOND-12 HOND-12P HOND-13 HOND-13P	HOND-12 HOND-12P HOND-13 HOND-13P	HOND-12 HOND-12P HOND-13 HOND-13P	HOND-12 HOND-12P HOND-13 HOND-13P	

MARCA	MODELO						
	CIVIC PRELUDE	84-87 89-91	HOND-10 HOND-10P	HOND-10 HOND-10P	HOND-10 HOND-10P	HOND-10 HOND-10P	
	CIVIC CRX CIVIC SHUTTLE	89-92 89-92	HOND-14 HOND-14P HOND-15 HOND-15P	HOND-14 HOND-14P HOND-15 HOND-15P	HOND-14 HOND-14P HOND-15 HOND-15P	HOND-14 HOND-14P HOND-15 HOND-15P	HOND-14 HOND-14P HOND-15 HOND-15P
	COUPE LIFE N 360 TOURER	69-75 69-75 69-75 69-75	NE-1 NE-1P			HOND-14 HOND-14P	
	PRELUDE	82	HOND-12 HOND-12P HOND-13 HOND-13P	HOND-12 HOND-12P HOND-13 HOND-13P	HOND-12 HOND-12P HOND-13 HOND-13P	HOND-12 HOND-12P HOND-13 HOND-13P	HOND-12 HOND-12P HOND-13 HOND-13P
	PRELUDE	92-97	HOND-14 HOND-14P HOND-16D HOND-16DP	HOND-14 HOND-14P HOND-16D HOND-16DP	HOND-14 HOND-14P HOND-16D HOND-16DP	HOND-14 HOND-14P HOND-16D HOND-16DP	HOND-14 HOND-14P HOND-16D HOND-16DP
HYUNDAI	ACCENT EXCEL	94-96 94-95	HY-5 HY-5P	HY-5 HY-5P	HY-5 HY-5P		HY-5 HY-5P
	ELANTRA LANTRA	91-96 91-96	HY-4 HY-4P HY-4P2	HY-4 HY-4P HY-4P2	HY-4 HY-4P HY-4P2	HY-4 HY-4P HY-4P2	
	EXCEL	86-89	HY-3D HY-3DP	HY-3D HY-3DP	HY-3D HY-3DP		
	EXCEL	90-91	HY-3D HY-3DP1	HY-3D HY-3DP1	HY-3D HY-3DP1	KAW-4	
	PONY	74-79	HY-1	HY-1	HY-1		
	PONY	80-84	TOYO-14 TOYO-14P	TOYO-14 TOYO-14P	TOYO-14 TOYO-14P	KAW-4	
	PONY S COUPE SONATA	91- 91-96 91-96	HY-3D HY-3DP1	HY-3D HY-3DP1	HY-3D HY-3DP1	HY-3D HY-3DP1	
	PONY (CAN)	85-87	MIT-2I MIT-2IP	MIT-2I MIT-2IP	MIT-2I MIT-2IP		
	PONY (EU) STELLAR	85-87 85-87	HY-2 HY-2P HY-7P	HY-2 HY-2P HY-7P	HY-2 HY-2P HY-7P		
	SONATA	89-90	HY-3 HY-3P2	HY-3 HY-3P2	HY-3 HY-3P2	HY-3 HY-3P2	
	SONATA (USA) SONICA	93-95 93-95	HY-6D HY-6DP	HY-6D HY-6DP	HY-6D HY-6DP		HY-6D HY-6DP



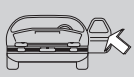



MARCA	MODELO							
	STAREX	1998	HY-9P2	HY-9P2	HY-9P2		HY-9P2	
	VAN TRANSP.	94-97	HY-8 HY-8P	HY-8 HY-8P	HY-8 HY-8P			
INFINITI (NISSAN)	G 20 M 30	92- 92-	DAT-10 DAT-10P DAT-7 DAT-7P DAT-7P1	DAT-10 DAT-10P DAT-7 DAT-7P DAT-7P1	DAT-10 DAT-10P DAT-7 DAT-7P DAT-7P1	DAT-10 DAT-10P DAT-7 DAT-7P DAT-7P1	DAT-10 DAT-10P DAT-7 DAT-7P DAT-7P1	
	M 30	90-91	DAT-13 DAT-13P DAT-14 DAT-14P	DAT-13 DAT-13P DAT-14 DAT-14P	DAT-14 DAT-14P		DAT-14 DAT-14P	
INNOCENTI	3 CILINDROS MINI 650 MINI DIESEL MINI MILLE MINI TRE MINI TURBO	82 85 84 80 84 83		AF-10 AF-11 AF-12			FAR-1D FAR-1I	
	500 650 990 SMALL 500 SMALL 990	86- 86- 86- 86- 86-	FI-6I FI-6IP	FI-6I FI-6IP	FI-6I FI-6IP	FAR-1D FAR-1I		
	A40	-	UN-FP	UN-FP	UN-FP			
	ELBA	92-	FI-11 FI-11KP FI-11P	FI-11 FI-11KP FI-11P	FI-11 FI-11KP FI-11P	FI-11 FI-11KP FI-11P	FI-11 FI-11KP FI-11P	
	J 4 J 5 JM 3 MINI 850 MINI 1000 MINI 1001 MINI COOPER	- - - - 73 73 73	LF-BL UN-FS	UN-FS	UN-FS			
	KORAL 45 KORAL 55	90-92 90-92	FI-6I FI-6IP	FI-3D FI-3DP FI-3DP5	FI-3D FI-3DP FI-3DP5	FI-3D FI-3DP FI-3DP5		
	MINI 90 MINI 120 M.DE TOMASO	74 74 76	AF-7I AF-7IP	AF-10 AF-11 AF-12		AF-5D FAR-1D FAR-1I		
	MINI MATIC	70-	LF-BL UN-FS	AF-10 AF-11 AF-12 UN-FS	UN-FS		FAR-1D FAR-1I	
	M.COOPER OR.	-	STR-2	STR-2	STR-2			

MARCA	MODELO						
	M.MK II 850	-	UN-FS	UN-FS	UN-FS		
	M.METALLICA M.T.CLUBMAN	- -	LF-RO LF-ROP	UN-FS	UN-FS	PJ-K PJ-KP	
	REGENT	-	LF-BL	UN-FT	UN-FT		
INTER. HARVESTER	T.TERRENO	-	GM-6 GM-6P GM-A GM-AP	GM-10 GM-10P GM-B GM-BP			
	VARIOS	40-75	KEN-1	KEN-1	HUD-1		HUD-1
IRMSCHER	4.0 I	-81	GM-9 GM-9P GM-J GM-JP	OP-R OP-RP OP-T OP-TP	OP-R OP-RP OP-T OP-TP	OP-R OP-RP OP-T OP-TP	OP-R OP-RP OP-T OP-TP
	4.0 I	81-86	OP-R OP-RP OP-T OP-TP	OP-R OP-RP OP-T OP-TP	OP-R OP-RP OP-T OP-TP	OP-R OP-RP OP-T OP-TP	
	4.0 I C.40 E	86- -	OP-WHP OP-WYP	OP-WHP OP-WYP	OP-WHP OP-WYP	OP-WHP OP-WYP	OP-WHP OP-WYP
ISUZU	AMIGO TF	88-91 88-91	GM-4 GM-4P GM-4P1	GM-4 GM-4P GM-4P1	GM-4 GM-4P GM-4P1		GM-4 GM-4P GM-4P1
	AMIGO RODEO	91-94 91-94	GM-15D GM-15DP	GM-15D GM-15DP	GM-15D GM-15DP		GM-15D GM-15DP
	I MARK	85-91	GM-2 GM-2P	GM-2 GM-2P	GM-2 GM-2P		GM-2 GM-2P
	IMPULSE PIAZZA TROOPER	85-91 85-91 85-91	MIT-2I MIT-2IP	MIT-2I MIT-2IP	MIT-2I MIT-2IP		MIT-2I MIT-2IP
	IMPULSE STYLUS	92- 92-	GM-5 GM-5P	GM-5 GM-5P	GM-5 GM-5P		GM-5 GM-5P
	MODELOS	81-84	MIT-1I MIT-1IP	MIT-1I MIT-1IP	MIT-1I MIT-1IP		MIT-1I MIT-1IP
	TROOPER	82-84	TOYO-14 TOYO-14P	TOYO-14 TOYO-14P	TOYO-14 TOYO-14P		TOYO-14 TOYO-14P
	TROOPER	91-	GM-1P	GM-1P	GM-1P		GM-1P
JAGUAR	E	70-74	FO-D FO-FR FO-FRP WAS-2P	UN-1FS UN-FS	UN-1FS UN-FS		
	MAJESTIC	89-94	JAU-1P	JAU-1P	JAU-1P	JAU-1P	JAU-1P



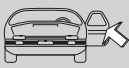



MARCA	MODELO						
	SOVEREIGN VANDEN PLAS XJ 6	89-94 89-94 89-94					
	VANDEN PLAS XJ 6-40	88-89 88-89			FO-E/TC FO-E/TCP		FO-E/TC FO-E/TCP
	XJ 6	71-75	FO-D FO-FR FO-FRP WAS-2P	IN-4 UN-1FS UN-FS UN-FT	IN-4 UN-1FS UN-FS UN-FT	WAS-1	
	XJ 6	76-78	FO-FR FO-FRP WAS-2P	FO-5	FO-5	WAS-1	
	XJ 6-12	79-87	FO-FR FO-FRP WAS-2P	CEM-JC	CEM-JC	WAS-1	
	XJS	75	FO-FR FO-FRP WAS-2P	UN-FT	UN-FT		
	XJS	76	FO-FR FO-FRP WAS-2P	LF-WR	FO-TC		
	XJS	76-77	LF-WR	FO-TC			
	XJS	78-87	FO-FR FO-FRP WAS-2P	LF-WR	CEM-JC FO-E/TC FO-E/TCP	FO-5	CEM-JC FO-E/TC FO-E/TCP
	XJS	88-	JAU-1P	JAU-1P	FO-E/TC FO-E/TCP		FO-E/TC FO-E/TCP
JEEP	BRIAR WOOD COMANCHE CHEROKEE LAREDO LTD WRANGLER	91-92 91-92 91-92 91-92 91-92 91-92	CHR-9 CHR-9P	CHR-9 CHR-9P	CHR-9 CHR-9P		CHR-9 CHR-9P
	COMANCHE SCRAMBLER WAGONEERS WRANGLER	85-90 85-90 85-90 85-90	GM-9 GM-9P GM-J GM-JP				
	COMANCHE COUNTRY CHEROKEE G.CHEROKEE G.WAGONEER LAREDO LTD RENEGADE SAHARA	93- 93- 93-98 93-98 93- 93- 93- 93- 93-	CHR-10 CHR-10P	CHR-10 CHR-10P	CHR-10 CHR-10P		CHR-10 CHR-10P

MARCA	MODELO						
	SPURR WAGONEER WRANGLER	93- 93- 93-					
	COMMANDO D	-	FEM-3I	CL-4I	CL-4I		
	PIONNER	-91	GM-9 GM-9P GM-J GM-JP			BS-4D YA-8D	
	RENEGADE	79-84	GM-9 GM-9P GM-J GM-JP	YA-11D	YA-11D		
	VARIOS	40-73	KEN-1	KEN-1	HUD-1		HUD-1
JENSEN	INTERCEPT. 2 INTERCEPT. 3	- -	FO-FR FO-FRP	UN-FS	UN-FS		
KENWORTH	VARIOS	50-87	KEN-1	KEN-1	KEN-1		KEN-1
	VARIOS	60-86	HUD-1	HUD-1	HUD-1		HUD-1
KIA	CARNIVAL SHUMA	99- 98-	KI-3DP	KI-3DP	KI-3DP	KI-3DP	KI-3DP
	PRIDE 1.1 L PRIDE 1.3 LX SEPHIA 1.6 I SEPHIA (USA) SPORTAGE	92-94 92-94 93-94 94-95 95-96	KI-1D KI-1DP	KI-1D KI-1DP	KI-1D KI-1DP	KI-1D KI-1DP	KI-1D KI-1DP
	SEPHIA (USA)	94-	KI-1DP1	KI-1DP1	KI-1DP1	KI-1DP1	KI-1DP1
	SPORTAGE USA	96-	KI-2D	KI-2D	KI-2D	KI-2D	KI-2D
LA FORZA	FORZA 5.0 V8	89-		GIOB-3P	GIOB-3P		
LADA VAZ	1200 1300 1500 1600 2101 2102 2103 2104 2105 2106 2107 21011 21043 21061 NIVA RIVA	72- 72- 72- 72- 72- 72- 72- 72- 72- 72- 72- 72- 72- 72- - -	NE-3 NE-3P NE-3P1 NE-3P2	IMS-3 IMS-3P IMS-5 IMS-5P	IMS-3 IMS-3P IMS-5 IMS-5P		
	3110	-	LA-3D	LA-2	LA-2		



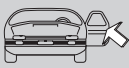



MARCA	MODELO						
			LA-3DP LA-4D LA-4DP	LA-2P	LA-2P		
	4x4 4x4 G.LARGE KAMA SAGONA	- - 84- -	LA-1D LA-1DP LA-2 LA-2P LA-3D LA-3DP	LA-1D LA-1DP LA-2 LA-2P LA-3D LA-3DP	LA-1D LA-1DP LA-2 LA-2P LA-3D LA-3DP		
	CARLOTA SAMARA	91- 91-92	LA-1D LA-1DP	LA-1D LA-1DP	LA-1D LA-1DP		
	NIVA 1.6	92-	NE-3 NE-3P NE-3P1 NE-3P2	IMS-3 IMS-3P	IMS-3 IMS-3P		
	SAMARA	92-	LA-3D LA-3DP	LA-2 LA-2P	LA-2 LA-2P		
LAMBORGHINI	COUNTACH JALPA URRACO	- - -	AF-7I AF-7IP AF-7IP1	IMS-3 IMS-3P IMS-5 IMS-5P	IMS-3 IMS-3P IMS-5 IMS-5P		
	DIABLO COU. DIABLO ROA.	- -	AF-7I AF-7IP AF-7IP1	IMS-3 IMS-3P IMS-5 IMS-5P	IMS-3 IMS-3P IMS-5 IMS-5P		AF-5D AF-5I AF-6D AF-6I
	ESPADA	-	AF-7I AF-7IP AF-7IP1	AF-5I AF-6I	AF-5I AF-6I	AF-6D	
	MIURA	-	BH-1 BH-1P	AF-4D AF-4I AF-5D AF-5I AF-6D AF-6I	AF-4D AF-4I AF-5D AF-5I AF-6D AF-6I		
LANCIA	2000 APPIA FLAVIA FULVIA	-72 -72 -72 -72	GIOB-1D GIOB-1DP	GIOB-2I GIOB-2IP	GIOB-2I GIOB-2IP		
	2000 FULVIA	72- 72-	GIOB-1D GIOB-1DP SIP-3	GIOB-2I GIOB-2IP			
	BETA DELTA GAMMA	72-82 79-82 72-82	AF-7I AF-7IP FI-9I FI-9IP	GIOB-3P	GIOB-3P	GIOB-3P	GIOB-3P
	BETA	75-80	AF-7I	AF-10	AF-10		

MARCA	MODELO						
	MONTECARLO	75-80	AF-7IP	AF-11 AF-12	AF-11 AF-12		
	DEDRA DEDRA S.W. DELTA	89-95 94 93-95	FI-13 FI-13P FI-14P	FI-13 FI-13P FI-14P	FI-13 FI-13P		FI-13 FI-13P
	DELTA	83	FI-3D FI-3DP FI-3DP3 FI-6I FI-6IP FI-6IP3	GIOB-3P	GIOB-3P	GIOB-3P	GIOB-3P
	DELTA PRISMA	84-92 84-89	FI-11 FI-11KP FI-11P	GIOB-3P	GIOB-3P	GIOB-3P	GIOB-3P
	LANCIA Z Z 2000	94 94	SIX-3P1	SIX-3P1	SIX-3P1		SIX-3P1
	THEMA	84-	FI-10 FI-10P FI-11 FI-11KP FI-11P	FI-10 FI-10P FI-11 FI-11KP FI-11P	FI-11 FI-11KP FI-11P		FI-11 FI-11KP FI-11P
	TREVI	80-	FI-9I FI-9IP	GIOB-3P	GIOB-3P	GIOB-3P	GIOB-3P
LAND-RANGE ROVER	88 109	82-83 82-83	LF-RO LF-ROP	UN-FS	UN-FS	UN-FS	UN-FS
	88 109 110	84 84 84	LF-RO LF-ROP	UN-FS	UN-FS	UN-FT	UN-FS
	88 109 110 SANTANA	85-87 85-87 85-87 85-87	LF-RO LF-ROP	AB-6I	UN-FT		UN-FT
	90 110	85-86 85-86	LF-RO LF-ROP	LF-RO LF-ROP	IN-1		
	90 110 DEFENDER	87-91 87-91 90-	LF-RO LF-ROP	UN-FT	UN-FT	UN-FT	UN-FT
	90 2500 90 3500 110 2500 110 3500 SANTANA	88-91 88-91 85-87 85-87 87-91	IMS-7 IMS-7P	AB-6I	AB-6I	AB-6I	AB-6I
	DISCOVERY	89-93	NE-11 NE-11P1 NE-11P2	NE-11 NE-11P1 NE-11P2	NE-11 NE-11P1 NE-11P2	NE-11 NE-11P1 NE-11P2	NE-11 NE-11P1 NE-11P2



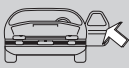



MARCA	MODELO						
	DISCOVERY	94-97	NE-52P	NE-52P	NE-52P	NE-52P	NE-52P
	MODELOS	70-72	UN-FS	UN-FP	UN-FP		
	MODELOS	73-81	UN-FS	UN-FS	UN-FS		
	R.ROVER	-83	UN-NH UN-NHP	UN-NH UN-NHP	UN-FS		
	R.ROVER	84-88	NE-11 NE-11P NE-11P1 NE-11P2 NE-24 NE-24P NE-24P1	NE-11 NE-11P NE-11P1 NE-11P2 NE-24 NE-24P NE-24P1	UN-FS	UN-FT	UN-FT
	R.ROVER	89-97	NE-11 NE-11P	NE-11 NE-11P	NE-11 NE-11P	NE-11 NE-11P	NE-11 NE-11P
LEXUS (TOYOTA)	250 ES 300 ES 400 LS COUPE 300 SC COUPE 400 SC	89- 89- 89- 91- 91-	TOYO-18P	TOYO-18P	TOYO-18P		TOYO-18P
LOTUS	ECLAT EXCEL SE	- -	TOYO-K1 TOYO-K1P	TOYO-K1 TOYO-K1P	TOYO-K1 TOYO-K1P		
	ELAN SE	91	OP-D OP-DKP OP-DP	OP-D OP-DKP OP-DP	OP-D OP-DKP OP-DP	GM-12 GM-12P GM-H GM-HP	
	ESPRIT 2.2 ESPRIT TURBO	- -	LF-RO LF-ROP	UN-FT		WAS-6 WAS-6P	
	ESPRIT COUPE	91-	LF-RO LF-ROP	UN-FT	UN-FT		
	MODELOS	-76	FO-FR FO-FRP LF-RO LF-ROP	UN-FS UN-FT	UN-FS UN-FT		
MACK	VARIOS	55-69	KEN-1	KEN-1	KEN-1		KEN-1
	VARIOS	70-86	HUD-1	HUD-1	HUD-1		HUD-1
MARUTI	800 800 LUXE 800 S.LUXE	91-92 91-92 91-92	SUZU-7 SUZU-7P	SUZU-7 SUZU-7P	SUZU-7 SUZU-7P	SUZU-7 SUZU-7P	
MASERATI	BITURBO GHIBLI KARIF SHAMAL	81- 86- 86- 86-	LF-RO LF-ROP	AF-10 AF-11 AF-12	AF-10 AF-11 AF-12	AF-5D AF-6D	AF-10 AF-11 AF-12

MARCA	MODELO						
	SPYDER	86-					
	BORA	71-76	AF-7I AF-7IP AF-7IP1	RO-5D	RO-5D	GIOB-2I GIOB-2IP	
	GHIBLI 5000	-		IMS-3 IMS-3P	IMS-3 IMS-3P		
	INDY 4900 A.	69-	AF-7I AF-7IP AF-7IP1	GIOB-2I GIOB-2IP RO-5D	GIOB-2I GIOB-2IP RO-5D	GIOB-2I GIOB-2IP	
	KHAMSIN	72-	AF-7I AF-7IP AF-7IP1	IMS-3 IMS-3P IMS-5 IMS-5P	IMS-3 IMS-3P IMS-5 IMS-5P		
	KYALAMI	76-	FO-2	IMS-5 IMS-5P	IMS-5 IMS-5P		
	MERAK	72-76	CT-3 CT-3P	RO-5D	RO-5D		
	QUATTROPORTE	76-86	LF-RO LF-ROP	AF-10 AF-11 AF-12	AF-10 AF-11 AF-12	AF-5D	AF-10 AF-11 AF-12
MAZDA	121 323 323 S.W. 626 626 S.W. 727 929 S.W. COSMO MX6 RX7	88-90 83-89 86-96 87-91 86-92 87-91 82- 84-86 86-89 87-91	MAZ-3D MAZ-6DP	MAZ-3D MAZ-6DP	MAZ-3D MAZ-6DP	MAZ-3D MAZ-6DP	MAZ-3D MAZ-6DP
	121	91-92	MAZ-5D MAZ-5DP MAZ-7D MAZ-7DP	MAZ-5D MAZ-5DP MAZ-7D MAZ-7DP	MAZ-5D MAZ-5DP MAZ-7D MAZ-7DP	MAZ-5D MAZ-5DP MAZ-7D MAZ-7DP	MAZ-5D MAZ-5DP MAZ-7D MAZ-7DP
	121 323 MX3 MX5 RX7 XEDOS	93-94 92-94 92-95 92-95 92- 92-96	MAZ-13D MAZ-13DP MAZ-13DP1 MAZ-7D MAZ-7DP	MAZ-13D MAZ-13DP MAZ-13DP1 MAZ-7D MAZ-7DP	MAZ-13D MAZ-13DP MAZ-13DP1 MAZ-7D MAZ-7DP	MAZ-13D MAZ-13DP MAZ-13DP1 MAZ-7D MAZ-7DP	MAZ-13D MAZ-13DP MAZ-13DP1 MAZ-7D MAZ-7DP
	121	95-	FO-6P	FO-6P	FO-6P	FO-6P	FO-6P
	323 323 S.W. 626 929 929 S.W.	77-82 77-86 78-82 80-82 80-82	MAZ-2D MAZ-2DP	MAZ-2D MAZ-2DP	MAZ-2D MAZ-2DP	MAZ-2D MAZ-2DP	MAZ-2D MAZ-2DP



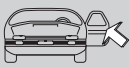



MARCA	MODELO						
	323	82-83	MAZ-3D MAZ-3DP MAZ-3I MAZ-3IP	MAZ-3D MAZ-3DP MAZ-3I MAZ-3IP	MAZ-3D MAZ-3DP MAZ-3I MAZ-3IP	MAZ-3D MAZ-3DP MAZ-3I MAZ-3IP	MAZ-3D MAZ-3DP MAZ-3I MAZ-3IP
	323	89-92	MAZ-3D MAZ-7D MAZ-7DP	MAZ-3D MAZ-7D MAZ-7DP	MAZ-3D MAZ-7D MAZ-7DP	MAZ-3D MAZ-7D MAZ-7DP	MAZ-3D MAZ-7D MAZ-7DP
	323 MX3 MX5	95 95 95		MAZ-7DP1	MAZ-7DP1	MAZ-7DP1	MAZ-7DP1
	323 B.F.	82	NE-23 NE-26	MAZ-2D MAZ-2DP MAZ-2I MAZ-2IP	MAZ-2D MAZ-2DP MAZ-2I MAZ-2IP	MAZ-2D MAZ-2DP MAZ-2I MAZ-2IP	MAZ-2D MAZ-2DP MAZ-2I MAZ-2IP
	323 S.P. MX5 (EU) MX6	90 90-92 90-92	MAZ-7D MAZ-7DP	MAZ-7D MAZ-7DP	MAZ-7D MAZ-7DP	MAZ-7D MAZ-7DP	MAZ-7D MAZ-7DP
	616 CAPE. 618 RX2 CAPPE. RX3	71-73 71-73 74-77 74-77	DAT-11D DAT-11DP WAS-2P	MAZ-2D MAZ-2DP	MAZ-2D MAZ-2DP		
	616 CAP. 616 SNA RX2 CAPPE.	-70 -70 70-71	DAT-3I	MAZ-2D MAZ-2DP	MAZ-2D MAZ-2DP	MAZ-2D MAZ-2DP	
	626 929	82-87 82-86	MAZ-3D MAZ-3DP MAZ-3I MAZ-6DP MAZ-6P	MAZ-3D MAZ-3DP MAZ-3I MAZ-6DP MAZ-6P	MAZ-3D MAZ-3DP MAZ-3I MAZ-6DP MAZ-6P	MAZ-3D MAZ-3DP MAZ-3I MAZ-6DP MAZ-6P	MAZ-3D MAZ-3DP MAZ-3I MAZ-6DP MAZ-6P
	626	91	MAZ-7D MAZ-7DP MAZ-7DP1	MAZ-7D MAZ-7DP MAZ-7DP1	MAZ-7D MAZ-7DP MAZ-7DP1	MAZ-7D MAZ-7DP MAZ-7DP1	MAZ-7D MAZ-7DP MAZ-7DP1
	626 MX6	91-95 92-95	MAZ-13D MAZ-13DP MAZ-13DP1	MAZ-13D MAZ-13DP MAZ-13DP1	MAZ-13D MAZ-13DP MAZ-13DP1	MAZ-13D MAZ-13DP MAZ-13DP1	MAZ-13D MAZ-13DP MAZ-13DP1
	626 MX6 XEDOS 6	95-97 95-97 95-97		MAZ-13D MAZ-13DP MAZ-13DP1	MAZ-13D MAZ-13DP MAZ-13DP1	MAZ-13D MAZ-13DP MAZ-13DP1	MAZ-13D MAZ-13DP MAZ-13DP1
	626 GL	81	CHR-3 NE-22P2	MAZ-2D MAZ-2DP	MAZ-2D MAZ-2DP	MAZ-2D MAZ-2DP	MAZ-2D MAZ-2DP
	626 S.W. RX7	93-96 91	MAZ-5D MAZ-5DP	MAZ-5D MAZ-5DP	MAZ-5D MAZ-5DP	MAZ-5D MAZ-5DP	MAZ-5D MAZ-5DP
	808 818	71-77 71-77	DAT-11D DAT-11DP	MAZ-2D MAZ-2DP	MAZ-2D MAZ-2DP		

MARCA	MODELO						
			WAS-2P	MAZ-2I MAZ-2IP	MAZ-2I MAZ-2IP		
	818 1.3 818 1.5 1800	-71 -71 71-72	DAT-3I	MAZ-1I	MAZ-1I		
	929	73-80	DAT-11D DAT-11DP WAS-2P	MAZ-2D MAZ-2DP MAZ-2I MAZ-2IP	MAZ-2D MAZ-2DP MAZ-2I MAZ-2IP	MAZ-2D MAZ-2DP MAZ-2I	MAZ-2D MAZ-2DP MAZ-2IP
	929 GLX	87-	MAZ-3D MAZ-3DP MAZ-6DP	MAZ-3D MAZ-3DP MAZ-6DP	MAZ-3D MAZ-3DP MAZ-6DP	MAZ-3D MAZ-3DP MAZ-6DP	MAZ-3D MAZ-3DP MAZ-6DP
	1200 1800	70-72 70-71	DAT-11D DAT-11DP WAS-2P	MAZ-1I	MAZ-1I		
	1600 R 100	72- 70-71	DAT-3I	MAZ-1D	MAZ-1D		
	B 1800	70-71	MAZ-1I	MAZ-1I	MAZ-1I		
	COSMO	75-79	MAZ-16	MAZ-16	MAZ-16	MAZ-16	
	COSMO	80	MAZ-3D MAZ-3DP	MAZ-3D MAZ-3DP	MAZ-3D MAZ-3DP	MAZ-3D MAZ-3DP	MAZ-3D MAZ-3DP
	COSMO	82-83	MAZ-3D MAZ-3DP MAZ-3I MAZ-6P	MAZ-3D MAZ-3DP MAZ-3I MAZ-6P	MAZ-3D MAZ-3DP MAZ-3I MAZ-6P	MAZ-3D MAZ-3DP MAZ-3I MAZ-6P	MAZ-3D MAZ-3DP MAZ-3I MAZ-6P
	E 1600	86	MAZ-2D MAZ-2DP MAZ-2I MAZ-2IP MAZ-3D MAZ-3DP MAZ-3I MAZ-3IP	MAZ-2D MAZ-2DP MAZ-2I MAZ-2IP MAZ-3D MAZ-3DP MAZ-3I MAZ-3IP	MAZ-2D MAZ-2DP MAZ-2I MAZ-2IP MAZ-3D MAZ-3DP MAZ-3I MAZ-3IP		MAZ-2D MAZ-2DP MAZ-2I MAZ-2IP MAZ-3D MAZ-3DP MAZ-3I MAZ-3IP
	EUNOS 800 XEDOS 9	93- 93-96	TOYO-18P	TOYO-18P	TOYO-18P	TOYO-18P	TOYO-18P
	GLC 323	83-89	MAZ-3D MAZ-3DP	MAZ-3D MAZ-3DP	MAZ-3D MAZ-3DP		MAZ-3D MAZ-3DP
	MIATA MX5	89-92 89-92	MAZ-3D MAZ-7D MAZ-7DP MAZ-7DP1	MAZ-3D MAZ-7D MAZ-7DP MAZ-7DP1	MAZ-7D MAZ-7DP MAZ-7DP1	MAZ-7D MAZ-7DP MAZ-7DP1	MAZ-7D MAZ-7DP MAZ-7DP1
	MODELOS	70-74	MAZ-14D	MAZ-14D	MAZ-14D		
	MODELOS	75-84	MAZ-1D	MAZ-2D	MAZ-2D		MAZ-2D



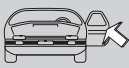



MARCA	MODELO						
			MAZ-1I	MAZ-2DP MAZ-2I MAZ-2IP	MAZ-2DP MAZ-2I MAZ-2IP		MAZ-2DP MAZ-2I MAZ-2IP
	MPV	89-	MAZ-7D MAZ-7DP	MAZ-7D MAZ-7DP	MAZ-7D MAZ-7DP		MAZ-7D MAZ-7DP
	MX3	91-92	MAZ-7D MAZ-7DP MAZ-7DP1	MAZ-7D MAZ-7DP MAZ-7DP1	MAZ-7D MAZ-7DP MAZ-7DP1		MAZ-7D MAZ-7DP MAZ-7DP1
	NAVAJO	91-	MAZ-8D MAZ-8DP	MAZ-8D MAZ-8DP	MAZ-8D MAZ-8DP		MAZ-8D MAZ-8DP
	R 100 R 1200	72- 72-	DAT-11D DAT-11DP WAS-2P	MAZ-1D	MAZ-1D		
	RX2	72-73	DAT-11D DAT-11DP WAS-2P	MAZ-2I MAZ-2IP	MAZ-2I MAZ-2IP	MAZ-2I MAZ-2IP	MAZ-2I MAZ-2IP
	RX4 LUCE RX5 COSMO RX7 COUPE	72-78 72-78 72-78	MAZ-2D MAZ-2DP MAZ-2I MAZ-2IP	MAZ-2D MAZ-2DP MAZ-2I MAZ-2IP	MAZ-2D MAZ-2DP MAZ-2I MAZ-2IP	MAZ-2D MAZ-2DP MAZ-2I MAZ-2IP	
	RX7	83-86	MAZ-3D MAZ-3DP MAZ-6DP	MAZ-3D MAZ-3DP MAZ-6DP	MAZ-3D MAZ-3DP MAZ-6DP	MAZ-3D MAZ-3DP MAZ-6DP	
MERCEDES	180C 200C 220C 280C 300C	93- 93- 93- 93- 93-	ME-7P ME-8P	ME-7P ME-8P	ME-7P	ME-7P	ME-7P
	190 200 230 250 260 280 300 360 380 420 450 500 560 1000	84-86 84- 84- 84- 84- 79- 80- 84- 79- 84- 79- 79- 84- 84-	ME-10P ME-2P ME-3P ME-4P ME-5P ME-6P	ME-10P ME-2P ME-3P ME-4P ME-5P ME-6P	ME-10P ME-2P ME-4P	ME-10P ME-2P ME-4P	ME-10P ME-2P ME-4P
	190	86-	ME-4P ME-5P	ME-4P ME-5P	ME-4P	ME-4P	ME-4P
	190 ALARM	86-92	ME-10P ME-11P ME-12P	ME-10P ME-11P ME-12P	ME-10P	ME-10P	ME-10P

MARCA	MODELO						
	200 220 230 240D 250 280 350 380 450	73-74 73-74 73-74 73-76 73-77 73-74 73- 73-77 73-79	ME-HD ME-HDP ME-HF ME-HFP ME-HM ME-HMP ME-HZ ME-HZP	ME-HD ME-HDP ME-HF ME-HFP ME-HM ME-HMP ME-HZ ME-HZP	ME-HD ME-HDP ME-HF ME-HFP ME-HM ME-HMP ME-HZ ME-HZP	ME-HD ME-HDP ME-HF ME-HFP ME-HM ME-HMP ME-HZ ME-HZP	
	200 220 230 240 280	74-75 74- 74-77 74-77 74-79	ME-HD ME-HDP ME-HZ ME-HZP	ME-HD ME-HDP ME-HZ ME-HZP	ME-HD ME-HDP ME-HZ ME-HZP	ME-HD ME-HDP ME-HZ ME-HZP	
	200	75-76	ME-HF ME-HFP ME-HM ME-HMP	ME-HF ME-HFP ME-HM ME-HMP	ME-HF ME-HFP ME-HM ME-HMP	ME-HF ME-HFP ME-HM ME-HMP	
	200 240D 300D	76-77 76- 76-	ME-HU ME-HUP ME-NU ME-NUP	ME-HU ME-HUP ME-NU ME-NUP	ME-HU ME-HUP ME-NU ME-NUP	ME-HU ME-HUP ME-NU ME-NUP	
	200 230 240 250 300 380	77-84 77-84 77- 77-84 77-80 77-79	ME-HU ME-HUP ME-HY ME-HYP ME-NU ME-NUP ME-NY ME-NYP	ME-HU ME-HUP ME-HY ME-HYP ME-NU ME-NUP ME-NY ME-NYP	ME-HU ME-HUP ME-HY ME-HYP ME-NU ME-NUP ME-NY ME-NYP	ME-HU ME-HUP ME-HY ME-HYP ME-NU ME-NUP ME-NY ME-NYP	
	206D 306D	- -	ME-VA	ME-VA	ME-VA		
	207D 207F 207K 208D 209D	-92 -92 -92 -92 -92	ME-HM ME-HMP	ME-HM ME-HMP	ME-HM ME-HMP		
	220 230 250 280 300 350 7200	-72 -72 -72 -72 -72 -72 -72	ME-HF ME-HFP ME-HZ ME-HZP	ME-HF ME-HFP ME-HZ ME-HZP	ME-HF ME-HFP ME-HZ ME-HZP	ME-HF ME-HFP ME-HZ ME-HZP	
	230 240 280 300 TODO T. 4WD	- - - - -	ME-HF ME-HFP ME-HM ME-HMP ME-HZ	ME-HF ME-HFP ME-HM ME-HMP ME-HZ	ME-HF ME-HFP ME-HM ME-HMP ME-HZ		ME-HF ME-HFP ME-HM ME-HMP ME-HZ



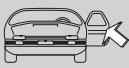



MARCA	MODELO						
			ME-HZP	ME-HZP	ME-HZP		ME-HZP
	307D 308D L 508 L 608 LN 914 MB 308DT MB 408DT U 900 U 1700	-92 92- -91 -91 -91 -91 -91 -91 -91	ME-HM ME-HMP	ME-HM ME-HMP	ME-HM ME-HMP		ME-HM ME-HMP
	400 600	-94 -94	ME-2P ME-3P	ME-2P ME-3P	ME-2P	ME-2P	ME-2P
	711 814 817 917 1117 1300 1500 SPRINTER VARIO	96- 96- 96- 96- 96- 96- 96- 96- 96-	ME-HMP	ME-HMP	ME-HMP	ME-HMP	ME-HMP
	MB 100D	-94	ME-1 ME-1P	ME-1 ME-1P	ME-1 ME-1P		BL-2
	VITO	96-	ME-HMP ME-HZ ME-HZP	ME-HMP ME-HZ ME-HZP	ME-HMP ME-HZ ME-HZP	ME-HMP ME-HZ ME-HZP	ME-HMP
	VITO	97-	ME-HMLP	ME-HMLP	ME-HMLP	ME-HMLP	
MG	MG MGB	70-74 70-74	UN-NH UN-NHP	UN-FS	IN-4 UN-FS		
	MG	75-77	NE-1 NE-1P	UN-FS	UN-FS		
	MG	78-	NE-10 NE-10P	UN-FS UN-FT	UN-FS UN-FT		
	MGB	75-78	NE-1 NE-1P	UN-FS	UN-FT		
	MGB GT	70-75	UN-NH UN-NHP	UN-FS	UN-FS		
	MGF	97	NE-10P	NE-10P	NE-10P		NE-10P
	MODELOS	-70	UN-FP UN-FS	UN-FP UN-FS	UN-FP UN-FS		
MITSUBISHI	3000 GT/R/SL BRAVO COLT CHARIOT	- - 87-93 87-	MIT-12 MIT-7 MIT-7P	MIT-12 MIT-7 MIT-7P	MIT-12 MIT-7 MIT-7P	MIT-12 MIT-7 MIT-7P	MIT-12 MIT-7 MIT-7P

MARCA	MODELO						
	DIAMANTE ECLIPSE ETERNA EXPO GALANT L 200 L 300 LANCER MINICAB MIRAGE MONTERO MX SUPER A.R NIMBUS PAJERO SHOGUN SPACE WAGON S.RUNNER	92- 87- 89- - 87-96 87- 87- 87-96 87- 87-93 92-96 - 87- 92-96 - 85- 92-98					
	CANTER	97	MIT-15P	MIT-15P	MIT-15P	MIT-15P	MIT-15P
	CELESTE COLT GALANT LAMBDA LANCER MINICA STARION	72-80 72-80 72-80 72-80 72-80 72-80 72-80	MIT-1I MIT-1IP	MIT-1I MIT-1IP	MIT-1I MIT-1IP	MIT-1I MIT-1IP	
	COLT CORDIA DEBONAIR ETERNA GALANT L 300 L 300 VAN LANCER MINICA MONTERO PAJERO SAPPORO SHOGUN SIGMA SPACE WAGON STARION VISTA	81-84 81-84 81-84 81-83 81-83 -83 81-84 81-83 81-83 81-92 81-92 81-84 81-84 81-84 81-83 81-83 -93	MIT-2I MIT-2IP	MIT-2I MIT-2IP	MIT-2I MIT-2IP	MIT-2I MIT-2IP	MIT-2I MIT-2IP
	COLT DEBONAIR ETERNA GALANT L 300 LANCER MINICA ORCHID SPACE WAGON STARION TREDIA	84-87 83-85 83-89 83-87 83-87 83-87 83-87 83-85 83-85 83-85 83-85	MIT-3 MIT-3P MIT-4 MIT-4P	MIT-3 MIT-3P MIT-4 MIT-4P	MIT-3 MIT-3P MIT-4 MIT-4P	MIT-3 MIT-3P MIT-4 MIT-4P	MIT-3 MIT-3P MIT-4 MIT-4P



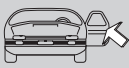



MARCA	MODELO						
	COLT MIRAGE	93-96 93-	MIT-13D MIT-14D MIT-8D MIT-8DP	MIT-13D MIT-14D MIT-8D MIT-8DP	MIT-8D MIT-8DP	MIT-13D MIT-14D MIT-8D MIT-8DP	MIT-8D MIT-8DP
	INTERCOOLER	92-	CHR-17 MIT-12 MIT-7 MIT-7P	CHR-17 MIT-12 MIT-7 MIT-7P	MIT-12 MIT-7 MIT-7P	CHR-17 MIT-12 MIT-7 MIT-7P	MIT-12 MIT-7 MIT-7P
	MODELOS	85-86	MIT-5 MIT-5P MIT-6 MIT-6P	MIT-5 MIT-5P MIT-6 MIT-6P	MIT-5 MIT-5P MIT-6 MIT-6P	MIT-5 MIT-5P MIT-6 MIT-6P	MIT-5 MIT-5P MIT-6 MIT-6P
	PRECIS	86-	HY-3D HY-3DP1	HY-3D HY-3DP1	HY-3D HY-3DP1	HY-3D HY-3DP1	HY-3D HY-3DP1
	SPACE GEAR	95	MIT-12 MIT-7 MIT-7P	MIT-12 MIT-7 MIT-7P	MIT-12 MIT-7 MIT-7P		
	SUMMIT VISTA	93- 93-	MIT-8D MIT-8DP	MIT-8D MIT-8DP	MIT-8D MIT-8DP	MIT-8D MIT-8DP	MIT-8D MIT-8DP
MOSKVITCH	408 412 426 427 2135 2136 2137 2138 2140	- - - - - - - - -	NE-3 NE-3P NE-3P1 NE-3P2	MOS-1 VOL-3	MOS-1 VOL-3		
	2141 ALEKO	-	LA-3D LA-3DP	LA-3D LA-3DP	LA-3D LA-3DP		
NISSAN	200 SX	-83	DAT-12	DAT-12	DAT-12	DAT-12	DAT-12
	240 Z	-83	DAT-6	DAT-6	DAT-6	DAT-6	DAT-6
	280 Z	-83	DAT-6P	DAT-6P	DAT-6P	DAT-6P	DAT-6P
	300 L	-83	DAT-7	DAT-7			
	300 ZX	-83	DAT-7P	DAT-7P			
	AUSTER	-83					
	AXXESS	-83					
	BLUEBIRD	-83					
	CEDRIC	-83					
	CHERRY	-83					
	EXA	-83					
	FAIRLADY	-83					
	GAZELLE	-83					
	GLORIA	-83					
	LANGLEY	-83					
	LAUREL	-83					
LEOPARD	-83						
LIBERTA VIL.	-83						
MARCH	-83						
MAXIMA	-83						

MARCA	MODELO						
	MICRA PAO PINTARA PRAIRE PRESIDENT PULSAR SENTRA SILVIA SKYLINE STANZA SUNNY TULIP VANETTE VIOLET	-83 -83 -83 -83 -83 -83 -83 -83 -83 -83 83-89 -83 -83 -83					
	240 Z 280 Z BLUEBIRD CHERRY SENTRA SKYLINE SUNNY VIOLET	69-73 69-73 77-79 77-79 77-79 77-79 77-79 77-79	DAT-5D	DAT-1D DAT-1DP	DAT-1D DAT-1DP		
	240 Z 260 Z 280 Z 280 ZX ST.W	74-83 74-83 74-83 74-83	DAT-5D	DAT-2D DAT-2DP DAT-2I DAT-2IP	DAT-2D DAT-2DP DAT-2I DAT-2IP	DAT-2D DAT-2DP DAT-2I DAT-2IP	
	1200 DE LUXE 1200 VAN	-71 -71		DAT-4I	DAT-4I		
	1200 DE LUXE	71-72	DAT-8 DAT-8P	DAT-7 DAT-7P	DAT-7 DAT-7P		
	BLUEBIRD CHERRY SENTRA SKYLINE SUNNY VIOLET	70-76 70-76 70-76 70-76 70-76 70-76	DAT-5D	DAT-8 DAT-8I DAT-8IP DAT-8IP1 DAT-8P	DAT-8 DAT-8I DAT-8IP DAT-8IP1 DAT-8P		
	BLUEBIRD	76-79	DAT-1D DAT-1DP DAT-1I DAT-1IP	DAT-1D DAT-1DP DAT-1I DAT-1IP	DAT-1D DAT-1DP DAT-1I DAT-1IP	DAT-1D DAT-1DP DAT-1I DAT-1IP	
	BLUEBIRD	80-82	DAT-9D DAT-9DP DAT-9I DAT-9IP	DAT-9D DAT-9DP DAT-9I DAT-9IP	DAT-9D DAT-9DP DAT-9I DAT-9IP	DAT-9D DAT-9DP DAT-9I DAT-9IP	
	CEDRIC GLORIA PATHFINDER	95-97 95-97 96-97	DAT-15 DAT-15P DAT-16	DAT-15 DAT-15P DAT-16	DAT-15 DAT-15P DAT-16	DAT-15 DAT-15P DAT-16	DAT-15 DAT-15P DAT-16
	CHERRY	80-82	NE-11 NE-11P	DAT-1D DAT-1DP	DAT-1D DAT-1DP	DAT-1D DAT-1DP	



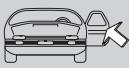



MARCA	MODELO						
				DAT-1I DAT-1IP	DAT-1I DAT-1IP	DAT-1I DAT-1IP	
	FLORIDA PATROL 4x4 SUNNY TERRANO TRADE	89-91 86- 89-91 89-95 89-	DAT-6 DAT-6P	DAT-6 DAT-6P	DAT-6 DAT-6P	DAT-6 DAT-6P	DAT-6 DAT-6P
	MAXIMA	80-82	DAT-2D DAT-2DP DAT-2I DAT-2IP	DAT-2D DAT-2DP DAT-2I DAT-2IP	DAT-2D DAT-2DP DAT-2I DAT-2IP	DAT-2D DAT-2DP DAT-2I DAT-2IP	DAT-2D DAT-2DP DAT-2I DAT-2IP
	MAXIMA	91-95	DAT-10 DAT-10P	DAT-7	DAT-7		DAT-7
	MICRA PRIMERA TERRANO TERRANO II	93-95 91-95 95 93-95	DAT-10 DAT-10P	DAT-10 DAT-10P	DAT-10 DAT-10P	DAT-10 DAT-10P	DAT-10 DAT-10P
	PATHFINDER SENTRA	91- 91-	DAT-12	DAT-12	DAT-12		DAT-12
	PATROL 4 WD	-85	DAT-8 DAT-8P	DAT-8 DAT-8P	DAT-8 DAT-8P	DAT-8 DAT-8P	DAT-8 DAT-8P
	QUEST	93-	FO-8D FO-8DP FO-8DP1	FO-8D FO-8DP FO-8DP1	FO-8D FO-8DP FO-8DP1		FO-8D FO-8DP FO-8DP1
	QUEST	93-94	DAT-19 DAT-19P	DAT-19 DAT-19P	DAT-19 DAT-19P	DAT-19 DAT-19P	DAT-19 DAT-19P
	QUEST	96	DAT-20 DAT-20P	DAT-20 DAT-20P	DAT-20 DAT-20P	DAT-20 DAT-20P	
	SERENA	93-96	DAT-6 DAT-6P1	DAT-6 DAT-6P1	DAT-6 DAT-6P1	DAT-6 DAT-6P1	DAT-6 DAT-6P1
	URVAN	-94	DAT-12	DAT-12 DAT-1D DAT-1DP	DAT-12 DAT-1D DAT-1DP	DAT-12 DAT-1D DAT-1DP	DAT-12 DAT-1D DAT-1DP
	VANETTE	83-96	DAT-12 DAT-6 DAT-6P	DAT-12 DAT-6 DAT-6P	DAT-12 DAT-6 DAT-6P	DAT-12 DAT-6 DAT-6P	DAT-12 DAT-6 DAT-6P
NISSAN (AUSTRALIA)	PINTARA PULSAR	-83 -83	DAT-12 DAT-6 DAT-6P DAT-7 DAT-7P	DAT-12 DAT-6 DAT-6P DAT-7 DAT-7P	DAT-12 DAT-6 DAT-6P	DAT-12 DAT-6 DAT-6P	DAT-12 DAT-6 DAT-6P
NISSAN (USA)	810	80-82	DAT-2D DAT-2DP DAT-2I	DAT-2D DAT-2DP DAT-2I	DAT-2D DAT-2DP DAT-2I	DAT-2D DAT-2DP DAT-2I	DAT-2D DAT-2DP DAT-2I

MARCA	MODELO						
			DAT-2IP	DAT-2IP	DAT-2IP	DAT-2IP	DAT-2IP
	810	83-	DAT-12 DAT-6 DAT-6P DAT-7 DAT-7P	DAT-12 DAT-6 DAT-6P DAT-7 DAT-7P	DAT-12 DAT-6 DAT-6P	DAT-12 DAT-6 DAT-6P	DAT-12 DAT-6 DAT-6P
NSU	RO 80	-			VO-7		
OM IVECO	40	-	AF-9D AF-9DP AF-9I AF-9IP	AF-5D AF-5I AF-6D AF-6I			
	50.10 60.10 65.10 70.10	79-81 79-81 79 79	LF-RO LF-ROP	IMS-3 IMS-3P IMS-5 IMS-5P	IMS-3 IMS-3P IMS-5 IMS-5P		
	50.10 60.10 70.10 75.10 79.10 79.13	81 81 81 81 81 81	SIP-1	IMS-3 IMS-3P IMS-5 IMS-5P	IMS-3 IMS-3P IMS-5 IMS-5P		
	75	-	AF-9D AF-9DP AF-9I AF-9IP FEM-1D FEM-1I	FI-5D FI-5I IMS-3 IMS-3P IMS-5 IMS-5P	FI-5D FI-5I IMS-3 IMS-3P IMS-5 IMS-5P		
	100.13 110.110P 110.13 130	-78 -78 -78 -78	AF-9D AF-9DP AF-9I AF-9IP FEM-1D FEM-1I	IMS-3 IMS-3P IMS-5 IMS-5P			
	100.13 160 160.26	- - -	AF-8D AF-8DP AF-8I AF-8IP AF-9D AF-9DP AF-9I AF-9IP	IMS-3 IMS-3P IMS-5 IMS-5P			
	130 130 R 130 R/H 130 T/H	- - - -	FEM-1D FEM-1I	IMS-3 IMS-3P IMS-5 IMS-5P			
	150 R20 150 T20 150.20	- - -	AF-9D AF-9DP AF-9I	FI-5D FI-5I IMS-3			



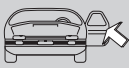



MARCA	MODELO						
	159.20 190 T30 190.30	- - -	AF-9IP	IMS-3P IMS-5 IMS-5P			
	190.35 190.38	- -	AF-7I AF-7IP AF-9D AF-9DP AF-9I AF-9IP	IMS-3 IMS-3P IMS-5 IMS-5P		IMS-12 IMS-3 IMS-3P IMS-5 IMS-5P	
	190.38 TUR.	-	AF-7I AF-7IP AF-9D AF-9DP AF-9I AF-9IP	IMS-3 IMS-3P IMS-5 IMS-5P		IMS-3 IMS-3P IMS-5 IMS-5P	
	330.26 330.35	- -	VO-VB VO-VBP	IMS-3 IMS-3P IMS-5 IMS-5P			
	DAINO 145 LUPETTO	- -	BH-4	AF-5D AF-5I AF-6D AF-6I			
	GRINTA	-	AF-7I AF-7IP FI-9I FI-9IP LF-RO LF-ROP	IMS-3 IMS-3P IMS-5 IMS-5P	IMS-3 IMS-3P IMS-5 IMS-5P		
	LEONCINO	-	BH-4	AF-4D AF-4I			
	ORSETTO	-	FEM-1D FEM-1I	AF-5D AF-5I AF-6D AF-6I			
OPEL-VAUXHALL	ADMIRAL KADETT OLIMPYA REKORD	-73 -73 -73 -73	OP-6 OP-7 OP-8 OP-9 OP-BB OP-EE OP-FF	OP-6 OP-7 OP-8 OP-9 OP-BB OP-EE OP-FF	OP-6 OP-7 OP-8 OP-9 OP-BB OP-EE OP-FF		
	ASCONA MANTA	-74 -74	OP-HA OP-HB OP-HG OP-HH	OP-HA OP-HB OP-HG OP-HH	OP-HA OP-HB OP-HG OP-HH	OP-HA OP-HB OP-HG OP-HH	
	ASCONA MANTA	75-81 75-81	OP-AB OP-ABP	OP-AB OP-ABP	OP-AB OP-ABP	OP-AB OP-ABP	OP-AB OP-ABP

MARCA	MODELO						
			OP-BA OP-BAP OP-J OP-JP	OP-BA OP-BAP OP-J OP-JP	OP-BA OP-BAP OP-J OP-JP	OP-BA OP-BAP OP-J OP-JP	OP-BA OP-BAP OP-J OP-JP
	ASCONA CALIBRA CARAVAN COMMODORE MANTA MONZA OMEGA REKORD VECTRA	82- 87-95 92- 82- 82- 84- 87-95 84- 87-95	OP-WHP OP-WYP	OP-WHP OP-WYP	OP-WHP OP-WYP	OP-WHP OP-WYP	OP-WHP OP-WYP
	ASTRA	91-95	OP-D OP-DKP OP-DP OP-S OP-SKP OP-SP	OP-D OP-DKP OP-DP OP-S OP-SKP OP-SP	OP-D OP-DKP OP-DP OP-S OP-SKP OP-SP	OP-D OP-DKP OP-DP OP-S OP-SKP OP-SP	OP-D OP-DKP OP-DP OP-S OP-SKP OP-SP
	ASTRA VAN COMBO	91-95 -	OP-D OP-DKP OP-DP	OP-D OP-DKP OP-DP	OP-D OP-DKP OP-DP	OP-D OP-DKP OP-DP	
	CORSA CORSA VAN KADETT	84-95 84-95 84-	OP-D OP-DKP OP-DP OP-S OP-SKP OP-SP	OP-D OP-DKP OP-DP OP-S OP-SKP OP-SP	OP-D OP-DKP OP-DP OP-S OP-SKP OP-SP	OP-D OP-DKP OP-DP OP-S OP-SKP OP-SP	
	FRONTERA MONTERREY	92-96 92-	GM-4 GM-4P GM-4P1	GM-4 GM-4P GM-4P1	GM-4 GM-4P GM-4P1	GM-4 GM-4P GM-4P1	GM-4 GM-4P GM-4P1
	KADETT	73-83	OP-AB OP-ABP OP-BA OP-BAP OP-J OP-JP	OP-AB OP-ABP OP-BA OP-BAP OP-J OP-JP	OP-AB OP-ABP OP-BA OP-BAP OP-J OP-JP	OP-AB OP-ABP OP-BA OP-BAP OP-J OP-JP	
	MANTA 1.8	75-79	OP-J OP-JP	OP-J OP-JP	OP-J OP-JP		
	MIDI	92-	MIT-3 MIT-3P	MIT-3 MIT-3P	MIT-3 MIT-3P	MIT-3 MIT-3P	MIT-3 MIT-3P
	MONZA REKORD SENATOR	74-81 74-84 84-	OP-R OP-RP OP-T OP-TP	OP-R OP-RP OP-T OP-TP	OP-R OP-RP OP-T OP-TP	OP-R OP-RP OP-T OP-TP	
	MONZA SENATOR	81-84 81-84	GM-9 GM-9P GM-J	OP-R OP-RP OP-T	OP-R OP-RP OP-T	OP-R OP-RP OP-T	OP-R OP-RP OP-T



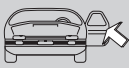



MARCA	MODELO						
			GM-JP	OP-TP	OP-TP	OP-TP	OP-TP
	TIGRA	94	OP-SP1	OP-SP1	OP-SP1		OP-SP1
PEUGEOT	104	72	LMP-1 LMP-1P NE-4 NE-4P NE-4P1	VA-6 VA-6P	VA-6 VA-6P		
	104	78	NE-4 NE-4P NE-4P1	NE-4 NE-4P NE-4P1	LAS-V NE-4 NE-4P NE-4P1		
	104	79	LMP-2 LMP-2P NE-4 NE-4P NE-4P1	LAS-V VA-6 VA-6P	LAS-V VA-6 VA-6P		
	104	80	CHR-3 CHR-3P NE-22P1	CHR-3 CHR-3P NE-22P1	LAS-V VA-6 VA-6P		
	104	81	LMP-4 LMP-4P LMP-5 LMP-5P	LMP-4 LMP-4P LMP-5 LMP-5P	LAS-V VA-6 VA-6P	FAR-1D FAR-1I FAR-2D FAR-2I	
	104 305	82- 83-87	CHR-3 CHR-3P NE-22P1	CHR-3 CHR-3P NE-22P1	VA-18		
	106	91-97	NE-36 NE-36KP1 NE-36P1	NE-36 NE-36KP1 NE-36P1	NE-36 NE-36KP1 NE-36P1	NE-36 NE-36KP1 NE-36P1	NE-36 NE-36KP1 NE-36P1
	106 SERVICE 205 SERVICE	-93 -93	NE-19 NE-20P1	NE-19 NE-20P1	NE-19 NE-20P1	NE-19 NE-20P1	
	204 304 404 504 BERLINA	65- 69-78 65- 68-74	NE-37 NE-37P NE-4 NE-4P NE-4P1	VA-6 VA-6P	VA-6 VA-6P		
	205	84	NE-20 NE-20P NE-29 NE-29P	NE-20 NE-20P NE-29 NE-29P	NE-20 NE-20P NE-29 NE-29P	NE-20 NE-20P NE-29 NE-29P	NE-20 NE-20P NE-29 NE-29P
	205	85-91	NE-20 NE-20P1 NE-29	NE-20 NE-20P1 NE-29	NE-20 NE-20P1 NE-29	NE-20 NE-20P1 NE-29	NE-20 NE-20P1 NE-29
	205 405	91-93 91-93	NE-20 NE-20P1	NE-20 NE-20P1	NE-20 NE-20P1	NE-20 NE-20P1	NE-20 NE-20P1

MARCA	MODELO						
			NE-29 NE-36 NE-36KP1 NE-36P1	NE-29 NE-36 NE-36KP1 NE-36P1	NE-29 NE-36 NE-36KP1 NE-36P1	NE-29 NE-36 NE-36KP1 NE-36P1	NE-29 NE-36 NE-36KP1 NE-36P1
	205 405	93- 93-	NE-20P2 NE-36 NE-36KP1 NE-36P1	NE-20P2 NE-36 NE-36KP1 NE-36P1	NE-20P2 NE-36 NE-36KP1 NE-36P1	NE-20P2 NE-36 NE-36KP1 NE-36P1	NE-20P2 NE-36 NE-36KP1 NE-36P1
	305	78-80	CHR-3 CHR-3P NE-22P1	CHR-3 CHR-3P NE-22P1	LAS-V VA-6 VA-6P	LAS-V PJ-K PJ-KP	
	305	81-82	SIX-1 SIX-1KP SIX-1P1	SIX-1 SIX-1KP SIX-1P1	LAS-V	LAS-V PJ-K PJ-KP	
	305 SERVICE	83-	CHR-3 NE-22P1	CHR-3 NE-22P1	VA-18		
	306	93-97	NE-20P2 NE-36 NE-36KP1	NE-20P2 NE-36 NE-36KP1	NE-20P2 NE-36 NE-36KP1	NE-20P2 NE-36 NE-36KP1	NE-20P2 NE-36 NE-36KP1
	309 405	85- 87-91	NE-20 NE-20P1 NE-29 NE-29P	NE-20 NE-20P1 NE-29 NE-29P	NE-20 NE-20P1 NE-29 NE-29P	NE-20 NE-20P1 NE-29 NE-29P	NE-20 NE-20P1 NE-29 NE-29P
	309 SERVICE 405 AFFAIRE	85- 87-91	NE-19 NE-20P1	NE-19 NE-20P1	NE-19 NE-20P1		
	406	95-97	NE-51P2	NE-51P2	NE-51P2		NE-51P2
	504	75-	NE-4 NE-4P NE-4P1	NE-4 NE-4P NE-4P1	LAS-V		
	504 BREAK	68-74	NE-4 NE-4P NE-4P1	RO-11D	RO-11D		
	504 PICK UP	75-	NE-4 NE-4P1	NE-4 NE-4P1	NE-4 NE-4P1		
	505	79-80	CHR-3 CHR-3P NE-22P1	CHR-3 CHR-3P NE-22P1	LAS-V VA-6 VA-6P	LAS-V VA-6 VA-6P	
	505	84	NE-20 NE-20P	NE-20 NE-20P	NE-20 NE-20P VA-6 VA-6P	NE-20 NE-20P	NE-20 NE-20P
	505	85-	NE-20 NE-20P1 NE-29	NE-20 NE-20P1 NE-29	VA-18	VA-18	VA-18



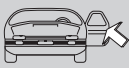



MARCA	MODELO						
	505 BERLINA	81-83	LMP-4 LMP-4P LMP-5 LMP-5P	LMP-4 LMP-4P LMP-5 LMP-5P	LAS-V VA-6 VA-6P	LAS-V VA-6 VA-6P	
	505 BREAK	81-83	CHR-3 CHR-3P NE-22P1	CHR-3 CHR-3P NE-22P1	LAS-V	LAS-V	LAS-V
	505 SERVICE	79-	CHR-3 NE-22P1	LAS-R LAS-V	LAS-R LAS-V		
	604	75-80	NE-4 NE-4P NE-4P1	NE-4 NE-4P NE-4P1	LAS-V	LAS-V	LAS-V
	604	81-	CHR-3 CHR-3P NE-22P1	CHR-3 CHR-3P NE-22P1	VA-6 VA-6P	VA-6 VA-6P	VA-6 VA-6P
	605	90-	NE-34P	NE-34P	NE-34P	NE-34P	NE-34P
	806	94	SIX-3P1	SIX-3P1	SIX-3P1		SIX-3P1
	J-5	-	FI-12 FI-12P3 FI-3D FI-3DP3 FI-6I FI-6IP3	FI-12 FI-12P3 FI-3D FI-3DP3 FI-6I FI-6IP3	FI-12 FI-12P3 FI-3D FI-3DP3 FI-6I FI-6IP3		
	J-7	-	NE-4 NE-4P1				
	J-9	-	NE-4 NE-4P1	RO-4D RO-4I RO-5D RO-5I	RO-4D RO-4I RO-5D RO-5I		
	RANCH	97	SIX-3P1 SIX-3P2	SIX-3P1 SIX-3P2	SIX-3P1 SIX-3P2		SIX-3P1 SIX-3P2
PEUGEOT (ARGEN.)	404	-	NE-3 NE-3P NE-3P2	NE-43	NE-43	GAS-1	NE-43
	405	-	NE-20 NE-20P1	NE-20 NE-20P1	NE-20 NE-20P1		
	504	-	NE-3 NE-3P NE-3P2 NE-4 NE-4P	NE-3 NE-3P NE-3P2 NE-4 NE-4P	NE-43	GAS-1	NE-43
	504 PICK UP	-	NE-4 NE-4P	NE-4 NE-4P		GAS-1	NE-43

MARCA	MODELO						
	505	-	NE-20 NE-20P1 NE-42 NE-42P NE-42P1	NE-20 NE-20P1 NE-42 NE-42P NE-42P1	NE-53		
PIAGGIO	PORTER	93-94	DAI-1P	DAI-1P	DAI-1P		DAI-1P
PORSCHE	911 CARRERA 912 914	70- 70- 70-	PO-HC PO-HCP PO-NC PO-NCP	PO-HC PO-HCP PO-NC PO-NCP	PO-HC PO-HCP		PO-HC PO-HCP
	924 944	75-93 75-93	VO-3KP VO-HV VO-HVP VO-VB VO-VBP	VO-3KP VO-HV VO-HVP VO-VB VO-VBP	VO-3KP VO-HV VO-HVP VO-VB VO-VBP		HU-SU
	928	77-	PO-1P PO-2P	PO-1P PO-2P	PO-1P PO-2P		PO-1P PO-2P
	968	93-	AU-AH VO-2KP VO-AHP	AU-AH VO-2KP VO-AHP	AU-AH VO-2KP VO-AHP		AU-AH VO-2KP VO-AHP
PREMIER	118 NE	-	AF-7I AF-7IP AF-9D AF-9DP FEM-1D FEM-1I FEM-2D FEM-2I FO-FR FO-FRP SIP-2	IMS-3 IMS-3P IMS-5 IMS-5P	IMS-3 IMS-3P IMS-5 IMS-5P		
	PADMINI	-	FEM-1D FEM-1I FEM-2D FEM-2I	AF-4D AF-4I AF-5D AF-5I AF-6D AF-6I	AF-4D AF-4I AF-5D AF-5I AF-6D AF-6I		
RAYTON FISSORE	MAGNUM 4x4 MAGNUM 4x4TD	- -	FI-1 FI-11 FI-11KP FI-11P FI-1P	FI-1 FI-11 FI-11KP FI-11P FI-1P			
	MAGNUM FORZA	-	GIOB-3P	GIOB-3P			
RENAULT	R 4	61-91	NE-4 NE-4P NE-4P1 NE-4P2	NE-4 NE-4P NE-4P1 NE-4P2	NE-4 NE-4P NE-4P1 NE-4P2		



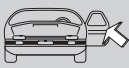



MARCA	MODELO						
	R 5	72-79	LMP-2 LMP-2P NE-15D NE-15DP NE-15I NE-15IP	RO-15 VA-7	RO-15 VA-7	FAB-1	
	R 5	79	NE-15D NE-15DP NE-15I NE-15IP	NE-16 NE-59P	NE-16 NE-59P		
	R 5	80	CHR-3 CHR-3P LMP-4 LMP-4P1	NE-16 NE-59P	NE-16 NE-59P		
	R 5	81	CHR-3 CHR-3P	VA-10	VA-10		
	R 5	82	CHR-3 CHR-3P LMP-4 LMP-4P1 LMP-5 LMP-5P1	VA-10	VA-10		BL-2 LAS-V
	R 5	83-84	CHR-3 CHR-3P	VA-10	VA-10	VA-10	
	R 5	85-86	NE-19 NE-19P1	VA-10	VA-10	VA-10	
	R 5	86-	NE-19 NE-19P1	NE-28	NE-28	NE-28	
	R 6	68-	LMP-1 LMP-1P NE-15I NE-15IP	RO-15	RO-15		
	R 7	-	NE-15I NE-15IP NE-4 NE-4P2	NE-16 NE-4 NE-4P2 NE-59P	NE-16 NE-4 NE-4P2 NE-59P	FAR-1D	
	R 9 R 11	81 81	CHR-3 CHR-3P LMP-5 LMP-5P1	NE-16 NE-59P	NE-16 NE-59P		
	R 9 R 11	82-83 82-83	CHR-3 CHR-3P	BS-5 NE-16 NE-59P VA-10	BS-5 NE-16 NE-59P VA-10	NE-16 NE-59P VA-10	
	R 9	84-	NE-19	NE-16	NE-16	NE-16	VA-17P

MARCA	MODELO						
	R 11	84-	NE-19P	NE-59P VA-10 VA-17P	NE-59P VA-10 VA-17P	NE-59P VA-10 VA-17P	
	R 12	69-71	LMP-1 LMP-1P	RO-15	RO-15		
	R 12	72-	LMP-2 LMP-2P	VA-7	VA-7		
	R 14	76-77	CHR-3 CHR-3P NE-15I NE-15IP	NE-16 NE-59P	NE-16 NE-59P		
	R 14	78-79	CHR-3 CHR-3P	VA-7	VA-7		
	R 14	80-	CHR-3 CHR-3P LMP-4 LMP-4P1 LMP-5 LMP-5P1	NE-16 NE-59P VA-10	NE-16 NE-59P VA-10		
	R 15 R 17	71- 71-	NE-15I NE-15IP	RO-15	RO-15		
	R 16	65-	NE-3 NE-3P1 NE-3P2	RO-15	RO-15		
	R 18 FUEGO	78-80 78-80	CHR-3 CHR-3P	NE-16 NE-59P	NE-16 NE-59P		
	R 18 FUEGO	80-82 82-	CHR-3 CHR-3P LMP-5 LMP-5P1	VA-10	VA-10		
	R 18	83-	CHR-3 CHR-3P NE-19 NE-19P1 NE-22P	VA-10	VA-10	VA-10	
	R 19	88-90	NE-19 NE-19P1	NE-19 NE-19P1	VA-10	VA-10	VA-10
	R 19	90-	NE-19 NE-19P1 NE-36 NE-36KP1 NE-36P1	NE-19 NE-19P1 NE-36 NE-36KP1 NE-36P1	NE-19 NE-19P1 NE-36 NE-36KP1 NE-36P1	NE-19 NE-19P1 NE-36 NE-36KP1 NE-36P1	NE-19 NE-19P1 NE-36 NE-36KP1 NE-36P1
	R 20 R 30	75- 75-	CHR-3 CHR-3P LMP-4	VA-17P	VA-17P	VA-17P	VA-17P



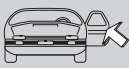



MARCA	MODELO						
			LMP-4P1 NE-22P				
	R 21	86-89	NE-19 NE-19P1	NE-28 VA-10	NE-28 VA-10		NE-28 VA-10
	R 21	90-91	NE-36 NE-36KP1 NE-36P1	NE-36 NE-36KP1 NE-36P1	NE-36 NE-36KP1 NE-36P1	NE-36 NE-36KP1 NE-36P1	NE-36 NE-36KP1 NE-36P1
	R 21 R 25 SAFRANE	92- 92- 92-95	NE-38 NE-38P1	NE-38 NE-38P1	NE-38 NE-38P1	NE-38 NE-38P1	NE-38 NE-38P1
	R 25	83-88	NE-19 NE-19P1	VA-17P	VA-17P	VA-17P	VA-17P
	R 25	89-91	NE-36 NE-36KP1 NE-36P1	VA-17P	VA-17P	VA-17P	VA-17P
	ALPINE	92-	NE-19 NE-19P1	NE-19 NE-19P1	NE-19 NE-19P1	NE-19 NE-19P1	NE-19 NE-19P1
	CLIO	90-98	NE-36 NE-36KP1 NE-36P1 VA-34 VA-34P	NE-36 NE-36KP1 NE-36P1 VA-34 VA-34P	NE-36 NE-36KP1 NE-36P1 VA-34 VA-34P	NE-36 NE-36KP1 NE-36P1 VA-34 VA-34P	NE-36 NE-36KP1 NE-36P1 VA-34 VA-34P
	COACH MEGANE	95-96 95-96	NE-38 NE-38P1	NE-38 NE-38P1	NE-38 NE-38P1		NE-38 NE-38P1
	ESPACE	84-97	NE-19 NE-19P1 NE-36 NE-36KP1 NE-36P1	VA-10	VA-10	VA-10	VA-10
	LAGUNA	94	NE-38 NE-38P1 VA-34 VA-34P	NE-38 NE-38P1 VA-34 VA-34P	NE-38 NE-38P1 VA-34 VA-34P	NE-38 NE-38P1 VA-34 VA-34P	NE-38 NE-38P1 VA-34 VA-34P
	LAGUNA	94-95	VA-34P1	VA-34P1	VA-34P1	VA-34P1	VA-34P1
	LAGUNA 2°se.	94	VA-34 VA-34P	NE-50P	NE-50P		NE-50P
	TWINGO	93-94	NE-36 NE-36KP NE-36P	NE-36 NE-36KP NE-36P	NE-36 NE-36KP NE-36P	NE-36 NE-36KP NE-36P	NE-36 NE-36KP NE-36P
	TWINGO	95	NE-36 NE-36KP NE-36P VA-34P1	NE-36 NE-36KP NE-36P VA-34P1	NE-36 NE-36KP NE-36P VA-34P1	NE-36 NE-36KP NE-36P VA-34P1	NE-36 NE-36KP NE-36P VA-34P1
RENAULT SAVIEM	B 70.35	-87	CHR-3	VA-7	VA-10		

MARCA	MODELO						
	B 70.45 B 90.35	-87 -87	CHR-3P LMP-5 LMP-5P1 NE-22P		VA-7		
	B 70.45 B 80.45 B 90.45 B 90.50 B 110.150 B 110.35	88-92 92- 88-92 88-92 92- 92-	CHR-3 NE-22P	NE-28	NE-28		
	EXPRESS-B-D	-87	NE-19 NE-19P NE-19P1	NE-19 NE-19P NE-19P1	NE-19 NE-19P NE-19P1		LAS-R LAS-V
	EXPRESS-B-D	87-91	NE-19 NE-19P1	NE-28	NE-28		NE-28
	JK 50-60 JK 75-90 JK 110-115	- - -	BH-1 BH-1P	RO-15 RO-4D RO-4I	RO-15 RO-4D RO-4I		
	JP 11 JP 13 JP 13 TU JP 115	- - - -	BH-1 BH-1P	RO-4D RO-4I	RO-4D RO-4I		LAS-R LAS-V
	MASTER P35 D MASTER T30 D MASTER T35 D	-87 -87 -87	CHR-3 CHR-3P LMP-5 LMP-5P1 NE-22P	VA-7	VA-7		NE-28
	MASTER T30 D MASTER T35 D MASTER TURBO	87- 87- 87-	CHR-3 NE-22P	NE-28	NE-28		NE-28
	R 11 CARGO	-91	NE-19 NE-19P1	VA-10	VA-10		PJ-1 PJ-2 PJ-2P
	R 19 TD	-92	NE-19 NE-19P1	NE-19 NE-19P1	VA-10		RO-7D
	R4 F4 C. 850 R4 F4 C.1100	-94 -94	NE-4 NE-4P NE-4P2	NE-4 NE-4P NE-4P2	NE-4 NE-4P NE-4P2		
	SUPERCINCO D	-91	NE-19 NE-19P1	NE-28	NE-28		
	TRAFFIC	-87	CHR-3 CHR-3P NE-22P	RO-17	RO-17		
	TRAFFIC	88-	NE-19 NE-19P	NE-28	NE-28		



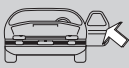



MARCA	MODELO						
RENAULT (ARGEN.)	FUEGO	-	CHR-3 NE-22P	NE-16 NE-59P		NE-16 NE-59P	
	NEVADA	-	CHR-3 NE-22P	NE-28	NE-28		
	R 4	-	NE-3 NE-3P NE-3P2 NE-4 NE-4P NE-4P2	NE-3 NE-3P NE-3P2 NE-4 NE-4P NE-4P2	NE-3 NE-3P NE-3P2 NE-4 NE-4P NE-4P2	GAS-1	
	R 6	-	NE-3 NE-3P NE-3P2	NE-3 NE-3P NE-3P2	NE-3 NE-3P NE-3P2	GAS-1	
	R11 R18	- -	CHR-3 NE-22P	NE-16 NE-59P	NE-16 NE-59P	NE-16 NE-59P	
	R12	-	CHR-3 NE-22P NE-4 NE-4P NE-4P2	CHR-3 NE-22P NE-4 NE-4P NE-4P2	NE-43	GAS-1	
	R19	-	NE-36 NE-36KP1 NE-36P1	NE-36 NE-36KP1 NE-36P1	NE-36 NE-36KP1 NE-36P1		
	R21	-	CHR-3 NE-22P	NE-28 VA-10	NE-28 VA-10		
	TRAFFIC	-	CHR-3 NE-22P	NE-16 NE-53 NE-59P	NE-16 NE-59P	NE-16 NE-53 NE-59P	NE-53
ROLLS ROYCE	ALGUNOS-SOME CLOUD SHADOW	95 -70 -70	YA-20D	YA-20D			
	CLOUD SHADOW	81-97 81-97	YA-21I	YA-21I	YA-21I		YA-21I
	MODELOS	70-73	YA-18D YA-19D YA-20I	YA-18D YA-19D YA-20I	YA-19D		YA-19D
	SHADOW SPIRIT SPUR WRAITH	71-80 71-80 71-80 71-80	YA-21I	YA-20D YA-20I			
	SPIRIT SPUR	80-83 80-83	YA-20I YA-21I	YA-20I YA-21I	YA-21I		YA-21I
ROVER	2000	76-81	LF-RO	LF-RO	FO-E/TC	FO-E/TC	FO-E/TC

MARCA	MODELO						
	2300 2400 2600 3500	76-81 76-81 76-81 76-81	LF-ROP	LF-ROP	FO-E/TCP LF-RO LF-ROP	FO-E/TCP	FO-E/TCP
	2000 2200 2300 2400 2600 3500	82-85 82-85 82-85 82-85 82-85 82-85	LF-RO LF-ROP NE-11 NE-11P	LF-RO LF-ROP NE-11 NE-11P	FO-5 FO-E/TC FO-E/TCP	FO-5 FO-E/TC FO-E/TCP	FO-5 FO-E/TC FO-E/TCP
	2000 2300 2400 2600	85- 85- 85- 85-	LF-RO LF-ROP	LF-RO LF-ROP	FO-E/TC FO-E/TCP	FO-E/TC FO-E/TCP	FO-E/TC FO-E/TCP
	2000 SC/TC 3500	63-75 63-75	LF-9	UN-4	IN-4		
	25	2000	NE-35P2	NE-35P2	NE-35P2		
	3500 V8 S	76-	LF-9 LF-RO LF-ROP	UN-1FS UN-4	IN-4	FO-E/TC FO-E/TCP	FO-E/TC FO-E/TCP
	416 620	95-96 95-96	NE-35P2	NE-35P2	NE-35P2	NE-35P2	NE-35P2
	820 825	92-94 92-94	NE-52P	NE-52P	NE-52P		NE-52P
	ALLEGRO	73-	LF-RO LF-ROP	UN-FT	UN-FT	PJ-2 PJ-2P	
	ALLEGRO 2	73-	LF-BL LF-RO LF-ROP	UN-FT	UN-FT	WAS-1	
	ALLEGRO 3	73-	LF-BL LF-RO LF-ROP NE-11 NE-11P	UN-FT	UN-FT	WAS-1	UN-FT
	FX 4S (TAXI)	-	LF-BL LF-RO LF-ROP	IN-4 IN-5	IN-4 IN-5	UN-FS	
	MAESTRO	83-	NE-11 NE-11P NE-11P1 NE-11P2 NE-24 NE-24P NE-24P1	NE-11 NE-11P NE-11P1 NE-11P2 NE-24 NE-24P NE-24P1	NE-11 NE-11P NE-11P1 NE-11P2 NE-24 NE-24P NE-24P1	PJ-2 PJ-2P	
	MARINA	-	LF-BL	UN-FT	UN-FT		



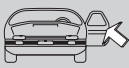



MARCA	MODELO						
			LF-RO LF-ROP NE-1 NE-1P				
	MAXI TRAVELLER	69- 69-	NE-1 NE-1P	UN-FS	UN-FS		
	METRO	80-83	NE-11 NE-11P	NE-14	NE-14	NE-11 NE-11P	
	METRO	84-89	NE-11 NE-11P	NE-14	NE-14	PJ-2 PJ-2P	
	MINI	59-73	UN-FS	UN-FS	UN-FS		
	MINI	74-84	LF-BL LF-RO LF-ROP	UN-FS	UN-FS	PJ-2 PJ-2P	
	MINI	85-	NE-11 NE-11P1 NE-11P2	UN-FS	UN-FS	PJ-K PJ-KP	
	MONTEGO	84-88	NE-11 NE-11P NE-24 NE-24P	NE-14	NE-14	PJ-2 PJ-2P	NE-14
	MONTEGO	88-91	NE-11 NE-11P1 NE-11P2 NE-24 NE-24P1	NE-11 NE-11P1 NE-11P2 NE-24 NE-24P1	NE-11 NE-11P1 NE-11P2 NE-24 NE-24P1	NE-11 NE-11P1 NE-11P2 NE-24 NE-24P1	NE-11 NE-11P1 NE-11P2 NE-24 NE-24P1
	MONTEGO	92-	NE-35 NE-35P	NE-35 NE-35P	NE-35 NE-35P		NE-35 NE-35P
	PRINCESS	-	NE-11 NE-11P	LF-RO LF-ROP	LF-RO LF-ROP	WAS-1	
	SERIE 100	91-93	NE-11 NE-11P1 NE-11P2	NE-11 NE-11P1 NE-11P2	NE-11 NE-11P1 NE-11P2		NE-11 NE-11P1 NE-11P2
	SERIE 200	84	HOND-10 HOND-10P	HOND-10 HOND-10P	HOND-10 HOND-10P	HOND-10 HOND-10P	HOND-10 HOND-10P
	SERIE 200 SERIE 800	85-89 87-91	NE-11 NE-11P NE-11P1 NE-11P2 NE-24 NE-24P NE-24P1	NE-11 NE-11P NE-11P1 NE-11P2 NE-24 NE-24P NE-24P1	NE-11 NE-11P NE-11P1 NE-11P2 NE-24 NE-24P NE-24P1	NE-11 NE-11P NE-11P1 NE-11P2 NE-24 NE-24P NE-24P1	NE-11 NE-11P NE-11P1 NE-11P2 NE-24 NE-24P NE-24P1
	SERIE 200 SERIE 400	89-93 89-93	NE-35 NE-35P2	NE-35 NE-35P2	NE-35 NE-35P2	NE-35 NE-35P2	NE-35 NE-35P2

MARCA	MODELO						
	SHERPA 185 SHERPA 230 SHERPA 255	- - -	LF-BL LF-RO LF-ROP	UN-1FS UN-FT	UN-1FS UN-FT		
SAAB	93	98	SAA-1P1	SAA-1P1	SAA-1P1	SAA-1P1	SAA-1P1
	95 96	- -	AS-1D SAA-AC SAA-ACP	SAA-AC SAA-ACP	SAA-AC SAA-ACP		
	99 900	74-77 74-77	SAA-2P	SAA-2P	SAA-2P		
	900	78-93	SAA-AC SAA-ACP	SAA-AC SAA-ACP	SAA-AC SAA-ACP	SAA-AC SAA-ACP WAS-1	SAA-AC SAA-ACP
	900 9000	93- 86-	SAA-1P1	SAA-1P1	SAA-1P1		SAA-1P1
SEAT	124	70-	FI-9I FI-9IP	IMS-3 IMS-3P IMS-5 IMS-5P	IMS-3 IMS-3P IMS-5 IMS-5P		
	127 131	72- 72-75	FI-9I FI-9IP IMS-7 IMS-7P SIP-3	IMS-3 IMS-3P IMS-5 IMS-5P	IMS-3 IMS-3P IMS-5 IMS-5P	IMS-12 IMS-3 IMS-3P IMS-5 IMS-5P	
	131	75-	CL-7P FI-2D FI-2DP3 FI-3D FI-3DP	CL-7P FI-3D FI-3DP	CL-7P FI-3D FI-3DP		
	132	73-	AF-7I AF-7IP FI-8I FI-8IP FO-FR FO-FRP	IMS-3 IMS-3P IMS-5 IMS-5P	IMS-3 IMS-3P IMS-5 IMS-5P		
	CORDOBA EMELBA IBIZA POKER TOLEDO	93-95 93- 93-95 93- 91-95	AU-AH AU-AHP SE-AHP VO-2 VO-2KP VO-2P	AU-AH AU-AHP SE-AHP VO-2 VO-2KP VO-2P	AU-AH AU-AHP SE-AHP VO-2 VO-2KP VO-2P	AU-AH AU-AHP SE-AHP VO-2 VO-2KP VO-2P	AU-AH AU-AHP SE-AHP VO-2 VO-2KP VO-2P
	EMELBA IBIZA POKER	84-87 84-87 84-87	CL-6 CL-6P	CL-6 CL-6P	CL-6 CL-6P	AF-5D CL-6 CL-6P	
	EMELBA IBIZA	88-92 88-92	AU-HV CL-9P	AU-HV CL-9P	AU-HV CL-9P	AU-HV CL-9P	



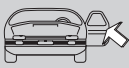



MARCA	MODELO						
	POKER	88-92	VO-3KP VO-HV	VO-3KP VO-HV	VO-3KP VO-HV	VO-3KP VO-HV	
	FURA	72-82	CL-7P FI-3D FI-3DP FI-8I FI-8IP IMS-7 IMS-7P	IMS-3 IMS-3P IMS-5 IMS-5P	IMS-3 IMS-3P IMS-5 IMS-5P	IMS-3 IMS-3P IMS-5 IMS-5P	
	GREDOS (GRE) MALAGA	- 85-90	CL-6 CL-6P	CL-6 CL-6P	CL-6 CL-6P	CL-6 CL-6P	
	MARBELLA	87-92	CL-6 CL-6P	IMS-3 IMS-3P IMS-5 IMS-5P	IMS-3 IMS-3P IMS-5 IMS-5P	IMS-3 IMS-3P IMS-5 IMS-5P	
	MARBELLA	93-97	AU-AH AU-AHP CL-6 CL-6P SE-AHP VO-2 VO-2KP VO-2P	AU-AH AU-AHP CL-6 CL-6P SE-AHP VO-2 VO-2KP VO-2P	AU-AH AU-AHP CL-6 CL-6P SE-AHP VO-2 VO-2KP VO-2P	AU-AH AU-AHP CL-6 CL-6P SE-AHP VO-2 VO-2KP VO-2P	
	PANDA	80-86	FI-8I FI-8IP FI-9I FI-9IP	IMS-3 IMS-3P IMS-5 IMS-5P	IMS-3 IMS-3P IMS-5 IMS-5P		
	RITMO	-	CL-7P FI-3D FI-3DP	CL-7P FI-3D FI-3DP	CL-7P FI-3D FI-3DP		
	RONDA	82-84	CL-7P FI-3D FI-3DP	CL-7P FI-3D FI-3DP	CL-7P FI-3D FI-3DP	CL-7P FI-3D FI-3DP	
	RONDA	85-	CL-6 CL-6P	CL-6 CL-6P	CL-6 CL-6P		
	TERRA	-	CL-6 CL-6P	IMS-3 IMS-3P IMS-5 IMS-5P	IMS-3 IMS-3P IMS-5 IMS-5P		
	TRANS	-	CL-6 CL-6P FI-9I FI-9IP	IMS-3 IMS-3P IMS-5 IMS-5P	IMS-3 IMS-3P IMS-5 IMS-5P		
SKODA	100 105 110 120	82-84 82-84 82-84 82-84	SKO-1 SKO-1P SKO-2				

MARCA	MODELO						
	110 120 130 135 ESTELLE GARD LUXE RAPIDE	85- 85- 85- 85- 85- 85- 85-	SKO-1 SKO-1P				
	FAVORIT FORMAN SILVER	87- 87- 93-	SKO-3I SKO-3IP	SKO-3I SKO-3IP	SKO-3I SKO-3IP	SKO-3I SKO-3IP	
	FELICIA PICK-UP	95 95	SKO-5P	SKO-5P	SKO-5P	SKO-5P	SKO-5P
	MODELOS	64-81	SKO-8	SKO-4			
SSANGYONG	MUSSO	95-	HY-3P2	HY-3P2	HY-3P2	HY-3P2	HY-3P2
STERLING	SERIE 800	-	NE-11 NE-11P NE-24 NE-24P				
STEYR-PUCH	19 S31 19 S37 26 S31 32 S31	-94 -94 -94 -94	NE-58D				
	230 240 280	-79 -79 -79	ME-HZ ME-HZP	ME-HZ ME-HZP	ME-HZ ME-HZP		ME-HZ ME-HZP
	230 240 280	79- 79- 79-	ME-HF ME-HFP ME-HM ME-HMP	ME-HF ME-HFP ME-HM ME-HMP	ME-HM ME-HMP		ME-HM ME-HMP
	300	79-	ME-HZ ME-HZP	ME-HZ ME-HZP	ME-HZ ME-HZP		HU-SU
	PANDA 4x4	83-85	AF-7I AF-7IP FI-9I FI-9IP	IMS-3 IMS-3P IMS-5 IMS-5P	IMS-3 IMS-3P IMS-5 IMS-5P		
	PANDA 4x4	86-88	FI-1 FI-11 FI-11KP FI-11P FI-1P	IMS-3 IMS-3P IMS-5 IMS-5P	IMS-3 IMS-3P IMS-5 IMS-5P		
	PANDA 4x4	89-	FI-1 FI-11 FI-11KP FI-11P FI-1P	FI-1 FI-11 FI-11KP FI-11P FI-1P	FI-1 FI-11 FI-11KP FI-11P FI-1P		

MARCA	MODELO						
SUBARU	ALCYONE	86-	DAT-6	DAT-6	DAT-6	DAT-6	DAT-6
	E10 VAN	86-	DAT-6D	DAT-6D	DAT-6D	DAT-6D	DAT-6D
	E12 VAN	86-	DAT-6DP	DAT-6DP	DAT-6DP	DAT-6DP	DAT-6DP
	E5 VAN	86-	DAT-6DP1	DAT-6DP1	DAT-6DP1	DAT-6DP1	DAT-6DP1
	E7 VAN	86-	DAT-6P	DAT-6P	DAT-6P	DAT-6P	DAT-6P
	HUNTER	86-	DAT-6P1	DAT-6P1	DAT-6P1	DAT-6P1	DAT-6P1
	JUSTY (EU)	86-96					
	L 1.3	86-					
	L 1.6	86-					
	L 1.8	86-					
	LEGACY 4WD	86-96					
	LEONE	86-					
M 70	86-						
M 80	86-						
SAMBAR VAN	86-						
XT	86-						
E10 DOMINGO	84-85	DAT-11D	DAT-8I	DAT-8I			
JUSTY	84-85	DAT-11DP	DAT-8IP	DAT-8IP			
L 1.3	84-85	WAS-2P	DAT-8IP1	DAT-8IP1			
L 1.6	84-85						
L 1.8	84-85						
M 70	84-85						
M 80	84-85						
REX	84-85						
HATCBACK	85-	DAT-6	DAT-6	DAT-6	DAT-6	DAT-6	
JUSTY XT	85-96	DAT-6P	DAT-6P	DAT-6P	DAT-6P	DAT-6P	
LEGACY	85-96	DAT-6P1	DAT-6P1	DAT-6P1	DAT-6P1	DAT-6P1	
LOYALE	85-	DAT-7	DAT-7				
		DAT-7P	DAT-7P				
IMPREZA	95	DAT-6	DAT-6	DAT-6		DAT-6	
		DAT-6P1	DAT-6P1	DAT-6P1		DAT-6P1	
JUSTY	91-96	DAT-6	DAT-7	DAT-7		DAT-7	
		DAT-6P1					
LEONE	73-82	DAT-11D	DAT-1D	DAT-1D	DAT-1D		
REX	73-82	DAT-11DP	DAT-1DP	DAT-1DP	DAT-1DP		
SEDAN	73-82	WAS-2P	DAT-1I	DAT-1I	DAT-1I		
TIGRE	73-82		DAT-1IP	DAT-1IP	DAT-1IP		
			DAT-2D	DAT-2D	DAT-2D		
			DAT-2DP	DAT-2DP	DAT-2DP		
			DAT-2I	DAT-2I	DAT-2I		
			DAT-2IP	DAT-2IP	DAT-2IP		
LEONE	83-84	DAT-11D	DAT-2I	DAT-2I			
REX	83-84	DAT-11DP	DAT-2IP	DAT-2IP			
SEDAN	83-84	WAS-2P					
TIGRE	83-84						
MODELOS	2000	DAT-15	DAT-15	DAT-15	DAT-15	DAT-15	
MODELOS	70-72	DAT-1I	DAT-1I	DAT-1I	DAT-1I	DAT-1I	
		DAT-1IP	DAT-1IP	DAT-1IP	DAT-1IP	DAT-1IP	
				DAT-4I	DAT-4I	DAT-4I	

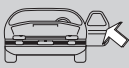
MARCA	MODELO						
SULKY	50 125	-91 -91	BH-4	ZA-1 ZA-1P			
SUNBEAM	1.0 1.3 1.6	- - -	LF-SL LF-SLP	LF-SL LF-SLP	LF-SL LF-SLP	PJ-2 PJ-2P	
SUZUKI	ALTO	76-84	TOYO-14	TOYO-14	TOYO-14	TOYO-14	TOYO-14
	CERVO	76-84	TOYO-14P	TOYO-14P	TOYO-14P	TOYO-14P	TOYO-14P
	CULTUS	76-84					
	ESTEEM	76-84					
	FRONTE	76-84					
	GOLD FINGER	76-84					
	JIMMY	76-84					
	SAMURAI	76-84					
	SJ 30	76-84					
	SJ 310	76-84					
	SJ 410	76-84					
	SJ 413	76-84					
	S.CARRY	88					
VITARA	88						
ALTO	86-95	SUZU-7	SUZU-7	SUZU-7	SUZU-7	SUZU-7	
CERVO	86-	SUZU-7P	SUZU-7P	SUZU-7P	SUZU-7P	SUZU-7P	
CULTUS	86-						
ALTO	96	SUZU-8	SUZU-8	SUZU-8	SUZU-8	SUZU-8	
CARRY VAN	89-91	SUZU-8P	SUZU-8P	SUZU-8P	SUZU-8P	SUZU-8P	
EVERY VAN	89-91						
SWIFT	89-91						
VITARA	89-91						
BALENO	95	SUZU-10	SUZU-10	SUZU-10	SUZU-10		
		SUZU-10P	SUZU-10P	SUZU-10P			
CULTUS	84-91	MIT-2I	MIT-2I	MIT-2I	MIT-2I	MIT-2I	
SAMURAI	84-91	TOYO-14	TOYO-14	TOYO-14	TOYO-14	TOYO-14	
		TOYO-14P	TOYO-14P	TOYO-14P	TOYO-14P	TOYO-14P	
ESCUDO	89-91	SUZU-10	SUZU-10	SUZU-10	SUZU-10	SUZU-10	
SIDEKICK	89-91	SUZU-10P	SUZU-10P	SUZU-10P	SUZU-10P	SUZU-10P	
SWIFT	91-96						
LJ 50	70-	TOYO-14	TOYO-14	TOYO-14	TOYO-14	TOYO-14	
LJ 80	70-	TOYO-14P	TOYO-14P	TOYO-14P	TOYO-14P	TOYO-14P	
		TOYO-K1	TOYO-K1	TOYO-K1	TOYO-K1	TOYO-K1	
		TOYO-K1P	TOYO-K1P	TOYO-K1P	TOYO-K1P	TOYO-K1P	
SAMURAI	92-	TOYO-14	TOYO-14	IMS-11P	IMS-11P	TOYO-14	
		TOYO-14P	TOYO-14P	SUZU-9P	SUZU-9P	TOYO-14P	
SJ 410	85-88	IMS-7	IMS-10	IMS-10	AB-6I		
SJ 413	85-88	IMS-7P					
SJ 410	89-91	IMS-7	IMS-11P	IMS-11P	AB-6I		
SJ 413	89-91	IMS-7P	SUZU-9P	SUZU-9P			







MARCA	MODELO						
	VITARA	91	SUZU-8 SUZU-8P	SUZU-8 SUZU-8P	IMS-11P SUZU-9P	IMS-11P SUZU-9P	SUZU-8 SUZU-8P
TALBOT SIMCA	150	75-	LMP-3	LMP-3	LAS-CR		
	1510	75-	LMP-3P	LMP-3P	LAS-RC		
	ALPINE	75-					
	HORIZON	80-83					
	MINX	80-83					
	OMNI	80-83					
	RAPIER	75-					
	160 GT	79-	CHR-3	CHR-3			
	180	79-	NE-22P2	NE-22P2			
	1000	68-73	NE-3	RO-3	RO-3	PJ-3	
	1005	68-73	NE-3P1			PJ-K	
	1006	68-73	NE-3P2			PJ-KP	
	1007	68-73					
	1100	68-73					
	1501	70-					
1100	74-	CHR-3 NE-22P2	RO-3	RO-3			
1301	70-73	NE-3 NE-3P1 NE-3P2	RO-3	RO-3			
1307	75-	CHR-3	CHR-3	LAS-CR			
1308	75-	NE-22P2	NE-22P2	LAS-RC			
1309	78-						
MURENA	80-						
BAGHEERA	73-	NE-3 NE-3P1 NE-3P2				PJ-1	
HORIZON	77-79	CHR-3	CHR-3	LAS-CR			
HORIZON GL	77-79	NE-22P2	LMP-3	LAS-RC			
MINX	77-79		LMP-3P	VA-16			
OMNI	77-79		NE-22P2	VA-7			
HORIZON	84-	CHR-3	CHR-3	LAS-BT	PJ-2		
MINX	84-	NE-22P2	NE-22P2	LAS-TB	PJ-2P		
OMNI	84-				PJ-K		
					PJ-KP		
RANCH	77-	CHR-3 NE-22P2				PJ-2 PJ-2P	
RAPIER	80-	CHR-3	CHR-3	LAS-CR			
SOLARA	80-	NE-22P2	NE-22P2	LAS-RC			
TAGORA	80-	NE-33P1	NE-33P1				
SAMBA	81-83	CHR-3 NE-22P2 NE-33P1	CHR-3 NE-22P2 NE-33P1	VA-6 VA-6P			

MARCA	MODELO							
	SAMBA	84-	CHR-3 NE-22P2 NE-33P1	CHR-3 NE-22P2 VA-6 VA-6P	VA-6 VA-6P	PJ-2 PJ-2P PJ-K PJ-KP		
TOYOTA	3 DR LIFT B. 4 RUNNER CELICA COROLLA MR2 SUPRA EFI SR TERCEL	88-89 88-89 88-89 88-89 89-90 88-89 89-	TOYO-12 TOYO-12P1 TOYO-8 TOYO-8P	TOYO-12 TOYO-12P1 TOYO-8 TOYO-8P	TOYO-12 TOYO-12P1	TOYO-12 TOYO-12P1	TOYO-12 TOYO-12P1	
	4 RUNNER L. CRUISER	70-86 70-86	TOYO-12 TOYO-12P1 TOYO-2 TOYO-K1 TOYO-K1P	TOYO-12 TOYO-12P1 TOYO-2 TOYO-K1 TOYO-K1P	TOYO-12 TOYO-12P1 TOYO-2 TOYO-K1 TOYO-K1P			
	4 RUNNER CAMRY DYNA LITEACE L. CRUISER RUNNER STARLET VX TURBO	86-88 90-91 90- 90- 86-89 86-89 90-97 86-89	TOYO-16 TOYO-16P TOYO-16P1 TOYO-5 TOYO-5P TOYO-5P1	TOYO-16 TOYO-16P TOYO-16P1 TOYO-5 TOYO-5P TOYO-5P1	TOYO-16 TOYO-16P TOYO-16P1	TOYO-16 TOYO-16P TOYO-16P1	TOYO-16 TOYO-16P TOYO-16P1	TOYO-16 TOYO-16P TOYO-16P1
	4 RUNNER CARINA CELICA COUPE COROLLA CRESSIDA HIACE VAN HILUX VAN L. CRUISER RUNNER	90-91 90-94 91-96 90-91 90- 90- 90- 90-91 90-91	TOYO-20D TOYO-9 TOYO-9P TOYO-9P1	TOYO-20D TOYO-9 TOYO-9P TOYO-9P1	TOYO-20D TOYO-9 TOYO-9P TOYO-9P1	TOYO-20D TOYO-9 TOYO-9P TOYO-9P1	TOYO-20D TOYO-9 TOYO-9P TOYO-9P1	TOYO-20D TOYO-9 TOYO-9P TOYO-9P1
	4 RUNNER CAMRY CARINA S.W. CELICA COROLLA RAV4 RUNNER	91- 91- 95 95 91-96 95 91-	TOYO-15 TOYO-15P	TOYO-15 TOYO-15P	TOYO-15 TOYO-15P			TOYO-15 TOYO-15P
	ARROW CROWN	70-72 70-72	TOYO-4 TOYO-4P	TOYO-4 TOYO-4P				
	CAMRY	84-89	TOYO-13 TOYO-13P1 TOYO-28P	TOYO-13 TOYO-13P1 TOYO-28P	TOYO-13 TOYO-13P1 TOYO-28P	TOYO-13 TOYO-13P1 TOYO-28P	TOYO-13 TOYO-13P1 TOYO-28P	TOYO-13 TOYO-13P1 TOYO-28P
	CAMRY GL CAMRY GLI COROLLA 4DR	84- 84- 86-96	TOYO-3 TOYO-3P TOYO-8 TOYO-8P	TOYO-3 TOYO-3P TOYO-8 TOYO-8P	TOYO-8 TOYO-8P	TOYO-8 TOYO-8P	TOYO-8 TOYO-8P	TOYO-8 TOYO-8P



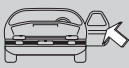



MARCA	MODELO							
	CARINA CELICA COROLLA CORONA CROWN HIACE HILUX MARK II PUBLICA STARLET	72-82 72-82 72-74 72-74 72-82 75-82 73-78 72-82 72-74 72-82	TOYO-14 TOYO-14P TOYO-K1 TOYO-K1P          	TOYO-14 TOYO-14P TOYO-K1 TOYO-K1P          	TOYO-14 TOYO-14P TOYO-K1 TOYO-K1P          	TOYO-14 TOYO-14P TOYO-K1 TOYO-K1P          	TOYO-14 TOYO-14P TOYO-K1 TOYO-K1P          	TOYO-14 TOYO-14P TOYO-K1 TOYO-K1P          
	CARINA COROLLA CORONA CORSA CRESSIDA CRESTA CROWN MARK II MR2 SPRINTER TERCEL	83-85 75-82 83-85 83-85 83-85 83-85 83-85 83-85 83-85 83-85 83-85	TOYO-3 TOYO-3P TOYO-8 TOYO-8P          	TOYO-3 TOYO-3P TOYO-8 TOYO-8P          	TOYO-3 TOYO-3P TOYO-8 TOYO-8P          	TOYO-8 TOYO-8P          	TOYO-8 TOYO-8P          	
	CARINA CORONA SPRINTER TERCEL 4WD	85-86 85-86 85-86 85-86	TOYO-3 TOYO-3P   	TOYO-3 TOYO-3P   	TOYO-3 TOYO-3P   	    	TOYO-3 TOYO-3P   	
	CARINA	94	TOYO-19P	TOYO-19P	TOYO-19P		TOYO-19P	
	CELICA	83-85	TOYO-12 TOYO-12D TOYO-12P1 TOYO-22 TOYO-22D TOYO-3 TOYO-3P TOYO-8 TOYO-8P TOYO-K1 TOYO-K1P	TOYO-12 TOYO-12D TOYO-12P1 TOYO-22 TOYO-22D TOYO-3 TOYO-3P TOYO-8 TOYO-8P TOYO-K1 TOYO-K1P	TOYO-12 TOYO-12D TOYO-12P1 TOYO-22 TOYO-22D TOYO-3 TOYO-3P TOYO-8 TOYO-8P TOYO-8P	TOYO-12 TOYO-12D TOYO-12P1 TOYO-22 TOYO-22D TOYO-8 TOYO-8P	TOYO-12 TOYO-12D TOYO-12P1 TOYO-22 TOYO-22D TOYO-8 TOYO-8P	
	CELICA COROLLA ST TERCEL	86-88 88-89 87-88	TOYO-10 TOYO-10P TOYO-11 TOYO-11P	TOYO-10 TOYO-10P TOYO-11 TOYO-11P	TOYO-10 TOYO-10P   	    	TOYO-10 TOYO-10P   	
	CELICA	90-95	TOYO-10 TOYO-10P TOYO-10P1 TOYO-11 TOYO-11P TOYO-11P1 TOYO-20D TOYO-9 TOYO-9P TOYO-9P1	TOYO-10 TOYO-10P TOYO-10P1 TOYO-11 TOYO-11P TOYO-11P1 TOYO-20D TOYO-9 TOYO-9P TOYO-9P1	TOYO-10 TOYO-10P TOYO-10P1 TOYO-20D TOYO-9 TOYO-9P TOYO-9P1	TOYO-20D TOYO-9 TOYO-9P TOYO-9P1	TOYO-10 TOYO-10P TOYO-10P1 TOYO-20D TOYO-9 TOYO-9P TOYO-9P1	

MARCA	MODELO						
	CELICA 4WD MR2 PREVIA	90-91 90-91 93-97	TOYO-10 TOYO-10P TOYO-10P1 TOYO-11 TOYO-11P TOYO-11P1	TOYO-10 TOYO-10P TOYO-10P1 TOYO-11 TOYO-11P TOYO-11P1	TOYO-10 TOYO-10P TOYO-10P1		TOYO-10 TOYO-10P TOYO-10P1
	CELICA LIFT.	91-96	TOYO-10 TOYO-10P1	TOYO-10 TOYO-10P1	TOYO-10 TOYO-10P1	TOYO-10 TOYO-10P1	TOYO-10 TOYO-10P1
	CELICA SUPRA	82-85	TOYO-4 TOYO-4P	TOYO-4 TOYO-4P	TOYO-4 TOYO-4P	TOYO-4 TOYO-4P	TOYO-4 TOYO-4P
	COROLLA TERCEL	83-87 85-87	TOYO-12 TOYO-12P1 TOYO-22 TOYO-22D TOYO-K1 TOYO-K1P	TOYO-12 TOYO-12P1 TOYO-22 TOYO-22D TOYO-K1 TOYO-K1P	TOYO-12 TOYO-12P1 TOYO-22 TOYO-22D	TOYO-12 TOYO-12P1 TOYO-22 TOYO-22D	TOYO-12 TOYO-12P1 TOYO-22 TOYO-22D
	COROLLA 5	72-76	TOYO-2 TOYO-4 TOYO-4P	TOYO-2 TOYO-4 TOYO-4P	TOYO-4 TOYO-4P	TOYO-4 TOYO-4P	TOYO-4 TOYO-4P
	COROLLA DX	85-96	TOYO-23 TOYO-23P	TOYO-23 TOYO-23P	TOYO-23 TOYO-23P	TOYO-23 TOYO-23P	TOYO-23 TOYO-23P
	COROLLA GT	85-96	TOYO-8 TOYO-8P	TOYO-8 TOYO-8P	TOYO-8 TOYO-8P	TOYO-8 TOYO-8P	TOYO-8 TOYO-8P
	COROLLA SM	73-78	TOYO-14 TOYO-14P TOYO-4 TOYO-4P TOYO-K1 TOYO-K1P	TOYO-14 TOYO-14P TOYO-4 TOYO-4P TOYO-K1 TOYO-K1P	TOYO-14 TOYO-14P TOYO-4 TOYO-4P TOYO-K1 TOYO-K1P		
	COROLLA SW	93-96	TOYO-17 TOYO-17P	TOYO-17 TOYO-17P	TOYO-17 TOYO-17P		TOYO-17 TOYO-17P
	CRESSIDA CRESTA	77-78 77-78	TOYO-23 TOYO-23P	TOYO-23 TOYO-23P	TOYO-23 TOYO-23P		
	CRESSIDA	84-87	TOYO-28P	TOYO-28P	TOYO-28P	TOYO-28P	TOYO-28P
	CRESSIDA	85-87	TOYO-13 TOYO-13P1	TOYO-13 TOYO-13P1	TOYO-13 TOYO-13P1	TOYO-13 TOYO-13P1	TOYO-13 TOYO-13P1
	FX 16	87-88	TOYO-K1 TOYO-K1P	TOYO-K1 TOYO-K1P	TOYO-K1 TOYO-K1P		TOYO-K1 TOYO-K1P
	HDJ 80 L. CRUISER	91- 91-	TOYO-18P	TOYO-18P	TOYO-18P		TOYO-18P
	HILUX 4x4 MR2	95 91-97	TOYO-20D TOYO-9 TOYO-9P TOYO-9P1	TOYO-20D TOYO-9 TOYO-9P TOYO-9P1	TOYO-20D TOYO-9 TOYO-9P TOYO-9P1		TOYO-20D TOYO-9 TOYO-9P TOYO-9P1



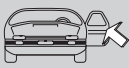



MARCA	MODELO						
	PASEO	91-97	TOYO-10 TOYO-10P TOYO-10P1	TOYO-10 TOYO-10P TOYO-10P1	TOYO-10 TOYO-10P TOYO-10P1		TOYO-10 TOYO-10P TOYO-10P1
	STARLET	84-90	TOYO-K1 TOYO-K1P	TOYO-K1 TOYO-K1P	TOYO-K1 TOYO-K1P	TOYO-K1 TOYO-K1P	TOYO-K1 TOYO-K1P
	VARIOS	70-	TOYO-29	TOYO-29	TOYO-29		
	VARIOS	-69	TOYO-25	TOYO-25			
TRABANT	TODOS	-	DOB-1 DOB-1D DOB-2 DOB-2D DOB-3 DOB-3D	DOB-1 DOB-1D DOB-2 DOB-2D DOB-3 DOB-3D	DOB-1 DOB-1D DOB-2 DOB-2D DOB-3 DOB-3D		
TRIUMPH	ACCLAIM	81-	HOND-1 HOND-1P HOND-2 HOND-2P	HOND-1 HOND-1P HOND-2 HOND-2P	HOND-1 HOND-1P HOND-2 HOND-2P	HOND-1 HOND-1P	HOND-1 HOND-1P
	DOLOMITE TOLEDO	73- 73-	UN-NH UN-NHP	UN-FS	UN-FS		
	GT6 MK3	-	FO-FR FO-FRP UN-NH UN-NHP WAS-2P	UN-NH UN-NHP	UN-NH UN-NHP		
	GTX MK3 SPITFIRE SPITFIRE MK4	72 72-74 72	FO-FR FO-FRP WAS-2P	UN-NH UN-NHP	UN-FT		
	MODELOS	-69	UN-FS	UN-44 UN-FP	UN-44 UN-FP		
	SPITFIRE	74-78	LF-WB LF-WBP	UN-NH UN-NHP	UN-NH UN-NHP		
	SPITFIRE	79-	UN-NH UN-NHP				
	TR6 PJ SPID.	69-77	FO-FR FO-FRP WAS-2P	UN-FT UN-NH UN-NHP	UN-FT		
	TR7 COUPE TR7 SPIDER	75-81 75-81	UN-NH UN-NHP	UN-FT UN-NH UN-NHP	UN-FT		
UAZ	452 469 469 DIESEL	- - -	BH-1 BH-1P VOL-2 VOL-3	IMS-3 IMS-3P IMS-5 IMS-5P	AF-5D		

MARCA	MODELO						
				VOL-2 VOL-3			
	FURGON 4R.M	-	VOL-2	IMS-3 IMS-3P IMS-5 IMS-5P			
	ROAD MASTER	-	BS-6				
VAUXHALL	ASTRA CHEVRETTE	75-79 75-79	OP-J OP-JP	OP-J OP-JP	OP-J OP-JP		
	ASTRA ASTRAMAX BELMONT NOVA	84-95 84- 84- 84-	OP-D OP-DKP OP-DP OP-S OP-SKP OP-SP	OP-D OP-DKP OP-DP OP-S OP-SKP OP-SP	OP-D OP-DKP OP-DP OP-S OP-SKP OP-SP	OP-D OP-DKP OP-DP OP-S OP-SKP OP-SP	
	CARLTON VICEROY	78-81 78-89	OP-R OP-RP OP-T OP-TP	OP-R OP-RP OP-T OP-TP	OP-R OP-RP OP-T OP-TP		
	CARLTON CAVALIER SENATOR	82- 82- 82-	OP-WHP OP-WYP	OP-WHP OP-WYP	OP-WHP OP-WYP	OP-WHP OP-WYP	OP-WHP OP-WYP
	CAVALIER	75-81	OP-AB OP-ABP OP-BA OP-BAP OP-J OP-JP	OP-AB OP-ABP OP-BA OP-BAP OP-J OP-JP	OP-AB OP-ABP OP-BA OP-BAP OP-J OP-JP		OP-AB OP-ABP OP-BA OP-BAP OP-J OP-JP
	FIRENZA	-	LF-RO LF-ROP	LF-6	LF-6		
	ROYALE	84-	OP-D OP-DKP OP-DP OP-S OP-SKP OP-SP	OP-D OP-DKP OP-DP OP-S OP-SKP OP-SP	OP-D OP-DKP OP-DP OP-S OP-SKP OP-SP	OP-D OP-DKP OP-DP OP-S OP-SKP OP-SP	OP-D OP-DKP OP-DP OP-S OP-SKP OP-SP
	VAUXHALL						
VOLGA	GAZ 024	-	VOL-1 VOL-1P	VOL-1 VOL-1P	VOL-1 VOL-1P		
	GAZ 029	-	NE-3 NE-3P NE-3P2	VOL-1 VOL-1P VOL-2 VOL-2D VOL-3	VOL-1 VOL-1P VOL-2 VOL-2D VOL-3		
	GAZ 3110	-	NE-3 NE-3P NE-3P2	VOL-1 VOL-1P VOL-4	VOL-1 VOL-1P VOL-4		



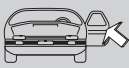



MARCA	MODELO						
				VOL-5P	VOL-5P		
VOLKSWAGEN	411 412 1500 1600 BRASILIA	70-72 70-72 70-72 70-72 70-72	VO-K				
	411 412 BRASILIA IGALA	73-74 73-74 73-74 73-74	VO-VB VO-VBP	VO-VB VO-VBP	VO-VB VO-VBP		HU-SU
	1303 CABRIO	70-	HU-SU	VO-M VO-MP	VO-M VO-MP		
	ALL STAR CALIFORNIA CLUB VAN SINCRO TRANSPORTER	91- 91- 91- 91- 91-95	VO-2 VO-2KP VO-2P	VO-2 VO-2KP VO-2P	VO-2 VO-2KP VO-2P	VO-2 VO-2KP VO-2P	VO-2 VO-2KP VO-2P
	BEETLE EL VOLKSWAGE ESCARABAJO FUSCA	70-78 70-78 70-78 70-78	VO-M VO-MP	VO-M VO-MP	VO-M VO-MP		HU-SU
	CABRIOLET	75-81	VO-VB VO-VBP	VO-VB VO-VBP	VO-VB VO-VBP		BL-2 FO-PN HU-SU
	CADDY	-	AU-1 AU-HV AU-HVP VO-3KP VO-HV VO-HVP	AU-1 AU-HV AU-HVP VO-3KP VO-HV VO-HVP	AU-1 AU-HV AU-HVP VO-3KP VO-HV VO-HVP		
	CORRADO GOLF JETTA ATLAN. PASSAT VENTO	88- 88-90 88- 88-95 92-95	AU-AN AU-ANP HU-AN VO-2 VO-2KP VO-2P	AU-AN AU-ANP HU-AN VO-2 VO-2KP VO-2P	VO-2 VO-2KP VO-2P		VO-2 VO-2KP VO-2P
	DERBY AMAZON FAMILCAR GOLF PASSAT POLO	77-80 77-80 77-80 77-80 77-80	VO-VB VO-VBP	VO-VB VO-VBP	VO-VB VO-VBP	BL-II PJ-1 PJ-2 PJ-2P	
	DERBY AMAZON GOLF GOLF CABRIO JETTA ATLAN. PASSAT SANTANA SCIROCCO	81-82 81-82 81-84 81-84 81-84 81-82 81-82	AU-1 AU-HV AU-HVP VO-3KP VO-HV VO-HVP VO-VB	AU-1 AU-HV AU-HVP VO-3KP VO-HV VO-HVP VO-VB	AU-1 AU-HV AU-HVP VO-3KP VO-HV VO-HVP VO-VB	AU-1 AU-HV AU-HVP BL-2 VO-3KP VO-HV VO-HVP VO-HVP	AU-1 AU-HV AU-HVP VO-3KP VO-HV VO-HVP

MARCA	MODELO						
			VO-VBP	VO-VBP			
	DERBY AMAZON GOLF JETTA ATLAN. PASSAT POLO SCIROCCO	85-87 85-87 85-87 85-87 85-91 85-87	AU-1 AU-HV AU-HVP VO-3KP VO-HV VO-HVP VO-VB VO-VBP	AU-1 AU-HV AU-HVP VO-3KP VO-HV VO-HVP VO-VB VO-VBP	AU-1 AU-HV AU-HVP VO-3KP VO-HV VO-HVP	AU-1 AU-HV AU-HVP BL-1I BL-2 FO-PN VO-3KP VO-HV VO-HVP	
	GOLF	75-77	VO-VB VO-VBP	HU-SU VO-VB VO-VBP	HU-SU VO-VB VO-VBP		VO-VB VO-VBP
	GOLF	87-88	VO-2 VO-2KP VO-2P VO-AHP	VO-2 VO-2KP VO-2P VO-AHP	VO-2 VO-2KP VO-2P VO-AHP	VO-2 VO-2KP VO-2P VO-AHP	VO-2 VO-2KP VO-2P VO-AHP
	GOLF	91-95	AU-AN AU-ANP HU-AN VO-2 VO-2KP VO-2P	AU-AN AU-ANP HU-AN VO-2 VO-2KP VO-2P	VO-2 VO-2KP VO-2P	AU-AN AU-ANP HU-AN VO-2 VO-2KP VO-2P	VO-2 VO-2KP VO-2P
	K 70 K 70 LS	70-73 70-73	FO-PN VO-VB VO-VBP	FO-PN VO-VB VO-VBP	FO-PN VO-VB VO-VBP		
	LT 28D LT 31 TL 31 TL 45 TL 50	70-79 70-79 70-79 70-79 70-79	VO-R VO-RP	VO-R VO-RP	VO-R VO-RP		HU-SU
	MODELOS	66-69	FO-D VO-L	VO-L			HU-SU
	PASSAT	73	VO-VB VO-VBP	VO-VB VO-VBP	FO-PN		
	PASSAT FAM.	73-76	VO-R VO-RP	VO-R VO-RP	VO-R VO-RP		
	POLO	75-76	VO-VB VO-VBP	VO-VB VO-VBP	AU-W		
	POLO	81-82	AU-1 AU-HV AU-HVP VO-3KP VO-HV VO-HVP	AU-1 AU-HV AU-HVP VO-3KP VO-HV VO-HVP	AU-1 AU-HV AU-HVP VO-3KP VO-HV VO-HVP	AU-1 AU-HV AU-HVP BL-1I VO-3KP VO-HV VO-HVP	AU-1 AU-HV AU-HVP VO-3KP VO-HV VO-HVP

MARCA	MODELO						
	POLO	91-95	VO-2 VO-2KP VO-2P	VO-2 VO-2KP VO-2P	VO-2 VO-2KP VO-2P	BL-2	BL-2
	SCIROCCO	75-81	VO-VB VO-VBP	VO-VB VO-VBP	VO-VB VO-VBP	BL-1I PJ-1 PJ-2 PJ-2P	VO-VB VO-VBP
	TARO NISSAN	89-	TOYO-20D TOYO-9 TOYO-9P TOYO-9P1	TOYO-20D TOYO-9 TOYO-9P TOYO-9P1			
	TL 31 TL 35 TL 45 TL 50 TRANSPORTER VAGON	80- 80- 80- 80- 80-91 80-	VO-N VO-NP	VO-N VO-NP	VO-N VO-NP		VO-N VO-NP
VOLKSWAGEN (ARGEN.)	1500 1800	80- 80-			CHR-12	WAS-1	
	1500	-		CHR-8 CHR-8P			
	GACEL	-	VO-4KP VO-FHP1	VO-4KP VO-FHP1		GAS-1	
	GOL	-95	VO-4KP VO-FHP1 VO-VB VO-VBP	VO-4KP VO-FHP1 VO-VB VO-VBP	VO-4KP VO-FHP1 VO-VB VO-VBP	CLI-1D	
	GOL	96	VO-2DP	VO-2DP	VO-2DP	VO-6D	
	GOL	97-	VO-8P	VO-8P	VO-8P		
	KOMBI	-	VO-R VO-RP	VO-R VO-RP		GAS-1	
	POINTER	-	VO-5P	VO-5P	VO-5P		
	SAVEIRO	-	VO-3KP VO-HV VO-HVP VO-VB VO-VBP	VO-3KP VO-HV VO-HVP VO-VB VO-VBP	VO-3KP VO-HV VO-HVP VO-VB VO-VBP	CLI-1D VO-6D	
	SENDA	-	VO-3KP VO-HV VO-HVP	VO-3KP VO-HV VO-HVP		CLI-1D GAS-1	
VOLKSWAGEN (BRASIL)	FOX GOL	75-76 75-76	VO-VB VO-VBP	VO-VB VO-VBP	AU-W		
	FOX	77-80	VO-VB	VO-VB	VO-VB	BL-1I	

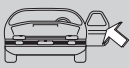
MARCA	MODELO						
	GOL PARATI QUANTUM	77-80 77-80 77-80	VO-VBP	VO-VBP	VO-VBP	PJ-1 PJ-2 PJ-2P	
	FOX GOL	81-82 81-82	AU-1 AU-HV AU-HVP VO-3KP VO-HV VO-HVP	AU-1 AU-HV AU-HVP VO-3KP VO-HV VO-HVP	AU-1 AU-HV AU-HVP VO-3KP VO-HV VO-HVP	AU-1 AU-HV AU-HVP BL-1I VO-3KP VO-HV VO-HVP	AU-1 AU-HV AU-HVP VO-3KP VO-HV VO-HVP
	FOX GOL PARATI QUANTUM	85-91 85-91 85-87 85-87	AU-1 AU-HV AU-HVP VO-3KP VO-HV VO-HVP VO-VB VO-VBP	AU-1 AU-HV AU-HVP VO-3KP VO-HV VO-HVP VO-VB VO-VBP	AU-1 AU-HV AU-HVP VO-3KP VO-HV VO-HVP	AU-1 AU-HV AU-HVP BL-1I BL-2 FO-PN VO-3KP VO-HV VO-HVP	
	FOX GOL	91- 91-	VO-2 VO-2KP VO-2P	VO-2 VO-2KP VO-2P	VO-2 VO-2KP VO-2P	BL-2	BL-2
	PARATI QUANTUM	73 73	VO-VB VO-VBP	VO-VB VO-VBP	FO-PN		
	PARATI QUANTUM SANTANA	81-84 81-84 81-82	AU-1 AU-HV AU-HVP VO-3KP VO-HV VO-HVP VO-VB VO-VBP	AU-1 AU-HV AU-HVP VO-3KP VO-HV VO-HVP VO-VB VO-VBP	AU-1 AU-HV AU-HVP VO-3KP VO-HV VO-HVP	AU-1 AU-HV AU-HVP BL-2 VO-3KP VO-HV VO-HVP	AU-1 AU-HV AU-HVP VO-3KP VO-HV VO-HVP
	PARATI QUANTUM	88- 88-	AU-AN AU-ANP HU-AN VO-2 VO-2KP VO-2P	AU-AN AU-ANP HU-AN VO-2 VO-2KP VO-2P	VO-2 VO-2KP VO-2P		VO-2 VO-2KP VO-2P
	VARIOS	96-	VO-2DP1 VO-2P1 VO-8P1	VO-2DP1 VO-2P1 VO-8P1	VO-2DP1 VO-2P1 VO-8P1		VO-2DP1 VO-2P1 VO-8P1
VOLKSWAGEN (CHINA)	SHANGHAI	73	VO-VB VO-VBP	VO-VB VO-VBP	FO-PN		
	SHANGHAI	77-80	VO-VB VO-VBP	VO-VB VO-VBP	VO-VB VO-VBP	BL-1I PJ-1 PJ-2 PJ-2P	
	SHANGHAI	81-84	AU-1	AU-1	AU-1	AU-1	AU-1

MARCA	MODELO						
			AU-HV AU-HVP VO-3KP VO-HV VO-HVP VO-VB VO-VBP	AU-HV AU-HVP VO-3KP VO-HV VO-HVP VO-VB VO-VBP	AU-HV AU-HVP VO-3KP VO-HV VO-HVP	AU-HV AU-HVP BL-2 VO-3KP VO-HV VO-HVP	AU-HV AU-HVP VO-3KP VO-HV VO-HVP
	SHANGHAI	85-87	AU-1 AU-HV AU-HVP VO-3KP VO-HV VO-HVP VO-VB VO-VBP	AU-1 AU-HV AU-HVP VO-3KP VO-HV VO-HVP VO-VB VO-VBP	AU-1 AU-HV AU-HVP VO-3KP VO-HV VO-HVP	AU-1 AU-HV AU-HVP BL-1I BL-2 FO-PN VO-3KP VO-HV VO-HVP	
	SHANGHAI	88-	AU-AN AU-ANP HU-AN VO-2 VO-2KP VO-2P	AU-AN AU-ANP HU-AN VO-2 VO-2KP VO-2P	VO-2 VO-2KP VO-2P		VO-2 VO-2KP VO-2P
VOLKSWAGEN (MEXICO)	ESCARABAJO	-	VO-M VO-MP	VO-M VO-MP	VO-M VO-MP		HU-SU
VOLVO	66 DL 66 GL 66 L 66 MARATHON 66 SL	72-76 72-76 72-76 72-76 72-76		FO-5	FO-5		
	142 144 145 164	68-72 68-72 68-72 68-72	NE-13	UN-FR	UN-FR		
	142 144 145 164 240 242 244 264	73-76 73-76 73-76 73-76 73-76 73-76 73-76 73-76	NE-10 NE-10P	NE-9 NE-9P WAS-1	NE-9 NE-9P WAS-1	WAS-1	
	240 242 244 245 246 262 264 265	77-78 77-78 77-78 77-78 77-78 77-78 77-78 77-78	NE-12 NE-12P	NE-9 NE-9P	NE-9 NE-9P	NE-9 NE-9P	NE-9 NE-9P
	240	78-84	NE-12	NE-12	NE-9	NE-9	NE-9

MARCA	MODELO						
	242 244 245 262 264 265	78-83 78-83 78-83 78-83 78-83 78-83	NE-12P	NE-12P	NE-9P	NE-9P	NE-9P
	240	84-85	NE-12 NE-12P NE-18 NE-18P	NE-12 NE-12P NE-18 NE-18P	NE-18 NE-18P	NE-18 NE-18P	NE-18 NE-18P
	340 343 345 360	76-84 76-84 76-84 76-84	HU-DF HU-DFP HU-DFP1	AKS-1	AKS-1	NE-21P	AKS-1
	340 360	85-86 85-86	HU-DF HU-DFP HU-DFP1	HU-DF HU-DFP HU-DFP1	HU-DF HU-DFP HU-DFP1		
	440 460 480	87- 87- 87-	HU-DHP HU-DNP	HU-DHP HU-DNP	HU-DHP		HU-DHP
	740 760 780 940	86-91 84-87 86-91 91-96	NE-12 NE-12P NE-18 NE-18P	NE-12 NE-12P NE-18 NE-18P	NE-18 NE-18P		NE-18 NE-18P
	760 762 764 765 960	91- 91- 91- 91- 91-96	NE-40 NE-40P NE-41P	NE-40 NE-40P NE-41P	NE-40 NE-40P		NE-40 NE-40P
	850	91-96	NE-40 NE-40P	NE-40 NE-40P	NE-40 NE-40P		NE-40 NE-40P
	AMAZON 140	-73	NE-13 NE-56	UN-4 UN-FP UN-FS	UN-4 UN-FP UN-FS		
	FH 12	97	HU-DHP	HU-DHP			HU-DHP
	PV AMAZON	-	AS-11 AS-24	HUD-1	HUD-1		
WARTBURG	MODELOS	-	DOB-1 DOB-1D DOB-2 DOB-2D DOB-3 DOB-3D	DOB-1 DOB-1D DOB-2 DOB-2D DOB-3 DOB-3D	DOB-1 DOB-1D DOB-2 DOB-2D DOB-3 DOB-3D		
YUGO-ZASTAVA	101 311 411	71-82 71-82 71-82	FO-FR FO-FRP	IMS-3 IMS-3P IMS-5	IMS-3 IMS-3P IMS-5		

MARCA	MODELO						
	413 511 513	71-82 71-82 71-82		IMS-5P	IMS-5P		
	KORAL YUGO 45 YUGO 55 YUGO 65	87- 87- 87- 87-	FI-6I FI-6IP3	FI-3D FI-3DP FI-3DP5	FI-3D FI-3DP FI-3DP5		
	YUGO 45 YUGO 55	82-84 82-84	FI-6I FI-6IP3 FO-E/TC FO-E/TCP FO-FR FO-FRP	FI-6I FI-6IP3 IMS-3 IMS-3P IMS-5 IMS-5P SIP-1	IMS-3 IMS-3P IMS-5 IMS-5P		
	YUGO 45 YUGO 55 YUGO 65	85-86 85-86 85-86	FI-6I FI-6IP3	YU-1D	YU-1D		
	YUGO 45 YUGO 55 YUGO 65	86-87 86-87 86-87	FI-6I FI-6IP3	IMS-3 IMS-3P IMS-5 IMS-5P	IMS-3 IMS-3P IMS-5 IMS-5P		
ZAZ	966 968 A 968 M	- - -	NE-3 NE-3P NE-3P1 NE-3P2	VOL-3	VOL-3		
	TAVRIA	-	NE-3 NE-3P NE-3P1 NE-3P2	AF-19 AF-19P	AF-19 AF-19P		



**JMA**  **JMA**

**CAMIÓN**

**KAMIOIA**

**TRUCKS**





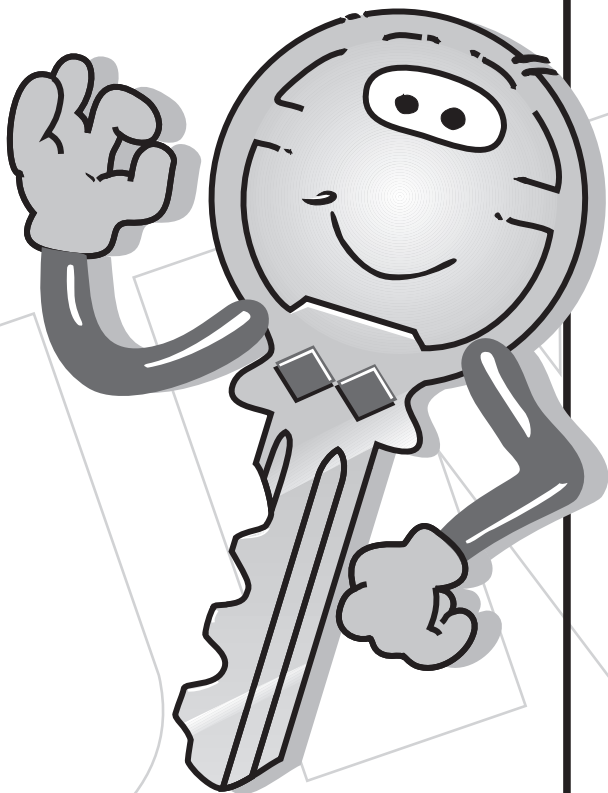

**CAMION**

**LKW**



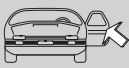



**CAMION**





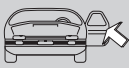



MARCA	MODELO						
ASTRA	BM 64.26 BM 64.30 BM 64.36 BM 66.30 BM 66.36 BM 201 BM 305	- - - - - - -	AF-7I AF-7IP AF-8D AF-8DP AF-8I AF-8IP AF-9D AF-9DP AF-9I AF-9IP	IMS-3 IMS-3P IMS-5 IMS-5P			
BEDFORD	CF	-80	LF-9 LF-RO LF-ROP NE-10 NE-10P	UN-1FS	UN-1FS		
	CF CF 2 250 D CF 2 350 D	80- 80- 80-	NE-10 NE-10P	UN-FT WAS-6 WAS-6P	UN-FT WAS-6 WAS-6P		
	TL 560 TL 860 TL 1260 TM	- - - -	NE-1 NE-10 NE-10P NE-1P	LF-6			
BROCKWAY	VARIOS	66-	BS-4D YA-8D YA-8I	BS-4D YA-8D YA-8I			BS-4D HUD-1 YA-8D YA-8I
DAF	2800 3600 FA 2100 DT FA 2105 FA 2505 FA 2805 FA 3605 FAS 3605 FAT 2826 FAT 3626 FT 2505 FT 2805 FT 3605 FTT 2826 FTT 3626	- - - - - - - - - - - - - - -	CHR-3 CHR-3P	FO-OA	FO-OA		
	2800 T. IN. FA 1100 FA 1300 T FA 2100 FA 2500	-84 80-82 80-82 80-82 80-82	NE-3 NE-3P NE-3P1 NE-3P2	FO-OA	FO-OA		
	F 1100 F 1300 F 1700 F 1900 F 2100	85-91 85-91 85-91 85-91 85-91	CHR-3 NE-22P2	FO-OA	FO-OA		

MARCA	MODELO						
	F 2500 F 3626	85-91 85-91					
	FA 1100 DT FA 1300 DNT FA 1300 DT FA 2100 FA 2500	- - - 82-84 82-84	DAV-1 DAV-1P	RO-4D RO-4I	RO-4D RO-4I		LAS-V
	FA 2500	-	CHR-3 CHR-3P NE-3 NE-3P NE-3P1 NE-3P2	FO-OA	FO-OA		
	FT 75.270R FT 85.360W FT 3300	- - -	CHR-3 NE-22P	VO-VB VO-VBP	VO-VB VO-VBP		
	F-FA-V- 600 F-FA-V- 800 F-FA-V-1000	85-91 85-91 85-91	NE-11 NE-11P	FO-OA	FO-OA	WAS-6 WAS-6P	
	SERIE FT	91-	CHR-3 CHR-3P	VO-VB VO-VBP	VO-VB VO-VBP		
	V 400 V 600	91- 91-	NE-11 NE-11P	NE-11 NE-11P	NE-11 NE-11P	WAS-4 WAS-4P	
DIAMOND REO	VARIOS	60-	HUD-1	HUD-1			HUD-1
FIAT IVECO	30.8 35.10 35.8 40.10 49.10	-91 -91 -91 -91 -91	FI-11 FI-11KP FI-11P FI-1P	FI-11 FI-11KP FI-11P FI-1P	FI-11 FI-11KP FI-11P FI-1P		FIS-1D
	30.8 35.10 35.12 35.8 40.10	92- 92- 92- 92- 92-	FI-12 FI-12P1	FI-11 FI-11KP FI-11P	FI-11 FI-11KP FI-11P		
	40 NC 35 40.8 F 8	- -	AF-9D AF-9DP AF-9I AF-9IP	AF-5D AF-5I AF-6D AF-6I	AF-5D AF-5I AF-6D AF-6I		
	50 NC 55 55 NC 80 NC	- - - 79-	AF-9D AF-9DP AF-9I AF-9IP FEM-1D FEM-1I	IMS-3 IMS-3P IMS-5 IMS-5P	IMS-3 IMS-3P IMS-5 IMS-5P		
	50.10 F 10 55.8 F 8	79- 79-	LF-RO LF-ROP	IMS-3 IMS-3P	IMS-3 IMS-3P		



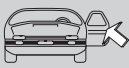



MARCA	MODELO						
	60.10 F 10 65.10 F 10 70.10 F 10 79.10 F 10 79.13 F 13 79.14 F 14 80.13 F 13 95.14 F 14 100	79- 79- 79- 79- 79- 79- 79- 79- 79-	SIP-1	IMS-5 IMS-5P	IMS-5 IMS-5P		
	50.9 60.11 65.12 79.14 80.14 95.14 109.14 110.17	-94 -94 -94 -94 -94 -94 -94 -94	FI-6I FI-6IP1 FI-9I FI-9IP	IMS-3 IMS-3P IMS-5 IMS-5P	IMS-3 IMS-3P IMS-5 IMS-5P		
	100 110 110 NC 110 P 130 150.20 160 NC 170 NC 35	81- 81- 81- 81- 81- 81- 81- 81-	AF-8D AF-8DP AF-8I AF-8IP AF-9D AF-9DP AF-9I AF-9IP FEM-1D FEM-1I	IMS-3 IMS-3P IMS-5 IMS-5P	IMS-3 IMS-3P IMS-5 IMS-5P		
	115.17 D T. 115.17 H 135 145.17 H T. 175.24	-89 -89 -89 -89 -89	FI-6I FI-6IP	FI-6I FI-6IP	FI-6I FI-6IP		
	150 R.20 150 T.20 159.20 190 190 T.30 190.26	- - - -89 -89 -89	AF-9D AF-9DP AF-9I AF-9IP	FI-5D FI-5I IMS-3 IMS-3P IMS-5 IMS-5P			
	180 180.26 180.26 T 190.38 190.38 T 190.F 35 190.H 35	-89 -89 -89 -89 -89 -89 -89	AF-7I AF-7IP AF-9D AF-9DP AF-9I AF-9IP	IMS-3 IMS-3P IMS-5 IMS-5P	IMS-3 IMS-3P IMS-5 IMS-5P	IMS-3 IMS-3P IMS-5 IMS-5P	
	190 PC 26 260	- -	BH-2	PRE-1I			
	190 TURBOS.	89-91	AU-1 AU-HV AU-HVP	FI-11 FI-11KP FI-11P		BL-2	FIS-1D

MARCA	MODELO						
	190.26 190.30 190.32 190.36 190.42 190.48 240.26 240.32 240.36 280.36 330.30 330.35 330.36	-91 -91 -91 -91 -91 -91 -91 -91 -91 -91 -91 -91 -91	FI-11 FI-11KP FI-11P	NE-1 NE-1P			
	190.26 190.30 190.32 190.36 190.42 190.48 240.26 240.32 240.36 280.36 330.30 330.35 330.36	92- 92- 92- 92- 92- 92- 92- 92- 92- 92- 92- 92- 92-	FI-11 FI-11KP FI-11P	FI-11 FI-11KP FI-11P	FI-11 FI-11KP FI-11P		
	190.30	-89	AF-7I AF-7IP AF-9D AF-9DP AF-9I AF-9IP	FI-5D FI-5I IMS-3 IMS-3P IMS-5 IMS-5P	IMS-3 IMS-3P IMS-5 IMS-5P	IMS-3 IMS-3P IMS-5 IMS-5P	
	190.33 T.S. 190.38 T.S. 190.42 T.S.	-88 -88 -88	VO-VB VO-VBP	FI-11 FI-11KP FI-11P	IMS-5 IMS-5P	BL-2	
	242 E-15 242 E-18	85- 85-	FI-3D FI-3DP3	IMS-3 IMS-3P IMS-5 IMS-5P	IMS-3 IMS-3P IMS-5 IMS-5P		
	242.15 242.18	-84 -84	CT-1 CT-1P CT-3 CT-3P	IMS-3 IMS-3P IMS-5 IMS-5P	IMS-3 IMS-3P IMS-5 IMS-5P		
	260.36 260.48	92- 92-	FI-11 FI-11KP FI-11P	VO-VB VO-VBP	VO-VB VO-VBP	VO-1	
	330 F 35 330.26 330.30 330.32 330.35	-88 -88 -88 -88 -88	VO-VB VO-VBP	IMS-3 IMS-3P IMS-5 IMS-5P			



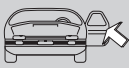



MARCA	MODELO						
	330.36	-88					
	619.3A 619.N 642	- - -	AF-9D AF-9DP AF-9I AF-9IP	AF-9D AF-9DP AF-9I AF-9IP			
	643 672	- -	AF-9D AF-9DP FEM-1D FEM-1I	AF-5D AF-5I AF-6D AF-6I			
FORD	A 0406 A 0406 R A 0509 A 0509 P A 0609 D 710 CUSTOM	- - - - - -	FO-E/TC FO-E/TCP FO-TX FO-TXKP FO-TXP UN-FT	UN-FT	UN-FT		UN-FP UN-FS
	CARGO	86-91	NE-11P3		NE-11P3		
	TRANSCONTIN.	-	LF-6	LAS-R LAS-V	LAS-R LAS-V		UN-FS
FORD (USA)	CARGO	86-	NE-11P3	NE-11P3			
	MODELOS	-73	MAZ-14D	MAZ-14D	MAZ-14D		
	MODELOS	74-84	MAZ-1D MAZ-1I	MAZ-1D MAZ-1I	MAZ-1D MAZ-1I		
	MODELOS	86-87	NE-11 NE-11P	LF-WR	LF-WR		UN-FT
	MODELOS	87-88	FO-11D FO-20D	FO-11D FO-20D	FO-11D FO-20D		FO-11D FO-20D
	MODELOS	88-95	NE-11 NE-11P	NE-11 NE-11P			UN-FT
	MODELOS	96-97	FO-15D FO-15DP	FO-15D FO-15DP	FO-15D FO-15DP		FO-15D FO-15DP
FREIGHTLINER	VARIOS	-	BS-4D HUD-1 YA-8D	BS-4D HUD-1 YA-8D	BS-4D HUD-1 YA-8D		BS-4D HUD-1 YA-8D
GM (CHEVROLET)	MODELOS	72-80	TOYO-2	TOYO-2	TOYO-2		TOYO-2
	MODELOS	81-82	MIT-1I MIT-1IP MIT-2I MIT-2IP	MIT-1I MIT-1IP MIT-2I MIT-2IP	MIT-1I MIT-1IP MIT-2I MIT-2IP		MIT-1I MIT-1IP MIT-2I MIT-2IP
GM (GMC)	MEDIUM TRUCK W4	84-86 84-86	DAT-6D DAT-6DP1	DAT-6D DAT-6DP1	DAT-6D DAT-6DP1		DAT-6D DAT-6DP1
	MEDIUM	86-	ISU-2	ISU-2			

MARCA	MODELO						
	TILTMAS- TRUCK W4	86- 86-					
HINO	MODELOS	76-	TOYO-K1 TOYO-K1P	TOYO-K1 TOYO-K1P	TOYO-K1 TOYO-K1P		
ISUZU	TILTMAS- W4-W5 (S.N)	86-88 86-88	DAT-6D DAT-6DP1 ISU-1 ISU-2	DAT-6D DAT-6DP1 ISU-1 ISU-2	MIT-1I MIT-1IP		DAT-6D DAT-6DP1 ISU-1 ISU-2
KENWORTH	MIDRANGER	88-	NE-11 NE-11P	NE-11 NE-11P	NE-11 NE-11P		FO-PN
MACK	MIDLINER	82-	BH-1 BH-1P DAV-1 DAV-1P	RO-4I	RO-4I		
	MODELOS	55-86	BS-1I YA-11D	BS-1I YA-11D	BS-1I YA-11D		BS-1I YA-11D
MAGIRUS DEUTZ	90 M 5.3 90 M 6.0 90 M 6.6 90 M 7 90 M 9 130 M 11 130 M 13 130 M 16 130 M 9 160 M 13	- - - - - - - - - -	BH-1 BH-1P	RO-4D RO-4I	RO-4D RO-4I		LAS-R LAS-V
	260 360 D 18	- -	BH-2	PRE-1I	PRE-1I		
MAN	6.100 F 6.90 F 8.136 F 8.90 F 9.136 9.136 F 9.136 FAE 9.150 F 10.136 10.150 F	- - - - - - - - - -	VO-R VO-RP	VO-R VO-RP	VO-R VO-RP		BL-2 FO-PN HU-SC
	12.170 12.192 FKT 12.192 F-FT 12.232 FT 14.192 F 14.232 FKT 14.232 FT 17.232 F 18.272 FTI 19.240 F 19.262 F	- - - - - - - - - - -	BH-1 BH-1P	HU-MN HU-MNP	HU-MN HU-MNP		

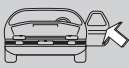

MARCA	MODELO						
			AU-HVP VO-3KP VO-HV VO-HVP	NE-22P1			NE-22P1
	620	-	CHR-3 CHR-3P	VO-VB VO-VBP			
	1236	-	CHR-5	IMS-5 IMS-5P		BL-2	
PIAGGIO	APE CAR APE CAR P3 P 601	- - -	AF-9D AF-9DP AF-9I AF-9IP FAB-1 FEM-1D FEM-1I	FAB-1	FAB-1	FAB-1	
	APE P 50 APE TM P 50	- -	FEM-1D FEM-1I NE-6 NE-6P				
	APE TM 703 NICA 125	- -	AF-9D AF-9DP AF-9I AF-9IP FAB-1	FAB-1	FAB-1	FAB-1	
RENAULT SAVIEM	B 70.35 B 70.45 B 90.35	-87 -87 -87	CHR-3 CHR-3P LMP-5 LMP-5P1 NE-22P	VA-7	VA-10 VA-7		
	B 70.45 B 80.45 B 90.45 B 90.50 B 110.150 B 110.35	88-92 92- 88-92 88-92 92- 92-	CHR-3 NE-22P	NE-28	NE-28		
	G 300 G G 330 GV G 340 TI GR 305 GR 305 TURBO R 310 R 360 R 360 TURBO	-94 -94 -94 -94 -94 84 84-85 84	DAV-1 DAV-1P NE-3 NE-3P NE-3P1 NE-3P2	LAS-R LAS-V			PJ-1 PJ-2 PJ-2P
	GB 119 GB 231 TURBO GC 231 TURBO GF 231 TURBO GR 231 TURBO	86 86 86 86 86	DAV-1 DAV-1P	RO-4D RO-4I			LAS-R LAS-V

MARCA	MODELO						
	JK 50-60 JK 75-90 JK 110-115	- - -	BH-1 BH-1P	RO-15 RO-4D RO-4I	RO-15 RO-4D RO-4I		
	JP 11 JP 13 JP 13 TU JP 115	- - - -	BH-1 BH-1P	RO-4D RO-4I	RO-4D RO-4I		LAS-R LAS-V
	M 160.12 M 200.12 M 230.12 M 230.13T M 230.16	-94 -94 -94 -94 -94	NE-3 NE-3P NE-3P2	VA-10		RO-4D RO-4I	VA-10
	MASTER P35 D MASTER T30 D MASTER T35 D	-87 -87 -87	CHR-3 CHR-3P LMP-5 LMP-5P1 NE-22P	VA-7	VA-7		NE-28
	MASTER T30 D MASTER T35 D MASTER TURBO	87- 87- 87-	CHR-3 NE-22P	NE-28	NE-28		NE-28
	R 350 TI R 365 R 380 R 385 R 420 RI 357	-92 -92 -92 -94 -92 -92	NE-3 NE-3P NE-3P2	VA-10			VA-10
	R 360 R 370 R 370 T U8 T	85-87 85-87 85-87	NE-3 NE-3P NE-3P2	LAS-R LAS-V			RO-7D
	S 100.06 S 100.07 S 100.08 T S 150 S 160.08 T S 160.09 S 170.13 S 170.145	-94 -94 -94 -94 -94 -94 -94 -94	NE-3 NE-3P NE-3P2	RO-4I	NE-28	PJ-2 PJ-2P	LAS-R
	SC2/35-40 SC3/35-40 SC4/35-40	- - -	BH-1 BH-1P	LAS-R LAS-V	RO-17		
	TRAFFIC	-87	CHR-3 CHR-3P NE-22P	RO-17	RO-17		
	TRAFFIC	88-	NE-19 NE-19P	NE-28	NE-28		
ROVER	LEYLAND ROAD	-	NE-11 NE-11P	LAS-V	UN-1FS		LAS-V

MARCA	MODELO						
SCANIA	110 111 140 8V T 141 411 8V	- - - - -	BH-2 FO-FR FO-FRP WAS-2P	HU-SX			
	112 H 142 H 8V P 82 P 92 P 93 H-HL P 93 ML P 113 EL R 112 H R 113 E-ES R 113 HL-HS R 113 M R 113 MA R 142 E R 142 H R 142 H 8V R 142 M R 143 EL-ES R 143 HL-HS R 143 MA	-87 -87 -87 -87 88- 88- 88- -87 88- 88- 88- 88- -87 -87 -87 -87 88- 88- 88-	VO-VB VO-VBP	WIT-1			
	R-144 NA	96-	HU-2P	HU-2P			
STEYR PUCH	10 S 14 17 S 18	- -	VO-VB VO-VBP	AKS-1		BL-2	
	19 S 31 19 S 37 26 S 31 32 S 31	- - - -	NE-25				
TRUCK (USA)	MODELOS	95	GM-14 GM-14P GM-25 GM-25P	GM-14 GM-14P GM-25 GM-25P	GM-14 GM-14P GM-25 GM-25P		GM-14 GM-14P GM-25 GM-25P
VOLKSWAGEN	MODELOS	81-84	VO-VB VO-VBP	VO-VB VO-VBP			VO-VB VO-VBP
	MODELOS	84-	VO-2KP VO-3KP VO-HV VO-HVP VO-VB VO-VBP	VO-2KP VO-3KP VO-HV VO-HVP VO-VB VO-VBP			VO-2KP VO-3KP VO-HV VO-HVP VO-VB VO-VBP
VOLVO	F 6 F 7 F 10 F 12 T 6	- - - -	NE-12 NE-12P	NE-12 NE-12P			NE-9 NE-9P WAS-1
	F 1020 T 6	-	NE-3	NE-12			NE-9

MARCA	MODELO						
			NE-3P NE-3P2	NE-12P			NE-9P WAS-1
	FL 6 INTER. FL 7 INTER. FL 10 INTER. FL 12 INTER.	- - - -	NE-12 NE-12P	RO-4D RO-4I			LAS-R LAS-V
	FL 611 FL 614 FL 616	- - -	NE-12 NE-12P				
	MODELOS	-87	NE-1 NE-1P	NE-1 NE-1P			
WHITE	VARIOS	-80	BS-4D HUD-1	BS-4D HUD-1			BS-4D HUD-1
	VARIOS	-89	BS-2 BS-5	BS-2 BS-5			BS-2 BS-5



**JMA** 

**MOTOCICLETA**

**MOTOZIKLETA**

**MOTORCYCLE**







**MOTOCYCLETTE**

**MOTORRAD**







**MOTOCICLETTA**















MARCA	MODELO						
APRILIA	AFI 50	86-91	ZA-1	ZA-1			
	AFI 125	86-91	ZA-1P	ZA-1P			
	AS 125 R.V.	86-91					
	ET 50	86-91					
	ETX 125 PV	86-91					
	ETX 350	86-					
	ETX 600	86-					
	MX 125 A	86-91					
	RED ROSE 50	86-90					
	RED ROSE 125	86-90					
AMICO	96-	ZA-6DP1	ZA-6DP1			ZA-6DP1	
CLASSIC 125	96-						
GULLIVER	96-						
LEONARDO	96-						
MOTO 6.5	96-						
PEGASO	96-						
PEGASO 3-650	96-						
RALLY	96-						
RX 50	96-						
SR 50	96-						
AMICO 50	92-	ZA-4DP	ZA-4DP			ZA-4DP	
EUROPA 50	92-						
FUTURA 50AE	92-						
PEGASO 50	92-						
PEGASO 600	90-						
PEGASO 650	90-						
RED ROSE 50	92-						
RS 50 EXTRE.	92-						
RX 50	92-96						
SR 50	92-96						
ATLANTIC 125	2003	ZA-9P1	ZA-9P1	ZA-9P1	ZA-9P1	ZA-9P1	
CLIMBER 280	94-	ZA-4DP	ZA-4DP				
EUROPA 125	94-						
FUTURA 50	90-91						
PEGASO 125	94-						
RED ROSE 125	94-						
RX 125 EXT.	94-						
RX 125 REP.	94-						
SIX DAYS RX	90-91						
TUAREG R. 50	94-						
EUROPA 125AE	92-	ZA-1	ZA-1			ZA-1	
EXTREMA 125	93-	ZA-1P	ZA-1P			ZA-1P	
PEGASO 125	93-94						
RED ROSE 125	93-94						
RX 125	92-						
TUAREG 125	86-						
FILO GT 4L	-	AF-8D					
MX 250	-	AF-8DP					
RC 250	-	AF-8I					
		AF-8IP					
		FEM-2D					
		FEM-2I					







MARCA	MODELO						
	FUTURA 50AE RX 50	90-91 90-91	ZA-13P				
	FUTURA 125 REPLICA 50	90-91 90-91	ZA-2P				
	RALLY 125 RX 125	90-91 90-91	ZA-1 ZA-1P	NE-8			
	RED ROSE 50	90-91	FI-11 FI-11KP FI-11P ZA-2P	ZA-1 ZA-1P			
	TUAREG 125	92-	ZA-2P	ZA-2P			ZA-2P
	TUAREG 250 TUAREG 350 TUAREG 600	86- 86- 86-	ZA-1 ZA-13P ZA-1P	NE-8			
ATALA	BYTE AT10-50 GREEN HAKER	96 96 96	ZA-4DP	ZA-4DP			ZA-4DP
BENELLI	124 125 TURISMO	- -	FEM-1D FEM-1I				
	125 SPORT	82-83		NE-8	NE-8		
	125 SPORT T 125	83-84 -	FEM-2D FEM-2I	NE-6 NE-6P		NE-6 NE-6P	
	125 SPORT 125 TURISMO	84- 84-	FEM-2D FEM-2I	NE-8			
	250 2C 304 4C 354 654 750 SEI 900 SEI	- - - - - -		ZA-1 ZA-1P	ZA-1 ZA-1P		
	EXPORT 3V G2 MAGNUM 3V MOTORELLA 50	- - - -		ZA-1 ZA-1P			
	LASER S 50 S 125	- 85- -		ZA-1 ZA-1P		ZA-1 ZA-1P	
BETA	50 CC	-93	AF-5I	ZA-1 ZA-1P			
	CHRONO CHRONO 502 QUADRA	95 95 95	ZA-4DP		ZA-4DP		ZA-4DP







MARCA	MODELO						
	TEMPO	95					
	KR 50 KR 125 KR 250 VRS 50	- - - -	FAB-1	FAB-1			
	QUADRA TEMPO	96- 96-	ZA-6DP1	ZA-6DP1			ZA-6DP1
BICICLETTE-CYCLES	MOD.DANES DK MOD.SUECO S	- -		AS-17D AS-21 AS-21D AS-2D AS-2I			
	RALEIGH	-		LF-2 UN-FP			
BIMOTA	GPI 1	90-	ZA-1 ZA-1P	ZA-1 ZA-1P			
	HB 2 HB 3 HB 3/S	- - -	NE-6 NE-6P	NE-6 NE-6P		FAR-1D FAR-1I	
	KB 1 KB 2/TT	- -	SUZU-13P SUZU-4I SUZU-4IP	NE-6 NE-6P			
	SB 2	-	SUZU-13P SUZU-4I SUZU-4IP				
	SB 3 SB 4S SB 4SP	- - -	SUZU-5 SUZU-5P	NE-6 NE-6P		SUZU-5 SUZU-5P	
BMA	AMICA 50 AMICA 125 AMICA 250 AMICA 360	- - - -	AF-9D AF-9DP AF-9I AF-9IP FEM-1D FEM-1I	UN-MRN			
BMW	400 RS	84-85	NE-6 NE-6P	NE-6 NE-6P	NE-6 NE-6P	NE-6 NE-6P	
	450 650 K 1 K 75 K 75 RT K 75 S K 100 K 100 RS K 1100 LT K 1100 RS	84-86 84-86 87-93 84-92 93- 93- 84-92 93- 93-94 93-94	NE-7	NE-7	NE-7	NE-7	







MARCA	MODELO						
	R 45 R 65 R 80 R 80 GS R 80 R R 80 RT R 100 GS R 100 R R 100 RS R 100 RT	84-86 84-92 84- 93- 93- 93- 93- 93- 93- 93-					
	F 650	94-	ZA-6DP				
	K 1100 K 1100 LS K 1100 LT R 1100 R 1100 GS R 1100 R R 1100 RT	94-95 94- 94- 94-95 94- 94- 94-	BM-HBP1	BM-HBP1	BM-HBP1	BM-HBP1	
	K 1100 R 1000 R 1100	95 95 95	BM-HBP1	BM-HBP1	BM-HBP1	BM-HBP1	BM-HBP1
	R 60/6 R 75/6 R 80/7 R 90 S R 90/6	- - - - -	NE-7	NE-6 NE-6P		NE-6 NE-6P	
	R 60/7 R 75/7 R 100 RS R 100/7 R 100/S	- - - - -	NE-7	NE-6 NE-6P		BL-2	
CAGIVA	125 ALETA COCIS 50	86- -91		ZA-1 ZA-1P			
	200 ELEFANT 350 ALA CRESTA 350 DG 350 SST 350 RL SX 350	84- 84-87 84-87 84-87 84-87 84-87		ZA-1 ZA-1P		ZA-1 ZA-1P	ZA-1 ZA-1P
	650	-	SUZU-13P SUZU-4I SUZU-4IP	SUZU-13P SUZU-4I SUZU-4IP			
	900 ELEFANT	97	KAW-6P		KAW-6P	KAW-6P	
	ALETA EL.125 RX 250 SST 250 ALA SST 250 RL SX 250	- 84- 84- 84- 84-		ZA-1 ZA-1P	ZA-1 ZA-1P	ZA-1 ZA-1P	ZA-1 ZA-1P







MARCA	MODELO						
	SXT 250 WMX 250 WMX 500	84- 84- 84-					
	ALETA ORO L.	86-	FI-6I FI-6IP2 FI-6IP3	ZA-1 ZA-1P		ZA-1 ZA-1P	
	ALETA ROSA K 3	86- 91-92	SUZU-13P SUZU-4I SUZU-4IP	ZA-1 ZA-1P			
	AR 350 ELEFA. 2 125 ELEFA. 2 200 ELEFA. 2 350 ELEFA. 2 600	84-89 - -84 84-89 -	SUZU-13P SUZU-4I SUZU-4IP	ZA-1 ZA-1P	ZA-1 ZA-1P		
	BLUES 125 FRECCIA 125 TAMANACO 125	- - -	FI-1 FI-1P	FI-1 FI-1P	ZA-1 ZA-1P		
	CITY ELEFA. 900 MITO MITO 125 MITO CARENA. MITO EV MITO LAWSON MITO RACING PRIMA SUPER CITY	93-94 92- 92- 91-92 91-92 94-95 93- 91-94 93- 93-	KAW-6P	KAW-6P	KAW-6P		
	CITY CITY LUCKY CITY PASSING SUPERCITY	94- 94- 94- 94-	ZA-8P	ZA-8P			
	ELEFA. 90 ELEFA. 750 LUCKY 350 E. PARIS DAKAR T 350 E T4 350 R	-91 -91 87-91 -91 87-91 87-91	FI-1 FI-1P	ZA-1 ZA-1P	ZA-1 ZA-1P	ZA-1 ZA-1P	ZA-1 ZA-1P
	FRECCIA 125 N 90	91-92 91-92	FI-1 FI-1P	ZA-1 ZA-1P			
	FULL FUN 125 MITO 125 MMX 125	-90 -90 -90	FI-1 FI-1P	FI-1 FI-1P	FI-1 FI-1P		
	HD 175 HD 350	- -	FEM-1D FEM-1I				
	LUCKY 350 EX T4 350 T4 500 E	-91 -91 -91	FI-1 FI-1P	ZA-1 ZA-1P	ZA-1 ZA-1P		

MARCA	MODELO						
	MITO RACING	94	KAW-6P	KAW-6P	KAW-6P	KAW-6P	KAW-6P
	RIVER 600 C.	95	ZA-4DP			ZA-4DP	
	RIVER 600 C.	95-	ZA-4DP			ZA-4DP	FIS-1D
	ROADSTER 125	94	ZA-1 ZA-1P		ZA-1 ZA-1P	ZA-1 ZA-1P	ZA-1 ZA-1P
	SST 125 SXT 125 N W 8	84- 84- 94	SUZU-13P SUZU-4I SUZU-4IP	ZA-1 ZA-1P	ZA-1 ZA-1P	ZA-1 ZA-1P	ZA-1 ZA-1P
	SST-SX 125 SST-SX 250 SST-SX 350	-84 -84 -84	FEM-1D FEM-1I	ZA-1 ZA-1P			
	SXT 125	84-	SUZU-13P SUZU-4I SUZU-4IP				
	S.CITY 125	92-	ZA-4DP	ZA-4DP	ZA-4DP		
	TRIAL 125 TRIAL 350	- -		CL-2I CL-3I			
	W 12 350	94	ZA-1 ZA-1P	ZA-1 ZA-1P	ZA-1 ZA-1P	ZA-1 ZA-1P	ZA-1 ZA-1P
	W 16	97	ZA-1 ZA-1P	ZA-1 ZA-1P	ZA-1 ZA-1P		
CIMATTI	GRINGO G1-4M GRINGO LUX	- -		ZA-1 ZA-1P		FAB-1	
DEMM	SMILY	-		NE-6 NE-6P			
DERBY	ATLANTIS 100	2003	ZA-9P1	ZA-9P1	ZA-9P1	ZA-9P1	ZA-9P1
	PREDATOR	99		ZA-9P1		ZA-9P1	ZA-9P1
DKM-HERCULES	125 G SPEC. 175 GS 250 GS 505 P 531 535 S	- - - - - -		NE-6 NE-6P			
DUCATI	125 REG. 2T	-		NE-6 NE-6P			
	250 SCRAMBL. 350 GTV 350 SCRAMBL. 450 SCRAMBL. 500 2 CIL.	82- 82- 82- 82- 82-	FEM-1D FEM-1I FEM-2D FEM-2I	NE-6 NE-6P			







MARCA	MODELO						
	500 GTL 500 SL PANT. 750 GT-SS 750 SPORT 860 GT-GTS 900 2 CIL. 900 REPLICIA 900 SD-SS	82- 82- 82- 82- 82- 82- 82- 82-					
	350 F3 DESMO 350 GTL-XL 350 SL-TL 500 GTV-SL 500 SPORT D. 600 SL-TL 900 DARMAH	84- 84- 84- 84- 84- 84- 84-	FEM-1D FEM-1I FEM-2D FEM-2I	NE-8	ZA-1 ZA-1P	FAR-1D FAR-1I	
	350 SPORT 400 SPORT 600 MONSTER 600 S.SPORT 750 SS 851 S 851 SPORT 888 RACING 888 S.P.4 888 S.P.5 900 M 900 MONSTER 900 SS 900 S.L. 900 S.S. 907 i.e.	93- 93- 94-95 94 91-92 91-92 91-92 93- 91-92 93- 93- 94- 91- 91- 91-92 91-92	KAW-6P	KAW-6P	KAW-6P	KAW-6P	KAW-6P
	750 F1 DESMO	86-91	FEM-1D FEM-1I FEM-2D FEM-2I FI-6I FI-6IP3	NE-8	ZA-1 ZA-1P	FAR-1D FAR-1I	
	750 F1 DESMO 851 SPORT 907 i.e. DESMO 900 SS PASO 906	87- 89- 89- 89- 89-	ZA-13P	ZA-13P	ZA-13P	ZA-13P	ZA-13P
	750 INDIANA 750 SPORT R PASO 750 LTD	90-91 90-91 90-91	FI-6I FI-6IP3	FI-6I FI-6IP3	FI-6I FI-6IP3		FI-6I FI-6IP3
	851 S 900 S.S.	90-91 90-91	FI-6I FI-6IP3	ZA-1 ZA-1P	ZA-1 ZA-1P		ZA-1 ZA-1P
	907 i.e.	92	ZA-4DP	ZA-4DP	ZA-4DP	ZA-4DP	ZA-4DP
	CARENATA CUPOLINO	91- 91-	KAW-6P	KAW-6P			

MARCA	MODELO						
	INDIANA 350 INDIANA 650 INDIANA 750	87- 87- 87-		ZA-1 ZA-1P			
	PASO 350 PASO 750	87- 87-	ZA-13P	ZA-1 ZA-13P ZA-1P	ZA-13P	ZA-13P	ZA-13P
	ST 2	97	KAW-6P		KAW-6P	KAW-6P	
FANTIC MOTOR	50.1 OASIS CABALLERO CABALLERO 50 CLAN 50 CLUBMAN ISSIMO JOY 3V JOY MK JOY VK KOALA K-ROO RAIDER 50.1 RAILLY 240 TENTER TO TRIAL 50 TRIAL 201 TRIAL 240 TRIAL 241 TRIAL 242 TRIAL 245 TRIAL 300 TRIAL 301 TRIAL 303 TRIAL 305 TRIAL KID TRIAL S.5 TRIAL S.7	84-91 92- 84-91 82- 93- 82- 84-91 84-91 84-91 93- 92- 84-91 - 84-91 82- -91 -91 -91 -91 -91 -91 -91 -91 84-91 84-91 84-91		ZA-1 ZA-1P			
	125 125 SPORT ISSIMO 50 RAIDER 50 RAIDER GT 50 SPRINTER 3V SPRINTER 50 SPRINTER MU. STRADA 50	84- 84- 84- 84- 84- 84- 84- 84- 84-	ZA-1 ZA-1P	ZA-1 ZA-1P			
	ENDURO 50 RAIDER 125 TRIAL 50 TRIALMATIC50	85- - 85- 85-		NE-8			
	GR.TUR.50 CC	-		NE-6 NE-6P			
	HP1 125	-	FI-6I	FI-6I		ZA-1	







MARCA	MODELO						
			FI-6IP3	FI-6IP3		ZA-1P	
	LEI 50 CC	-		IMS-5 IMS-5P			
	RAIDER 125LC	-		ZA-1 ZA-1P		ZA-1 ZA-1P	
	STRADA 125	83-	ZA-1 ZA-1P	ZA-1 ZA-1P	ZA-1 ZA-1P	ZA-1 ZA-1P	ZA-1 ZA-1P
	TRIAL 125 TRIAL 200	- -		NE-8 ZA-1 ZA-1P			
GARELLI	BASIC 50 BASIC2 50 FORMUNO GARY GARY DUE 50 GARY UNO 50 SAHEL 50 ES TEAM 3V 50 TEAM BIMATIC TEAM MATIC URKA AC-LC50 VIP N3V 50	85- 85- 88-91 92- 88-91 88-91 -91 -91 -91 -91 -91 -91		ZA-1 ZA-1P			
	CICLONE 50 CICLONE 5V 5 EUREKA FLEX JUNIOR T 50 JUNIOR GT 50 JUNIOR K1005 NOI 50 VIP 1-N50 VIP 2-N50 VIP 3-N50 VIP 4-N50	-86 -86 - 82-86 82-86 -86 -86 - - - -		AF-19 AF-19P IMS-5 IMS-5P ZA-1 ZA-1P			
	CICLONE 5VN CICLONE LC NOI BIMATIC NOI MATIC NOI TL 50	86-88 86-88 87-91 87-91 87-91	ZA-1 ZA-1P	ZA-1 ZA-1P			
	GRAN TURISMO	-		NE-6 NE-6P			
	GTA 125	-	FI-6I FI-6IP3	FI-6I FI-6IP3	ZA-1 ZA-1P	ZA-1 ZA-1P	ZA-1 ZA-1P
	SUPER VIP TIGER 125XLE TRS 125 S.M. XR 125 TIGER	85-89 - - -	AF-6D	ZA-1 ZA-1P			
	TIGER XRD	-	ZA-1				







MARCA	MODELO						
			ZA-1P				
GILERA	50 GSA LUS 50 TS-GSA	- -	AF-6D	NE-8			
	50 R1 50 RALLY 50 RC TRO. 50 TREND	- - - -		ZA-2P			
	50 SIOUX A 125 APACHE 125 CROMO 125 FREE ST 125 GFR S.P 125 SIOUX 350 NORDWES 600 NORD WE 600 R 600 RC RC 750 R TYPHOON	- 91- 91- - - - 93- - 93- 91- - -95	ZA-4DP	ZA-4DP	ZA-4DP	ZA-4DP	
	125 CX AE 503 AE BULLIT AE BULLIT KICK BULLIT MIX SIOUX AE	- 93- 92 92 93- 93-	ZA-1 ZA-1P	ZA-1 ZA-1P			ZA-1 ZA-1P
	125 GR1-TG1 150 ECO 50	- - -		NE-6 NE-6P			
	125 GRF 125 R	93- 93-	ZA-1 ZA-1P	ZA-1 ZA-1P	ZA-1 ZA-1P		
	125 MRX 125 RC 125 SPO1 125 SPO2 125 XR2 R.	-91 -91 -91 -91 -91	FI-1 FI-1P	FI-1 FI-1P	FI-1 FI-1P	FI-1 FI-1P	
	125 TG2	-	AF-6D	ZA-1 ZA-1P		FAR-1D FAR-1I	
	200 T 4 200 T45 CUSTOM 125 CUSTOM 200	- - - -	AF-9D AF-9DP AF-9I AF-9IP FEM-1D FEM-1I				
	250 NGR	-	FI-6I FI-6IP3	FI-6I FI-6IP3 ZA-1 ZA-1P	ZA-1 ZA-1P	ZA-1 ZA-1P	







MARCA	MODELO						
	350 DAKOTA 500 DAKOTA	-90 -90	FI-6I FI-6IP3	FI-6I FI-6IP3	FI-6I FI-6IP3	ZA-1 ZA-1P	
	500 SATURNO 600 RC	-90 -90	ZA-2P	ZA-2P	ZA-2P	ZA-2P	
	ARIZONA 125 ARIZONA 250 RTX 125-200 RV 125-200 RX 125-200	- - - - -	ZA-1 ZA-1P	ZA-1 ZA-1P		ZA-1 ZA-1P	
	CBA 50	-91		ZA-1 ZA-1P			
	RC 600 R	91-	ZA-1 ZA-1P	ZA-1 ZA-1P	ZA-1 ZA-1P	ZA-1 ZA-1P	
	STORM 50	95	ZA-7DP		ZA-7DP		ZA-7DP
	TYPHOON	95-	ZA-7DP		ZA-7DP		
HARLEY DAVIDSON	FLH 1340 EL FLHC 1340 EL FLHC 1340 S. FLT 1340 TO. FLTC 1340 TO FXB 1340 ST. FXE 1340 SU. FXPS 1340 SU FXR 1340 SU. FXS 1340 LOW FXWG 1340 WI XLH 1000 SP XLS 1000 RO	- - - - - - - - - - - - -	HD-1 HD-1D HD-2 HD-2D HD-3 HD-3D	NE-6 NE-6P NE-8			
	VARIOS	-60	BS-6				
	VARIOS	96	CHI-1T	CHI-1T			
HERCULES	K 125	-	YAMA-21I YAMA-21IP				
HONDA	125 125 S	80- 80-	SUZU-13P SUZU-4I SUZU-4IP	NE-6 NE-6P			
	125 E 125 SILHO.	80-82 80-	SUZU-13P SUZU-4I SUZU-4IP	NE-6 NE-6P	SUZU-13P SUZU-4I SUZU-4IP	FAB-1	
	125 E	82-	SUZU-13P SUZU-4I SUZU-4IP	NE-8		FAR-1D	
	125 LEAD	91	HOND-4I HOND-4IP1	HOND-4I HOND-4IP1	HOND-4I HOND-4IP1		







MARCA	MODELO						
	125 VISION	-	SUZU-13DP SUZU-4D SUZU-4DP	SUZU-13DP SUZU-4D SUZU-4DP	SUZU-13DP SUZU-4D SUZU-4DP		
	200 R	-89	HOND-19 HOND-19D HOND-19DP HOND-19P HOND-4D HOND-4DP HOND-4DP2 HOND-4I HOND-4IP	HOND-19 HOND-19D HOND-19DP HOND-19P HOND-4D HOND-4DP HOND-4DP2 HOND-4I HOND-4IP	HOND-19 HOND-19D HOND-19DP HOND-19P HOND-4D HOND-4DP HOND-4DP2 HOND-4I HOND-4IP		HOND-19 HOND-19D HOND-19DP HOND-19P HOND-4D HOND-4DP HOND-4DP2 HOND-4I HOND-4IP
	350 FOUR 500 FOUR	79-81 79-	HOND-7I	NE-6 NE-6P	HOND-7I		
	350 FOUR	81-	HOND-4D HOND-4DP HOND-4DP2	NE-6 NE-6P	HOND-4D HOND-4DP HOND-4DP2	HOND-4D HOND-4DP HOND-4DP2	
	400 CBF 500 CBT	79- -	HOND-3I	NE-6 NE-6P			
	400 FOUR CB 400 N CB 750 K CM 400 T CX 500	81-82 81-82 80- 81-82 81-82	HOND-4D HOND-4DP HOND-4DP2	NE-6 NE-6P	HOND-4D HOND-4DP HOND-4DP2	HOND-4D HOND-4DP HOND-4DP2	HOND-4D HOND-4DP HOND-4DP2
	500 FOUR	76-79	HOND-21	NE-6 NE-6P	HOND-21		
	500 FOUR K CX 500	79- 79-81	HOND-4D HOND-4DP HOND-4DP2				
	500 R	83-	VO-VBP1	VO-VBP1	VO-VBP1		VO-VBP1
	500 R CROSS CB 250 N CB 250 RS CB 750 C CB 750 K CB 900 B. CB 900 F CB 900 FII CB 1100 R CBR 250 F CBX 400 F CBX 400 FC CBX 400 FII FT 500 RAVEL 250 REBEL 250 XL 500 R XL 500 S XR 500 R	82- 86- 86- 79- 79-80 82- 82- 82- - 86- 82- 84- 84- 83-84 86- 86- 82-84 82- 82-84	HOND-4D HOND-4DP HOND-4DP2	NE-8	HOND-4D HOND-4DP HOND-4DP2	HOND-4D HOND-4DP HOND-4DP2	HOND-4D HOND-4DP HOND-4DP2







MARCA	MODELO						
	600 PROA. 600 VTR. XL 600 XL 600 LM XL 600 R XL 600 RM XL 600 RX	85-91 85-91 85-91 85-91 85-91 85-91 85-91	HOND-4D HOND-4DP HOND-4DP2 HOND-4I HOND-4IP	HOND-4D HOND-4DP HOND-4DP2 HOND-4I HOND-4IP		HOND-4D HOND-4DP HOND-4DP2 HOND-4I HOND-4IP	HOND-4D HOND-4DP HOND-4DP2 HOND-4I HOND-4IP
	600 R	83-	VO-VBP1	VO-VBP1	VO-VBP1	VO-VBP1	VO-VBP1
	600 V T. CB 750 NTV 650 NX 650 D VFR 750 VT 600	92- 92- 92-96 83- 86- 89-	HOND-4D HOND-4DP1 HOND-4DP2	HOND-4D HOND-4DP1 HOND-4DP2	HOND-4D HOND-4DP1 HOND-4DP2	HOND-4D HOND-4DP1 HOND-4DP2	HOND-4D HOND-4DP1 HOND-4DP2
	600 VTR. CBR 600 F CBR 1000 VF 750 C VFR 750 FK VFR 750 FL VFR 750 P. VFR 750 R XRV 750 A.	90- 87- 91-92 90- 90-91 90-91 90-91 90-91 92-	HOND-4I HOND-4IP1	HOND-4I HOND-4IP1	HOND-4I HOND-4IP1	HOND-4I HOND-4IP1	HOND-4I HOND-4IP1
	650 G.W. ASPENCADE CB 250 N CB 250 RS CB 400 N CB 550 CBR 1000 CBX 1100 6C. CL 250 N CL 250 S CM 250 C CX 500 ENTERSTAT GL 500 G.WING 1.2 ST 1100 PE VT 500 X 400 R	83-91 -91 82-85 82-85 82- 82- -91 - 82-85 82-85 82-85 82-84 -91 82- -91 91- 83-84 86-	HOND-4D HOND-4DP HOND-4DP2	HOND-4D HOND-4DP HOND-4DP2	HOND-4D HOND-4DP HOND-4DP2	HOND-4D HOND-4DP HOND-4DP2	HOND-4D HOND-4DP HOND-4DP2
	750 AFRICA	91	HOND-19 HOND-19D HOND-19DP HOND-19P HOND-4D HOND-4DP1 HOND-4DP2	HOND-19 HOND-19D HOND-19DP HOND-19P HOND-4D HOND-4DP1 HOND-4DP2	HOND-19 HOND-19D HOND-19DP HOND-19P HOND-4D HOND-4DP1 HOND-4DP2	HOND-19 HOND-19D HOND-19DP HOND-19P HOND-4D HOND-4DP1 HOND-4DP2	HOND-19 HOND-19D HOND-19DP HOND-19P HOND-4D HOND-4DP1 HOND-4DP2
	750 FOUR	79-	HOND-4D HOND-4DP HOND-4DP2				

MARCA	MODELO						
			HOND-4I HOND-4IP				
	750 RXLV 750 XLV	85- 85-	HOND-4I HOND-4IP	HOND-4I HOND-4IP		HOND-4I HOND-4IP	HOND-4I HOND-4IP
	1100 GOLD W. CB 650 CB 750 FII CB 750 F	- - 81- 80-	HOND-4D HOND-4DP HOND-4DP2		HOND-4D HOND-4DP HOND-4DP2	HOND-4D HOND-4DP HOND-4DP2	HOND-4D HOND-4DP HOND-4DP2
	1200 G.W. GL 1200 GL 1500 GX 1200 DL	-91 -91 -91 -91	VO-VBP1	VO-VBP1	HOND-4D HOND-4DP HOND-4DP2 HOND-4I HOND-4IP	HOND-4D HOND-4DP HOND-4DP2 HOND-4I HOND-4IP	HOND-4D HOND-4DP HOND-4DP2 HOND-4I HOND-4IP
	BIG RED 125 NH 125 PEAD SPACY XL 125 XL 500 XR 500	86- 86- - 84-86 84- 84-	HOND-19 HOND-19D HOND-19DP HOND-19P	HOND-19 HOND-19D HOND-19DP HOND-19P			
	CAMINO S 50 CBX 900 FII	- -		NE-8			
	CB 125 S	79-	HOND-4D HOND-4DP HOND-4DP2 HOND-4I HOND-4IP	NE-6 NE-6P			
	CB 125 SI. XL 125	82- 82-83	HOND-4I HOND-4IP	NE-6 NE-6P NE-8	HOND-4D HOND-4DP HOND-4DP2	HOND-4D HOND-4DP HOND-4DP2	HOND-4D HOND-4DP HOND-4DP2
	CB 125 T MTX 125 R SPACY SCOOT.	86- 86- -	HOND-4I HOND-4IP	HOND-4I HOND-4IP			
	CB 125 T2	82-	SUZU-13P SUZU-4I SUZU-4IP	NE-6 NE-6P		FAR-1D	
	CB 125 X CBX 125 CS 125	82- 82-83 82-	HOND-4I HOND-4IP	NE-6 NE-6P		FAR-1D	
	CB 400 L XL 125 PD XL 125 PD XL 125 R XL 125 SD	85- 84-86 84-86 84-86 84-86	HOND-4D HOND-4DP HOND-4DP2	HOND-4D HOND-4DP HOND-4DP2			
	CB 400 N	79-81	HOND-4D HOND-4DP HOND-4DP2	NE-6 NE-6P	HOND-4D HOND-4DP HOND-4DP2		





MARCA	MODELO						
	CB 450 CBR 1000 CX 500 NTV 650 NX 650 ST 1100 VF 400 VFR 400 VFR 750 XL 600	86 -92 84-87 84-94 91-94 -92 86 86 91 84-	HOND-19 HOND-19D HOND-19DP HOND-19P	HOND-19 HOND-19D HOND-19DP HOND-19P	HOND-19 HOND-19D HOND-19DP HOND-19P	HOND-19 HOND-19D HOND-19DP HOND-19P	HOND-19 HOND-19D HOND-19DP HOND-19P
	CB 450 CBX 1000 S.S CX 500 NTV 650 ST 1100 VF 400 F VFR 400 R XL 600	86- - 84- 84-92 -91 86- 86- -84	HOND-4D HOND-4DP HOND-4DP2 HOND-4I HOND-4IP	HOND-4D HOND-4DP HOND-4DP2 HOND-4I HOND-4IP	HOND-4D HOND-4DP HOND-4DP2 HOND-4I HOND-4IP	HOND-4D HOND-4DP HOND-4DP2 HOND-4I HOND-4IP	HOND-4D HOND-4DP HOND-4DP2 HOND-4I HOND-4IP
	CB 500 CB 1000 CBR 900 RR CBR 1000	94 93- 94 92-	HOND-4D HOND-4DP1 HOND-4DP2 HOND-4I HOND-4IP1	HOND-4D HOND-4DP1 HOND-4DP2 HOND-4I HOND-4IP1	HOND-4D HOND-4DP1 HOND-4DP2 HOND-4I HOND-4IP1	HOND-4D HOND-4DP1 HOND-4DP2 HOND-4I HOND-4IP1	HOND-4D HOND-4DP1 HOND-4DP2 HOND-4I HOND-4IP1
	CB 500S CB 500 S CBR 900 RR CBR 900RR CBR 1000 F CBR 1000F NTV 650 NTV 650 NX 650 NX 650 SFX 50 SFX 50 SH 50 SH 50 SH 100 SH 100 SJ 100 BALI SJ 100 BALI ST 1100 ST 1100	97- 97 97 97- 97 97- 97- 97 97- 97 97 97- 97 97- 97 97- 97 97- 97 97- 97- 97	HOND-24P	HOND-24P	HOND-24P	HOND-24P	HOND-24P
	CB 550 F	79-82		NE-6 NE-6P			
	CB 650 CB 750 CB 900 CB 1100 CBX 500 CBX 550 CBX 650	84- 86-91 84- -91 84-87 84- 84-	HOND-19 HOND-19D HOND-19DP HOND-19P HOND-4D HOND-4DP HOND-4DP2	HOND-19 HOND-19D HOND-19DP HOND-19P HOND-4D HOND-4DP HOND-4DP2	HOND-19 HOND-19D HOND-19DP HOND-19P HOND-4D HOND-4DP HOND-4DP2	HOND-19 HOND-19D HOND-19DP HOND-19P HOND-4D HOND-4DP HOND-4DP2	HOND-19 HOND-19D HOND-19DP HOND-19P HOND-4D HOND-4DP HOND-4DP2

MARCA	MODELO						
	CBX 750 CR 500 CX 650 FT 500 GL 650 GL 1100 NS 400 VF 500 VF 750 VF 1000 VF 1100 VRF 750 VT 500 XLV 750 YT 1100	86-91 84-87 84- 84-87 84- -91 86- 84-87 86-91 -91 -91 86-91 84-87 86-91 -91	HOND-4I HOND-4IP	HOND-4I HOND-4IP	HOND-4I HOND-4IP	HOND-4I HOND-4IP	HOND-4I HOND-4IP
	CB 650 CUST CB 650 SC	- -	HOND-4D HOND-4DP1 HOND-4DP2	NE-8	HOND-4D HOND-4DP1 HOND-4DP2	HOND-4D HOND-4DP1 HOND-4DP2	HOND-4D HOND-4DP1 HOND-4DP2
	CB 750 F	79-	HOND-7D HOND-7I	NE-6 NE-6P	HOND-7D HOND-7I	HOND-7D HOND-7I	HOND-7D HOND-7I
	CB 750 FO.	78-	HOND-7I		HOND-7I		
	CBX 125 MH 125 XL 125	83-84 83- 83-	SUZU-13P SUZU-4I SUZU-4IP	NE-6 NE-6P NE-8		FAR-1D FAR-1I	
	CBX 125	84-	HOND-4D HOND-4DP HOND-4DP2	HOND-4D HOND-4DP HOND-4DP2	HOND-4D HOND-4DP HOND-4DP2	FAR-1D FAR-1I	HOND-4D HOND-4DP HOND-4DP2
	CBX 900	84-	HOND-19 HOND-19D HOND-19DP HOND-19P		HOND-19 HOND-19D HOND-19DP HOND-19P	HOND-19 HOND-19D HOND-19DP HOND-19P	HOND-19 HOND-19D HOND-19DP HOND-19P
	CDI 125 6	84-86	HOND-4D HOND-4DP HOND-4DP2	NE-8			
	CG 125 ECONO POW.90	93- 93-	HOND-26DP1 HOND-26P1	HOND-26DP1 HOND-26P1	HOND-26DP1 HOND-26P1	HOND-26DP1 HOND-26P1	HOND-26DP1 HOND-26P1
	CMX 450 SC.	-91	SUZU-13P SUZU-4I SUZU-4IP	SUZU-13P SUZU-4I SUZU-4IP	SUZU-13P SUZU-4I SUZU-4IP		
	CN 250 XL 250	91-94 -91	HOND-19 HOND-19D HOND-19DP HOND-19P	HOND-19 HOND-19D HOND-19DP HOND-19P			HOND-19 HOND-19D HOND-19DP HOND-19P
	CN 250 XL 250 R	-91 -91	HOND-4I HOND-4IP	HOND-4I HOND-4IP			HOND-4I HOND-4IP
	CR 250	-91	HOND-19	HOND-19			HOND-19







MARCA	MODELO						
			HOND-19D HOND-19DP HOND-19P HOND-4I HOND-4IP	HOND-19D HOND-19DP HOND-19P HOND-4I HOND-4IP			HOND-19D HOND-19DP HOND-19P HOND-4I HOND-4IP
	CRM 125 NSR 125 F NSR 125 R NSR 125 R SP	90 90- 90- 90-	HOND-4D HOND-4DP1 HOND-4DP2 HOND-4I HOND-4IP1	HOND-4D HOND-4DP1 HOND-4DP2 HOND-4I HOND-4IP1	HOND-4D HOND-4DP1 HOND-4DP2 HOND-4I HOND-4IP1		HOND-4D HOND-4DP1 HOND-4DP2 HOND-4I HOND-4IP1
	CRM 125 MTX 200 PK 50 DX WA. SA 50 M VIS. TRX 200 XL 125 XL 200	90-92 -89 92 92 -89 90- -91	HOND-19 HOND-19D HOND-19DP HOND-19P	HOND-19 HOND-19D HOND-19DP HOND-19P	HOND-19 HOND-19D HOND-19DP HOND-19P		HOND-19 HOND-19D HOND-19DP HOND-19P
	LEAD 100	2003	HOND-28P				
	MTX 125 MX 125	90-92 90-92	HOND-19 HOND-19D HOND-19DP HOND-19P HOND-4D HOND-4DP1 HOND-4DP2 HOND-4I HOND-4IP1	HOND-19 HOND-19D HOND-19DP HOND-19P HOND-4D HOND-4DP1 HOND-4DP2 HOND-4I HOND-4IP1	HOND-19 HOND-19D HOND-19DP HOND-19P HOND-4D HOND-4DP1 HOND-4DP2 HOND-4I HOND-4IP1		HOND-19 HOND-19D HOND-19DP HOND-19P HOND-4D HOND-4DP1 HOND-4DP2 HOND-4I HOND-4IP1
	MTX 200 R TRX 200 SX XL 200 XL 200 PD	-89 -89 -89 -89	HOND-4D HOND-4DP HOND-4DP2 HOND-4I HOND-4IP	HOND-4D HOND-4DP HOND-4DP2 HOND-4I HOND-4IP	HOND-4D HOND-4DP HOND-4DP2 HOND-4I HOND-4IP		HOND-4D HOND-4DP HOND-4DP2 HOND-4I HOND-4IP
	NH 50 PA 50 DLX PK 50 DX PX 50 S SA 50	-91 -91 -91 -91 -91	AF-6D	NE-8			
	NX 125	90-	HOND-4I HOND-4IP	HOND-4I HOND-4IP	HOND-4I HOND-4IP		HOND-4I HOND-4IP
	NXR 650 A. PC 800	88-90 89-91	HOND-4I HOND-4IP	HOND-4I HOND-4IP	HOND-4I HOND-4IP	HOND-4I HOND-4IP	HOND-4I HOND-4IP
	PHANTEON 150	2003	ZA-9P1	ZA-9P1	ZA-9P1	ZA-9P1	ZA-9P1
	PK 50 SA 50 P SH 50	93- 93- 93-96	HOND-25P2 HOND-4I HOND-4IP1	HOND-25P2 HOND-4I HOND-4IP1	HOND-25P2 HOND-4I HOND-4IP1		HOND-25P2 HOND-4I HOND-4IP1
	SFX 50 SJ 50 BALI	94-95 94-95	HOND-20 HOND-20D		HOND-20 HOND-20D		HOND-20 HOND-20D

MARCA	MODELO						
			HOND-20DP HOND-20P		HOND-20DP HOND-20P		HOND-20DP HOND-20P
	SH 50	91-93	VO-VBP1	HOND-30DP2 HOND-30P2 VO-VBP1	HOND-30DP2 HOND-30P2		HOND-30DP2 HOND-30P2 SUZU-13DP SUZU-4D SUZU-4DP
	VF 750 C VF 750 CU. VF 750 S	82-90 82- 82-	VO-VBP1	VO-VBP1	HOND-4D HOND-4DP HOND-4DP2	HOND-4D HOND-4DP HOND-4DP2	HOND-4D HOND-4DP HOND-4DP2
	VFR 750	89-91	HOND-20 HOND-20D HOND-20DP HOND-20P	HOND-20 HOND-20D HOND-20DP HOND-20P	HOND-20 HOND-20D HOND-20DP HOND-20P	HOND-20 HOND-20D HOND-20DP HOND-20P	HOND-20 HOND-20D HOND-20DP HOND-20P
	VRF 750	89-91	HOND-28DP HOND-28P	HOND-28DP HOND-28P	HOND-28DP HOND-28P	HOND-28DP HOND-28P	HOND-28DP HOND-28P
	XL 125 P3 XL 125 R3 XL 200 P3 XL 200 PD XL 200 R XL 200 R2	90- 90- 89-91 89-91 89-91 89-91	HOND-4D HOND-4DP HOND-4DP2	HOND-4D HOND-4DP HOND-4DP2	HOND-4D HOND-4DP HOND-4DP2		HOND-4D HOND-4DP HOND-4DP2
	XL 350 R XL 350 RF	86-91 86-91	VO-VBP1	VO-VBP1			
	XL 500 R XR 500 R	84- 84-	HOND-4D HOND-4DP HOND-4DP2 HOND-4I HOND-4IP	HOND-4D HOND-4DP HOND-4DP2 HOND-4I HOND-4IP			
ITALJET	ASCOT BAZOOKA TIFFANY	92- 92- 92-	YAMA-27 YAMA-27D YAMA-27DP YAMA-27P	YAMA-27 YAMA-27D YAMA-27DP YAMA-27P	YAMA-27 YAMA-27D YAMA-27DP YAMA-27P		YAMA-27 YAMA-27D YAMA-27DP YAMA-27P
	DRAGSTER	98	ZA-9P	ZA-9P	ZA-9P	ZA-9P	ZA-9P
	FORMULA 50	96-	ZA-4DP		ZA-4DP	ZA-4DP	
	PISTA SCOOP	94 94	YAMA-27DP YAMA-27P	YAMA-27DP YAMA-27P	YAMA-27DP YAMA-27P	YAMA-27DP YAMA-27P	YAMA-27DP YAMA-27P
KAWASAKI	400 CUSTOM 750 CUSTOM EN 500 KLX 650 TWIN CAM VN 1500 SUMO VN 1600 ZXR 400 ZXR 1100	91- 91- 93- - 92 - 2003 91- 91-	KAW-6P	KAW-6P	KAW-6P	KAW-6P	KAW-6P



MARCA	MODELO						
	TENGAI 650 VN 750 T. Z 250 Z 305 B. Z 400 Z 440 Z 550 Z 750 Z 1000 RZ Z 1100 Z 1300 ZN 1300 V ZR 550 ZX 550 ZX 1000 ZXR 750	80-91 84-91 84- 84- 84- 84- 84-90 85-92 84-91 84- 86-91 86-91 84-90 84-90 84-91 85-92					
	AR 125 KDX 175 KE 125 KE 175 KMX 125 KX 125	-86 - -86 - -86 -86		NE-6 NE-6P			
	EN 500	-91	KAW-2I	KAW-2I	KAW-2I	KAW-2I	KAW-2I
	ER 5 NINJA ZX- 6R NINJA ZX- 7R NINJA ZX- 9R NINJA ZX-12R ZR 7 ZZR 1200	2003 2003 2003 2003 2003 1999 2003	KAW-9P	KAW-9P	KAW-9P	KAW-9P	KAW-9P
	GLX 1100 GPX 600 GPZ 500 GPZ 500 S GPZ 600 KDX 250 D KL 250 KLE 500 KLR 250 KX 250 LTD 450 C. Z 650 ZL 600 ZZR 600	93- 86-90 87- 94 86-90 - 86- 94 86- 86- 86- 83 90-92 90-92	KAW-5 KAW-5P	KAW-5 KAW-5P	KAW-5 KAW-5P	KAW-5 KAW-5P	KAW-5 KAW-5P
	GPZ 400 GPZ 550 LTD 450 Z 400 Z 400 TW. Z 440 LTD Z 550 LTD	- - - - - - -	KAW-3 KAW-4 SUZU-13P SUZU-4I SUZU-4IP	KAW-3 KAW-4	KAW-3 KAW-4	KAW-3 KAW-4	KAW-3
	GPZ 750	-84	KAW-3		KAW-3	KAW-3	KAW-3







MARCA	MODELO						
	Z 400 F Z 400 J Z 750	81-82 81-82 84-85					
	KH 400 OH 400 Z 400	78- 78- 78-81	KAW-4 SUZU-13DP SUZU-13P SUZU-4D SUZU-4DP SUZU-4I SUZU-4IP			SUZU-13DP SUZU-13P SUZU-4D SUZU-4DP SUZU-4I SUZU-4IP	
	KL 600 S KLR 600	86-91 86-91	KAW-2D KAW-2I	KAW-2D KAW-2I	KAW-2D KAW-2I	KAW-2D KAW-2I	KAW-2D KAW-2I
	KLR 250	85-86	KAW-2I	KAW-2I			
	KLR 600 Z 440 Z 650 F Z 650 S Z 650 SR	- - 84-91 84-91 84-91	KAW-1D KAW-1I	KAW-1D KAW-1I	KAW-1D KAW-1I	KAW-1D KAW-1I	KAW-1D KAW-1I
	KLR 600 S KLR 650 NINJA ZX- 9R ZXR 750 ZZR 600 ZZR 1100	94-95 94-95 94-95 93-94 94-95 93-94	KAW-7P	KAW-7P	KAW-7P	KAW-7P	KAW-7P
	LDT 500 VN 800	95 95	KAW-6DP	KAW-6DP	KAW-6DP	KAW-6DP	KAW-6DP
	SJ 50 BALI	94	KAW-5 KAW-5P	KAW-5 KAW-5P	KAW-5 KAW-5P		KAW-5 KAW-5P
	Z 250 A Z 250 C Z 250 J	82- 82- 82-	KAW-2I KAW-8 KAW-8D		KAW-2I KAW-8 KAW-8D	KAW-2I	
	Z 400 Z 400	78-80 81-	KAW-8		KAW-8		
	Z 400	81-84	KAW-2I		KAW-2I		
	Z 440 H Z 440 J Z 440 LTD	82- 82- 82-	KAW-2D KAW-2I		KAW-2D KAW-2I	KAW-2D KAW-2I	KAW-2D KAW-2I
	Z 500	81-	KAW-3		KAW-3	KAW-3	
	ZL 600 ELI.	97	KAW-5 KAW-5P		KAW-5 KAW-5P	KAW-5 KAW-5P	
	ZXR 400 ZXR 1100 ZZR 1100	90-91 90-91 90-91	KAW-2D	KAW-2D	KAW-2D	KAW-2D	KAW-2D
KTM	ER 5	2003	ZA-9P1	ZA-9P1	ZA-9P1		

MARCA	MODELO							
	MODELOS	88-	VO-VBP1	VO-VBP1	VO-VBP1	VO-VBP1	VO-VBP1	
KYMCO	CX 50 K 1250 KB 50 SNIPER 50 DD	97 97 97 97	HOND-4I HOND-4IP	HOND-4I HOND-4IP	HOND-4I HOND-4IP			
	HEROISM	97-	KYM-1DP KYM-1P	KYM-1DP KYM-1P	KYM-1DP KYM-1P	KYM-1DP KYM-1P	KYM-1DP KYM-1P	
LAMBRETTA	LUI 50	-		IMS-3 IMS-3P NE-56				
LAVERDA	50 ATLAS 50 GAUCHO 125 CU RIDE 125 FORMULA 125 LESMO G 600 ATLAS O 1000 SFC	86-90 86- 86-90 86-90 86-90 - 86-	ZA-1 ZA-1P	ZA-1 ZA-1P				
	50 LZ	-	NE-8	NE-8				
	125 GS LES. 125 L ELEG. 125 LB CUS. 125 LB SAB. 125 LB UNO 125 LZ CUS. 350 LESMO V6 1000 R	84- 84- 84- 84- 84- 84- 84- -	ZA-1 ZA-1P	ZA-1 ZA-1P	ZA-1 ZA-1P	ZA-1 ZA-1P	ZA-1 ZA-1P	
	125 LZ 125 LZ C. 125 LZ S.	78- 78- 78-	NE-6 NE-6P NE-8	NE-6 NE-6P	NE-8	FAR-1D FAR-1I		
	500 4T 500 SFC 1000 JOTA 1000 JOTA120 1000 RGS 1200 TS	- - - - - 78-	SUZU-13P SUZU-4I SUZU-4IP	NE-6 NE-6P		FAR-1D FAR-1I		
	750 1000 1200	78- 78- 78-	SUZU-13P SUZU-4I SUZU-4IP	NE-6 NE-6P				
	PHOENIX	2003	ZA-8P	ZA-8P	ZA-8P	ZA-8P	ZA-8P	
	LINCE	125 SERVETTE 150 SERVETTE 200 SERVETTE	- - -		CL-2I CL-3I	AF-5D		
	MAICO	GM STAR 250E GM STAR 500E GM STAR SID.	- - -		CL-2I CL-3I NE-6			







MARCA	MODELO							
				NE-6P NE-8				
MALAGUTI	50 MDX	86-91	ZA-1	ZA-1				
	50 MEX	86-91	ZA-1P	ZA-1P				
	50 MFX	86-91						
	50 MGX	86-91						
	CUSTOM	86-91						
	FIFTY FULL	86-						
	FIFTY HF 50	86-91						
	FIFTY TOP 50	86-						
	RUNNER YLC	86-91						
	TOP 50	86-91						
MALAGUTI	125	86-		ZA-1				
	125 RUNNER	86-		ZA-1P				
	CAVALCONE 80	-						
	CHOPPER 25	-						
	CHOPPER 40	-						
	CHOPPER 80	-						
	DRIBBLING	86-						
	DROP	-						
	DUNE ES	86-						
	DUNE KS	86-						
	FIFTY	-						
	FIRE BIRD	-						
	GRIZLY UNO	-						
MRX ENDURO	86-							
NEW DRIBBLING	-							
PULL CX	-							
MALAGUTI	CENTRO SL	94	ZA-4DP	ZA-4DP				
	CROSSER 50	94-						
	F 10	94						
	PHANTOM	94						
MALAGUTI	F 10 JET	92-	YAMA-27 YAMA-27D YAMA-27DP YAMA-27P YAMA-30P	YAMA-27 YAMA-27D YAMA-27DP YAMA-27P YAMA-30P				
	FIREFOX F15	96-97	ZA-9P	ZA-9P	ZA-9P		ZA-9P	
	MADISON	2003	ZA-9P	ZA-9P	ZA-9P	ZA-9P	ZA-9P	
	RS	91	ZA-4DP	ZA-4DP		ZA-4DP		
	RST 50	91-92	ZA-13P ZA-4DP	ZA-4DP	ZA-13P	ZA-4DP	ZA-13P	
	MALANCA	125 MARKT	-	ZA-1 ZA-1P	ZA-1 ZA-1P			
		BIG GTS 4 4M GTS 5 LP	- - - -		ZA-1 ZA-1P			









MARCA	MODELO						
	V 65 LA. V 65 SP V 65 TT V 75	84- 84- 84- 84-					
	125 BX 125 CUSTOM 125 TT	86- 86- 86-		NE-8			
	125 TURISMO V 35 V 35 C V 35 F V 35 II V 35 III V 35 IMOLA	81- 84- 84-86 84- 84- 84- 84-	IMS-5 IMS-5P	NE-8		IMS-5 IMS-5P	
	125 TURISMO DINGO STORNELLO	- - -		NE-6 NE-6P			
	250 ELECTR.	-	FEM-2D FEM-2I	NE-8			
	250 TS	-	FEM-2D FEM-2I	NE-6 NE-6P			
	254	-	IMS-5 IMS-5P	NE-8			
	350 500	79- -	IMS-5 IMS-5P	NE-6 NE-6P			
	350 GTS	-	FEM-2D FEM-2I	NE-6 NE-6P	FEM-2D FEM-2I		
	350 NEVADA 750 NEVADA	94 94-	ZA-1 ZA-1P	ZA-1 ZA-1P			
	750 850 LE MANS 850 T3 850 T3 C.	79- 79-81 79-86 79-81	FEM-1D FEM-1I SIP-3	NE-6 NE-6P		IMS-5 IMS-5P	
	750 NTX V 75 NTX	90- 90-	ZA-1 ZA-1P	NE-8	ZA-1 ZA-1P	ZA-1 ZA-1P	ZA-1 ZA-1P
	850 GT	86-	FEM-1D FEM-1I	NE-6 NE-6P		FAB-1	
	850 LE MANS 850 T3 C. 850 T3-T4 V 35 V 35 II V 35 IMOLA V 50 C V 50 CH.	81- 81- 81- 82-84 82-84 82-84 82-84 82-	IMS-5 IMS-5P	NE-6 NE-6P NE-8		IMS-5 IMS-5P	







MARCA	MODELO						
	V 50 III V 50 MONZA V 50 TS V 65 V 75	82-90 82-84 82- - -					
	850 T3	86-		NE-6 NE-6P	ZA-1 ZA-1P	ZA-1 ZA-1P	ZA-1 ZA-1P
	850 T5	86-	IMS-5 IMS-5P	NE-6 NE-6P	ZA-1 ZA-1P	ZA-1 ZA-1P	ZA-1 ZA-1P
	1000 GT RL 1000 GT RR 1000 LE MANS 1000 S 1000 ST II 1000 ST III V 35 C V 35 GT V 35 NTX V 35 TT	90- 90- 90- 90- - - 86- 86- 86- 86-	IMS-5 IMS-5P	ZA-1 ZA-1P	ZA-1 ZA-1P	ZA-1 ZA-1P	ZA-1 ZA-1P
	BREVA CALIFOR. EV V 11	2003 2003 2003	ZA-9P1	ZA-9P1		ZA-9P1	
	FAL.SAHARA	-	FEM-1D				
	SP 1000 II V 1000 CALI. V 1000 CONV. V 1000 GT V 1000 SP V 1000 SP II	84- 84- 84- 84- 84- 84-	IMS-5 IMS-5P	NE-6 NE-6P		IMS-5 IMS-5P	
	V 7 SPORT	-	SIP-3	NE-6 NE-6P			
	V 1000 C.	79-	FEM-1D FEM-1I SIP-3	NE-6 NE-6P			
	V 1000 G5	79-	IMS-5 IMS-5P	IMS-5 IMS-5P		IMS-5 IMS-5P	
	V 1000 I LE. V 1000 IDRO. V 1000 II L.	84- 84- 84-	IMS-5 IMS-5P	NE-8		IMS-5 IMS-5P	ZA-1 ZA-1P
MOTO MORINI	3 1/2 SPO. 3 1/2 V 125 T 250 250 BIC 500 GV 500 KANGEROO 500 T/S	81- 81- 81- 81- 81- - - -	FEM-1D FEM-1I	NE-6 NE-6P			







MARCA	MODELO						
	50 CORSARIO 125 CORSARIO 250 KANGURO 250 STRADA 550	- - 79- 79- 79-		NE-6 NE-6P			
	125 H 125 KJ	84- 84-	FEM-2D FEM-2I	ZA-1 ZA-1P			
	350 COGUARO 350 EXCALIB. 350 KANGURO 350 NEW YORK 350 XE 501 COGUARO 501 EXCALIB. 501 KANGURO 501 NEW YORK	86- 86- 86- 86- 86- 86- 86- 86- 86-	AF-6D	ZA-1 ZA-1P	ZA-1 ZA-1P	ZA-1 ZA-1P	ZA-1 ZA-1P
	500 CAMEL	-	AF-6D	NE-8			
MOTOBECANE	125 LT SUPERMOBY 51	- -	LAS-X	NE-6 NE-6P			
MOTOBI	254	-	IMS-5 IMS-5P	NE-8			
MOTRON	3/TRE-RCV MST RA PL 4P SU 3R 1D TAXI AP TAXI ES 1D	- - - - - -		ZA-1 ZA-1P			
	COMPACT GL 4 GTO INVADER SHOPPING TAXI ES ID TAXI KS SL	90-91 90-91 90-91 90-91 90-91 90-91 90-91	ZA-1 ZA-1P	ZA-1 ZA-1P			
MV AUGUSTA	125 S	-	FEM-1I		FEM-2I		
	125 SPORT 350 SPORT	- -		FEM-1I FEM-2I			
	350 S	-	AF-7I AF-7IP	AF-7I AF-7IP			
	750 S	-	SUZU-13P SUZU-4I SUZU-4IP	NE-6 NE-6P		FAR-1D FAR-1I	
MZ	TOUR	94	ZA-4DP			ZA-4DP	ZA-4DP
NORTON	850 COMMANDO	-	UN-3			UN-FS	

MARCA	MODELO						
OMC	CITY ELITE ELITE SL ELS-SL EXCLAIM HI TECH MARINER-SL MUDDY MUDDY JUNIOR WILD ELITE WILD MS WILD TIGRE	- - - - - - - - - - - -		ZA-1 ZA-1P			
OSSA	125 250 ENDURO 350 ENDURO	- - -	CAS-1D	NE-6 NE-6P			
	250 DESERT 250 EXPLORER 250 FUEGO 250 ORANGE 250 SUPER 250 TRIAL 250 TU 250 TURISMO 250 YO 350 EXPLORER 350 ORANGE 350 TRIAL TRIAL 303 TRIAL JELLOW	- - - - - - - - - - - - - -			CL-2I CL-3I		
PERIPOLI	COLORADO DAY LXR/SA DAY S 5/K GIULIETTA MINI L SAM1K OXFORD OXFORD ROAD TIR VAI MO3 VAI R WILD	- - - - - - - - - - -		ZA-1 ZA-1P			
PEUGEOT	BUXY FOR LUX SPEEDAKE SQUAB	95- 94 95- 95-96	ZA-1	ZA-1			
	SC 50 L SCO. SC 80 L SCO. ST 50 L SCO. SV 125 SCO.	- - - -	SUZU-13P SUZU-4I SUZU-4IP	SUZU-13P SUZU-4I SUZU-4IP			
	SQUAB	97	NE-45P		NE-45P		
	SV 50 GEO	92-	NE-45	NE-45	NE-45		NE-45







MARCA	MODELO						
	SV 80 GEO SV 125 GEO	93- 93-	NE-45P	NE-45P	NE-45P		NE-45P
PGO	SCOOTER	-	PGO-1				
PIAGGIO	APE 600 MP	79-81		AF-6D			
	APE CAR APE CAR P3 APE CARP 601	- - -	AF-9D AF-9DP AF-9I AF-9IP FEM-1D FEM-1I	FAB-1			
	APE P 50 APE TM P 50	- -	FEM-1D FEM-1I	NE-6 NE-6P		ZA-1 ZA-1P	
	APE TM 703	-	AF-9D AF-9DP AF-9I AF-9IP	FAB-1			
	BOSS 50 BRAVO 50 CIAO 50 GRILLO 50 SI 50	86- 86- 86- 86- 86-		ZA-1 ZA-1P	ZA-2P	ZA-2P	ZA-2P
	BOXER 50 BRAVO 50 CIAO 50 SI 50	82-86 82-86 82-86 82-86		NE-8 ZA-1 ZA-1P	FI-1 FI-1P	FI-1 FI-1P	FI-1 FI-1P
	BRAVO	92-		ZA-1 ZA-1P	ZA-1 ZA-1P		
	CIAO GRILLO SI	92- 92- 92-		ZA-1 ZA-1P			
	COSA 125 COSA 150 COSA 200 VESPA 50 PK VESPA FL 2 VESPA PLURI. VESPA RUSH	88- 88- 88- 86- 86- 86- 86-	ZA-2P	ZA-2P	ZA-2P	ZA-2P	ZA-2P
	COSA 125 MA COSA 150 MA COSA 2 125 COSA 2 150 COSA 2 200 COSA 200 MA VESPA 125 E VESPA P 125 VESPA PX 125 VESPA PX 150	92- 92- 93- 93- 93- 92- 84- 84-91 84-91 84-91	FI-1 FI-1P ZA-2P	FI-1 FI-1P ZA-2P	FI-1 FI-1P ZA-2P	FI-1 FI-1P ZA-2P	FI-1 FI-1P ZA-2P

MARCA	MODELO						
	VESPA PX 200	84-					
	FREE RL	95	ZA-7DP		ZA-7DP		ZA-7DP
	HEXAGON 125	96-	ZA-4DP	ZA-4DP	ZA-4DP		
	NICA 125	-	AF-9D AF-9DP AF-9I AF-9IP	FAB-1		ZA-2P	
	QUARTZ SFERA VESPA 50 ZIP	92- 92- 92- 92-	ZA-2P ZA-7DP	ZA-2P ZA-7DP	ZA-2P ZA-7DP		ZA-2P ZA-7DP
	SCATTO	-91	ZA-13P	ZA-13P			
	TOLEDO-SC	-		CL-2I CL-3I			
	VESPA 50 VESPA 50 ES	79-83 81-83	FEM-1D FEM-1I	NE-6 NE-6P	AF-5D	ZA-1 ZA-1P	NE-6 NE-6P
	VESPA 125 E VESPA P 125X VESPA P 150X VESPA P 200X VESPA PX125E	81-84 81- 81- 81- 81-		NE-6 NE-6P	AF-5D NE-6 NE-6P	AF-5D	NE-6 NE-6P
	VESPA 125 ET VESPA 200 PX VESPA P 150X	79- 79- 79-81	FEM-1D FEM-1I	ZA-1 ZA-1P	AF-5D ZA-1 ZA-1P	ZA-1 ZA-1P	NE-6 NE-6P
	VESPA 125ET3	-79	FEM-1I	NE-6 NE-6P	ZA-1 ZA-1P		NE-6 NE-6P
	VESPA 150 VESPA 150 RA VESPA 150 SV	79- 79- 79-		NE-6 NE-6P	AF-5D NE-6 NE-6P	NE-6 NE-6P	AF-5D
	VESPA P 80X	-		NE-6 NE-6P			
	VESPA P 125 VESPA PK 125	- -	FI-1 FI-1P ZA-2P	FI-1 FI-1P ZA-2P	FI-1 FI-1P ZA-2P		FI-1 FI-1P ZA-2P
	VESPA PK 50 VESPA PK 50S	84-86 84-86	FI-1 FI-1P	FI-1 FI-1P	FI-1 FI-1P	FI-1 FI-1P	FI-1 FI-1P
	VESPA PX 200	86-		NE-6 NE-6P	NE-6 NE-6P	NE-6 NE-6P	NE-6 NE-6P
RALEIGH	CICLI CYCLES	- -		LF-2 UN-FP			
RIZZATO	ATALA	95	ZA-4DP		ZA-4DP		ZA-4DP

MARCA	MODELO						
	HACKET AT12 HACKET RACL.	95 95					
SULKI	50 125	-92 92-	BH-4	BH-4	ZA-1 ZA-1P		
SUZUKI	400 ENDURO 400 S GT 350	78- 78- 78-	SUZU-13P SUZU-4I SUZU-4IP				
	650 DJEBEL DR 125 S DR 400 DR 600 RCT 125 TS 125 S TS 125 X	-91 - 80-85 85- - - -	SUZU-13P SUZU-4I SUZU-4IP	SUZU-13P SUZU-4I SUZU-4IP			
	ADDRESS DR 350 SE	92- 94	SUZU-11D SUZU-11DP	SUZU-11D SUZU-11DP			
	ADDRESS 100 DR 650 GS 400 GS 500 GS 750 GSF 400 GSF 500 EP GSF 600 GSX 600 GSX 750 GSX 1100 92 GSXR 750 GSXR 1100 RF 600 R RF 900 R RC 125 RS 650 VS 750 VS 800 VS 1400 VX 800	94 92- 93- 89- 91- 93- 93- 95 89- 89- 92- 89-96 90- 93- 94- 95 91 89- 92- 90- 90-	SUZU-11D SUZU-11DP	SUZU-11D SUZU-11DP	SUZU-11D SUZU-11DP	SUZU-11D SUZU-11DP	SUZU-11D SUZU-11DP
	AH 50 CP 50	91- 91-	YAMA-20I YAMA-24IP YAMA-28P	YAMA-20I YAMA-24IP YAMA-28P			
	AJ 50 ZZ AP 50	95 95	ZA-4DP	ZA-4DP	ZA-4DP		
	AN 125 VS 600 GL VS 800 GL	95 95 95	YAMA-23DP YAMA-23IP	NE-8		YAMA-23DP YAMA-23IP	YAMA-23DP YAMA-23IP
	CC 1 RV 90	- -	SUZU-13P SUZU-4I SUZU-4IP	NE-8			

MARCA	MODELO						
	DL 1000 GSXR 1000 SV 650 S SV 1000 S	2003 2003 2003 2003	SUZU-12DP	SUZU-12DP		SUZU-12DP	
	DR 125 SE LS 650 VS 1400 GLP	95 95 95	YAMA-20D YAMA-20I YAMA-20IP	NE-8		YAMA-20D YAMA-20I YAMA-20IP	YAMA-20D YAMA-20I YAMA-20IP
	DR 250 S DR 500 DR 650 DR 750 BIG DR 800 SL GS 125 ES GS 550 GS 850	84- 84-86 90-91 88-91 90- 84- 84-85 80-82	SUZU-13P SUZU-4I SUZU-4IP	SUZU-13P SUZU-4I SUZU-4IP	SUZU-13P SUZU-4I SUZU-4IP	SUZU-13P SUZU-4I SUZU-4IP	SUZU-13P SUZU-4I SUZU-4IP
	DR 350	97	YAMA-20I		YAMA-20I	YAMA-20I	YAMA-20I
	DR 350 S DR 350 SM DR 350 SN VS 750 J.	93- 92- 92- -	YAMA-20D YAMA-20I YAMA-24DP YAMA-24IP YAMA-28P	NE-8	YAMA-20D YAMA-20I YAMA-24DP YAMA-24IP YAMA-28P	YAMA-20D YAMA-20I YAMA-24DP YAMA-24IP YAMA-28P	YAMA-20D YAMA-20I YAMA-24DP YAMA-24IP YAMA-28P
	DR 650 RSE GS 500 E GSF 600 GSXR 750 SP GSXR 750 W GSXR 1100	95- 95- 95- 95- 95- 95-	SUZU-12DP	SUZU-12DP	SUZU-12DP	SUZU-12DP	SUZU-12DP
	G 450 L GN 400 GNX 250 GR 650 GS 450 GS 500 GS 550 GS 750 GS 850 GSX 250 S GSX 400 GSX 500 GSX 550 GSXR 1100 LS 650 LT 250 A RG 250 R RGV 250	80- 85- 85-91 82- 80- 84-89 82-84 82-87 82-85 85-91 85- 89- 85- 81- 82- 85-91 85-91 85-91	SUZU-5 SUZU-5P	SUZU-5 SUZU-5P	SUZU-5 SUZU-5P	SUZU-5 SUZU-5P	SUZU-5 SUZU-5P
	GS 400 T GT 500	- 78-	SUZU-13P SUZU-4I SUZU-4IP		SUZU-13P SUZU-4I SUZU-4IP	SUZU-13P SUZU-4I SUZU-4IP	SUZU-13P SUZU-4I SUZU-4IP
	GS 1000 GSX 1100	82-85 81-85	SUZU-13P SUZU-4I	SUZU-13P SUZU-4I	SUZU-13P SUZU-4I	SUZU-13P SUZU-4I	SUZU-13P SUZU-4I







MARCA	MODELO						
	RG 500	85-	SUZU-4IP SUZU-5 SUZU-5P	SUZU-4IP SUZU-5 SUZU-5P	SUZU-4IP SUZU-5 SUZU-5P	SUZU-4IP SUZU-5 SUZU-5P	SUZU-4IP SUZU-5 SUZU-5P
	GSX 750	81-89	SUZU-13P SUZU-4I SUZU-4IP SUZU-5 SUZU-5P	NE-8 SUZU-13P SUZU-4I SUZU-4IP SUZU-5 SUZU-5P	SUZU-13P SUZU-4I SUZU-4IP SUZU-5 SUZU-5P	SUZU-13P SUZU-4I SUZU-4IP SUZU-5 SUZU-5P	SUZU-13P SUZU-4I SUZU-4IP SUZU-5 SUZU-5P
	GSXR 600 GSXR 750	97 97	SUZU-12DP		SUZU-12DP	SUZU-12DP	SUZU-12DP
	GT 550 GT 750	78- 78-	SUZU-3I				
	INTRUDE.1400 VS 800 GL	93- 93-95	YAMA-19D YAMA-19DP YAMA-19I YAMA-19IP YAMA-23DP YAMA-23IP YAMA-29P	NE-8	YAMA-19D YAMA-19DP YAMA-19I YAMA-19IP YAMA-23DP YAMA-23IP YAMA-29P	YAMA-19D YAMA-19DP YAMA-19I YAMA-19IP YAMA-23DP YAMA-23IP YAMA-29P	YAMA-19D YAMA-19DP YAMA-19I YAMA-19IP YAMA-23DP YAMA-23IP YAMA-29P
	KATANA	97	ZA-4DP		ZA-4DP		
	VS 750 INT.	86-	YAMA-18D YAMA-18DP YAMA-18I YAMA-18IP YAMA-19D YAMA-19DP YAMA-19I YAMA-19IP YAMA-20D YAMA-20I YAMA-20IP YAMA-22DP YAMA-22IP YAMA-23DP YAMA-23IP YAMA-24DP YAMA-24IP YAMA-28P YAMA-29P	YAMA-18D YAMA-18DP YAMA-18I YAMA-18IP YAMA-19D YAMA-19DP YAMA-19I YAMA-19IP YAMA-20D YAMA-20I YAMA-20IP YAMA-22DP YAMA-22IP YAMA-23DP YAMA-23IP YAMA-24DP YAMA-24IP YAMA-28P YAMA-29P	YAMA-18D YAMA-18DP YAMA-18I YAMA-18IP YAMA-19D YAMA-19DP YAMA-19I YAMA-19IP YAMA-20D YAMA-20I YAMA-20IP YAMA-22DP YAMA-22IP YAMA-23DP YAMA-23IP YAMA-24DP YAMA-24IP YAMA-28P YAMA-29P	YAMA-18D YAMA-18DP YAMA-18I YAMA-18IP YAMA-19D YAMA-19DP YAMA-19I YAMA-19IP YAMA-20D YAMA-20I YAMA-20IP YAMA-22DP YAMA-22IP YAMA-23DP YAMA-23IP YAMA-24DP YAMA-24IP YAMA-28P YAMA-29P	YAMA-18D YAMA-18DP YAMA-18I YAMA-18IP YAMA-19D YAMA-19DP YAMA-19I YAMA-19IP YAMA-20D YAMA-20I YAMA-20IP YAMA-22DP YAMA-22IP YAMA-23DP YAMA-23IP YAMA-24DP YAMA-24IP YAMA-28P YAMA-29P
SWM	124 RZ 280 GS EXPLORER 125 EXPLORER 350 GS 125 GT 125 GTS 125 RS 125 RS 250 TL 329	- - - - - - - - - -	AF-6D	NE-6 NE-6P		FAR-1D FAR-1I	







MARCA	MODELO						
	350 XN	-	ZA-1 ZA-1P	ZA-1 ZA-1P			
	WPM 1	-		NE-6 NE-6P			
TESTI	CRICHERT PULL	-		NE-6 NE-6P			
TRIUMPH	TRIDENT	-	UN-3	NE-6 NE-6P		UN-FS	UN-FS
YAMAHA	250 COMPETI.	-	YAMA-3I	YAMA-3I			
	400 RD 400	- -	YAMA-14I YAMA-15D YAMA-15I	YAMA-14I YAMA-15D YAMA-15I	YAMA-14D		
	400 BICILIN.	-	YAMA-17D YAMA-17I	YAMA-17D YAMA-17I	YAMA-17D YAMA-17I	YAMA-17D YAMA-17I	YAMA-17D YAMA-17I
	500	79-	YAMA-9I	YAMA-9I			
	500 ENDURO RD 500 TT 350	79- 79- 95	YAMA-14I	YAMA-14I			
	600 ACERBIS OHC 650	80- 80-	YAMA-14D YAMA-14I	YAMA-14D YAMA-14I	YAMA-14D YAMA-14I	YAMA-14D YAMA-14I	YAMA-14D YAMA-14I
	AEROX NEOS VERSITY 300	98 98 2003	ZA-9P1	ZA-9P1	ZA-9P1	ZA-9P1	ZA-9P1
	AXIS BREEZE SPY	95- 95- 95-	ZA-4DP	ZA-4DP			
	BL 125 BE. DT 125 BA. DT 125 BB. DT 125 CF. DT 125 R RD 350 RT 125 LL SCROW 225 SR 250 TDR 125 TDR 250 TZR 125 TZR 250 XS 350 XT 600 XT 600 4V. XT 600 TE. XT 600 Z-ZA YZ 125 LC YZ 250 LC	84-91 84-91 84-91 84-91 84-86 84-91	YAMA-18D YAMA-18DP YAMA-18I YAMA-18IP YAMA-19D YAMA-19DP YAMA-19I YAMA-19IP YAMA-20D YAMA-20I YAMA-20IP YAMA-22DP YAMA-22IP YAMA-23DP YAMA-23IP YAMA-24DP YAMA-24IP YAMA-28P YAMA-29P	NE-8	YAMA-21I YAMA-21IP	YAMA-21I YAMA-21IP	YAMA-21I YAMA-21IP

MARCA	MODELO						
	BL 125 BE. DT 125 BA. DT 125 BB. DT 125 CF. DT 125 R RD 350 RD 350 LC RT 125 LL. SCROW 225 SR 250 TDR 125 TDR 250 TT 350 TZR 125 R TZR 250 XT 600 XT 600 4V. XT 600 TE. XT 600 Z-ZA YZ 125 LC YZ 250 LC	91- 91- 91- 91- 91-92 91- 91- 91- 91- 91- 91-92 91- 91-95 91-92 91- 91- 91- 91- 91- 91- 91-	YAMA-18D YAMA-18DP YAMA-18I YAMA-18IP YAMA-19D YAMA-19DP YAMA-19I YAMA-19IP YAMA-20D YAMA-20I YAMA-20IP	NE-8	YAMA-21I YAMA-21IP	YAMA-21I YAMA-21IP	YAMA-21I YAMA-21IP
	BREEZE	94	ZA-4DP	ZA-4DP	ZA-4DP	ZA-4DP	ZA-4DP
	BT 1100 BU.	2003	ZA-9P1	ZA-9P1		ZA-9P1	
	CR 50 Z CT 50 S SCOOTER MBK	92- 92- 91-	YAMA-27 YAMA-27P	YAMA-27 YAMA-27P	YAMA-27 YAMA-27P		
	CT 50 SS	95	YAMA-27DP YAMA-27P	YAMA-27DP YAMA-27P			
	DT 125 DT 125 LC.	-85 -85	YAMA-3D YAMA-3I	YAMA-3D YAMA-3I			
	DT 125 DT 125 B DT 125 R DT 125 Z TT 600 TT 600 S TZR 125 R TZR 125 RSP XT 600 A XT 600 E XT 600 ZA	92- 92- 92- 92- 93 91- 92- 92- 93- 91- 91-92	YAMA-18D YAMA-18I YAMA-19D YAMA-19I YAMA-20D YAMA-20I YAMA-22DP YAMA-22IP YAMA-23DP YAMA-23IP YAMA-24DP YAMA-24IP YAMA-28P YAMA-29P	YAMA-18D YAMA-18I YAMA-19D YAMA-19I YAMA-20D YAMA-20I YAMA-22DP YAMA-22IP YAMA-23DP YAMA-23IP YAMA-24DP YAMA-24IP YAMA-28P YAMA-29P	YAMA-18D YAMA-18I YAMA-19D YAMA-19I YAMA-20D YAMA-20I YAMA-22DP YAMA-22IP YAMA-23DP YAMA-23IP YAMA-24DP YAMA-24IP YAMA-28P YAMA-29P	YAMA-18D YAMA-18I YAMA-19D YAMA-19I YAMA-20D YAMA-20I YAMA-22DP YAMA-22IP YAMA-23DP YAMA-23IP YAMA-24DP YAMA-24IP YAMA-28P YAMA-29P	YAMA-18D YAMA-18I YAMA-19D YAMA-19I YAMA-20D YAMA-20I YAMA-22DP YAMA-22IP YAMA-23DP YAMA-23IP YAMA-24DP YAMA-24IP YAMA-28P YAMA-29P
	DT 125 CO. DT 125 LC. DT 125 R	86-92 86-92 86-91	ZA-1 ZA-1P	ZA-1 ZA-1P	YAMA-18D YAMA-18DP YAMA-18I YAMA-18IP YAMA-19D YAMA-19DP	YAMA-18D YAMA-18DP YAMA-18I YAMA-18IP YAMA-19D YAMA-19DP	YAMA-18D YAMA-18DP YAMA-18I YAMA-18IP YAMA-19D YAMA-19DP





MARCA	MODELO						
			YAMA-22DP			YAMA-22DP	YAMA-22DP
	GTS 1000 GTS 1000 ABS YZF 750 R YZF 750 SP	93- 93- 93- 93-	YAMA-26 YAMA-26P	YAMA-26 YAMA-26P	YAMA-26 YAMA-26P	YAMA-26 YAMA-26P	YAMA-26 YAMA-26P
	RD 50 M XT 50	- -	YAMA-14D YAMA-14I	YAMA-14D YAMA-14I			
	RD 350	-	YAMA-3D YAMA-3I YAMA-9D YAMA-9I	YAMA-3D YAMA-3I YAMA-9D YAMA-9I	YAMA-17D YAMA-17I	YAMA-17D YAMA-17I	YAMA-17D YAMA-17I
	RD 500 LC XJ 550 XS 400	84- 84- 84-	YAMA-18D YAMA-18DP YAMA-18I YAMA-18IP YAMA-19D YAMA-19DP YAMA-19I YAMA-19IP YAMA-20D YAMA-20I YAMA-20IP YAMA-21I YAMA-21IP YAMA-22DP YAMA-22IP YAMA-23DP YAMA-23IP YAMA-24DP YAMA-24IP YAMA-28P YAMA-29P	NE-8 YAMA-21I YAMA-21IP	YAMA-18D YAMA-18DP YAMA-18I YAMA-18IP YAMA-19D YAMA-19DP YAMA-19I YAMA-19IP YAMA-20D YAMA-20I YAMA-20IP YAMA-21I YAMA-21IP YAMA-22DP YAMA-22IP YAMA-23DP YAMA-23IP YAMA-24DP YAMA-24IP YAMA-28P YAMA-29P	YAMA-18D YAMA-18DP YAMA-18I YAMA-18IP YAMA-19D YAMA-19DP YAMA-19I YAMA-19IP YAMA-20D YAMA-20I YAMA-20IP YAMA-21I YAMA-21IP YAMA-22DP YAMA-22IP YAMA-23DP YAMA-23IP YAMA-24DP YAMA-24IP YAMA-28P YAMA-29P	YAMA-18D YAMA-18DP YAMA-18I YAMA-18IP YAMA-19D YAMA-19DP YAMA-19I YAMA-19IP YAMA-20D YAMA-20I YAMA-20IP YAMA-21I YAMA-21IP YAMA-22DP YAMA-22IP YAMA-23DP YAMA-23IP YAMA-24DP YAMA-24IP YAMA-28P YAMA-29P
	RS 125 C.	-86	YAMA-5D YAMA-5I	YAMA-5D YAMA-5I			
	SR 500 G SR 500 S XT 500	79-84 79-84 79-84	YAMA-14I	NE-8	YAMA-14I		YAMA-14D YAMA-14I
	TDM XT 600 E XTZ 660 XVS 650 XVZ 1300 YP 250 MAJES YZF 600 YZF 1000	96- 96- 96- 96- 96- 96- 96- 96-	YAMA-26P		YAMA-26P	YAMA-26P	YAMA-26P
	TDR 125 TDR 125 R	92- 92-	YAMA-18I YAMA-18IP	ZA-1 ZA-1P	YAMA-18I YAMA-18IP	YAMA-18I YAMA-18IP	YAMA-18I YAMA-18IP
	TDR 125 R	90-91	YAMA-19I YAMA-19IP	ZA-1 ZA-1P	YAMA-19I YAMA-19IP	YAMA-19I YAMA-19IP	YAMA-19I YAMA-19IP

MARCA	MODELO						
	TRX 850 XVS 110 D.S.	95 98	YAMA-26DP	YAMA-26DP	YAMA-26DP	YAMA-26DP	YAMA-26DP
	TT 600 TT 600 E TZR 125 R XT 600 A XT 600 A XT 600 E	94 94 92- 93- 94 94	YAMA-20D	YAMA-20D	YAMA-20D	YAMA-20D	YAMA-20D
	TT 600 XT 600 A	95 95	YAMA-20I YAMA-24IP YAMA-28P	YAMA-20I YAMA-24IP YAMA-28P	YAMA-20I YAMA-24IP YAMA-28P	YAMA-20I YAMA-24IP YAMA-28P	YAMA-20I YAMA-24IP YAMA-28P
	TX 650 TX 750	79- 79-	YAMA-3D YAMA-3I	YAMA-3D YAMA-3I	YAMA-3D YAMA-3I	YAMA-3D YAMA-3I	YAMA-3D YAMA-3I
	V MAX 86 VMX 12 N XZV 12 T XZV 12 TD XZV 13 TD	84- 84- 84- 84- 84-	YAMA-21I YAMA-21IP	YAMA-21I YAMA-21IP	YAMA-18D YAMA-18DP YAMA-18I YAMA-18IP YAMA-22DP YAMA-22IP	YAMA-18D YAMA-18DP YAMA-18I YAMA-18IP YAMA-22DP YAMA-22IP	YAMA-18D YAMA-18DP YAMA-18I YAMA-18IP YAMA-22DP YAMA-22IP
	XC 125 CYGN.	95	YAMA-18D YAMA-22DP	YAMA-18D YAMA-22DP			
	XS 500	79-	YAMA-13D YAMA-13I	YAMA-13D YAMA-13I	YAMA-14I		
	XS 500 B	79-	YAMA-3D YAMA-3I YAMA-9D YAMA-9I	YAMA-3D YAMA-3I YAMA-9D YAMA-9I		YAMA-13D YAMA-13I	YAMA-13D YAMA-13I
	XS 500 EV.	85-	YAMA-13D YAMA-13I	YAMA-13D YAMA-13I		YAMA-13D YAMA-13I	YAMA-13D YAMA-13I
	XS 750	79-	YAMA-13I	YAMA-13I	YAMA-13I	YAMA-13I	YAMA-13I
	XS 1100 XS 1100 S	84- 84-	YAMA-13D YAMA-13I	NE-8	YAMA-13D YAMA-13I	YAMA-13D YAMA-13I	YAMA-13D YAMA-13I
	XT 250 YPUS 125	90- 90-	YAMA-17I	NE-8	YAMA-17I	YAMA-17I	YAMA-17I
	XT 400	-	YAMA-14D	NE-8	YAMA-14D		
	XT 600 E	95	YAMA-20I YAMA-24IP YAMA-26P YAMA-28P	YAMA-20I YAMA-24IP YAMA-26P YAMA-28P	YAMA-20I YAMA-24IP YAMA-26P YAMA-28P	YAMA-20I YAMA-24IP YAMA-26P YAMA-28P	YAMA-20I YAMA-24IP YAMA-26P YAMA-28P
	YSR 50	90-	YAMA-18D YAMA-18I YAMA-22DP YAMA-22IP	NE-8			

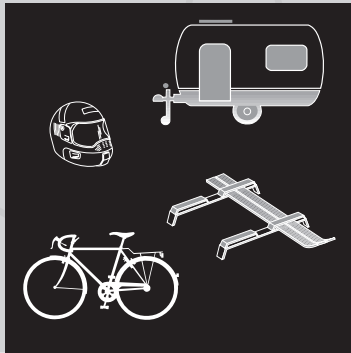
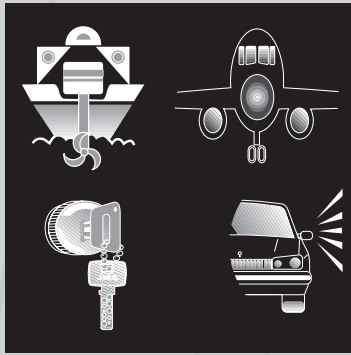



**JMA** 





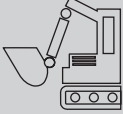

REFERENCIA	TIPO
ALP-1D ALP-1I ALP-2 CHI-1T COB-1P COB-2 DOM-11D NE-60C1 NE-60C2 PO-2P STS-X5 STS-X6 VA-61C1 VA-61C2 ZA-3D	ALARMA 
CN-1D MIT-1I MIT-1IP MIT-2I MIT-2IP TOYO-25 YA-11D YA-11I YA-27 YA-27D	AVIÓN 
ABU-13 ABU-13D ABU-3 ABU-40 ABU-45 AF-19 AF-19P AS-17D AS-21 AS-21D AS-21DP AS-21P AS-2D AS-2I AX-1 AX-1D AX-1DP AX-1P CI-4DP CI-4IP CI-5DP CI-5IP COB-1P COB-2 FAR-1D FAR-1I FAR-2D FAR-2I FAR-3 FAR-3D FAR-4D IMS-5 IMS-5P LAS-4 LAS-5 LAS-5D LAS-6 LAS-6D LAS-KT LAS-TK LF-15 LF-15D LF-1D LF-1I LF-5 LUMA-1D	BICICLETA 

REFERENCIA	TIPO
LUMA-1I LUMA-2D LUMA-2I LUMA-3D LUMA-3I LUMA-4D LUMA-4I MQ-1D MQ-1I NE-30 NE-30P NE-31 NE-31P NE-32 NE-32P RI-1D RI-1I RI-2D RI-2I RI-3D RI-3I STS-X6 TOK-4D UN-1FS UN-2 UN-3 UN-4 UN-FFE UN-FK UN-FP UN-FR UN-FS UN-MRN UN-NG VI-4DP VI-4IP YA-11D YA-11I ZA-1 ZA-10 ZA-1P ZA-3D ZA-4DP	BICICLETA 
AF-19 AF-19P AF-21 AF-21P DOM-3D DOM-3I DOM-6D DOM-6I EX-1D FAB-1 GH-CX GH-HX HU-SY IMS-3 IMS-3P IMS-5 IMS-5P JUNI-2D LF-15 LF-15D LF-1D LF-1I LF-5 LF-6 NE-6 NE-6P UN-1FS UN-2	CARAVANA 

REFERENCIA	TIPO
UN-3 UN-44 UN-44D UN-FFE UN-FK UN-FP UN-FR UN-FS UN-FT UN-MRN UN-NG VO-N VO-NP VO-R WA-5DP WA-5IP WAS-1 WAS-7I WAS-9 WAS-9D YA-11D YA-11I YA-27 YA-27D	CARAVANA 
AF-8D AF-8DP AF-8I AF-8IP AF-9D AF-9DP AF-9I AF-9IP BH-1 BH-1P BH-2 BH-3 BH-4 BH-5 DAE-5P DAV-1 DAV-1P FIA-1 MERI-1DP PRE-1I TEU-1 TOYO-27	CARRETILLA ELEVADORA 
AF-8D AF-8DP AF-8I AF-8IP AF-9D AF-9DP AF-9I AF-9IP BH-1 BH-1P BH-2 BH-3 BH-4 BH-5 DAE-5P DAV-1 DAV-1P FIA-1 MERI-1DP PRE-1I TEU-1 TOYO-27	CORTA CESPED 

REFERENCIA	TIPO
AF-8D AF-8DP AF-8I AF-8IP AF-9D AF-9DP AF-9I AF-9IP BH-1 BH-1P BH-2 BH-3 BH-4 BH-5 CAT-1P DAE-5P DAV-1 DAV-1P FIA-1 MERI-1DP PRE-1I TEU-1 TOYO-27	<p>ESCAVADORA</p> 
BAS-4 BH-1 BH-1P BK-4 BK-4D BK-5D BK-5I BS-1I BS-4D BS-7 BS-7D BS-8 BS-8D BS-9 BS-9D CHI-1 CHI-2 CHI-3 CHI-4 CHI-5 CLU-1D CLU-1I CLU-3 CLU-4 CLU-5 HUD-1 HUD-1D KEN-1 KEN-1D MIT-1I MIT-1IP MIT-2I MIT-2IP NE-1 NE-1D NE-1DP NE-1P NE-58D PLL-1 WST-1D WST-2D YA-11D YA-11I YA-27 YA-27D YA-37 YA-37D YA-8D YA-8I	<p>MOTOR MARINO</p> 

REFERENCIA	TIPO
AF-19 AF-19P AF-21 AF-21P AF-5D AF-5I AF-6D AF-6I BL-2 BL-3 BL-4 BL-4D ECH-1 FAB-1 FAR-1D FAR-1I FAR-2D FAR-2I GIU-1 GIU-1D GIU-2 GIU-2D IMS-3 IMS-3P IMS-5 IMS-5P RO-5I SI-1D SI-2D SI-3 SI-3D SI-4D VO-1 ZA-4DP	<p>PORTA ESQUIS</p> 
AB-6I AB-7I AB-8I AF-19 AF-19P AF-21 AF-21P AF-5D AF-5I AF-6D AF-6I BL-5 BL-5D CAM-1D CLI-1D DAR-1 FAB-1 FAB-2 FAR-1D FAR-1I FAR-2D FAR-2I FAR-3 FAR-3D FAR-4D FIA-2 GAS-1 GAS-1D GIOB-1D GIOB-1DP GIOB-2I GIOB-2IP HA-1D HA-1I HU-P IMS-3 IMS-3P IMS-5	<p>TAPÓN DE GASOLINA</p> 

REFERENCIA	TIPO
IMS-5P LAS-FH LAS-R LAS-V LAS-X LAS-Y NE-21P PJ-1 PJ-2 PJ-2P PJ-3 PJ-K PJ-KP SI-1D SI-2D SI-3 SI-3D SI-4 SI-4D SI-5D VO-1 VO-6D WAS-1 WAS-3 WAS-3P WAS-4 WAS-4P WAS-5 WAS-5P WAS-6 WAS-6P WAS-8 WAS-8D	<p>TAPÓN DE GASOLINA</p> 
AF-8D AF-8DP AF-8I AF-8IP AF-9D AF-9DP AF-9I AF-9IP BH-1 BH-1P BH-2 BH-3 BH-4 BH-5 CAT-1P DAE-5P DAV-1 DAV-1P FIA-1 MERI-1DP PRE-1I TEU-1 TOYO-27	<p>TRACTOR</p> 

AZK TALDEA 30.000-2.00CE



**ALEJANDRO ALTUNA, S.A.**

Bidekurtzeta, 6 Apdo. 70  
20500 ARRASATE-MONDRAGÓN  
(Gipuzkoa) ESPAÑA  
Tel. + 34 943 79 30 00 / 79 33 32  
Fax. + 34 943 79 72 43  
<http://www.jma.es>  
e-mail: [jma@jma.es](mailto:jma@jma.es)



Tél. 04 73 84 84 94